



DRESS
YOUR
SPACE

 Resol

 **Resol**
Dress Your Space

Nuestras creaciones nacen de la pasión, el ingenio e inspiración

La belleza siempre nace en la inspiración.

Es consecuencia de la libertad. Brota en los sueños. Pero deseamos verla, tocarla, admirarla. Es elocuente. Llena nuestros sentidos. Impacta en el pensamiento. Desencadena una emoción. Nos indica un camino, muy dentro, en nuestro interior. Alienta la aventura de sentirse vivo. Nos señala que hay un futuro, la alternativa de una vida emocionante. Nos impulsa y nos eleva. Sabemos que la belleza se manifiesta como quiere y que cada uno decide cuándo lo es. Que cada uno puede verla como quiera. Sólo responde ante la ley del deseo. Un deseo que es sólo tuyo. Nada fácil de colmar. Y eso no tiene fin porque a la belleza se la ama o, al menos, se la admira más allá de los tiempos en que fue concebida.

Aquí no nos limitamos a vestir tus espacios con belleza. Hacemos mucho más que idearla. **Nos encargamos de la materialización del sueño original, de la plasmación de un concepto de belleza con sus formas, sus colores y sus texturas.** De todo eso están hechas en realidad las creaciones que te acompañarán en tus distintos espacios: en tu vida, en tu trabajo, dónde vayas o dónde te muevas.

Estamos persuadidos del poder de comunicación que el diseño tiene para expresar la personalidad, las emociones e incluso para ayudar a crear estados de ánimo en las personas. Ésta es una vida con alternativas para asentarse o para ser nómada pero sobre todo para vivirla. Porque en el mundo actual, los espacios son más flexibles que nunca y pueden ser tanto un entorno social como un refugio, colectivo o individual, universal o personal.

Todas nuestras colecciones expresan este tipo de dualidad que fomenta las conexiones entre las personas y su espacio **y es también la clave de nuestro éxito.**

La nómina de diseñadores incluye a creadores del prestigio de **Josep Llusçà, Joan Gaspar, Jorge Pensi, David Carrasco Barceló y Monica Armani.**





Our creations are born from passion, ingenuity and inspiration

Beauty is always born from inspiration. It's a result of freedom. It blossoms in dreams. But we want to see it, touch it, admire it. It's eloquent. It fills our senses. It affects thought. It triggers an emotion. It shows us a path, deep down inside us. It stimulates the adventure of feeling alive. It shows us that there's a future, the alternative of an exciting life. It drives us and lifts us. We know that beauty manifests itself the way it wants and that everyone decides when. That everyone can see it as they wish to. It answers only to the law of desire. A desire that's yours alone. Not easy to fulfil. And this is never-ending, because beauty is loved or, at least, admired beyond the times when it was conceived.

Here we don't limit ourselves to decorating your spaces with beauty. We do much more than devise it. **We materialise the original dream, we embody a concept of beauty with its shapes, its colours and its textures.** The creations that will be your companions in your different spaces are in fact born from this: in your life, in your work, where you go or wherever you move.

We are convinced of design's power of communication to express personality, emotions, and even to help create moods in people. This is a life with alternatives for settling down or being a nomad but, above all, for living it. Because in today's world, spaces are more flexible than ever, and they may be a social setting like or a refuge, either collective or individual, universal or personal.

All our collections express this type of duality that foments the connections between people and their space, **and is also the key to our success.**

Our designers include prestigious creators such as **Josep Llusca, Joan Gaspar, Jorge Pensi, David Carrasco Barceló and Monica Armani.**

Nos créations sont le fruit de notre passion, de notre ingéniosité et de notre inspiration

La beauté naît toujours de l'inspiration. C'est le fruit de la liberté. Elle jaillit dans les rêves. Mais, nous voulons la voir, la toucher, l'admirer. C'est éloquent. Elle remplit nos sens. Elle agit sur nos pensées. Elle suscite une émotion. Elle pointe à l'intérieur de nous, au plus profond de notre être. Elle privilégie l'aventure de se sentir vivant. Elle nous rappelle que le futur nous est ouvert, l'alternative d'une vie passionnante. Elle nous fait avancer et nous hisse au plus haut. Nous savons que la beauté s'exprime librement et que tout un chacun détermine quand cela arrive. Pour que chacun puisse la voir à sa façon. Elle répond uniquement à la loi du désir. Un désir qui n'appartient qu'à vous seul. Pas facile de satisfaire. Et ce phénomène ne cesse de s'amplifier, car la beauté se fait aimer ou, du moins, admirer bien au-delà de l'époque à laquelle elle a vu le jour.

Chez nous, on ne se limite pas à habiller vos espaces de beauté. Nous allons bien au-delà de la conception. **Nous veillons à matérialiser le rêve original, à concrétiser un concept de beauté par ses formes, ses couleurs et ses textures.** Voilà de quoi sont faites les créations qui vous accompagneront dans vos différents espaces : dans votre vie comme dans votre travail, où que vous alliez ou que vous vous déplaciez.

Nous sommes convaincus du potentiel de communication du design pour exprimer la personnalité, les émotions et même pour aider à susciter des états émotionnels chez les personnes. Une vie avec des possibilités de se stabiliser ou de vivre en mode nomade, mais avant tout une vie pour la vivre. Car le monde actuel rend les espaces plus flexibles que jamais, pouvant être aussi bien un espace social qu'un foyer, collectif ou individuel, universel ou personnel.

Toutes nos collections expriment cette sorte de dualité qui favorise les connexions entre les personnes et leur espace, **ce qui constitue également la clé de notre succès.**

La liste des designers compte des créateurs de renom, notamment **Josep Llusca, Joan Gaspar, Jorge Pensi, David Carrasco Barceló et Monica Armani.**

Trabajamos centrados en la sostenibilidad del medioambiente adoptando el modelo de la economía circular

Desde el nacimiento de la compañía hace más de 60 años queremos trasladar a los objetos que fabricamos la vitalidad del tiempo contemporáneo abriéndonos a los materiales idóneos que marcan cada momento: **polipropileno, aluminio, acero, madera, plásticos 100% reciclados y reciclables, así como una extensa gama de tapicerías.** Con todo el impulso para dar respuesta a los desafíos y requisitos para el mejor diseño: muy bello, extraordinariamente útil y sin dejar de ser asequible.

Todo ello reforzando **nuestra apuesta por la sostenibilidad** que se traduce en la capacidad de recuperar el plástico que ha llegado al final de su vida útil para reciclarlo en nuevos productos con todas las garantías de calidad.

Esto es posible gracias al empleo de **GRITEK®**, un material formulado a raíz de un largo proceso de investigación realizado en Resol y que supone una gran innovación industrial. **GRITEK® está basado en un polímero polipropileno procedente de la recuperación de productos que han llegado al final de su vida útil y aditivado con fibra de vidrio también reciclada de procesos industriales.** Asimismo, se incorporan aditivos que alargan la vida del material reciclado y mejoran el aspecto del mismo. Este material es sometido a controles habituales de fluidez, esfuerzo mecánico y envejecimiento acelerado para asegurar el óptimo nivel de calidad con que nos identificamos. Con esta materia prima reciclada y regenerada en nuestras instalaciones, se fabrican íntegramente las referencias de la línea **Green Edition**, un lanzamiento que significa la culminación de un gran logro de Resol a favor de la sostenibilidad del planeta.

En todo este tiempo hemos ido dibujando un largo camino y podemos decir que nos inspiramos en la misma visión. La misma con la que fabricamos en 1985 la primera silla monocomponente de plástico -abriendo el paso a su futura circularidad- hasta lo más novedoso que generamos en la actualidad para la **colección Green Edition, donde reutilizamos el 100x100 de material reciclable postconsumo a través de nuestra innovadora fórmula GRITEK®,** manteniendo el listón de resistencia y elasticidad en todos nuestros productos, sin distinciones.



GRITEK®

GRITEK®

Polipropileno reciclado
post consumo de alta calidad



We work focused on the sustainability of the environment, adopting the circular economy model

Since the company was created over 60 years ago, we have aimed to endow the objects we produce with contemporary vitality by embracing the optimal materials that mark the moment: **polypropylene, aluminium, steel, wood, 100% recycled and recyclable plastics, as well as a broad range of upholsteries**. Fully galvanised to respond to the challenges and demands for the best design: very beautiful, extraordinarily useful, while at the same time affordable.

All of this boosting **our commitment to sustainability** which translates into the ability to recover the plastic that has reached the end of its useful life, to recycle it into new products with all the guarantees of quality.

This is made possible by using GRITEK®, a material formulated as the result of a long process of research conducted in Resol, and which represents a great example of industrial innovation. **GRITEK® is based on a polypropylene polymer that originates from**

the recovery of products that have reached the end of their useful lives, and with added glass fibre, also recycled from industrial processes.

Additives that lengthen the life of the recycled material and improves its look are also incorporated. This material is subjected to regular checks of fluidity, mechanical strain and accelerated aging, to guarantee the optimum quality level that identifies us. This raw material recycled and regenerated in our facilities is used entirely to manufacture the products in our Green Edition line, a launch that signifies the culmination of a great Resol achievement in favour of the sustainability of the planet.

Over all this time, we have been plotting a long path and we can say that we are inspired by the same vision. The same one with which in 1985 we produced the first mono-component plastic chair - opening the way to its future circularity - leading to the most innovative products we currently create for the **Green Edition collection, where we exclusively reuse post-consumer recyclable materials through our innovative GRITEK® formula**, upholding the standards of resilience and elasticity in all our products, without distinction.



Nous travaillons en privilégiant la durabilité environnementale sur la base du modèle de l'économie circulaire

Dès nos débuts, il y a plus de 60 ans, nous nous efforçons de conférer aux objets que nous fabriquons la vitalité de la vie contemporaine en ayant recours aux meilleurs matériaux disponibles à l'heure actuelle: **polypropylène, aluminium, acier, bois, plastiques 100% recyclés et recyclables, ainsi qu'une vaste gamme de revêtements intérieurs.** Avec toute la vigueur requise pour répondre aux défis et aux exigences du meilleur design: très beau, exceptionnellement pratique et pourtant à un prix abordable.

Ce faisant, nous renforçons **notre engagement en faveur de la durabilité**, qui se traduit notamment par la capacité de récupération du plastique devenu hors d'usage, puis de son recyclage pour la fabrication de nouveaux produits en offrant toutes les garanties de qualité.

Cela est rendu possible grâce à l'utilisation de GRITEK®, un matériau formulé sur la base d'un long processus de recherche mené par Resol et qui témoigne

d'une innovation industrielle de taille. **GRITEK® est fabriqué à partir d'un polymère de polypropylène provenant de la récupération de produits ayant atteint la fin de leur vie utile et enrichi de fibres de verre également recyclées au moyen de processus industriels.** Certains additifs sont également employés pour prolonger la durée de vie du matériau recyclé et améliorer son apparence. Ce matériau est soumis à des contrôles réguliers de fluidité, de résistance mécanique et de vieillissement avancé afin de satisfaire au niveau de qualité optimal qui nous caractérise. C'est avec cette matière première, recyclée et régénérée dans nos installations, que sont fabriquées toutes les références de la ligne Green Edition, un lancement qui représente le point culminant d'une grande réalisation de Resol en faveur du développement durable de la planète.

Au cours de ce processus, nous avons emprunté une longue trajectoire et pouvons affirmer que cette même vision a toujours été notre source d'inspiration. La même philosophie qui a présidé à la fabrication de la première chaise en plastique monocomposant en 1985 - ouvrant la voie à sa future circularité - jusqu'aux produits les plus innovants que nous créons actuellement pour **la collection Green Edition, où nous réutilisons à 100% des matériaux recyclables post-consommation grâce à notre formule innovante GRITEK®,** en maintenant le niveau de résistance et d'élasticité de tous nos produits, sans exception.



Nuestra fábrica

La fábrica empezó su actividad en 1961 en Olot para trasladarse a un centro de producción ubicado actualmente en la localidad de Les Preses, donde ocupa más de 40.000 metros cuadrados. Recientemente se ha ampliado la capacidad logística con la construcción de una nave de más de 6.000m². En este lugar se producen cerca de un millón de unidades al año entre tumbonas, sillas y mesas de diseño así como mobiliario de jardín.

En este centro se ha logrado implantar un proceso para la reutilización de toneladas de plástico postconsumo procedentes de otras industrias. Además, se recicla la totalidad del plástico postindustrial que se genera en los procesos de producción y acabado que se llevan a cabo en el propio centro.

Con todos estos materiales y empleando la tecnología de inyección con la fórmula GRITEK® para producir moldes, la factoría es capaz de crear nuevos productos basados en la excelencia. De este modo, somos un referente industrial en la aplicación de un modelo de economía circular.

Resol es líder reconocido en varios segmentos de mercado y una parte de nuestros clientes se encuentra más allá de nuestras fronteras en países como EE.UU, Francia, Reino Unido, Alemania, Emiratos Árabes, Brasil, México o en Australia. Resol ha vendido más de 50 millones de sillas a lo largo de su historia en todo el mundo.

Our factory

The factory went into production in 1961 in Olot, and later moved to a production centre currently located in the town of Les Preses, where it occupies over 40,000 square metres. It has recently extended its logistical capacity with the construction of an industrial plant of over 6,000m². This plant produces almost one million units a year, which include designer sunloungers, chairs and tables, as well as garden furniture.

A process for the reuse of tons of post-consumer plastic originating from other industries has been successfully implemented there. In addition, all the post-industrial plastic generated in the production and finishing processes carried out in the plant itself are recycled.

Using all these materials, along with the injection technology with the GRITEK® formula to produce moulds, the factory is capable of creating new products based on excellence. This has made us an industrial leader in the application of a circular economy model.

Resol is a recognised leader in several market segments, and some of our clients are located outside our borders, in countries such as the USA, France, the United Kingdom, Germany, the Arab Emirates, Brazil, Mexico and Australia. During its history, Resol has sold over 50 million chairs all over the world.

Notre usine

L'usine a démarré son activité en 1961 à Olot puis s'est déplacée vers un centre de production qui se trouve à ce jour dans la commune de Les Preses, où elle occupe plus de 40 000 mètres carrés. En outre, la capacité logistique a été récemment renforcée par la construction d'un entrepôt de plus de 6 000 m². On y produit environ un million d'unités par an, notamment des chaises longues, des chaises et des tables de design ou encore des meubles de jardin.

Ce centre a mis en place un processus de réutilisation de tonnes de plastique post-consommation provenant d'autres industries. Par ailleurs, tout le plastique postindustriel issu des processus de production et de finition réalisés dans le centre lui-même est recyclé.

Avec tous ces matériaux et en utilisant la technologie d'injection selon la formule GRITEK® pour la fabrication des moules, l'usine est en mesure de créer de nouveaux produits basés sur l'excellence. En ce sens, nous nous positionnons comme une référence industrielle dans l'application d'un modèle d'économie circulaire.

Resol est un leader incontesté dans plusieurs domaines du marché et certains de nos clients sont basés au-delà de nos frontières, notamment aux États-Unis, en France, au Royaume-Uni, en Allemagne, aux Émirats arabes unis, au Brésil, au Mexique ou en Australie. Au fil de son histoire, Resol a vendu plus de 50 millions de chaises dans le monde entier.



Más de 2.000 empresas han confiado en Resol.

More than 2.000 companies have trusted in Resol.

Plus de 2.000 entreprises ont fait confiance à Resol.



25 camiones al día. 3.000 al año.

25 trucks per day. 3000 per year.

25 camions par jour. 3000 par an.



Más de 50 millones de sillas vendidas.

More than 50 million chairs sold.

Plus de 50 millions de chaises vendues.



Exportamos a más de 110 países.

We export to more than 110 countries.

Nous exportons dans plus de 110 pays.



Disponemos de más de 40.000 m2 para actividad productiva.

We have more than 40.000 m2 for productive activity.

Nous avons plus de 40.000 m2 pour l'activité productive.



Productos 100% reciclables.

Products 100% recyclable.

Produits 100% recyclables.



Nueva nave para producto acabado.

New warehouse for finished product.

Nouvel entrepôt pour le produit fini.



Nuestros Diseñadores

Our Designers | Nos Designers



Josep Llusçà



Jordi Ribaudí



Javier Cuñado



Joan Gaspar



Joan Casas



David Carrasco Barceló



Jorge Pensi Studio



Monica Armani



Fabrizio Batoni

Premios

Awards | Prix



Ikona
If gold design Award 2021



Angie / Anou
If design Award 2021



Ikona / Angie / Anou
ADI - Delta de Bronce 2020



Ikona
Good Design Award 2019/2020



Toledo Aire
ADI - Delta de Plata 2018



Skin
Gold Award MIFF 2015



Vela
Winner Interior Innovation Award 2014



Vela
Excellence IIDA/HD Product Design 2014



Set Click-Clack
Platinum Award MIFF 2014



Beekat
Platinum Award MIFF 2013



Netkat
Excellence IIDA/HD Product Design 2012



Trama / Peach
Winner IIDA/HD Product Design 2011



Toledo
ADI - Delta de Plata 1988

Resol

Sigue puntualmente las novedades de la marca y accede a la información que necesitas de todas nuestras referencias en el portal **www.resol.es**

Follow the news of the brand on time and access the information that you need all our references in the portal **www.resol.es**

Suivez l'actualité de la marque à temps et accédez aux informations qui vous avez besoin de toutes nos références dans le portail **www.resol.es**

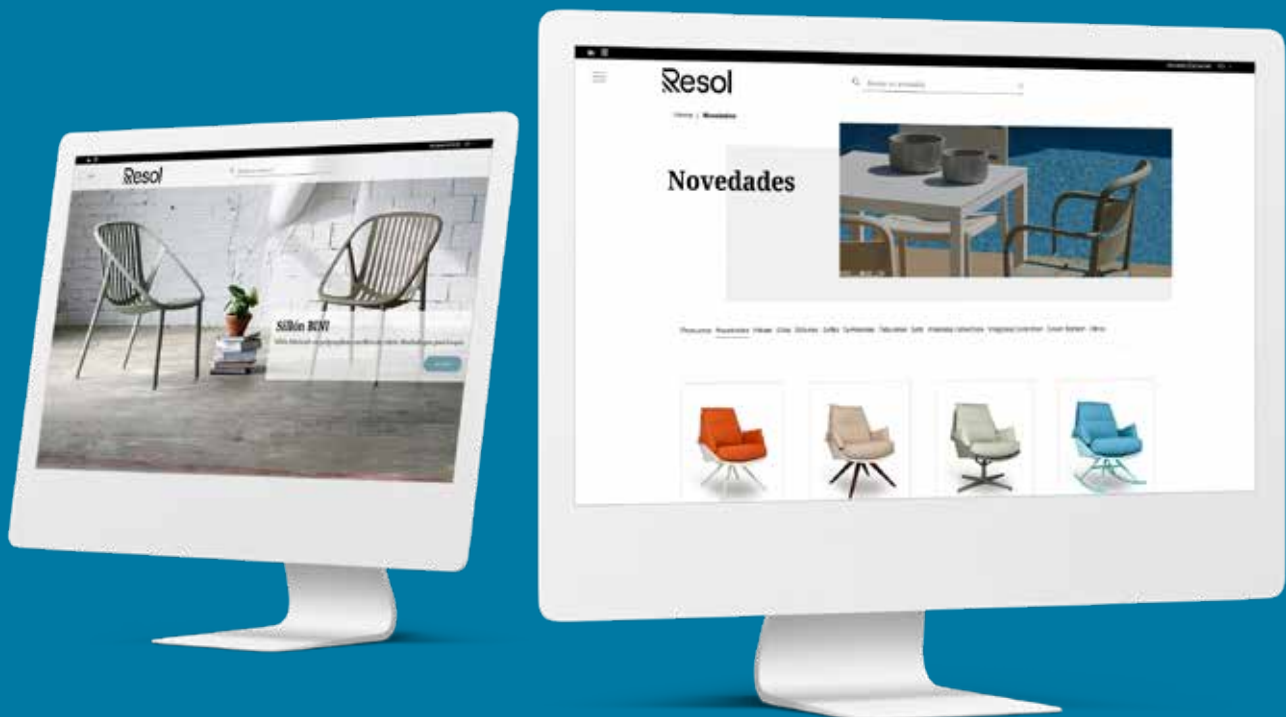

Extranet Resol

Regístrate en nuestro portal interno donde podrás descargar material gráfico como presentaciones corporativas, fichas técnicas, imágenes 2D, 3D y ambiente, certificados, imágenes de proyectos... ¡Y mucho más!

Para registrarte solo tienes que seguir estos pasos:

1. Entra a la web de Resol y haz click en "Acceso Extranet", que encontrarás en la esquina superior derecha.
2. Haz click en "Crear cuenta" y rellena tus datos.
3. Recibirás un email de confirmación con tu acceso.

Resol Extranet

You can register on our internal portal, where you'll be able to download graphic material such as corporate presentations, data sheets, 2-D and 3-D and environment images, images of projects... and much more!

To register, just follow these steps:

1. Go to the Resol website and click on "Extranet access", which you'll find in the top left-hand corner.
2. Click on "create account" and fill in your details.
3. You'll receive a confirmation email with your access.

Resol Extranet

Nous vous rappelons que vous pouvez vous inscrire sur notre portail interne où vous pourrez télécharger du matériel graphique tel que des présentations d'entreprise, fiches techniques, images 2D, 3D et d'ambiance, certificats, images de projets... Et bien plus encore !

Pour vous, il vous suffit de suivre ces étapes :

1. Entrez sur le site Web de Resol et cliquez sur « Accès Extranet » que vous trouverez dans le coin supérieur droit.
2. Cliquez sur « créer un compte » et remplissez vos coordonnées.
3. Vous recevrez un e-mail de confirmation avec votre accès.

 /Resol

 /Resol_furniture

 /Resolgrupo

www.resol.es





*Green
Edition*

Nuestros productos son
100% reciclables y 100% reciclados

Our products are
100% recyclable and 100% recycled

Nos produits sont
**100% recyclable et
100% recyclé**

 **Resol**



La línea sostenible fabricada con GRITEK®

Green Edition

#GreenThinking es el proyecto de **Resol** en el que desarrollamos nuevos procesos de innovación en materia de sostenibilidad y que ha dado como resultado la creación de **GRITEK®**, la fórmula que empleamos para fabricar la línea **Green Edition**, a partir de plástico reciclado que se encuentra al final de su vida útil.

El principal objetivo de nuestro proyecto es **eliminar la necesidad de disponer de plástico nuevo y cambiarlo completamente por plástico reciclado postconsumo.**

Así consolidamos un modelo de circularidad de los recursos materiales existentes que es muy beneficioso para la sostenibilidad del medioambiente.

De este modo, somos capaces actualmente de emplear la totalidad del plástico postconsumo generado en nuestra propia fábrica así como al material reciclado procedente de otras industrias que ha llegado hasta nuestro centro de producción a través del gestor de residuos.

GRITEK® es la materia prima reciclada y regenerada en nuestras instalaciones que significa la culminación de un gran logro de **Resol** a favor de la sostenibilidad del planeta.

Trabajamos para conseguir ciclos de vida infinitos de la materia prima que empleamos para producir.

Plástico reciclado postindustrial

Reutilizamos la totalidad de la materia sobrante generada en nuestros procesos de inyección en la fábrica.

Plástico reciclado postconsumo

A través del gestor de residuos, recogemos y gestionamos todo el plástico rechazado procedente de otras industrias o incluso de nuestros propios clientes para poder inyectarlo de nuevo como material reciclado para producir nuevos productos.

Los años de experiencia en inyección nos han permitido definir un proceso para darle uso a todo aquel plástico que ya había llegado al fin de su ciclo de vida. De esta manera, somos capaces de convertir materiales recolectados de la corriente de desechos en mobiliario reciclado.

Nuestro objetivo es optimizar al máximo los recursos disponibles y contribuir en la reutilización en la máxima escala posible de un material como el plástico que, si se gestiona y usa de forma correcta, debido a su durabilidad y procedencia, es una opción que contribuye claramente a favorecer un modelo de sostenibilidad.

De ahí que, siendo capaces de basar la producción en un modelo de economía circular, somos una organización que está liderando el despliegue de este planteamiento dentro de nuestro sector.

Reinvent Recycle Resol

Green Edition

Hay algo mejor que reinventar tu hogar y tu oficina con muebles de diseño: hacerlo con muebles de diseño Resol Green Edition, de plástico 100% reciclado y reciclable.

Porque todos nos merecemos un futuro mejor. Incluso esta caja de plástico.



Silla Steely
Amarillo fuego



GRITEK®

Es una marca registrada por Resol. Una nueva fórmula (polipropileno reciclado posconsumo de alta calidad) que garantiza que nuestros productos Green Edition sean sostenibles y con las mismas prestaciones que los modelos fabricados con plástico nuevo.

Resol



www.resol.es

The sustainable line produced using GRITEK®

Green Edition

#GreenThinking is the **Resol** project in which we develop new innovation processes as regards sustainability, and has resulted in the creation of **GRITEK®**, the formula we use to produce the **Green Edition** line, based on recycled plastic that has reached the end of its useful life.

The main aim of our project is to **eliminate the need for new plastic and completely replace it with post-consumer recycled plastic.**

Thus we consolidate a model of circularity of the existing material resources that is highly beneficial for the sustainability of the environment.

Thus we are currently capable of using all the post-consumer plastic generated in our own factory, as well as the recycled material coming from other industries which has reached our production centre through the waste manager.

GRITEK® is the raw material recycled and regenerated in our facilities that signifies the culmination of a great **Resol** achievement in favour of the sustainability of the planet.

We work to achieve endless lifecycles of the raw materials we use in production.

Post-industrial recycled plastic

We reuse all the excess material generated in our injection processes in the factory.

Post-consumer recycled plastic

Through the waste manager, we collect and manage all the rejected plastic originating from other industries, or even from our own clients, so that we can inject it again as recycled material to manufacture new products.

Our years of experience in injection have enabled us to define a process to use all the plastic that has reached the end of its useful life. We are thus capable of converting materials recovered from the waste flow into recycled furniture.

Our goal is to optimise the available resources to the maximum and contribute as far as possible to the reuse of a material like plastic which, if properly managed and used, due to its durability and origin, is an option that clearly contributes to fostering a sustainability model.

Hence, our capability of basing production on a circular economy model has made us an organisation that is leading the deployment of this approach within our sector.

La ligne durable fabriquée à partir de GRITEK®

Green Edition

#GreenThinking est le projet de **Resol** au sein duquel nous développons de nouveaux processus d'innovation dans le domaine de la durabilité et qui a abouti à la création de **GRITEK®**, la formule que nous utilisons pour fabriquer la ligne **Green Edition**, à partir de plastique recyclé arrivé en fin de vie.

L'objectif principal de notre projet vise à **éliminer le besoin de plastique neuf et à le remplacer intégralement par du plastique recyclé post-consommation.**

De cette façon, nous consolidons un modèle de circularité des ressources matérielles existantes largement bénéfique pour la durabilité environnementale.

De ce fait, nous sommes actuellement en mesure d'utiliser tout le plastique post-consommation généré dans notre propre usine de même que les matériaux recyclés provenant d'autres industries qui sont parvenus à notre centre de production par l'intermédiaire du gestionnaire de déchets.

GRITEK® est la matière première recyclée et régénérée dans nos installations, fruit du grand exploit de **Resol** en faveur du développement durable de la planète.

Nous nous efforçons d'obtenir des cycles de vie infinis pour les matières premières que nous utilisons dans notre production.

Plastique recyclé post-industriel

Nous réutilisons en usine tous les surplus de matériaux générés lors de nos processus de moulage par injection.

Plastique recyclé post-consommation

Par l'intermédiaire de notre gestionnaire de déchets, nous récupérons et gérons tout le plastique rejeté par d'autres industries ou même par nos propres clients afin de pouvoir le réinjecter comme matériau recyclé pour fabriquer de nouveaux produits.

Des années d'expérience dans le domaine du moulage par injection nous ont permis de développer un processus pour exploiter tout le plastique ayant atteint la fin de son cycle de vie. Ainsi, nous sommes en mesure de transformer les matériaux collectés du flux de déchets en meubles recyclés.

Notre objectif est d'optimiser au maximum les ressources disponibles et de contribuer à la réutilisation à grande échelle d'un matériau comme le plastique qui, si sa gestion et son utilisation sont adéquates, en raison de sa durabilité et de son origine, est une option qui contribue incontestablement à favoriser un modèle de développement durable.

Aussi, en parvenant à ancrer notre production dans un modèle d'économie circulaire, nous nous positionnons comme une organisation à la pointe du déploiement de cette stratégie dans notre secteur.





Silla Tokio Green Edition



COMO DISEÑAR UNA SILLA

APARTE







Silla Woody Green Edition



Silla Toledo Aire Green Edition







Silla Spot Green Edition



Tapizados

Upholstered

Tapissé

 Resol



TAPIZADOS | UPHOLSTERED | TAPISSÉ

Resol, de la mano de algunas de las marcas más prestigiosas del textil para mobiliario y decoración interior, como:

Resol, together with some of the most prestigious textile brands for interior decor and furniture, such as:

Resol, en collaboration avec certaines des marques les plus prestigieuses de tissus d'ameublement et de décoration d'intérieur comme:

camira

Gabriel

crevin

SPRADLING®

ofrece una selección de tejidos y colores de estética refinada, contemporánea y de altas prestaciones. Distintas texturas y una gran gama de materiales capaces de crear una conexión emocional con el usuario y el entorno.

Cada tejido ha sido seleccionado cuidadosamente pensando en abarcar cualquier proyecto con garantías de calidad. Nuestra amplitud de gama ofrece una solución completa con tejidos que cubrirán todas las necesidades de decoración en proyectos de hotelería, restauración, oficinas y hogar; con la calidez y funcionalidad demandada en los espacios contract.

Seguimos fieles a nuestro compromiso **Green Thinking**  incorporando tejidos 100% reciclados y identificando puntos de mejora ambientales que nos han permitido ser galardonados con la UNE-EN ISO 14006 en ecodiseño.

offers a selection of fabrics and colours of a refined, contemporary and high-performance aesthetic. Different textures and a wide range of materials able to create an emotional connection with the user and the surroundings.

Each fabric has been carefully selected to perfectly cover any project ensuring the highest quality. Our broad range offers a complete solution with fabrics that will cover all the decoration needs for hotel, restaurant, office and home projects; with the warmth and functionality required for contract spaces.

We remain loyal to our **Green Thinking**  commitment, incorporating 100% recycled fabric and identifying environmental areas for improvement that have enabled us to receive the UNE-EN ISO 14006 standard in eco-design.

propose une sélection de textiles et de couleurs à l'esthétique raffinée, contemporaine et haut de gamme. Différentes textures et matières capables de créer un lien émotionnel avec le client et l'environnement.

Chaque tissu a été soigneusement sélectionné afin d'aborder chaque projet dans une démarche qualité. Notre vaste gamme de tissus permettra de couvrir tous les besoins de décoration de vos projets quels qu'ils soient (hôtellerie, restauration, bureaux, logements) avec tout le confort thermique et la fonctionnalité demandée dans les espaces de mobiliers contract.

Fidèles à notre compromis **Green Thinking**  nous avons incorporé des tissus 100 % recyclés et identifié certains aspects environnementaux à améliorer qui nous ont permis d'obtenir la certification UNE-EN ISO 14006 et d'intégrer l'éco-conception.





Sillón Shape tapizado









Silla Skin tapizada



Silla Skin tapizada



Silla Skin tapizada





Taburete Skin tapizado



Taburete Skin tapizado



Ambientes
Environments
Environnements

 Resol



Anthea

 indecasa
Collection



Design Monica Armani

« Distinguida colección para los espacios más selectos. ANTHEA no se puede definir como un complemento ya que su exquisito diseño convierte cada uno de sus elementos en el protagonista principal del entorno. Sus ingredientes fundamentales son el color, las soluciones para innovaciones textiles y la forma. Sofás, amplios sillones, sillas, y una innovadora poolbed, completados con una mesa lateral y mesita de café, son elementos perfectos tanto para interior como exterior. »

« A distinguished collection for the most select spaces, ANTHEA can't be defined as a complement, since its exquisite design turns each of its elements into the star of the setting. Its basic ingredients are colour, solutions for textile innovations, and form. Sofas, large armchairs, chairs, and an innovative pool bed, complete with a side table and coffee table, are perfect features for both indoors and outdoors. »

« Collection distinguée pour les espaces les plus huppées. ANTHEA ne peut pas se définir comme un complément puisque sa conception exquise transforme chacun de ses éléments en protagoniste principal du cadre. Ses ingrédients fondamentaux sont la couleur, les solutions pour les innovations textiles et la forme. Des canapés, de grands fauteuils, des chaises et un lit de piscine innovant, avec une table d'appoint et une table basse, sont des éléments parfaits pour l'intérieur et l'extérieur. »



Anthea Chair / Anthea Dining Table



Anthea Chair

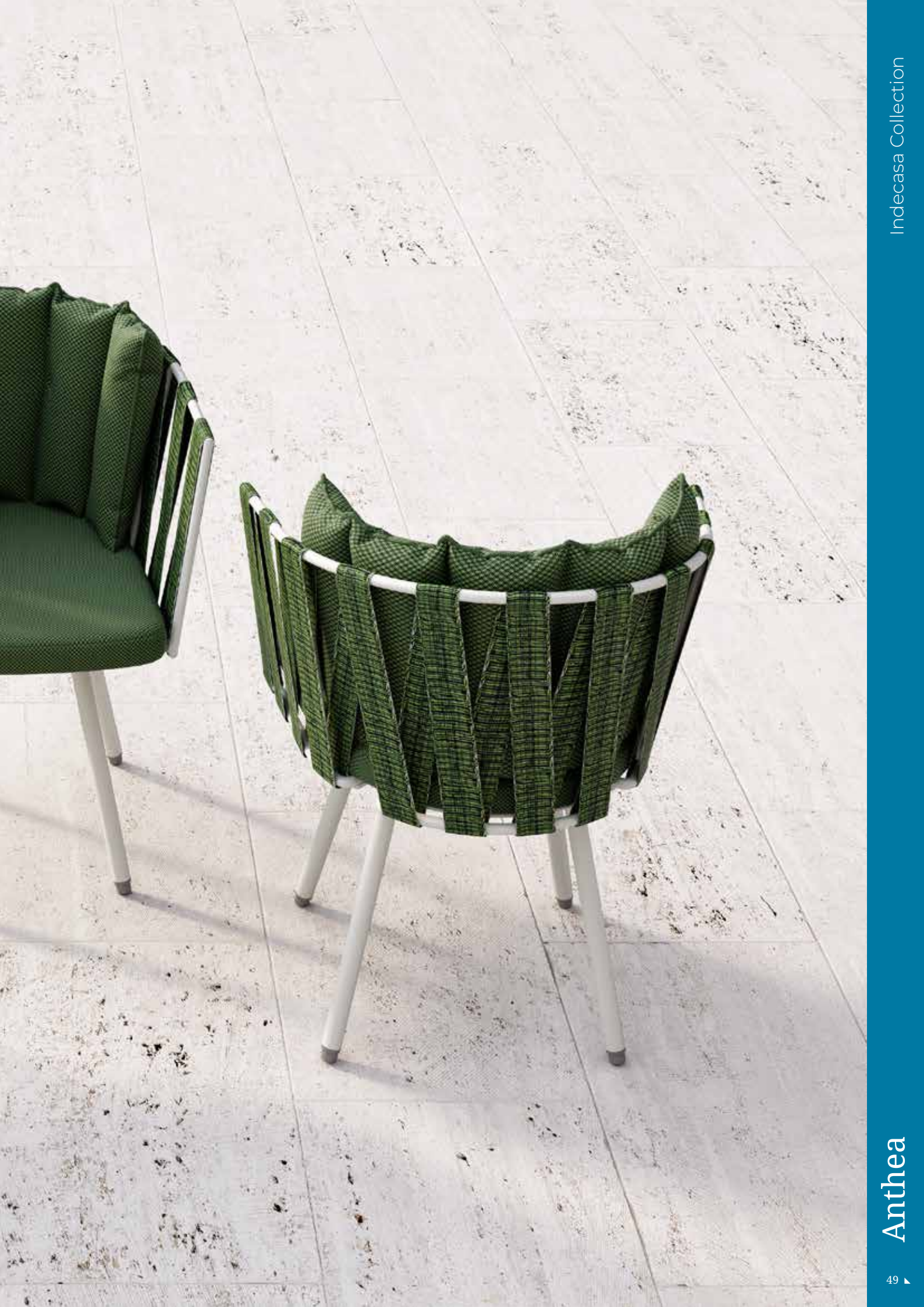









Anthea Chair / Anthea Dining Table









Anthea Sofa / Ottoman / Side Table



Anthea Sofa







Anou

 indecasa
Collection



Delta de Bronce
Premio ADI 2020

Design Jorge Pensi

« ANOU es la combinación perfecta de fuerza y suavidad. Diseño exclusivo con distintas combinaciones y estructuras según su finalidad. Las telas están hechas con gran detalle. »

« ANOU is the perfect combination of strength and softness. Exclusive design with different combinations and frames according to its purpose. The fabrics are produced with great attention to detail. »

« ANOU est la combinaison parfaite de force et de douceur. Design exclusif avec différentes combinaisons et structures en fonction de son usage. Les tissus sont fabriqués dans les moindres détails. »







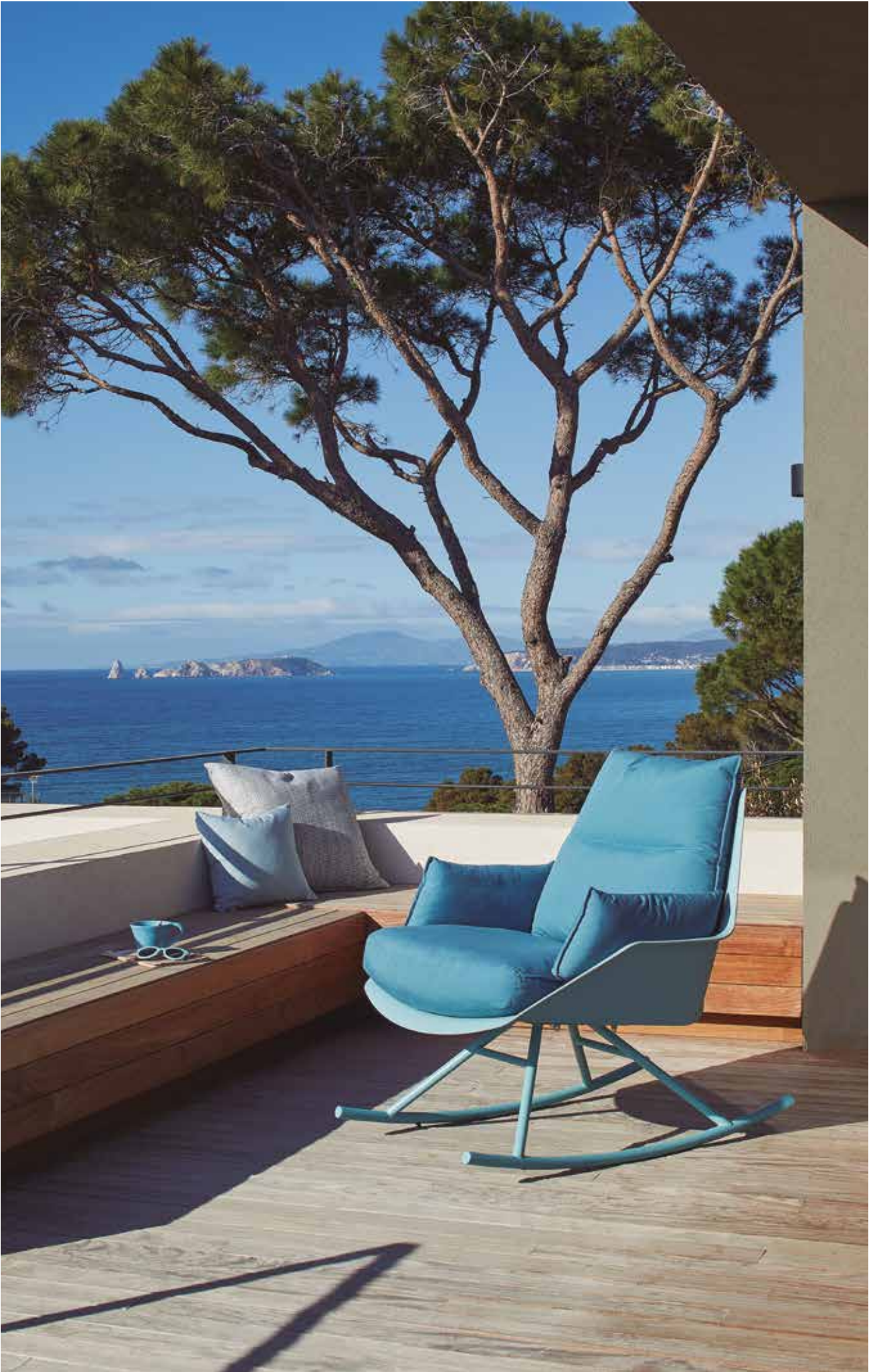





Espiga

 indecasa
Collection

h k h π π A

Design
Jordi Ribaudí

« Elegante, versátil... Esta solución es perfecta para cualquier ocasión. ESPIGA, su nombre la define. Fusionar lo funcional con lo emocional. Recuperar y hacer visible lo útil y lo bello de nuestra cultura para crear una colección que sorprende por atractivo ritmo geométrico a la vez que orgánico. En ella se refleja esa ancestral forma de tejer que siempre ha estado ahí, primitiva, sencilla, cercana y a la vez tan inteligente. »

« Elegant and versatile, this solution is perfect for any occasion. Its name ESPIGA (SPRIG in English) defines it. Merging the practical with the emotional. Recovering and revealing the useful and beautiful elements of our culture to create a collection that will surprise you with attractive, geometric and organic rhythm. It reflects that ancient way of weaving that has always been around - primitive, simple, intimate, but at the same time, highly intelligent. »

« Élégante, polyvalente... Cette solution est parfaite pour toutes les occasions. ESPIGA, son nom la définit. Fusionner le fonctionnel à l'émotionnel. Récupérer et rendre visible l'utilité et la beauté de notre culture pour créer une collection qui surprend avec un rythme attrayant aussi bien géométrique qu'organique. Il reflète cette ancienne façon de tisser qui a toujours été là, primitive, simple, proche et en même temps si intelligente. »





Silla Espiga / Silla con brazos Espiga

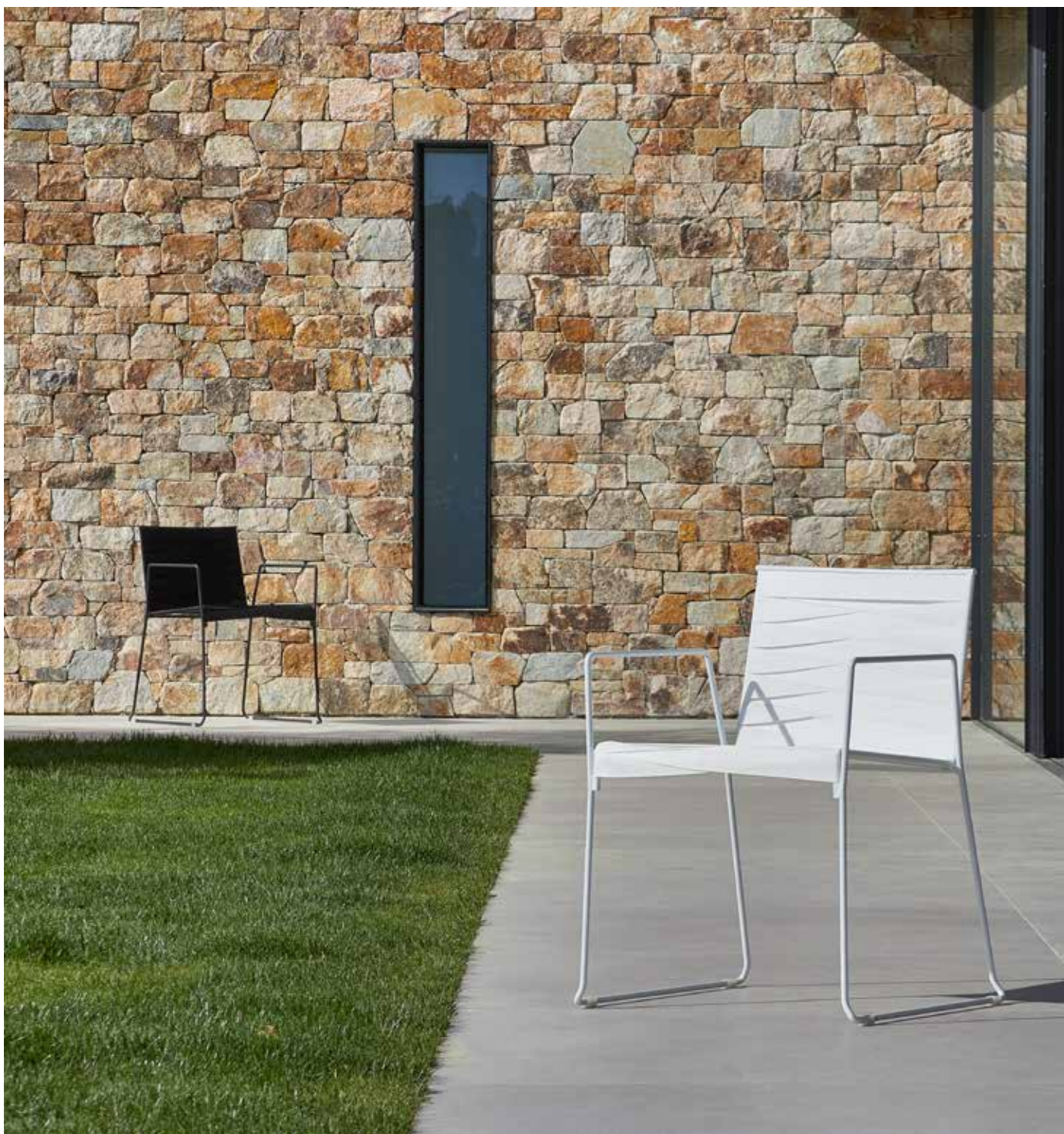

Silla con brazos Espiga



Silla Lounge Espiga / Mesa Auxiliar Espiga









Mesa Espiga / Silla Espiga / Taburete Espiga







Taburete Espiga

Dunas

 indecasa
Collection



Design
Jordi Ribaudí

« DUNAS es una colección de líneas redondeadas y amables diseñada para adaptarse a todos los entornos y climas. Con sus formas juveniles, ofrece una versatilidad y modernidad capaz de encajar en los lugares más insospechados. »

« DUNAS is a collection of rounded and friendly lines designed to adapt to all environments and climates. With its youthful forms, offers versatility and modernity able to fit in the most unsuspected. »

« DUNAS est une collection aux lignes arrondies et conviviales, conçue pour s'adapter à tous les cadres et climats. Avec ses formes jeunes, elle offre une polyvalence et une modernité capables de s'adapter aux endroits les plus inattendus. »







Sillón Dunas / Sofá Dunas / Mesa Reposapiés Dunas





Tumbona Dunas



Milano

 indecasa
Collection

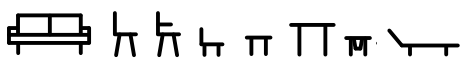

Design
Joan Gaspar

« MILANO, de línea sobria y elegante, confiere un aire distinguido a cualquier espacio. El estilo delicado y la máxima durabilidad de esta colección permiten su adaptación a entornos diferentes y singulares. Configura una amplia gama de elementos que permiten abastecer cualquier tipo de necesidades. »

« MILANO, a sober and elegant, gives distinguished touch to any space. The delicate style and maximum durability of this collection make it adaptable to different and unique environments. »

« MILANO, à la ligne sobre et élégante, apporte un air distingué à tout espace. Le style délicat et la durabilité maximale de cette collection lui permettent de s'adapter à des environnements différents et uniques. Elle forme un large éventail d'éléments qui permettent de répondre à tout type de besoins. »



Silla Milano / Silla con brazos Milano / Mesa Milano



Silla Milano / Silla con brazos Milano / Mesa Milano





Sillón Milano / Mesa Milano Ice Cube



Mesa Milano Ice Cube / Tumbona Milano









Lucca

 indecasa
Collection



Design
Joan Casas

« LUCCA es una colección selecta y versátil, con dimensiones y acabados diferentes en sus distintas variantes, con materiales nobles y de una durabilidad máxima. Diseñada para satisfacer las exigencias más lujosas, un diseño atemporal que se distingue por su elegancia en cualquier espacio. »

« LUCCA is a versatile, select collection, with different sizes and finishes in its different variants, with noble materials and maximum durability. Designed to satisfy the most luxurious demands, with a timeless design that is distinguished by its elegance in any space. »

« LUCCA est une collection de choix et polyvalente, sous différentes dimensions et finitions et différentes variantes, avec des matériaux nobles et une durabilité maximale. Conçue pour répondre aux exigences les plus luxueuses, avec un design intemporel qui se distingue par son élégance dans n'importe quel espace. »



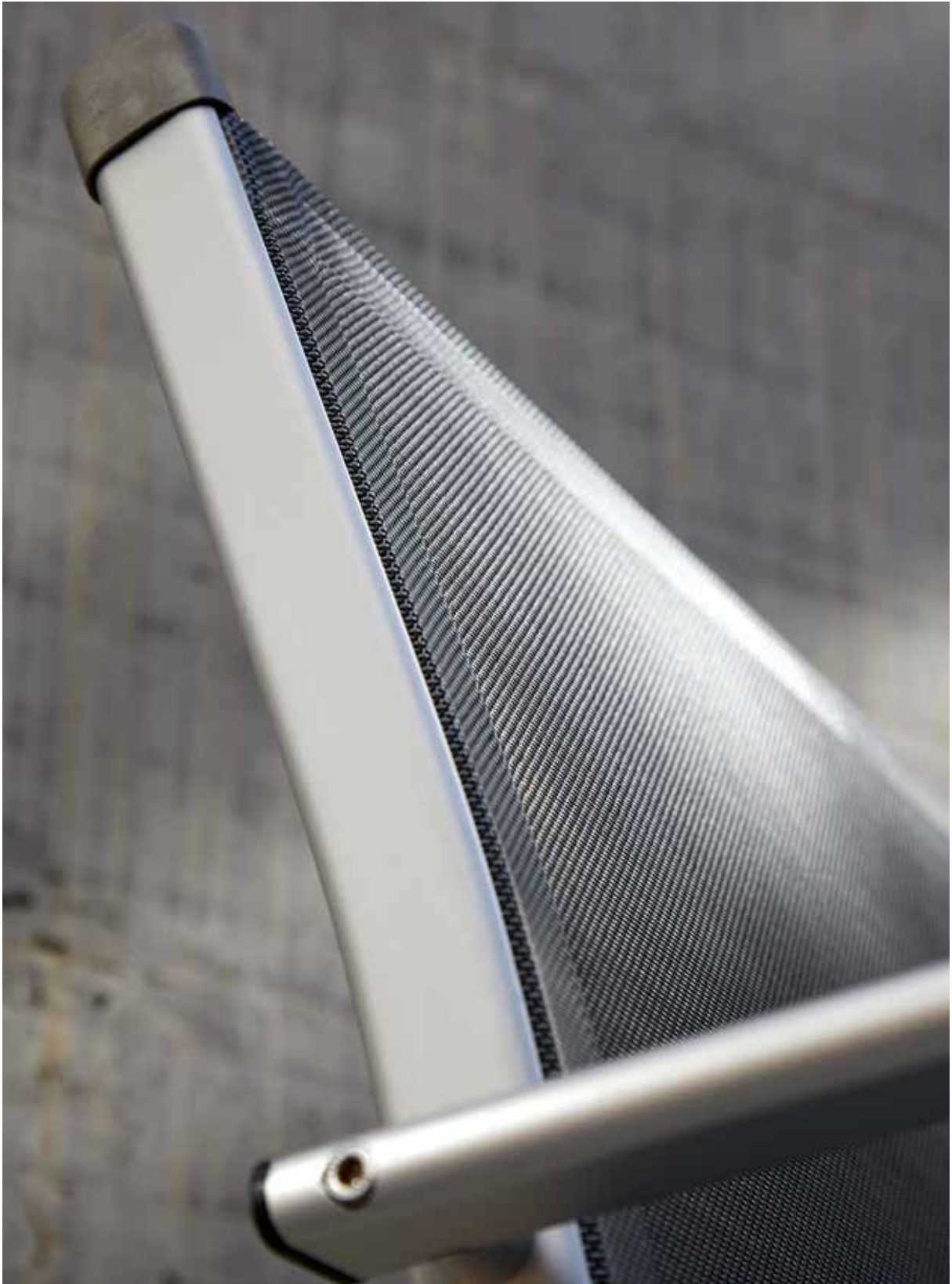

Silla con brazos Lucca 02







Tumbona Lucca 15 / Lucca 19 Ottoman

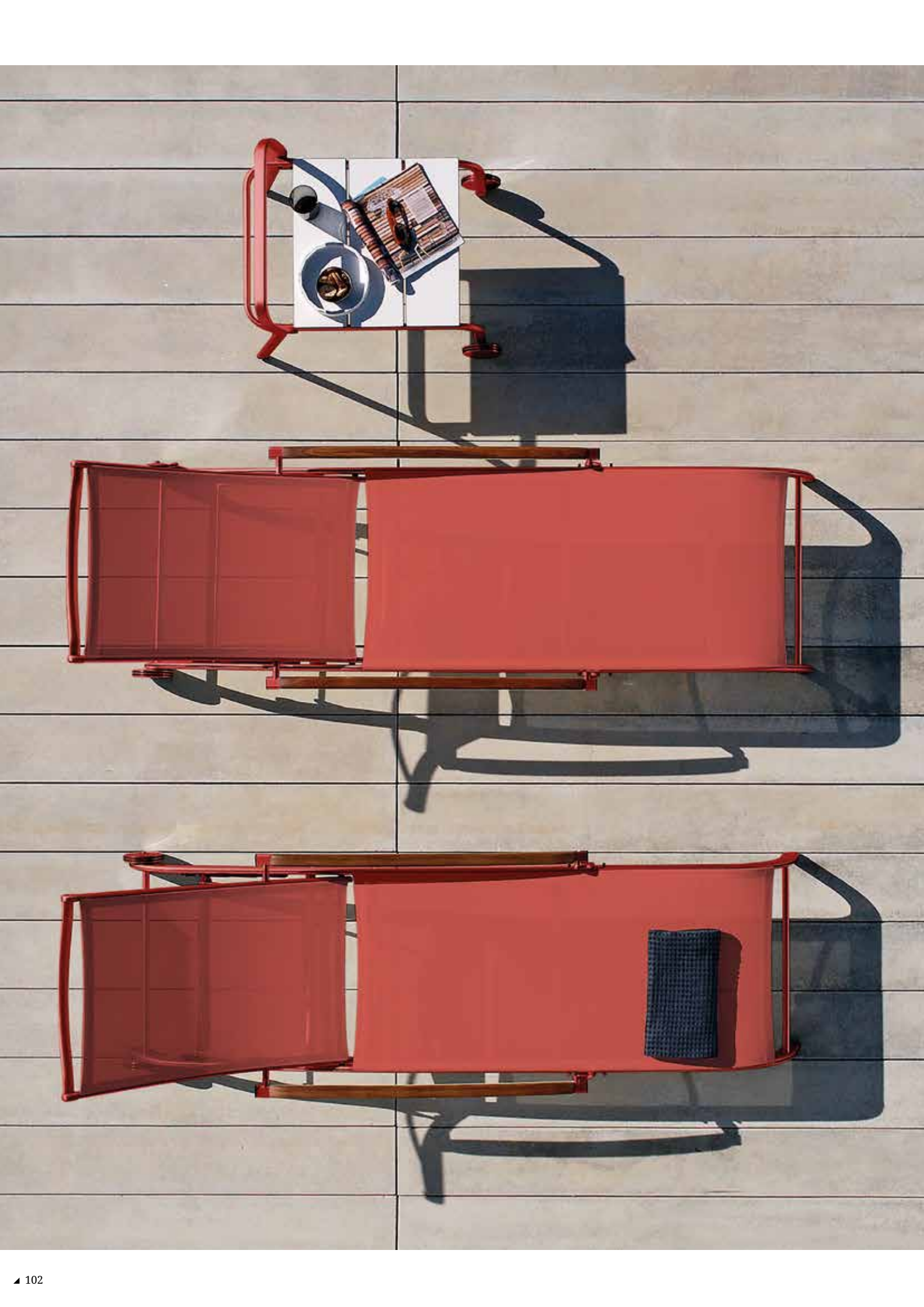



Tumbona Lucca S-32/ Carro Lucca 18

Siena, Dom + Domino

 indecasa
Collection

h k π

Design
Joan Casas

« La silla SIENA se distingue por la luz y la transparencia. La serie de mesas DOM significa fortaleza y diseño. Sus líneas limpias y bien definidas son capaces de brindar elegancia y sobriedad a cualquier espacio. DOMINO, de líneas suaves y compactas, desprenden carácter y sencillez. »

« The SIENA chair stands out due to its light and transparency. The DOM series of tables denotes strength and design. Its clean and well-defined lines are capable of bringing elegance and restraint to any space. The smooth and compact lines of DOMINO exude character and simplicity. »

« La chaise SIENA se distingue par sa lumière et transparence. La série de tables DOM est synonyme de solidité et design. Ses lignes épurées et bien définies sont capables d'apporter élégance et sobriété à n'importe quel espace. DOMINO, aux lignes douces et compactes, dégage caractère et simplicité. »



Silla con brazos Siena





Silla con brazos Siena



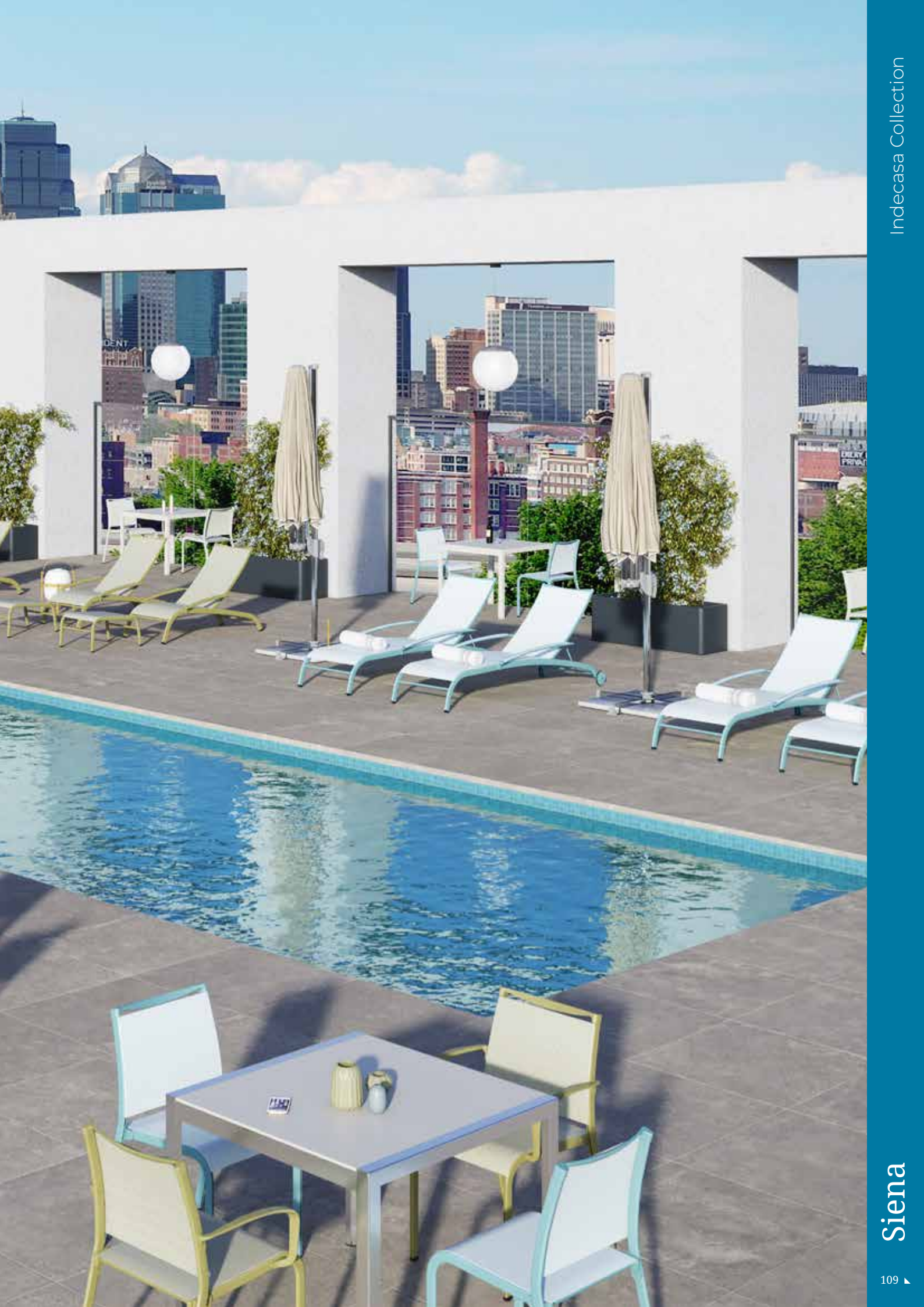



Mesa Domino







Mesa Dom

Sálvora

 indecasa
Collection



Design
Antoni Tarrés

« SALVORA es el nombre de una pequeña isla de la costa atlántica, considerada lugar sagrado por los antiguos pobladores celtas. SALVORA, una sunlounger con silueta de isla. Una línea simple, compacta, cómoda, robusta y deseable, con una elegancia incomparable. »

« SALVORA is the name of a small island on the Atlantic coast, considered to be a sacred place by ancient Celtic settlers. SALVORA, is a sun ounger with an island outline. A simple, compact, comfortable, strong and desirable line, with incomparable elegance. »

« SALVORA es el nombre de una pequeña isla de la costa atlántica, considerada lugar sagrado por los antiguos pobladores celtas. SALVORA, una sunlounger con silueta de isla. Una línea simple, compacta, cómoda, robusta y deseable, con una elegancia incomparable. »







Tumbona Salvora



Mesa Baja Salvora



Shape

Collection

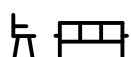

Design
Josep Llusçà

« SHAPE es un sillón que se caracteriza por la versatilidad gracias a su diseño ya que le permite personalizar múltiples modelos según tipologías de patas, colores y acabados. Su amplia variedad de versiones convierte a este diseño en una silla perfecta para convivir en distintos espacios. »

« SHAPE is an armchair that features versatility through its design, enabling you to customise numerous models according to leg types, colours and finishes. Its wide variety of versions makes this design a perfect chair to share

« SHAPE est un fauteuil qui se caractérise par sa polyvalence grâce à son design, car elle vous permet de personnaliser plusieurs modèles en fonction des types de pieds, couleurs et finitions. Sa grande variété de versions fait de ce design une chaise parfaite pour vivre dans différents espaces. »









Silla Shape











Silla Shape Tapizada





Angie

Collection

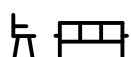

Delta de Bronce
Premio ADI 2020

Design
Josep Lluscà

« ANGIE tiene dos grandes adjetivos: comodidad y elegancia. Esta silla, con gran variedad de colores y acabados, es perfecta para ubicar en cualquier rincón del hogar. »

« Two great adjectives describe ANGIE - comfort and elegance. This chair, with a wide variety of colours and finishes, is perfect for installing in any corner of your home. »

« ANGIE se définit par deux grands adjectifs : confort et élégance. Cette chaise, avec une grande variété de couleurs et de finitions est parfaite pour être installée dans n'importe quel coin de la maison. »









Silla Angie

SALA 1





Skin

Collection



Gold Award
MIFF 2015

Design
Josep Llusçà

« Pensada para proporcionar el máximo confort, la colección SKIN dispone de una gran variedad de estructuras y tapizados para adaptar mejor el diseño del entorno. La variedad de estructuras hace que este diseño se integre en cualquier estancia. »

« Devised to provide maximum comfort, the SKIN collection features a wide variety of frames and upholstery to better adapt it to the design of the setting. The range of frames enables this design to fit in with any room. »

« Conçue pour offrir un maximum de confort, la collection SKIN dispose d'une grande variété de structures et de tissus d'ameublement pour mieux adapter la conception de l'environnement. La variété des structures permet à cette conception de s'intégrer dans n'importe quelle pièce. »







Silla Skin







Silla Skin con Mesa Auxiliar



Silla Skin Tapizada



New

Skin





Taburete Skin



Taburete Skin Tapizado





New

Skin





Wire

Collection

h h h

Design
Josep Llusçà

« El diseño de WIRE apuesta por un sutil equilibrio entre conceptos fundamentales como ligereza, transparencia, ergonomía y versatilidad. »

« The WIRE design is committed to a subtle balance between fundamental concepts such as lightness, transparency, ergonomics and versatility. »

« Le design de WIRE mise sur un équilibre subtil parmi des concepts fondamentaux comme la légèreté, la transparence, l'ergonomie et la versatilité. »









Silla Wire / Silla con brazos Wire



Taburete Wire



BOSS & Boss Soft



Design
Joan Gaspar

« De aspecto familiar y cercano, sin gritos formales, plegable y fácil de prescribir. BOSS transmite comodidad y bienestar. »

« Familiar and warm, free from abrasive forms, foldable and easy to prescribe. BOSS transmits comfort and well-being. »

« D'aspect familial et proche, sans lignes formelles, pliable et facile à prescrire. BOSS transmet commodité et bien-être. »





Silla con brazos Boss Soft



Silla con braccioli Boss Soft

Bini

Collection

h h π π

Design
Joan Gaspar

« Bini formalmente nos remite a las sillas de caña, retenidas en la memoria a lo largo de los años. Se presenta en dos versiones, un sillón bajo y una silla. Ambas versiones, sillón y silla, disponen de la posibilidad de hacer conjunto con una mesa redonda, disponible en dos alturas que ayuda a la composición del conjunto. »

« Bini formally speaking, it recalls that cane chair so familiar to us over the years. It comes in two versions, a low armchair and upright chair. Both versions, chair and armchair, match with a round table available in two heights to help in composing the furniture arrangement. »

« Bini nous fait penser aux chaises en roseau, que l'on garde en mémoire au fil des ans. Elle se présente en deux versions, un fauteuil bas et une chaise. Les deux versions disponibles avec chaises ou fauteuils et notre table ronde. Disponible en 2 hauteurs ce qui permet de faire plusieurs compositions d'un même ensemble. »

New







Silla Bini / Mesa Bini





New

Bini



Mesa Bini Lounge / Sillón Bini Lounge







New

Bini

Silla Bini / Mesa Bini / Silla lounge Bini / Mesa lounge Bini

Toledo & Toledo Aire

 indecasa
Collection

✎ Π

 Delta de Plata
Premio ADI 2018

Design
Jorge Pensi

« La colección Toledo y Toledo Aire nació con la silla Toledo, una de las sillas con más carisma e historia, galardonada con diversos premios. La Silla Toledo Aire es la evolución de la icónica silla de aluminio producida en una sola pieza de polipropileno inyectado. Las mesas realizadas en varias medidas y tableros armonizan y dan sentido a toda la colección. »

« Toledo and Toledo Aire Collection was born with one of the chairs with more charisma and history, awarded with various awards. Toledo Aire is the evolution of the iconic aluminium Toledo chair, and it is produced as a single piece of injected polypropylene. The tables are made in various sizes and tops harmonize and give a sense of the whole to the entire collection. »

« La chaise Toledo à inspirée notre collection Toledo et Toledo Aire. Celle-ci est des chaises les plus charismatique de l'histoire du mobilier, ainsi récompensée de nombreux prix. La chaise Toledo Aire est l'évolution de notre chaise en aluminium, et est produite en une unique pièce de polypropylène injecté. Les tables de la même collection de tailles et coloris différents, donnent un sens à l'ensemble de la collection.»



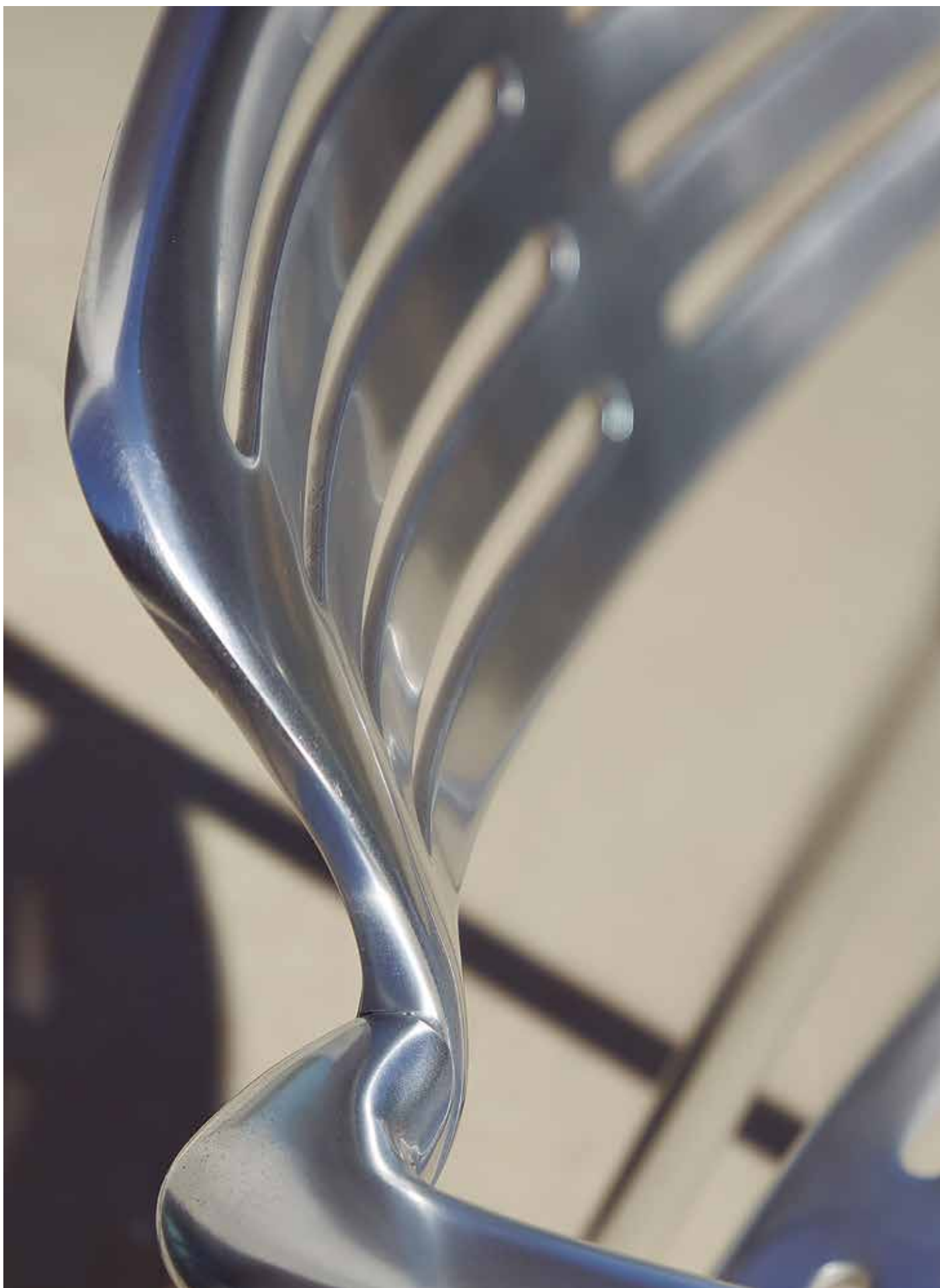

Silla Toledo



Silla Toledo / Mesa Pie Sputnik



Silla Toledo Aire Green Edition







Silla Toledo Aire







Mesa Toledo







Mesa Toledo Aire / Silla Toledo Aire

Woody

h A

Design
Josep Llusçà

« El diseño del sillón WOODY tiene un aroma sutilmente “vintage”, como homenaje a la clásica silla de listones de madera. Apuesta por el equilibrio entre conceptos esenciales como ligereza, funcionalidad, ergonomía y respeto al medio ambiente. »

« The design of the WOODY armchair has a subtly “vintage” vibe, a tribute to the classic wooden slatted chair. It encapsulates the balance between essential concepts such as lightness, functionality, ergonomics and care for the environment. »

« Le design du fauteuil WOODY a une touche subtilement “vintage”, en hommage à la classique chaise avec des barreaux de bois. Misant sur l'équilibre entre les concepts essentiels comme la légèreté, la fonctionnalité, l'ergonomie et le respect pour l'environnement. »





Silla Woody Green Edition



Silla Woody Green Edition



Silla Woody Tapizada

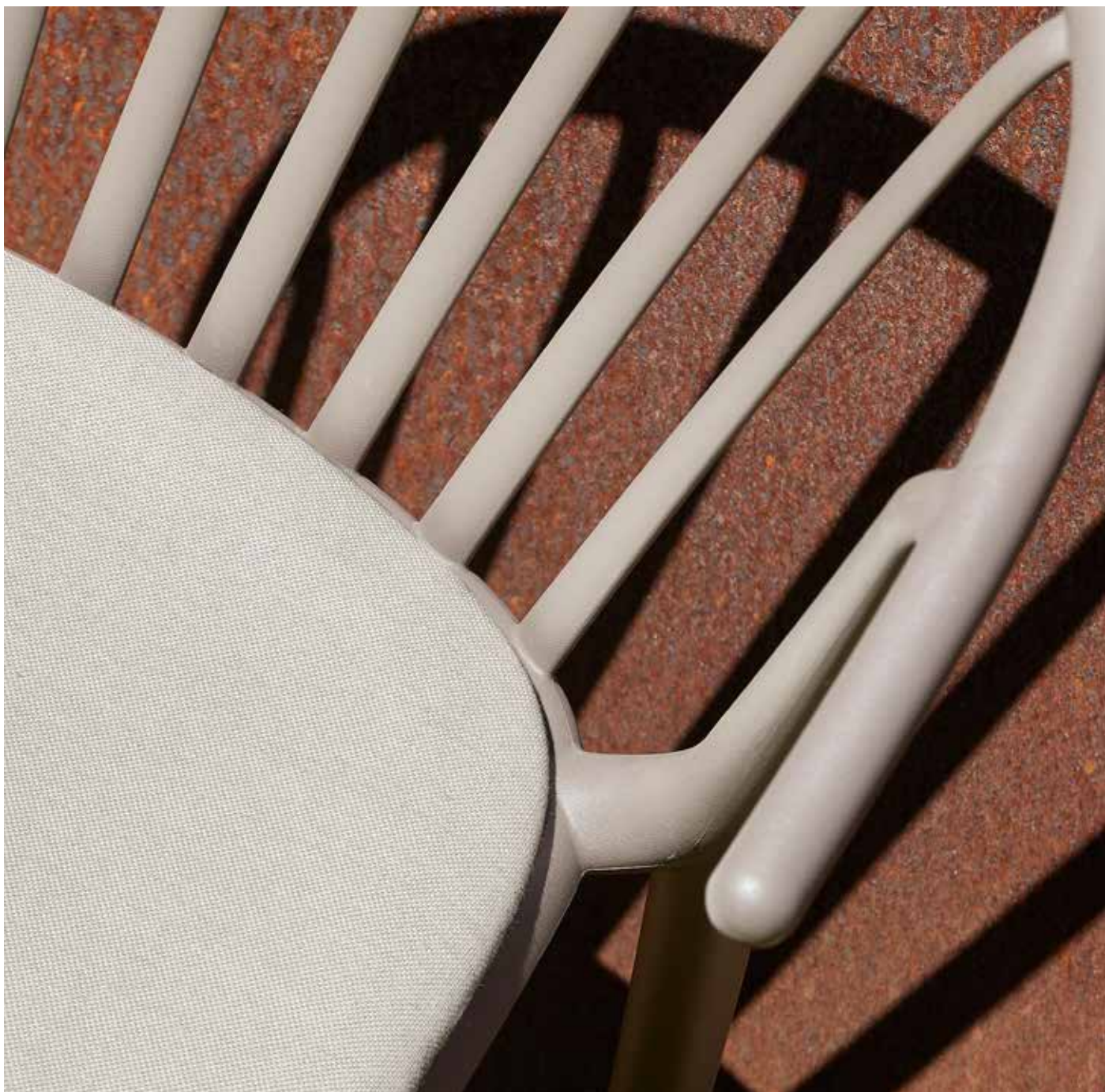



Taburete Woody

New



Steely



Design
Josep Llusçà

« Un sillón trabajado con curvas complejas y formas naturales. »

« An armchair produced with complex curves and natural forms. »

« Un fauteuil travaillé avec des courbes complexes et des formes naturelles. »



Silla Steely Green Edition



Silla Steely



Lisboa

h h h

Design
Joan Gaspar

« LISBOA busca la integración sin estridencias en los espacios, con elegancia, pero con contundencia formal. Su diseño recuerda a la silla de toda la vida, pero con una clara innovación en materiales y prestaciones. »

« LISBOA seeks integration without stridency, with elegance and formal solidity. Its design reminds us of a classic chair, but with clear innovation in materials and features. »

« LISBOA recherche l'intégration sans complications dans les espaces, avec élégance, mais avec une force formelle. Son design rappelle la chaise de toujours, mais avec une innovation claire en matériaux et prestations. »







Silla Lisboa / Silla con brazos Lisboa



Taburete Lisboa



Taburete Lisboa

Smart



Design Javier Cuñado

« Con la silla SMART, se trataba de generar un concepto simpático, con formas dinámicas que transmitieran movimiento y fluyeran con sensualidad, con un toque fresco y detalles muy cuidados. Su personalidad no va reñida con su funcionalidad. Es atractiva, ligera y sorprendentemente robusta, con una amplia propuesta de colores capaces de mimetizarse en entornos muy diversos. »

« With the SMART, it was about generating an amenable concept with dynamic shapes that would transmit movement and flow sensually, with a fresh touch and close attention to details. Its personality does not conflict with its functionality. It is attractive, light and surprisingly robust, with a wide range of colours, able to fit into very diverse environments. »

« Avec la chaise SMART, il s'agissait de générer un joli concept, avec des formes dynamiques qui transmettent le mouvement et le flux avec sensualité, avec une touche fraîche et des détails très soignés. Sa personnalité n'est pas en contradiction avec sa fonctionnalité. Ce modèle est attrayant, léger et étonnamment robuste, avec une large gamme de couleurs capables de se fondre dans des environnements très divers. »

New





Silla con brazos Smart



New

Smart

Como

h h

Design
Joan Gaspar

« COMO es una silla solvente, resistente y cómoda. Conseguida mediante un ejercicio de simplificación formal y conceptual, con guiños a estructuras y soluciones. »

« COMO is a sound, resilient and comfortable chair. Achieved through an exercise in formality and conceptual simplification, with references to frames and solutions. »

« COMO est une chaise sérieuse, résistante et confortable. Obtenue grâce à un exercice de simplification formel et conceptuel, avec des clins d'œil aux structures et aux solutions. »



New



Silla Como / Silla con brazos Como





New

Como

Sue



Design Joan Gaspar

« De líneas suaves y simples, la silla SUE recuerda a las sillas de madera de ataño, buscando la máxima estabilidad y confort con un toque retro. »

« With soft, simple lines, the SUE chair reminds us of the wooden chairs of yesteryear. Chair with a retro touch, boasting maximum stability and confort. »

« Avec des lignes douces et simples, la chaise SUE rappelle les chaises en bois d'autrefois, en recherchant le maximum de stabilité et de confort avec une touche rétro. »







Silla con brazos Sue

Ikona



Delta de Bronce
Premio ADI 2020



Good Design Award
2019/2020

Design Jorge Pensi

« La silla IKONA nace con el deseo de perdurar en el tiempo debido a sus claros signos de identidad y su presencia no invasiva. Su silueta orgánica abraza el cuerpo de la persona sentada. »

« The IKONA chair was born with the desire to endure over time due to its clear identity and its non-invasive presence. Its organic silhouette embraces the body of the seated person. »

« La chaise IKONA est née avec le désir de perdurer dans le temps en raison de ses signes clairs d'identité et sa présence non invasive. Sa silhouette organique embrasse le corps de la personne qui est assise. »





Silla Ikona



Silla Ikona

Tokyo

トキョ

Design
Josep Llusçà

« Una silla con un aroma oriental, donde podemos apreciar el equilibrio entre ligereza y funcionalidad. »

« A chair with an oriental vibe, striking just the right balance between lightness and functionality. »

« Une chaise avec une touche orientale, où nous pouvons apprécier l'équilibre entre la légèreté et la fonctionnalité. »



Silla Tokyo Green Edition



Silla Tokyo Green Edition



Silla Tokyo

Silla Tokyo Tapizada





Splash



Design
Jorge Pensi

« El sonido SPLASH nos recuerda a agua, terrazas, piscinas y verano. Una invitación a relajarse y descansar. »

« The SPLASH sound reminds us of water, terraces, swimming pools and summer. An invitation to rest and relax. »

« Le son SPLASH nous rappelle l'eau, les terrasses, les piscines et l'été. Une invitation à se détendre et se reposer. »



Silla con brazos Splash

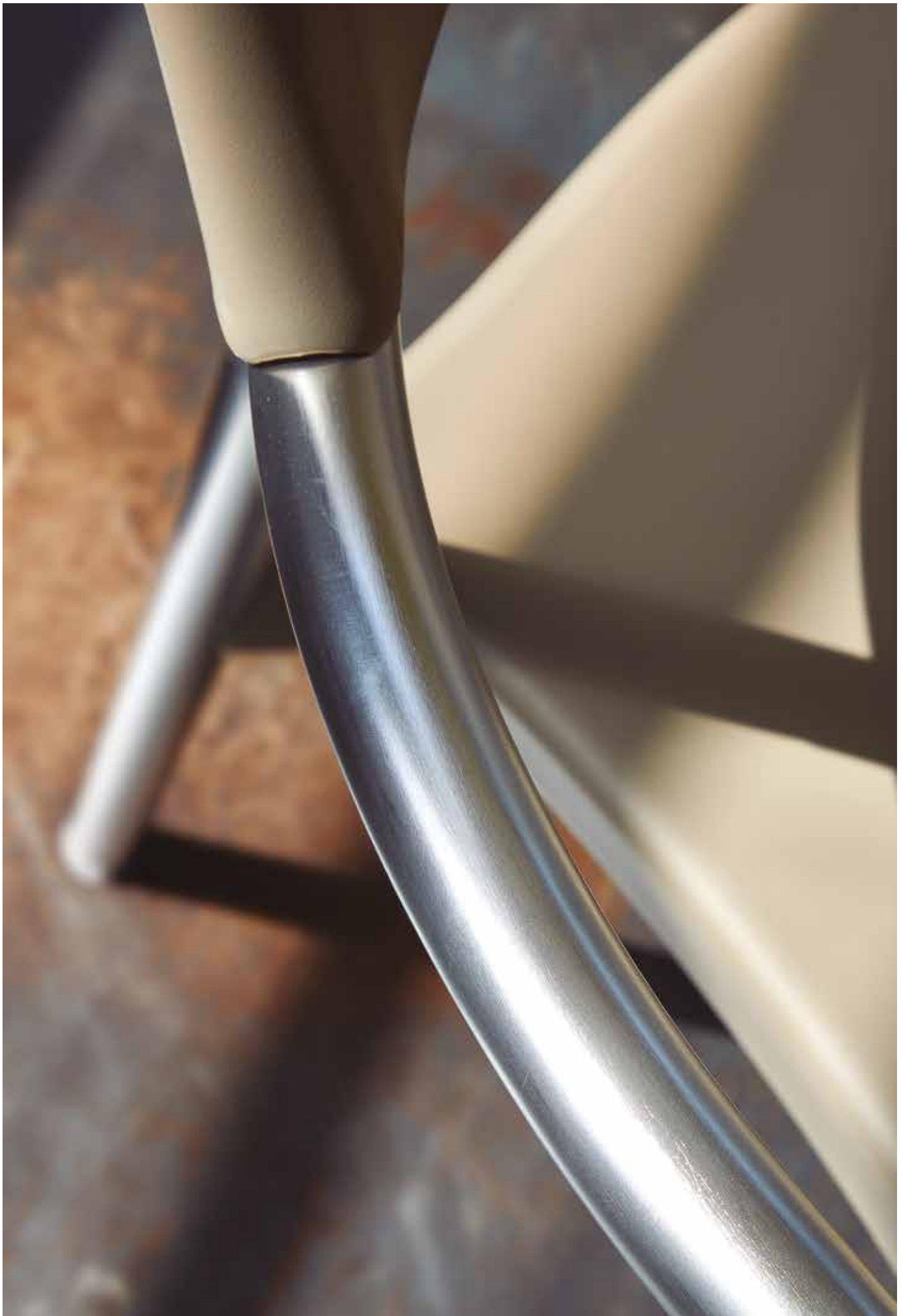

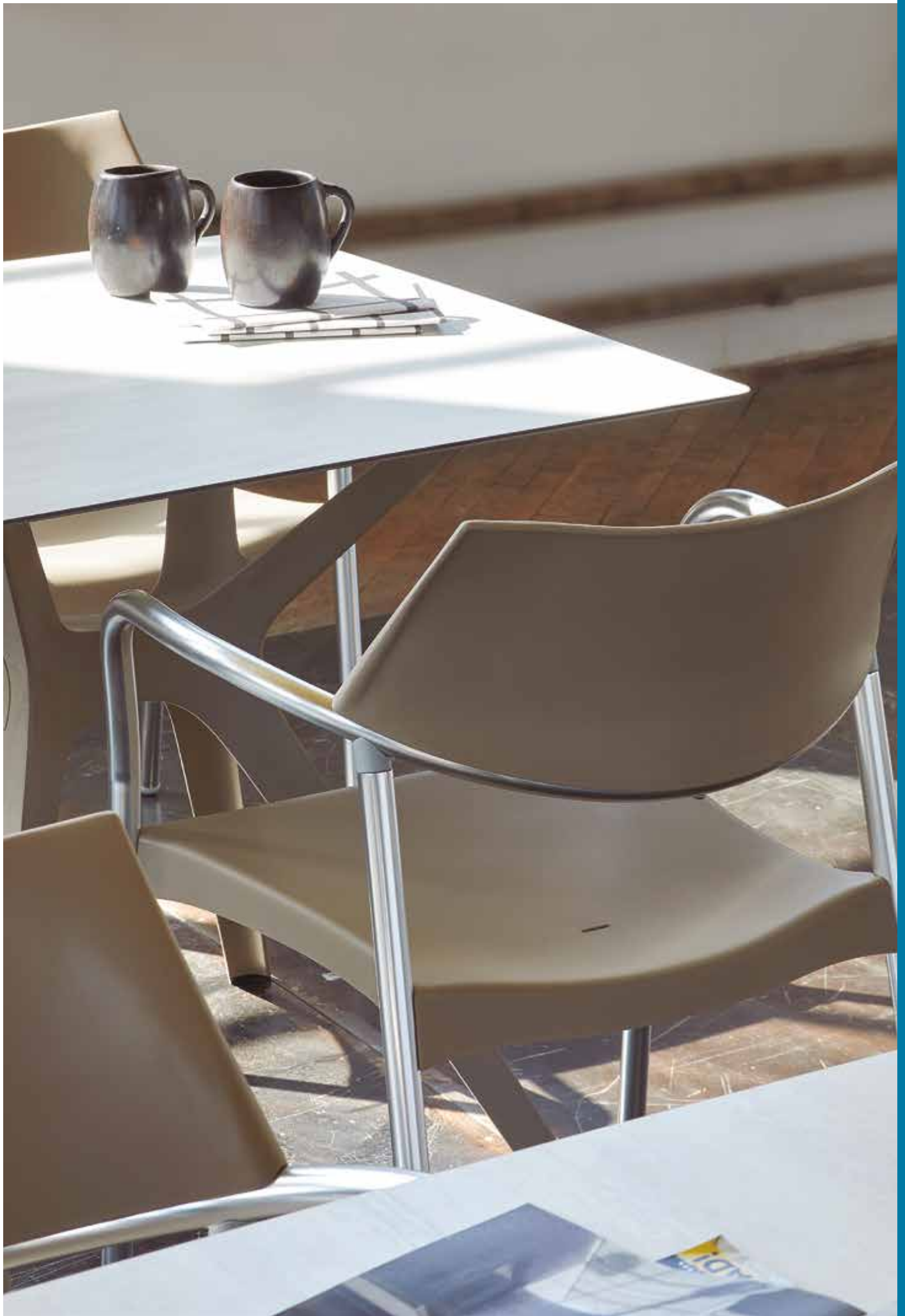

Splash Aire



Design
Jorge Pensi

« SPLASH AIRE, es una silla con brazos, cómoda y funcional, ideal para uso interior y exterior. Es la evolución de la silla SPLASH, adecuando la utilización de nuevas tecnologías que permiten obtener en una sola pieza la misma silla original, con el mismo y extraordinario confort. »

« SPLASH AIRE is a chair with arms, comfortable and practical, ideal for indoor and outdoor use. It has evolved from the SPLASH chair, adapting the use of new technologies that enable the same original chair to be obtained in one piece, with the same extraordinary comfort. »

« SPLASH AIRE, est une chaise avec accoudoirs, confortable et fonctionnelle, idéale pour une utilisation en intérieur et extérieur. C'est l'évolution de la chaise SPLASH, adaptant l'utilisation des nouvelles technologies qui permettent d'obtenir en une seule pièce la même chaise originale, avec le même confort extraordinaire. »







Casino



Design
Joan Gaspar

« CASINO busca la eficacia. Transmite silencio y contención, y consigue una confortabilidad extrema. »

« CASINO seeks efficiency. It transmits silence and containment while achieving extreme comfort. »

« CASINO recherche l'efficacité. Elle transmet une sensation de silence et contention et apporte un confort extrême. »







Silla Casino / Mesa Corner 4 Patas

Fiona & New Fiona



Design
Josep Llusçà

« FIONA es una silla ideal para cualquier espacio del hogar. »

« FIONA is an ideal chair for any home space. »

« FIONA est une chaise idéale pour n'importe quel espace de la maison. »





Silla con brazos New Fiona



Silla con brazos New Fiona Tapizada







Lama



Design
Josep Llusçà

« LAMA es una silla funcional y sólida con sus formas rectilíneas. Disponible con o sin brazos, la hacen la silla perfecta para interior y exterior gracias a su diseño neutro. »

« LAMA's rectilinear forms make it a practical and solid chair. Available with or without arms, its neutral design makes it the perfect chair for indoors and outdoors. »

« LAMA est une chaise fonctionnelle et solide avec ses formes rectilignes. Disponible avec ou sans accoudoirs, elle est la chaise idéale en intérieur et extérieur grâce à son design neutre. »





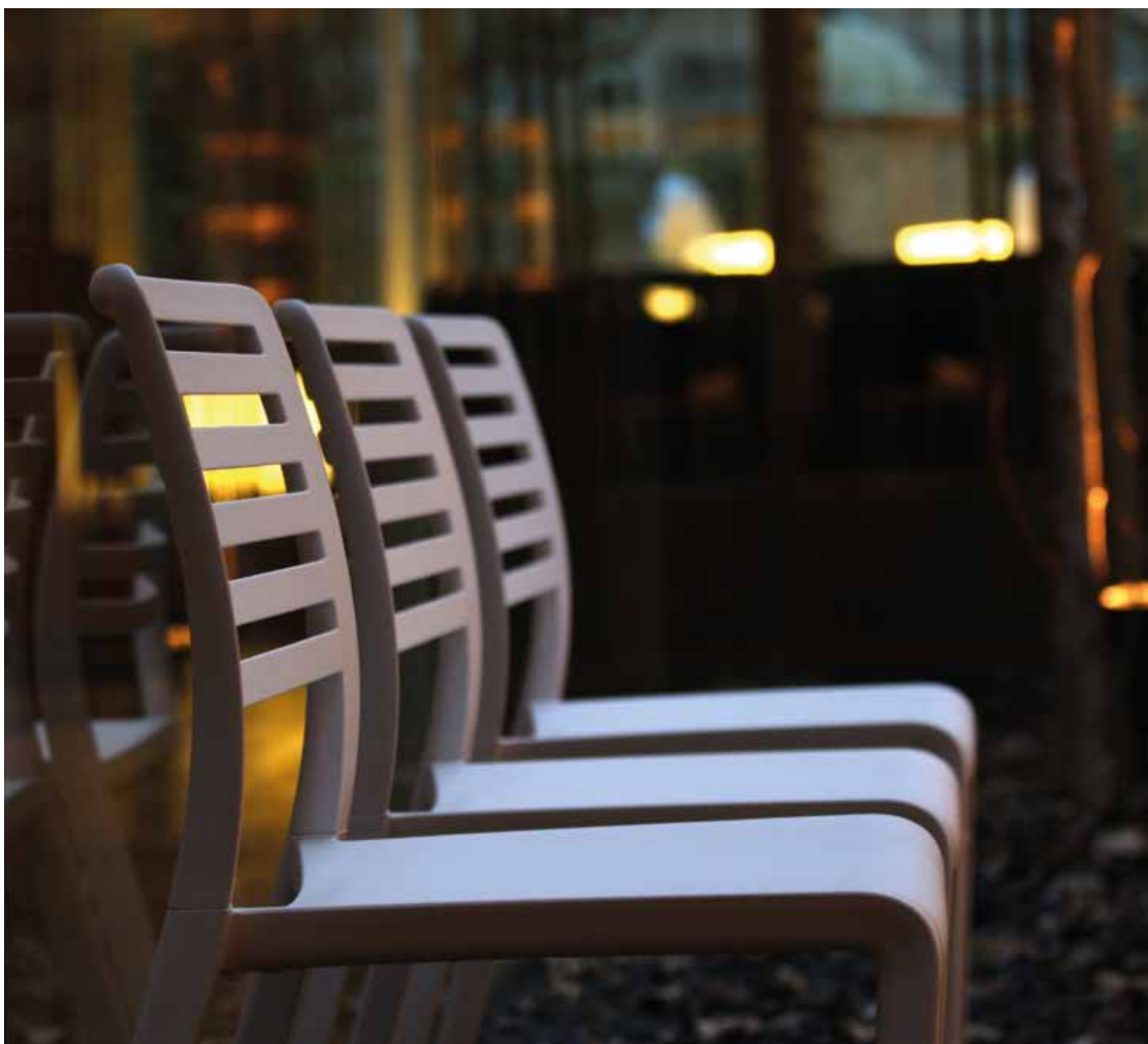

Silla Lama

Trama



IIDA Winner IIDA/HD
Product 2011

Design
Josep Llusçà

« El respaldo de una silla es la parte que más se percibe en un espacio. TRAMA está dotada de una transparencia óptica que le quita peso tanto física como visualmente creando un ambiente singular en un espacio con gran número de sillas. Al mismo tiempo estas perforaciones en el respaldo lo hacen transpirable. »

« The back of a chair is the part that is most perceived in a space. TRAMA is endowed with an optical transparency that removes weight both physically and visually, creating a unique atmosphere in a space with a large number of chairs. At the same time, these perforations in the backrest make it breathable. »

« Le dossier d'une chaise est la partie que l'on voit le plus dans un espace. TRAMA est dotée d'une transparence optique qui la rend plus légère aussi bien physiquement que visuellement, créant une ambiance particulière dans un espace avec un grand nombre de chaises. En même temps, ces perforations dans le dossier la rendent transpirable. »







Silla Trama

Beekat & Netkat



Platinum Award
MIFF 2013

IIDA

Excellence IIDA/HD
Product Design 2012

Design
Josep Llusçà

« La KAT COLLECTION transmette una imatge de modernitat, confort i durabilitat. »

« The KAT COLLECTION transmit an image of modernity, comfort and durability. »

« La KAT COLLECTION transmet une image de modernité, confort et durabilité. »



Silla Beekat / Silla con brazos Beekat









Silla Netkat / Silla con brazos Netkat

Gina



Design
Joan Gaspar

« Ligera y apilable, de aspecto romántico. GINA busca un diálogo silencioso con el usuario, pero al mismo tiempo contundente y con una integración sin estridencias con su entorno, como también una primera sensación de familiaridad con el objeto. »

« Light and stackable, romantic-looking. GINA seeks a silent, strong dialogue with its user and a smooth integration with its surroundings, as well as a first sense of familiarity with the object. »

« Légère et empilable, d'aspect romantique. GINA recherche un dialogue silencieux et ferme à la fois avec l'utilisateur et une intégration sans complications dans l'environnement, ainsi qu'une première sensation de familiarité avec l'objet. »







Silla Gina / Silla con brazos Gina

Peach



IIDA Winner IIDA/HD
Product 2011

Design
Joan Gaspar

« PEACH está marcada por un diseño amable, cercano y funcional, alejado siempre de aportaciones superfluas. »

« PEACH is marked by a friendly, warm and functional design, far from superfluous contributions. »

« PEACH est marquée par un design aimable, proche et fonctionnel, toujours loin d'apports superflus. »



Silla con brazos Peach





Silla con brazos Peach

Carla

h

Design
Fabrizio Batoni

« Destacada por su estilo apasionado y su modernidad. »

« Featured for its passionate style and modernity. »

« Elle se distingue pour son style passionné et sa modernité. »







Silla Carla

Spot

h

Design
Josep Llusçà

« SPOT se convierte en una alternativa ideal para cualquier espacio interior y exterior, concebida especialmente para resolver espacios reducidos. »

« SPOT becomes an ideal alternative for any interior and exterior space, specially designed for small spaces. »

« SPOT est devenu une alternative idéale pour n'importe quel espace intérieur et extérieur, conçu tout particulièrement pour résoudre des espaces réduits. »







Silla Spot Green Edition

Neutra

h

Design
Joan Gaspar

« Amable y silenciosa, sin pretender llamar la atención. »

« Kind and silent, it's not desperate to grab your attention. »

« Aimable et silencieuse, sans prétendre attirer l'attention. »

1.1







Silla Neutra

Vela

TT

IIDA Excellence IIDA/HD
Product Design 2014



Design Fabrizio Batoni

« Se adapta a cada ambiente, satisfaciendo también el diseño y la necesidad de elegancia. »

« It adapts to each environment, with elegance and a satisfying design. »

« Elle s'adapte à chaque ambiance, répondant également en matière de design et besoin d'élégance. »







Mesa Vela / Silla Carla

Barcino Collection

TT A

Design
Joan Gaspar

« BARCINO COLLECTION se caracteriza por ser un conjunto de productos sólidos y contundentes, formalmente ligeros y sumamente funcionales. »

« BARCINO COLLECTION, it is characterized by being a set of solid and forceful products, formally light, beautiful and highly functional. »

« BARCINO COLLECTION, il se caractérise par être un ensemble de produits solides et puissants, formellement légers, beaux et très fonctionnels. »









Mesa Barcino Pie Central



Mesa Barcino 4 Patas









Taburete Barcino / Mesa Barcino

Noren

π

Design

David Carrasco Barceló

« Mesa de elegante diseño, adaptable según la combinación de sobres y perfecta para ubicar en el salón o en un despacho privado. »

« An elegantly designed table, adaptable according to the combination of envelopes and perfect for installing in a living room or private office. »

« Table au design élégant, adaptable selon la combinaison de plateaux et parfaite à placer dans le salon ou dans un bureau privé. »







Mesa Noren / Silla Skin

Corner

π

Design Resol

« CORNER es una mesa original que permite combinar su estructura y los distintos acabados de sobre, según las formas y medidas que desee. »

« CORNER is an original table that lets you combine its frame and the various top finishes according to the shapes and measurements you wish. »

« CORNER est une table originale qui permet de combiner sa structure et les différentes finitions du plateau, selon les formes et les dimensions que vous souhaitez. »





Mesa Corner 4 Patas / Silla Casino



Mesa Corner 3 Patas

New Flash

π

Design
Josep Llusçà

« Sus formas redondeadas la amabilizan, la textura de las distintas partes y la gama cromática en que se realiza, le confieren un aspecto sobrio e informal al mismo tiempo que permite un doble uso, interior y exterior. »

« Its rounded shapes offer comfort, and the texture colour range of the different parts give it a sober, informal look while allowing it to be used for both interior and exterior spaces. »

« Ses formes arrondies la rendent aimable, la texture des différentes parties et la gamme chromatique de sa fabrication lui confèrent un aspect sobre et informel tout en permettant un double usage, intérieur et extérieur. »



Wood New Flash

TT

Design
Josep Llusçà

« WOOD NEW FLASH se caracteriza por sus elegantes patas de madera que le confieren una elegancia única, siendo perfecta en cualquier espacio interior. »

« WOOD NEW FLASH features smart wooden legs that give it a unique elegance that makes it perfect for any indoor setting. »

« WOOD NEW FLASH se caractérise par ses élégants pieds en bois qui lui confèrent une élégance unique, étant parfaite pour n'importe quel espace intérieur. »



New Dessa

π

Design
Josep Lluscà

« NEW DESSA es una práctica y versátil mesa, con diseño funcional y gran durabilidad. Líneas elegantes y colores sobrios, es ideal para reuniones familiares. »

« NEW DESSA is a practical and versatile table, with a functional design and great durability. Its elegant lines and restrained colours make it ideal for family get-togethers. »

« NEW DESSA est une table pratique et polyvalente, avec un design fonctionnel et une grande durabilité. Lignes élégantes et couleurs sobres, elle est idéale pour les réunions de famille. »





Mesa New Dessa / Silla Trama



Mesa New Dessa / Silla Trama

Noa

π

Design David Carrasco Barceló

« La mesa NOA se inspira en las tradicionales mesas realizadas en metal y cerámica para crear la separación entre la parte superior y la estructura, pero adoptando unas formas simples y suaves. Es ideal para cualquier estancia. »

« The NOA table is inspired by traditional tables made using metal and ceramics to create the separation between the top and the frame, while adopting simple, smooth shapes. It's ideal for any room. »

« La table NOA s'inspire des tables traditionnelles en métal et en céramique pour créer la séparation entre le plateau et la structure, mais en adoptant des formes simples et lisses. Elle est idéale pour n'importe quelle pièce. »







Paris

 indecasa
Collection

TT

Design
Jorge Pensi

« Inconfundible pieza de las terrazas más prestigiosas de París, la mesa del mismo nombre destaca por su robustez y sus líneas sobrias. De una durabilidad singular, la hacen indispensable para crear estancias exteriores del más alto nivel. »

« Distinctive piece of the most prestigious terraces in Paris, the table with the same name stands out by its robustness and its essential and elegant lines indispensable to create outdoor spaces at the highest level. »

« Pièce incontournable des terrasses les plus prestigieuses de Paris, la table du même nom se distingue par sa robustesse et ses lignes sobres. D'une durabilité singulière, la rendant indispensable pour créer des espaces extérieurs du plus haut niveau. »







Mesa Inox Pie Paris

Sputnik

π

Design
Josep LLuscà

« SPUTNIK se convierte en un elemento versátil y atractivo gracias a su original diseño y a la variedad de colores que se ofrece en todas las piezas que la conforman. »

« SPUTNIK becomes a versatile and attractive element thanks to its original design and the variety of colours that it is offered in all the pieces that make it up. »

« SPUTNIK est fait un élément polyvalent et attractif grâce à son design original et la variété des couleurs proposée dans toutes les pièces la composant. »





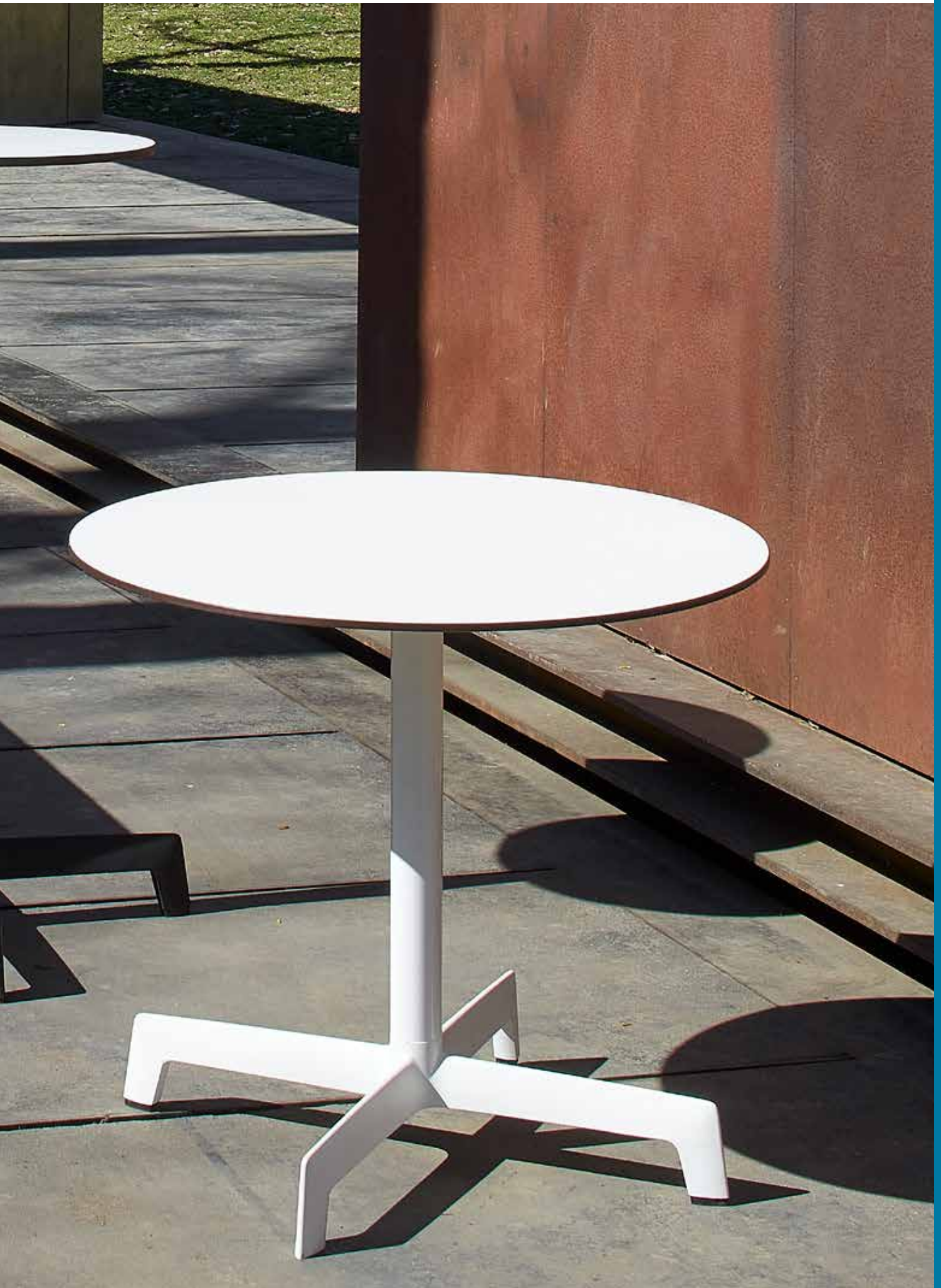

Fall

π

Design
Resol

« El pie de centro FALL es funcional y práctico gracias a su diseño apilable. »

« The stackable design of the FALL centre stand makes it functional and practical. »

« Le pied central FALL est fonctionnel et pratique grâce à son design empilable. »



Drop

π

Design Resol

« Estructura de pie central DROP, con sistema abatible y apta para interior y exterior. Perfecta para todo tipo de ambientes según la combinación de los sobres de mesa. »

« The DROP central foot structure, with a folding system, is suitable for indoor and outdoor use and perfect for all types of settings, depending on the combination of tabletops. »

« Structure de pied central DROP, avec un système rabattable et adapté à l'intérieur et à l'extérieur. Parfait pour tous types de cadres en fonction de la combinaison des plateaux de table. »



Set Raff



Design Joan Gaspar

« La nueva silla RAFF representa un claro ejemplo de fusión entre forma y función. Modelo elegante que, a pesar de su toque de clasicismo, no renuncia a la máxima modernidad de la propuesta. »

« The new RAFF chair represents a clear example of the fusión between form and function. An elegant model, which despite its classicism does not give up the idea of modernity. »

« La nouvelle chaise RAFF est un exemple clair de fusion entre la forme et la fonction. Modèle élégant, qui malgré une touche de classicisme ne renonce pas à la modernité maximale de la proposition. »







Click-Clack



Platinum Award
MIFF 2014

Design Josep Lluscà

« CLICK-CLACK ha sido diseñado buscando líneas depuradas, de aspecto clásico, sobrio y atemporal, dando mayor importancia a las proporciones frente al exceso de detalles. »

« CLICK-CLACK has been designed by seeking out refined lines, with a classic, sober and timeless appearance, giving greater importance to the proportions rather than excessive details. »

« CLICK-CLACK a été conçu en cherchant des lignes épurées, d'aspect classique, sobre et intemporel, donnant plus d'importance aux proportions par rapport à l'excès des détails. »



Sofá Click-Clack/ Mesa Click-Clack





Set Click-Clack

Sky Club & Sky Premium



Design
Josep Llusçà

« El *sunlounger* SKY ofrece un sutil equilibrio entre ligereza, ergonomía y transparencia. »

« The SKY sunlounger offers a subtle balance between lightness, ergonomics and transparency. »

« La chaise longue pour bain de soleil SKY offre un équilibre subtil entre légèreté, ergonomie et transparence. »





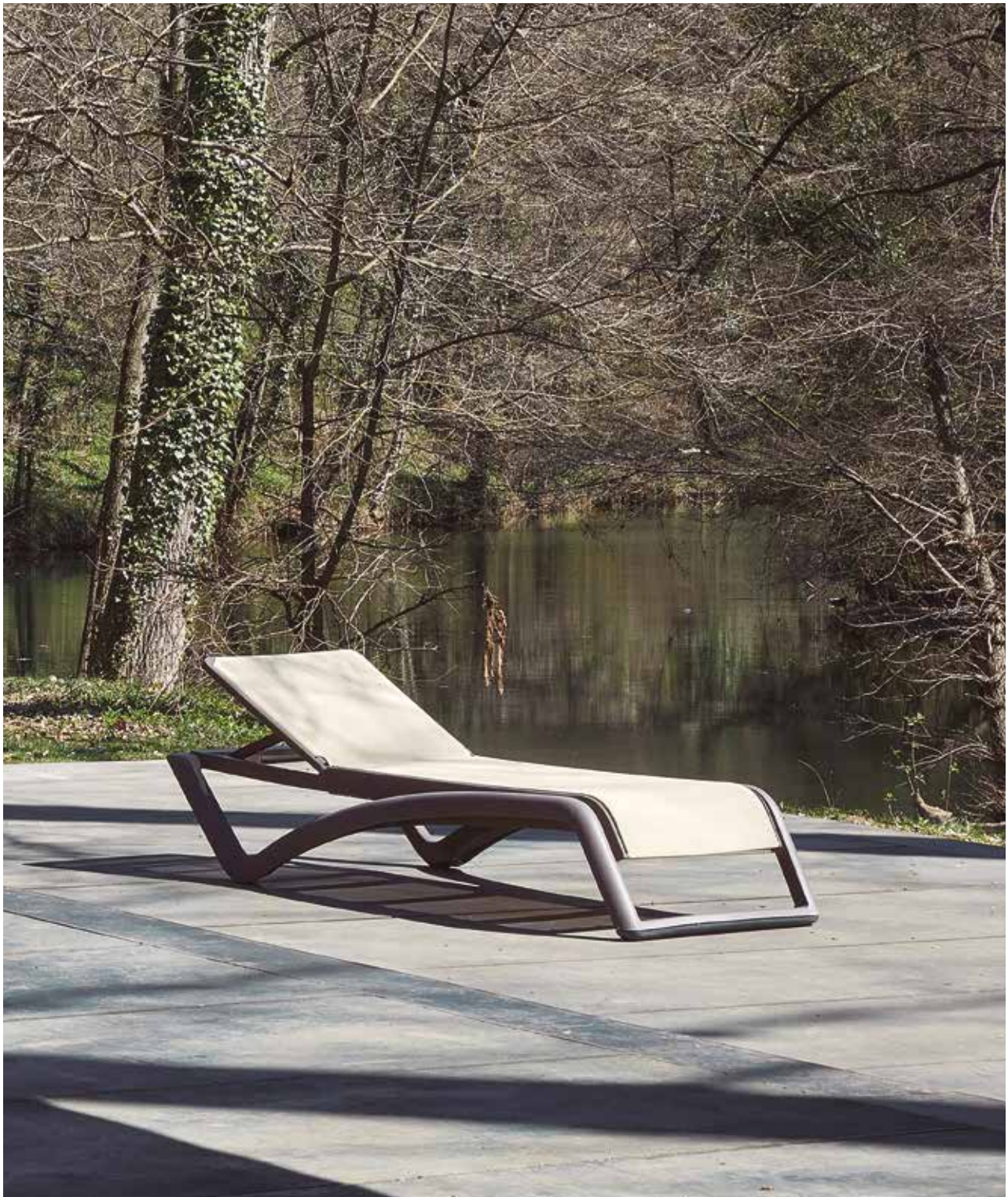

Tumbona Sky

Marina Club



« Disponible en una amplia gama de colores, permite adaptarse según el entorno. Su diseño se caracteriza por su ligereza y alta resistencia. »

« Available in a wide range of colours, it can be adapted to any setting. Its design features lightness and high resilience. »

« Disponible dans une large gamme de couleurs, elle peut s'adapter à l'environnement. Son design se caractérise par sa légèreté et sa haute résistance. »







Marina Beach



« Ideal para disfrutar de los momentos de tranquilidad. MARINA BEACH incorpora una caja de seguridad en el chasis para guardar objetos de forma segura. No tendrás que preocuparte de nada más que de disfrutar. »

« Ideal for enjoying quiet moments. MARINA BEACH has a built-in safe in its frame for storing objects safely, so you won't have to worry about anything other than having a good time. »

« Idéale pour profiter de moments de calme. MARINA BEACH contient un coffre-fort dans le châssis pour ranger les objets en toute sécurité. Vous n'aurez à vous soucier de rien d'autre que d'en profiter. »



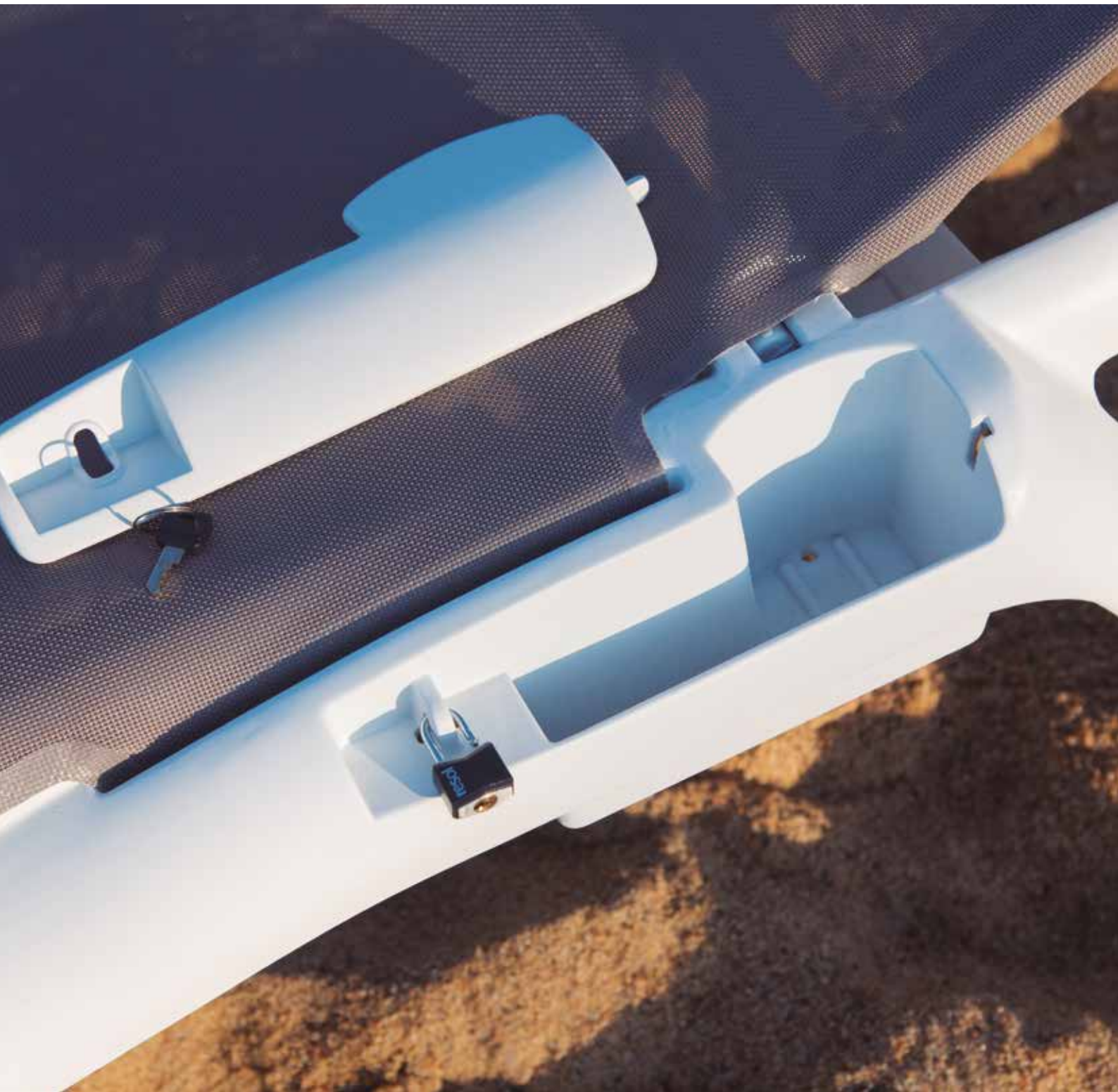

Tumbona Marina Beach





 Resol

Especificaciones Técnicas
Technical Data
Spécifications Techniques



Sillas

Chairs / Chaises



Anthea

Designed by Monica Armani



Asiento individual con estructura de aluminio lacado, cojines y tapizados idóneos para el exterior. Respaldo en cinta de pasamanería trenzada sobre tubo de aluminio. Amplia gama cromática y combinaciones. Apto para exterior.

Individual seat with a lacquered aluminium structure, with cushions and upholstery suitable for the outdoors and braided ribbon backing on aluminium tubing. Wide colour range and combinations to choose between optional cushions. Suitable for outdoors.

Assise individuelle avec structure en aluminium laqué, coussins et tapissés parfaits pour l'extérieur, et dossier en ruban de passementerie tressée sur des tubes en aluminium. Vaste gamme de couleur et combinaisons à choisir parmi les couleurs en option. Utilisable à l'extérieur.

Medidas | Measures | Mesures

W 60cm x L 53cm x H 76cm x Hs 48cm x Ha 71cm
W 23,62in x L 20,87in x H 29,92in x Hs 18,9in x Ha 27,95in

Peso | Weight | Poids

9,5 kg

Logística | Logistics | Logistique

	20'	40'	40' HC	70 m ³	100 m ³
1X	75	165	195	-	195



Ver combinaciones de colores en página 447.
See color combinations on page 447.

Espiga

Designed by Jordi Ribaudí



Silla con estructura patín de acero pintado. Cinta de polyester ignífuga e hidrófuga. Tacos antideslizantes. Tornillería de acero inoxidable.

Chair with a painted steel sled-base structure. Flame-retardant and water-repellent polyester strip. Anti-slip feet. Screws made of stainless steel.

Chaise avec structure patin en acier peint. Bande de polyester ignifuge et hydrofuge. Embouts antidérapants. Visserie en acier inoxydable.

Medidas | Measures | Mesures

W 54,6cm x L 57cm x H 81cm x Hs 48,6cm
W 21,5in x L 22,44in x H 31,89in x Hs 19,13in

Peso | Weight | Poids

6,16 kg

Apilado | Stackable | Empilable

2 unidades | units | unités

Logística | Logistics | Logistique

	20'	40'	40' HC	70 m ³	100 m ³
4X	332	664	731	797	0



Espiga armchair

Designed by Jordi Ribaudí



Silla con brazos con estructura patín de acero pintado. Cinta de polyester ignífuga e hidrófuga. Tacos antideslizantes. Tornillería de acero inoxidable.

Chair with armrests with a painted steel sled-base structure. Flame-retardant and water-repellent polyester strip. Anti-slip feet. Screws made of stainless steel.

Chaise à bras avec structure patin en acier peint. Bande de polyester ignifuge et hydrofuge. Embouts antidérapants. Visserie en acier inoxydable.

Medidas | Measures | Mesures

W 59,2cm x L 57,9cm x H 81cm x Hs 48,6cm x Ha 66,4cm
W 23,31in x L 22,8in x H 31,89in x Hs 19,13in x Ha 26,14in

Peso | Weight | Poids

8,08 kg

Apilado | Stackable | Empilable

2 unidades | units | unités

Logística | Logistics | Logistique

	20'	40'	40' HC	70 m ³	100 m ³
2X	83	166	183	199	-



Silla Espiga lounge

Designed by Jordi Ribaudí



Sillón bajo con estructura patín en acero pintado. Cinta de polyester ignífuga e hidrófuga. Tacos antideslizantes. Tornillería de acero inoxidable.

Lounge chair with painted steel sled base. Waterproof and fire-retardant Polyester bands. Non-slip glides and stainless steel hardware.

Fauteuil bas avec patin structure en acier peint. Bande de polyester ignifuge et hydrofuge. Embouts antidérapants. Visserie en acier inoxydable.

Medidas | Measures | Measures

W 68,8cm x L 66,7cm x H 75,4cm x Hs 43,1cm
W 27,09in x L 26,26in x H 29,69in x Hs 16,97in

Peso | Weight | Poids

7,52 kg

Logística | Logistics | Logistique

	20'	40'	40 HC	70 m ³	100 m ³
	2X	240	481	0	577



Milano

Designed by Joan Gaspar



Silla apilable para uso interior y exterior. Estructura de aluminio anodizado pintado por pulverización secado al horno.

Stackable armchair for indoor and outdoor use. Powder coated anodized aluminium structure.

Fauteuil empilable pour une utilisation à l'intérieur et à l'extérieur. Structure en aluminium anodisé peinte au pistolet et séchée au four.

Medidas | Measures | Measures

W 49cm x L 54cm x H 80cm x Hs 43cm
W 19,29in x L 21,26in x H 31,5in x Hs 16,93in

Peso | Weight | Poids

8 kg

Logística | Logistics | Logistique

	20'	40'	40 HC	70 m ³	100 m ³
	1X	248	528	-	-



Cojines incluidos
Cushions included
Coussins inclus

Milano armchair

Designed by Joan Gaspar



Sillón apilable para uso interior y exterior. Estructura de aluminio anodizado pintado por pulverización secado al horno.

Stackable armchair for indoor and outdoor use. Powder coated anodized aluminium structure.

Chaise empilable avec accoudoirs pour une utilisation à l'intérieur et à l'extérieur. Structure en aluminium anodisé peinte au pistolet et séchée au four.

Medidas | Measures | Measures

W 57cm x L 54cm x H 80cm x Hs 43cm x Ha 62cm
W 22,44in x L 21,2in x H 31,5in x Hs 16,93in x Ha 24,41in

Peso | Weight | Poids

9 kg

Logística | Logistics | Logistique

	20'	40'	40 HC	70 m ³	100 m ³
	1X	248	528	-	-



Cojines incluidos
Cushions included
Coussins inclus

Lucca 02

Designed by Joan Casas



Sillón con perfil exclusivo de aluminio anodizado. Escuadras de unión y travesaño de fundición de aluminio. Textilene Batyline ignífugo. Tornillería de acero inoxidable. Tacos antideslizantes.

Armchair with exclusive anodized aluminium profile. Joining brackets and crossbar made of cast aluminium. Flame-retardant Textilene Batyline. Screws made of stainless steel. Anti-slip feet.

Fauteuil au profil exclusif en aluminium anodisé. Équerres d'union et traverses en fonte d'aluminium. Textilène Batyline ignifuge. Visserie en acier inoxydable. Embouts antidérapants.

Medidas | Measures | Mesures

W 62,5cm x L 65cm x H 94cm x Hs 47cm x Ha 67cm
W 24,61in x L 25,59in x H 37,01in x Hs 18,5in x Ha 26,38in

Peso | Weight | Poids Apilado | Stackable | Empilable

5,72 kg 2 unidades | units | unités

Logística | Logistics | Logistique

2X	107	213	235	256	-



Siena

Designed by Joan Casas



Silla de perfiles exclusivos de aluminio anodizado. Escuadras de unión y travesaño de fundición de aluminio. Tornillería de acero inoxidable. Textilene Batyline ignífugo. Tacos antideslizantes.

Chair with exclusive anodized aluminium profiles. Joining brackets and crossbar made of cast aluminium. Screws made of stainless steel. Flame-retardant Textilene Batyline. Anti-slip feet.

Chaise aux profils exclusifs en aluminium anodisé. Équerres d'union et traverse en fonte d'aluminium. Visserie en acier inoxydable. Textilène Batyline ignifuge. Embouts antidérapants.

Medidas | Measures | Mesures

W 47,8cm x L 57,4cm x H 85cm x Hs 47cm
W 18,82in x L 22,6in x H 33,46in x Hs 18,5in

Peso | Weight | Poids Apilado | Stackable | Empilable

3,86 kg 4 unidades | units | unités

Logística | Logistics | Logistique

4X	222	444	489	533	-

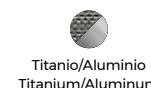

Siena armchair

Designed by Joan Casas



Silla con brazos de perfiles exclusivos de aluminio anodizado. Brazos, escuadras y travesaño de fundición de aluminio. Tornillería de acero inoxidable. Textilene Batyline ignífugo. Tacos antideslizantes.

Chair with armrests, with exclusive anodized aluminium profiles. Armrests, brackets and crossbar made of cast aluminium. Screws made of stainless steel. Flame-retardant Textilene Batyline. Anti-slip feet.

Chaise à bras aux profils exclusifs en aluminium anodisé. Bras, équerres et traverse en fonte d'aluminium. Visserie en acier inoxydable. Textilène Batyline ignifuge. Embouts antidérapants.

Medidas | Measures | Mesures

W 47,8cm x L 57,4cm x H 85cm x Hs 47cm x Ha 65,3cm
W 18,82in x L 22,6in x H 33,46in x Hs 18,5in x Ha 25,71in

Peso | Weight | Poids Apilado | Stackable | Empilable

4,82 kg 2 unidades | units | unités

Logística | Logistics | Logistique

2X	34	68	75	82	-

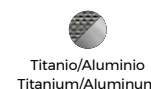

Sillas | Chairs | Chaises
SHAPE COLLECTION

Shape 4 Patas

Designed by Josep Llusçà



Sillón para uso interior. Carcasa inyectada en polipropileno con fibra de vidrio. Estructura de las patas en acero pintado. Carcasa y estructura del mismo color.

Armchair for indoor use. Seat injected in polypropylene and fiberglass. Structure made of painted steel. Seat and structure of the same colour.

Fauteuil pour usage intérieur. Siège injectée en polopropylène avec fibre de verre. Structure en acier peint. Siège et structure de même couleur.

Medidas | Measures | Measures

W 55,8cm x L 54,5cm x H 78,7cm x Hs 45cm x Ha 66,2cm
W 21,97in x L 21,46in x H 30,98in x Hs 17,72in x Ha 26,06in

Peso | Weight | Poids

6,35 kg

Logística | Logistics | Logistique

	20'	40'	40 HC	70 m ³	100 m ³
2X	216	480	600	960	-



Certificaciones | Certifications

NFEN581-1,NFEN581-2

Shape Patin

Designed by Josep Llusçà



Sillón para uso interior. Carcasa inyectada en polipropileno con fibra de vidrio. Estructura de las patas en acero pintado. Carcasa y estructura del mismo color.

Small armchair for indoor use. Polypropylene injected frame with fiberglass. Leg structure in painted steel. Body and structure in the same colour.

Petit fauteuil pour usage intérieur. Siège injecté en polypropylène et fibre de verre. Structure des pieds en acier peint. Siège et structure de la même couleur.

Medidas | Measures | Measures

W 58,5cm x L 55,5cm x H 77cm x Hs 45cm x Ha 66cm
W 23,03in x L 21,85in x H 30,31in x Hs 17,72in x Ha 25,98in

Peso | Weight | Poids

7,5 kg

Logística | Logistics | Logistique

	20'	40'	40 HC	70 m ³	100 m ³
2X	216	688	600	864	-



Certificaciones | Certifications

UNEEN581-CONTRACT,UNEN16139

Shape Click

Designed by Josep Llusçà



Sillón para uso interior y exterior. Carcasa y estructura inyectada en polipropileno con fibra de vidrio.

Armchair for indoor and outdoor use. Seat and structure injected in polypropylene and fiberglass. Clipping system that allows to combine the structure with the seat of Shape models.

Fauteuil pour usage intérieur et extérieur. Siège et structure injectée en polopropylène avec fibre de verre. Système de clipsage qui permet de combiner la structure avec les siège des modèles Shape.

Medidas | Measures | Measures

W 58,5cm x L 55cm x H 78,2cm x Hs 45,5cm x Ha 66,8cm
W 23,03in x L 21,65in x H 30,79in x Hs 17,91in x Ha 26,3in

Peso | Weight | Poids

6,18 kg

Logística | Logistics | Logistique

	20'	40'	40 HC	70 m ³	100 m ³
2X	216	342	342	532	-

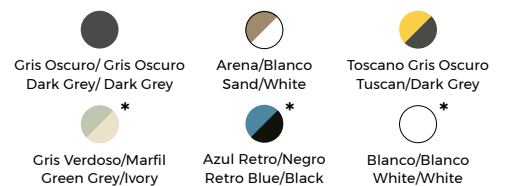

Certificaciones | Certifications

UNEEN581-1,UNEN16139

resoles

Shape Madera

Designed by Josep Llusçà



Sillón para uso interior. Carcasa asiento y base de patas inyectadas en polipropileno con fibra de vidrio. Patas de madera. Sistema de montaje mediante clipaje. Protección UV.

Armchair for indoor use. Seat frame and leg structure injected with polypropylene with fiberglass. Wooden legs. Clip-on assembly system. UV protection.

Fauteuil pour usage intérieur. Siège et base des pieds injectés en polypropylène et fibre de verre. Pieds en bois. Système de montage par clippage. Protection UV.

Medidas | Measures | Mesures

W 58,5cm x L 55cm x H 78,2cm x Hs 45,5cm x Ha 66,8cm
W 23,03in x L 21,65in x H 30,79in x Hs 17,91in x Ha 26,3in

Peso | Weight | Poids

5,48 kg

Logística | Logistics | Logistique

2X	216	480	600	960	-



Shape Araña

Designed by Josep Llusçà



Sillón para uso interior. Carcasa inyectada en polipropileno con fibra de vidrio. Estructura de las patas en acero pintado. Carcasa y estructura del mismo color.

Armchair for indoor use. Seat injected in polypropylene and fiberglass. Structure made of painted steel. Seat and structure of the same colour.

Fauteuil pour usage intérieur. Siège injectée en polypopylène avec fibre de verre. Structure en acier peint. Siège et structure de même couleur.

Medidas | Measures | Mesures

W 58,5cm x L 53cm x H 78,5cm x Hs 45,2cm x Ha 65,5cm
W 23,03in x L 20,87in x H 30,91in x Hs 17,8in x Ha 25,79in

Peso | Weight | Poids

7,85 kg

Logística | Logistics | Logistique

2X	216	480	600	960	-



Shape Araña

Giratoria

Designed by Josep Llusçà



Sillón para uso interior. Carcasa inyectada en polipropileno con fibra de vidrio. Estructura de las patas de aluminio pintado en color blanco.

Easy chair for indoor use. Housing injected in polypropylene with fiberglass. Structure made of aluminium painted in white.

Petit fauteuil pour usage intérieur. Siège injecté en polypropylène et fibre de verre. Structure des pieds en aluminium peint en blanc.

Medidas | Measures | Mesures

W 58,5cm x L 53cm x H 78,5cm x Hs 45,2cm x Ha 65,5cm
W 23,03in x L 20,87in x H 30,91in x Hs 17,8in x Ha 25,79in

Peso | Weight | Poids

8,62 kg

Logística | Logistics | Logistique

2X	216	480	600	960	-



Shape

Upholstered seat pad

Designed by Josep Llusca



Tapizado apto para interiores y exteriores. Tejido Sunbrella®. Con espuma de secado rápido. Gramaje 275gr/m2. Solamente es apta para exteriores la versión de Shape con patas click.

Upholstery suitable for indoor and outdoor use. Sunbrella® fabric. With quick-drying foam. Grammage 275gr/m2. Only the Shape Click version is suitable for outdoor use.

Tapisse adapté à l'intérieur et l'extérieur. Tissu Sunbrella®. Avec mousse à séchage rapide. Grammage 275gr/m2. Seule la version Shape Click est adaptée à une utilisation en extérieur.

Upholstered	Structure						
		Gris Oscuro Dark Grey	Toscano Tuscan	Arena Sand	Gris Verdoso Green Grey	Azul Retro Retro Blue	Blanco White
Carbón Coal		•	•	•	•	•	•
Lino Linen		•		•	•	•	•
Taupe Taupe		•	•	•	•	•	•
Mimosa Mimosa		•	•				•
Azul mineral Mineral Blue		•					•

Tapizado | Upholstered | Revêtement



Con espuma de secado rápido
With quick dry foam
Mousse à séchage rapide.

Tapizados aptos para interiores y exteriores
Upholstered suitable for indoor and outdoor
Revêtement apte pour intérieur et extérieur.

Gramaje | Grammage | Grammage

275 gr / m2

Para evitar marcas, por favor no apile las sillas tapizadas.
In order to avoid marks, please do not stack upholstered chairs.
Pour éviter des marques, ne pas empiler les chaises tapissées.



Shape 4 Patas

Fully upholstered

Designed by Josep Llusca

NEW



Sillón tapizado integralmente. Carcasa inyectada en polipropileno con fibra de vidrio. Estructura de las patas en acero pintado.

Fully upholstered armchair. Seat injected in polypropylene with fiberglass. Structure of painted steel.

Fauteuil entièrement tapissé. Siège injectée en polopropylène avec fibre de verre, structure de acier peint.

Medidas | Measures | Measures

W 55,8cm x L 54,5cm x H 78,7cm x Hs 45cm x Ha 66,2cm
W 21,97in x L 21,46in x H 30,98in x Hs 17,72in x Ha 26,06in

Peso | Weight | Poids

6,85 kg

Logística | Logistics | Logistique

Ver opciones de tapizado en página 382.
See upholstery options on page 382.



1X	54	120	120	264	194

Certificaciones | Certifications

UNEEN581-1, UNEEN581-2, UNEEN16139

* Sujeto a condiciones. Por favor, consultar.
* Subject to conditions. Please inquire.
* Sous réserve de conditions. Merci de consulter.



Shape Patin

Fully upholstered

Designed by Josep Llusçà

NEW



Certificaciones | Certifications

UNEEN581-1, UNEEN581-2, UNEEN16139

Sillón tapizado integralmente. Carcasa inyectada en polipropileno con fibra de vidrio. Estructura de las patas en acero pintado.

Fully upholstered armchair. Seat injected in polypropylene with fiberglass. Structure of painted steel.

Fauteuil entièrement tapissé. Siège injectée en polypropylène avec fibre de verre, structure de acier peint.

Medidas | Measures | Mesures

W 58,5cm x L 55,5cm x H 77cm x Hs 45cm x Ha 66cm

W 23,03in x L 21,85in x H 30,31in x Hs 17,72in x Ha 25,98in

Peso | Weight | Poids

8 kg

Logística | Logistics | Logistique

	20'	40'	40' HC	70 m ³	100 m ³
1X	54	120	120	264	194

Ver opciones de tapizado en página 382. See upholstery options on page 382.



Shape Click

Fully upholstered

Designed by Josep Llusçà

NEW



Certificaciones | Certifications

UNEEN581-1, UNEEN581-2, UNEEN16139

Sillón tapizado integralmente. Carcasa y estructura inyectada en polipropileno con fibra de vidrio.

Fully upholstered armchair. Seat and structure injected in polypropylene and fiberglass.

Fauteuil entièrement tapissé. Siège et structure injectée en polypropylène avec fibre de verre.

Medidas | Measures | Mesures

W 58,5cm x L 55cm x H 78,2cm x Hs 45,5cm x Ha 66,8cm

W 23,03in x L 21,65in x H 30,79in x Hs 17,91in x Ha 26,3in

Peso | Weight | Poids

6,68 kg

Logística | Logistics | Logistique

	20'	40'	40' HC	70 m ³	100 m ³
1X	54	120	120	264	194

Ver opciones de tapizado en página 382. See upholstery options on page 382.



Shape Madera

Fully upholstered

Designed by Josep Llusçà

NEW



Certificaciones | Certifications

UNEEN581-1, UNEEN581-2, UNEEN16139

Sillón tapizado integralmente. Carcasa inyectada en polipropileno con fibra de vidrio. Patas de madera de haya.

Fully upholstered armchair. Seat injected in polypropylene with fiberglass. Beech wood legs.

Fauteuil entièrement tapissé. Siège injectée en polypropylène avec fibre de verre. Pieds en bois de hêtre.

Medidas | Measures | Mesures

W 58,5cm x L 55cm x H 78,2cm x Hs 45,5cm x Ha 66,8cm

W 23,03in x L 21,65in x H 30,79in x Hs 17,91in x Ha 26,3in

Peso | Weight | Poids

5,98 kg

Logística | Logistics | Logistique

	20'	40'	40' HC	70 m ³	100 m ³
1X	54	120	120	264	194

Ver opciones de tapizado en página 382. See upholstery options on page 382.



Shape Araña

Fully upholstered

Designed by Josep Llusçà

NEW



Sillón tapizado integralmente. Carcasa inyectada en polipropileno con fibra de vidrio. Estructura de las patas en acero pintado.

Fully upholstered armchair. Seat injected in polypropylene with fiberglass. Structure of painted steel.

Fauteuil entièrement tapissé. Siège injectée en polopropylène avec fibre de verre et structure de acier peint.

Medidas | Measures | Mesures

W 58,5cm x L 53cm x H 78,5cm x Hs 45,2cm x Ha 65,5cm

W 23,03in x L 20,87in x H 30,91in x Hs 17,8in x Ha 25,79in

Peso | Weight | Poids

8,35 kg

Logística | Logistics | Logistique

Ver opciones de tapizado en página 382. See upholstery options on page 382.



	20'	40'	40' HC	70 m ³	100 m ³
1X	54	120	120	264	194

Shape Giratoria

Fully upholstered

Designed by Josep Llusçà

NEW



Sillón tapizado integralmente. Carcasa inyectada en polipropileno con fibra de vidrio. Estructura de las patas en aluminio pintado.

Fully upholstered armchair. Seat injected in polypropylene with fiberglass. Structure of painted aluminum.

Fauteuil entièrement tapissé. Siège injectée en polopropylène avec fibre de verre, structure de aluminium peint.

Medidas | Measures | Mesures

W 58,5cm x L 53cm x H 78,5cm x Hs 45,2cm x Ha 65,5cm

W 23,03in x L 20,87in x H 30,91in x Hs 17,8in x Ha 25,79in

Peso | Weight | Poids

9,12 kg

Logística | Logistics | Logistique

Ver opciones de tapizado en página 382. See upholstery options on page 382.



	20'	40'	40' HC	70 m ³	100 m ³
1X	54	120	120	264	194

Shape Ruedas

Fully upholstered

Designed by Josep Llusçà

NEW



Sillón tapizado integralmente. Carcasa inyectada en polipropileno con fibra de vidrio. Estructura de ruedas con bomba.

Fully upholstered armchair. Seat injected in polypropylene with fiberglass. Structure of castors with pump.

Fauteuil entièrement tapissé. Siège injectée en polopropylène avec fibre de verre, structure de roue avec pompe.

Medidas | Measures | Mesures

W 62cm x L 62cm x H 77,7cm x Hs 43cm x Ha 66cm

W 24,41in x L 24,41in x H 30,51in x Hs 17,2in x Ha 25,98in

Peso | Weight | Poids

11,48 kg

Logística | Logistics | Logistique

Ver opciones de tapizado en página 382. See upholstery options on page 382.



	20'	40'	40' HC	70 m ³	100 m ³
1X	54	120	120	264	194



Angie 4 Patas

Designed by Josep Llusçà

Silla con brazos para uso interior. Carcasa inyectada en PP y fibra de vidrio. Estructura de acero pintado.

Chair for indoor use injected in PP and fiberglass. Structure made of painted steel.

Chaise pour une utilisation intérieure injecté en PP et fibre de verre. Structure en acier peint.



Medidas | Measures | Mesures

W 58,5cm x L 53cm x H 78,5cm x Hs 43,5cm x Ha 65cm
W 23,03in x L 20,87in x H 30,91in x Hs 17,13in x Ha 25,59in

Peso | Weight | Poids Apilado | Stackable | Empilable

6,15 kg 4 unidades | units | unités

Logística | Logistics | Logistique

	20'	40'	40' HC	70 m ³	100 m ³
2X	132	304	360	480	696
4X	216	456	456	520	696



Angie Patin

Designed by Josep Llusçà

Silla con brazos patín para uso interior. Carcasa inyectada en fibra de vidrio y PP. Estructura de acero pintado. Apilable.

Chair with sled base arms for indoor use. Housing injected in fiberglass and PP. Painted steel structure. Stackable.

Chaise avec accoudoirs patin pour usage intérieur. Siège injecté en fibre de verre et PP. Structure en acier peint. Empilable.



Medidas | Measures | Mesures

W 58,5cm x L 53cm x H 78,5cm x Hs 43,5cm x Ha 65cm
W 23,03in x L 20,87in x H 30,91in x Hs 17,13in x Ha 25,59in

Peso | Weight | Poids Apilado | Stackable | Empilable

7,25 kg 4 unidades | units | unités

Logística | Logistics | Logistique

	20'	40'	40' HC	70 m ³	100 m ³
2X	132	304	360	480	696
4X	216	456	456	520	696



Angie Click

Designed by Josep Llusçà

Silla con brazos para uso interior y exterior inyectada en PP y fibra de vidrio. Estructura con sistema click.

Chair for indoor and outdoor use injected in PP and fiberglass with a click system structure.

Chaise pour une utilisation intérieure et extérieure injecté en PP et fibre de verre. Structure avec click system.



Medidas | Measures | Mesures

W 58,5cm x L 53cm x H 78,5cm x Hs 45cm x Ha 66cm
W 23,03in x L 20,87in x H 30,91in x Hs 17,72in x Ha 25,98in

Peso | Weight | Poids

5,8 kg

Logística | Logistics | Logistique

	20'	40'	40' HC	70 m ³	100 m ³
2X	132	342	360	532	-



Angie Madera

Designed by Josep Llusçà



Sillón para uso interior. Carcasa asiento y base de patas inyectadas en polipropileno con fibra de vidrio. Patas de madera. Sistema de montaje mediante clipaje. Protección UV.

Armchair for indoor use. Seat frame and leg structure injected with polypropylene with fibreglass. Wooden legs. Clip-on assembly system. UV protection.

Fauteuil pour usage intérieur. Siège et base des pieds injectés en polypropylène et fibre de verre. Pieds en bois. Système de montage par clippage. Protection UV.

Medidas | Measures | Measures

W 58,5cm x L 53cm x H 78,5cm x Hs 45cm x Ha 66cm
W 23,03in x L 20,87in x H 30,91in x Hs 17,72in x Ha 25,98in

Peso | Weight | Poids

5,54 kg

Logística | Logistics | Logistique

	20'	40'	40 HC	70 m ³	100 m ³
2X	216	480	600	960	-

- Gris Cachemira
Cashmere Grey
- Chocolate
Chocolate
- Blanco
White
- Verde Oliva
Olive Green *
- Arena
Sand *



Angie Araña

Designed by Josep Llusçà



Silla con brazos araña para uso interior. Carcasa inyectada en fibra de vidrio y PP. Estructura de acero pintado.

Chair with spider arms for indoor use. Housing injected in fiberglass and PP. Painted steel structure.

Chaise avec accoudoirs araignée pour usage intérieur. Siège injecté en fibre de verre et PP. Structure en acier peint.

Medidas | Measures | Measures

W 58,5cm x L 53cm x H 78,5cm x Hs 43,5cm x Ha 65cm
W 23,03in x L 20,87in x H 30,91in x Hs 17,13in x Ha 25,59in

Peso | Weight | Poids

5,65 kg

Logística | Logistics | Logistique

	20'	40'	40 HC	70 m ³	100 m ³
2X	162	342	456	552	-

- Gris Cachemira
Cashmere Grey
- Chocolate
Chocolate
- Blanco
White
- Verde Oliva
Olive Green *
- Arena
Sand *



Angie Araña Giratoria

Designed by Josep Llusçà



Silla con brazos araña para uso interior. Carcasa inyectada en fibra de vidrio y PP. Estructura de aluminio pintado.

Chair with spider arms for indoor use. Housing injected in fiberglass and PP. Painted aluminum structure.

Chaise avec accoudoirs araignée pour usage intérieur. Siège injecté en fibre de verre et PP. Structure en aluminium peint.

Medidas | Measures | Measures

W 58,5cm x L 53cm x H 78,5cm x Hs 43,5cm x Ha 65cm
W 23,03in x L 20,87in x H 30,91in x Hs 17,13in x Ha 25,59in

Peso | Weight | Poids

6,65 kg

Logística | Logistics | Logistique

	20'	40'	40 HC	70 m ³	100 m ³
2X	162	342	456	522	-

- Chocolate/Blanco
Chocolate/White
- Blanco
White
- Gris Cachemira/Negro
Cashmere Grey/Black
- Verde Oliva/Negro
Olive Green/Black *
- Arena/Negro
Sand/Black *



* Sujeto a condiciones. Por favor, consultar.
* Subject to conditions. Please inquire.
* Sous réserve de conditions. Merci de consulter.



Angie

Upholstered seat pad

Designed by Josep Llusà

Tapizado apto para interiores con tejido FIDIVI JET de 100% Polyester Trevira CS. Gramaje 260 g/m².

Upholstery suitable for indoor use with 100% Polyester Trevira CS FIDIVI JET fabric. Weight 260 g/m².

Tapissé adapté à une utilisation en intérieur avec tissu FIDIVI JET 100% Polyester Trevira CS. Poids 260 g/m².



Upholstered	Structure	●*	●*	●	●	○
		Verde Oliva Olive Green	Arena Sand	Gris Cachemira	Chocolate Chocolate	Bianco White
Jet 8033		●	●	●	●	●
Jet 6007		●	●	●	●	●
Jet 3019		●	●	●	●	●
Jet 7041		●	●	●	●	●
Jet 9404		●	●	●	●	●
Jet 1006		●	●	●	●	●
Jet 9109		●	●	●	●	●
Jet 2012		●	●	●	●	●

Tapizado | Upholstered | Revêtement



Gramaje | Grammage | Grammage

260 gr / m²

Para evitar marcas, por favor no apile las sillas tapizadas.

In order to avoid marks, please do not stack upholstered chairs.

Pour éviter des marques, ne pas empiler les chaises tapissées.



Skin 4 Patas

Designed by Josep Llusçà

Silla para uso interior. Carcasa inyectada en PP y fibra de vidrio. Estructura de acero pintado.

Chair for indoor use injected in PP and fiberglass. Structure made of painted steel.

Chaise pour une utilisation intérieure injecté en PP et fibre de verre. Structure en acier peint.



Certificaciones | Certifications

UNEEN581-1, UNEEN581-2, UNEEN16139 L1

Medidas | Measures | Mesures

W 51,7cm x L 54,4cm x H 77,7cm x Hs 43cm

W 20,35in x L 21,42in x H 30,59in x Hs 16,93in

Peso | Weight | Poids

4,91 kg

Apilado | Stackable | Empilable

10 unidades | units | unités

Logística | Logistics | Logistique

	20'	40'	40 HC	70 m ³	100 m ³
2X	138	304	304	-	436
4X	176	400	400	-	528



Skin Patin

Designed by Josep Llusçà

Silla para uso interior. Carcasa inyectada en PP y fibra de vidrio. Estructura de acero pintado.

Chair for indoor use injected in PP and fiberglass. Structure made of painted steel.

Chaise pour une utilisation intérieure injecté en PP et fibre de verre. Structure en acier peint.



Certificaciones | Certifications

UNEEN581-1, UNEEN581-2, UNEEN16139 L1

Medidas | Measures | Mesures

W 54cm x L 52cm x H 79cm x Hs 43cm

W 21,26in x L 20,47in x H 31,1in x Hs 16,93in

Peso | Weight | Poids

7,51 kg

Apilado | Stackable

10 unidades | units | unités

Logística | Logistics | Logistique

	20'	40'	40 HC	70 m ³	100 m ³
2X	138	304	304	-	436
4X	176	400	400	-	528



Skin Click

Designed by Josep Llusçà

Silla para uso interior y exterior inyectada en PP y fibra de vidrio. Estructura con sistema click.

Chair for indoor and outdoor use injected in PP and fiberglass with a click system structure.

Chaise pour une utilisation intérieure et extérieure injecté en PP et fibre de verre. Structure avec click system.



Certificaciones | Certifications

UNEEN581-1, UNEEN581-2, UNEEN16139 L1

Medidas | Measures | Mesures

W 46cm x L 50cm x H 78,5cm x Hs 46,5cm

W 18,11in x L 19,69in x H 30,91in x Hs 18,31in

Peso | Weight | Poids

5,25 kg

Logística | Logistics | Logistique

	20'	40'	40 HC	70 m ³	100 m ³
2X	138	304	304	436	-



Skin Madera

Designed by Josep Llusçà



Silla para uso interior. Carcasa asiento y base de patas inyectadas en polipropileno con fibra de vidrio. Patas de madera. Sistema de montaje mediante clipaje. Protección UV.

Chaire for indoor use. Seat frame and leg structure injected with polypropylene with fiberglass. Wooden legs. Clip-on assembly system. UV protection.

Chaise pour usage intérieur. Siège et base des pieds injectés en polypropylène et fibre de verre. Pieds en bois. Système de montage par clippage. Protection UV.

Medidas | Measures | Measures

W 46cm x L 50cm x H 78,5cm x Hs 46,5cm
W 18,11in x L 19,69in x H 30,91in x Hs 18,31in

Peso | Weight | Poids

4,86 kg

Logística | Logistics | Logistique

2X	312	688	784	864	1.072



Skin Araña

Designed by Josep Llusçà



Silla para uso interior. Carcasa inyectada en PP y fibra de vidrio. Estructura de acero pintado.

Chair for indoor use injected in PP and fiberglass. Structure made of painted steel.

Chaise pour une utilisation intérieure injecté en PP et fibre de verre. Structure en acier peint.

Medidas | Measures | Measures

W 49cm x L 53,4cm x H 77,5cm x Hs 43,7cm
W 19,29in x L 21,02in x H 30,51in x Hs 17,2in

Peso | Weight | Poids

6,87 kg

Logística | Logistics | Logistique

2X	138	304	304	-	436



Skin Ruedas

Designed by Josep Llusçà



Silla para uso interior de carcasa inyectada en polipropileno con fibra de vidrio. Estructura de ruedas con bomba.

Chair for indoor use, seat injected in polypropylene with fiberglass. Structure of castors with pump.

Chaise pour usage intérieur. Siège injectée en polypropylène avec fibre de verre, structure de roue avec pompe.

Medidas | Measures | Measures

W 62cm x L 62cm x H 74,7cm x Hs 40cm
W 24,41in x L 24,41in x H 29,41in x Hs 15,75in

Peso | Weight | Poids

10 kg

Logística | Logistics | Logistique

2X	152	304	319	-	-



Skin

Upholstered seat pad

Designed by Josep Llusçà



Tapizado | Upholstered | Revêtement

SPRADLING®

Para evitar marcas, por favor no apile las sillas tapizadas.

In order to avoid marks, please do not stack upholstered chairs.

Pour éviter des marques, ne pas empiler les chaises tapissées.

Carcasa inyectada en PP y fibra de vidrio. Estructura de acero pintado. Asiento tapizado en tejido Spradling.

Chair injected in PP and fiberglass. Seat pad upholstered with Spradling fabric.

Chaise injecté en PP et fibre de verre. Assise tapissé de tissu Spradling.



Accesorios

para Skin 4 Patas y Patín

Accessories

for Skin 4 Legs and Sled Base

Accessoires

pour Skin 4 Pieds et Base Luge



Mesa auxiliar. Solo para Skin 4 patas.
Auxiliary table. Only for Skin 4 legs.
Table d'appoint. Pour Skin 4 pattes.



Varilla unión sillas
Rod to link accessory
Branche union chaise



Carro porta sillas
Trolley for chairs
Chariot porte-chaises

Skin 4 Patas

armchair

Designed by Josep Llusçà



Certificaciones | Certifications

UNEEN581-1, UNEEN581-2, UNEEN16139 LI

Silla para uso interior. Carcasa inyectada en PP y fibra de vidrio. Estructura de acero pintado.

Chair for indoor use injected in PP and fiberglass. Structure made of painted steel.

Chaise pour une utilisation intérieure injecté en PP et fibre de verre. Structure en acier peint.

Medidas | Measures | Measures

W 56cm x L 54,4cm x H 77,7cm x Hs 43cm x Ha 65,5cm
W 22,05in x L 21,42in x H 30,59in x Hs 16,93in x Ha 25,79in

Peso | Weight | Poids Apilado | Stackable | Empilable

5,51 kg 10 unidades | units | unités

Logística | Logistics | Logistique



		20'	40'	40 HC	70 m ³	100 m ³
	2X	138	304	304	-	436
	4X	176	400	400	-	528

Skin Patin

armchair

Designed by Josep Llusçà



Gold Award
MIFF 2015

Certificaciones | Certifications

UNEEN581-1, UNEEN581-2, UNEEN16139 L1

Silla para uso interior. Carcasa inyectada en PP y fibra de vidrio. Estructura de acero pintado o cromado.

Chair for indoor use injected in PP and fiberglass. Structure made of painted or chromed steel.

Chaise pour une utilisation intérieure injectée en PP et fibre de verre. Structure en acier peint ou chromé.

Medidas | Measures | Mesures

W 56cm x L 52cm x H 79cm x Hs 43cm x Ha 65,5cm
W 22,05in x L 20,47in x H 31,1in x Hs 16,93in x Ha 25,79in

Peso | Weight | Poids Apilado | Stackable

7,11 kg 8 unidades | units | unités

Logística | Logistics | Logistique

	20'	40'	40' HC	70 m ³	100 m ³
2X	138	304	304	-	436
4X	176	400	400	-	528



Skin Araña

armchair

Designed by Josep Llusçà



Gold Award
MIFF 2015

Silla para uso interior. Carcasa inyectada en PP y fibra de vidrio. Estructura de acero pintado o cromado.

Chair for indoor use injected in PP and fiberglass. Structure made of painted or chromed steel.

Chaise pour une utilisation intérieure injectée en PP et fibre de verre. Structure en acier peint ou chromé.

Medidas | Measures | Mesures

W 56cm x L 53,4cm x H 77,5cm x Hs 43,7cm x Ha 65,5cm
W 22,05in x L 21,02in x H 30,51in x Hs 17,2in x Ha 25,79in

Peso | Weight | Poids

7,48 kg

Logística | Logistics | Logistique

	20'	40'	40' HC	70 m ³	100 m ³
2X	138	304	304	-	-



Skin Ruedas

armchair

Designed by Josep Llusçà



Gold Award
MIFF 2015

Silla para uso interior de carcasa inyectada en polipropileno con fibra de vidrio. Estructura de ruedas con bomba.

Chair for indoor use, seat injected in polypropylene with fiberglass. Structure of castors with pump.

Chaise pour usage intérieur. Siège injectée en polypropylène avec fibre de verre, structure de roue avec pompe.

Medidas | Measures | Mesures

W 62cm x L 62cm x H 74,7cm x Hs 40cm x Ha 62,5cm
W 24,41in x L 24,41in x H 29,41in x Hs 15,75in x Ha 24,61in

Peso | Weight | Poids

10,99 kg

Logística | Logistics | Logistique

	20'	40'	40' HC	70 m ³	100 m ³
2X	152	304	319	-	-



Skin 4 Patas

Fully upholstered

Designed by Josep Llusçà

NEW



Silla de tapizado integral. Carcasa inyectada en polipropileno con fibra de vidrio. Estructura de las patas en acero pintado.

Fully upholstered chair. Seat injected in polypropylene with fiberglass. Structure of painted steel.

Chaise entièrement tapissée. Siège injecté en polypropylène avec fibre de verre, structure de acier peint.

Medidas | Measures | Mesures

W 51,7cm x L 54,4cm x H 77,7cm x Hs 43cm

W 20,35in x L 21,42in x H 30,59in x Hs 16,93in

Peso | Weight | Poids

5,41 kg

Logística | Logistics | Logistique

Ver opciones de tapizado en página 382. See upholstery options on page 382.



Certificaciones | Certifications

UNEEN581-1, UNEEN581-2, UNEEN16139, UNEEN1728

	108	228	228	270	348

Skin Patin

Fully upholstered

Designed by Josep Llusçà

NEW



Silla de tapizado integral. Carcasa inyectada en polipropileno con fibra de vidrio. Estructura de las patas en acero pintado.

Fully upholstered chair. Seat injected in polypropylene with fiberglass. Structure of painted steel.

Chaise entièrement tapissée. Siège injecté en polypropylène avec fibre de verre, structure de acier peint.

Medidas | Measures | Mesures

W 54cm x L 52cm x H 79cm x Hs 43cm

W 21,26in x L 20,47in x H 31,1in x Hs 16,93in

Peso | Weight | Poids

8,01 kg

Logística | Logistics | Logistique

Ver opciones de tapizado en página 382. See upholstery options on page 382.



Certificaciones | Certifications

UNEEN581-1, UNEEN581-2, UNEEN16139, UNEEN1728

	108	228	228	270	348

Skin Click

Fully upholstered

Designed by Josep Llusçà

NEW



Silla tapizada integralmente. Carcasa y estructura inyectada en polipropileno con fibra de vidrio.

Fully upholstered chair. Seat and structure injected in polypropylene and fiberglass.

Chaise entièrement tapissée. Siège et structure injectée en polypropylène avec fibre de verre.

Medidas | Measures | Mesures

W 46cm x L 50cm x H 78,5cm x Hs 46,5cm

W 18,11in x L 19,69in x H 30,91in x Hs 18,31in

Peso | Weight | Poids

5,75 kg

Logística | Logistics | Logistique

Ver opciones de tapizado en página 382. See upholstery options on page 382.



Certificaciones | Certifications

UNEEN581-1, UNEEN581-2, UNEEN16139

	54	120	120	264	194

Skin Madera

Fully upholstered

Designed by Josep Llusçà

NEW



Certificaciones | Certifications

UNEEN581-1, UNEEN581-2, UNEEN16139

Silla tapizada integralmente. Carcasa inyectada en polipropileno con fibra de vidrio. Patas de madera de haya.

Fully upholstered chair. Seat injected in polypropylene with fiberglass. Beech wood legs.

Chaise entièrement tapissée. Siège injectée en polypropylène avec fibre de verre. Pieds en bois de hêtre.

Medidas | Measures | Mesures

W 46cm x L 50cm x H 78,5cm x Hs 46,5cm

W 18,11in x L 19,69in x H 30,91in x Hs 18,31in

Peso | Weight | Poids

5,36 kg

Logística | Logistics | Logistique

	20'	40'	40' HC	70 m ³	100 m ³
1X	54	120	120	264	194

Ver opciones de tapizado en página 382. See upholstery options on page 382.



Skin Araña

Fully upholstered

Designed by Josep Llusçà

NEW



Silla tapizada integralmente. Carcasa inyectada en polipropileno con fibra de vidrio. Estructura de las patas en acero pintado.

Fully upholstered chair. Seat injected in polypropylene with fiberglass. Structure of painted steel.

Chaise entièrement tapissée. Siège injectée en polypropylène avec fibre de verre, structure de acier peint.

Medidas | Measures | Mesures

W 49cm x L 53,4cm x H 77,5cm x Hs 43,7cm

W 19,29in x L 21,02in x H 30,51in x Hs 17,2in

Peso | Weight | Poids

7,37 kg

Logística | Logistics | Logistique

	20'	40'	40' HC	70 m ³	100 m ³
1X	54	120	120	264	194

Ver opciones de tapizado en página 382. See upholstery options on page 382.



Skin Araña Giratoria

Fully upholstered

Designed by Josep Llusçà

NEW



Silla de tapizado integral. Carcasa inyectada en polipropileno con fibra de vidrio. Estructura de las patas en aluminio pintado.

Fully upholstered chair. Seat injected in polypropylene with fiberglass. Structure of painted aluminum.

Chaise entièrement tapissée. Siège injectée en polypropylène avec fibre de verre, structure de aluminium peint.

Medidas | Measures | Mesures

W 49cm x L 53,4cm x H 77,5cm x Hs 43,7cm

W 19,29in x L 21,02in x H 30,51in x Hs 17,2in

Peso | Weight | Poids

8,14 kg

Logística | Logistics | Logistique

	20'	40'	40' HC	70 m ³	100 m ³
1X	54	120	120	264	194

Ver opciones de tapizado en página 382. See upholstery options on page 382.



Skin Ruedas

Fully upholstered

Designed by Josep Llusçà

NEW



Silla tapizada integralmente. Carcasa inyectada en polipropileno con fibra de vidrio. Estructura de ruedas con bomba.

Fully upholstered chair. Seat injected in polypropylene with fiberglass. Structure of castors with pump.

Chaise entièrement tapissée. Siège injectée en polopropylène avec fibre de verre, structure de roue avec pompe.

Medidas | Measures | Mesures

W 62cm x L 62cm x H 74,7cm x Hs 40cm
W 24,41in x L 24,41in x H 29,41in x Hs 15,75in

Peso | Weight | Poids

10,5 kg

Logística | Logistics | Logistique

Ver opciones de tapizado en página 382. See upholstery options on page 382.

	20'	40'	40 HC	70 m ³	100 m ³
1X	54	120	120	264	194

Wire 4 Patas

Designed by Josep Llusçà



Silla para uso interior. Carcasa inyectada en fibra de vidrio y PP. Estructura de acero pintado. Apilable. Estructura y asiento del mismo color

Chair for indoor use. Seat injected with fiberglass and PP. Structure made of painted steel. Structure and seat of the same colour. Stackable.

Chaise pour usage intérieur. Siège injecté en fibre de verre et PP. Structure en acier peint. Empilable. Structure et assise de la même couleur

Medidas | Measures | Mesures

W 51,7cm x L 54,4cm x H 77,7cm x Hs 43cm
W 20,35in x L 21,42in x H 30,59in x Hs 16,93in

Peso | Weight | Poids **Apilado | Stackable | Empilable**

4,91 kg 10 unidades | units | unités

Logística | Logistics | Logistique



	20'	40'	40 HC	70 m ³	100 m ³
2X	132	306	372	416	540
4X	260	548	632	652	912

Certificaciones | Certifications

UNEEN581-1, UNEEN581-2, UNEN16139

Wire Patin

Designed by Josep Llusçà



Silla patín para uso interior. Carcasa inyectada en fibra de vidrio y PP. Estructura de acero pintado. Apilable. Estructura y asiento del mismo color

Chair for indoor use. Seat injected with fiberglass and PP. Structure made of painted steel. Structure and seat of the same colour. Stackable.

Chaise patin pour usage intérieur. Siège injecté en fibre de verre et PP. Structure en acier peint. Empilable. Structure et assise de la même couleur

Medidas | Measures | Mesures

W 54cm x L 52cm x H 79cm x Hs 43cm
W 21,26in x L 20,47in x H 31,1in x Hs 16,93in

Peso | Weight | Poids **Apilado | Stackable | Empilable**

5,51 kg 4 unidades | units | unités

Logística | Logistics | Logistique



	20'	40'	40 HC	70 m ³	100 m ³
2X	132	306	372	416	540
4X	260	548	632	652	912

Certificaciones | Certifications

UNEEN581-1, UNEEN581-2, UNEN16139

Wire Madera

Designed by Josep Llusçà



Silla para uso interior. Carcasa asiento y base de patas inyectadas en polipropileno con fibra de vidrio. Patas de madera. Sistema de montaje mediante clipaje. Protección UV.

Chair for indoor use. Seat frame and leg structure injected with polypropylene with fiberglass. Wooden legs. Clip-on assembly system. UV protection.

Chaise pour usage intérieur. Siège et base des pieds injectés en polypropylène et fibre de verre. Pieds en bois. Système de montage par clippage. Protection UV.

Medidas | Measures | Mesures

W 46cm x L 50cm x H 78,5cm x Hs 46,5cm
W 18,11in x L 19,69in x H 30,91in x Hs 18,31in



Peso | Weight | Poids

4,54 kg

Logística | Logistics | Logistique

	20'	40'	40' HC	70 m ³	100 m ³
	2	312	688	864	1.072

Certificaciones | Certifications

UNEEN581-1, UNEEN581-2

Wire Click

Designed by Josep Llusçà



Silla para uso interior y exterior inyectada en PP y fibra de vidrio. Estructura con sistema click.

Chair for indoor and outdoor use injected in PP and fiberglass with a click system structure.

Chaise pour une utilisation intérieure et extérieure injecté en PP et fibre de verre. Structure avec click system.

Medidas | Measures | Mesures

W 46cm x L 50cm x H 78,5cm x Hs 46,5cm
W 18,11in x L 19,69in x H 30,91in x Hs 18,31in



Peso | Weight | Poids

6,87 kg

Logística | Logistics | Logistique

	20'	40'	40' HC	70 m ³	100 m ³
	2X	312	688	864	1.072

Certificaciones | Certifications

UNENI6139, UNEEN581-2, UNEEN581-1

Wire Araña

Designed by Josep Llusçà



Silla araña para uso interior. Carcasa inyectada en fibra de vidrio y PP. Estructura de acero pintado. Estructura y asiento del mismo color.

Chair for indoor use. Seat injected with fiberglass and PP. Structure made of painted steel. Structure and seat of the same colour. Stackable.

Chaise araignée pour usage intérieur. Siège injecté en fibre de verre et PP. Structure en acier peint. Structure et assise de la même couleur.

Medidas | Measures | Mesures

W 49cm x L 53,4cm x H 77,5cm x Hs 43,7cm
W 19,29in x L 21,02in x H 30,51in x Hs 17,2in



Peso | Weight | Poids

6,87 kg

Logística | Logistics | Logistique

	20'	40'	40' HC	70 m ³	100 m ³
	2X	312	688	864	1.072

Certificaciones | Certifications

UNEEN581-1, UNEEN581-2, UNENI6139

Wire 4 Patas

armchair

Designed by Josep Llusçà



Silla con brazos para uso interior. Carcasa inyectada en fibra de vidrio y PP. Estructura de acero pintado. Apilable. Estructura y asiento del mismo color

Chair for indoor use. Seat injected with fiberglass and PP. Structure made of painted steel. Structure and seat of the same colour. Stackable.

Chaise avec accoudoirs pour usage intérieur. Siège injecté en fibre de verre et PP. Structure en acier peint. Empilable. Structure et assise de la même couleur

Medidas | Measures | Measures

W 56cm x L 54,4cm x H 77,7cm x Hs 43cm x Ha 65,5cm
W 22,05in x L 21,42in x H 30,59in x Hs 16,93in x Ha 25,79in

Peso | Weight | Poids Apilado | Stackable | Empilable

5,51 kg 10 unidades | units | unités

Logística | Logistics | Logistique

	20'	40'	40 HC	70 m ³	100 m ³
2X	132	306	372	416	540
4X	260	548	632	652	912



Certificaciones | Certifications

UNEEN581-1, UNEEN581-2, UNEN16139

Wire Patin

armchair

Designed by Josep Llusçà



Silla patín con brazos para uso interior. Carcasa inyectada en fibra de vidrio y PP. Estructura de acero pintado. Estructura y asiento del mismo color

Slade base chair for indoor use. Seat injected with fiberglass and PP. Structure made of painted steel. Structure and seat of the same colour. Stackable.

Chaise patin avec accoudoirs pour usage intérieur. Siège injecté en fibre de verre et PP. Structure en acier peint. Structure et assise de la même couleur

Medidas | Measures | Measures

W 56cm x L 52cm x H 79cm x Hs 43cm x Ha 65,5cm
W 22,05in x L 20,47in x H 31,1in x Hs 16,93in x Ha 25,79in

Peso | Weight | Poids Apilado | Stackable | Empilable

5,51 kg 4 unidades | units | unités

Logística | Logistics | Logistique

	20'	40'	40 HC	70 m ³	100 m ³
2X	132	306	372	416	912
4X	260	548	632	652	912



Certificaciones | Certifications

UNEEN581-1, UNEEN581-2, UNEN16139

Wire Araña

armchair

Designed by Josep Llusçà



Silla araña con brazos para uso interior. Carcasa inyectada en fibra de vidrio y PP. Estructura de acero pintado. Estructura y asiento del mismo color

Spider base chair for indoor use. Seat injected with fiberglass and PP. Structure made of painted steel. Structure and seat of the same colour. Stackable.

Chaise araignée avec accoudoirs pour usage intérieur. Siège injecté en fibre de verre et PP. Structure en acier peint. Structure et assise de la même couleur

Medidas | Measures | Measures

W 56cm x L 53,4cm x H 77,5cm x Hs 43,7cm x Ha 65,5cm
W 22,05in x L 21,02in x H 30,51in x Hs 17,2in x Ha 25,79in

Peso | Weight | Poids

7,48 kg

Logística | Logistics | Logistique

	20'	40'	40 HC	70 m ³	100 m ³
2X	312	688	784	864	1.072



Certificaciones | Certifications

UNEEN581-1, UNEEN581-2, UNEN16139

* Sujeto a condiciones. Por favor, consultar.
* Subject to conditions. Please inquire.
* Sous réserve de conditions. Merci de consulter.

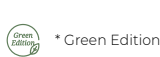

Boss

Designed by Joan Gaspar



Silla plegable para uso interior y exterior. Inyectado en polipropileno con fibra de vidrio. Protección UV. Textilene de 850 gr.

Folding chair for indoor and outdoor use. Injected in polypropylene with fiberglass. UV protection. Batyline Iso textilene from Serge Ferrari.

Chaise pliante d'intérieur et extérieur. Injecté en polypropylène avec fibre de verre. Protection UV. Textilène Batyline ISO de 850 gr.

Medidas | Measures | Mesures

W 53,5cm x L 49cm x H 85cm x Hs 47cm x Ha 60,5cm
W 21,06in x L 19,29in x H 33,46in x Hs 18,5in x Ha 23,82in

Peso | Weight | Poids

5 kg

Logística | Logistics | Logistique

	20'	40'	40' HC	70 m ³	100 m ³
2X	800	1752	1826	2680	2376

Certificaciones | Certifications

UNEN16139, UNEEN581-1

Estructura | Structure | Structure



Textilene | Textilene | Textilène

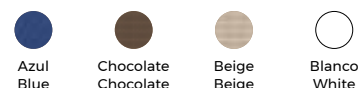

Boss Soft

Designed by Joan Gaspar



Silla plegable para uso interior y exterior. Inyectado en polipropileno con fibra de vidrio. Protección UV. Tapizado apto para interiores y exteriores. Composición Sunbrella®. Con espuma de secado rápido.

Folding chair for indoor and outdoor use. Injected in polypropylene with fiberglass. UV protection. Sunbrella Fabric®.

Chaise pliante d'intérieur et extérieur. Injecté en polypropylène avec fibre de verre. Protection UV. Tissu Sunbrella®.

Medidas | Measures | Mesures

W 53,5cm x L 49cm x H 85cm x Hs 47cm x Ha 60,5cm
W 21,06in x L 19,29in x H 33,46in x Hs 18,5in x Ha 23,82in

Peso | Weight | Poids

5 kg

Logística | Logistics | Logistique

	20'	40'	40' HC	70 m ³	100 m ³
2X	850	1752	2008	2680	2842



Certificaciones | Certifications

UNEEN581-1, UNEEN581-2



Bini

Designed by Joan Gaspar

NEW



Silla para uso interior y exterior. Fabricada en polipropileno con fibra de vidrio. Protección UV.

Chair for indoor and outdoor use. Polypropylene injected frame with fibreglass. UV protection.

Chaise pour usage intérieur et extérieur. Fabriquée en polypropylène et fibre de verre. Protection UV.

Medidas | Measures | Mesures

W 60cm x L 60cm x H 86,6cm
W 23,62in x L 23,62in x H 34,09in

Peso | Weight | Poids | Apilado | Stackable | Empilable

4,825 kg

9 unidades | units | unités

Logística | Logistics | Logistique

	20'	40'	40' HC	70 m ³	100 m ³
2X	134	316	362	480	536
4X	256	524	572	800	800
P24	576	1152	1152	1296	1344



Certificaciones | Certifications

UNEEN581-1, UNEEN581-2

Smart

Upholstered seat pad

Designed by Javier Cuñado

NEW



Silla para uso interior y exterior. Fabricada en polipropileno con fibra de vidrio mediante tecnología de moldeo asistida por gas. Protección UV. Con espuma de secado rápido. Tapizados aptos para interiores y exteriores. Gramaje 275 gr/m2

Chair for indoor and outdoor use. Manufactured in polypropylene with fibreglass using gas-assisted moulding technology. UV protection. With quick-drying foam. Upholstery suitable for indoor and outdoor use. Grammage 275 gr/m2

Chaise pour usage intérieur et extérieur. Fabriquée en polypropylène avec fibre de verre, par technologie d'injection assistée par gaz. Protection UV. Avec mousse à séchage rapide. Tapissés adaptés à l'intérieur et l'extérieur. Grammage 275 gr/m2

Medidas | Measures | Measures

W 49,3cm x L 55,8cm x H 81,4cm x Hs 48cm
W 19,41in x L 21,97in x H 32,05in x Hs 18,9in

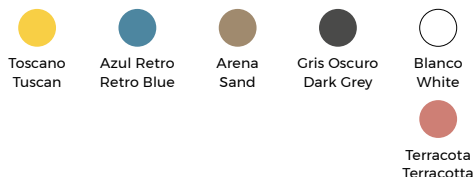

Peso | Weight | Poids Apilado | Stackable | Empilable

4,8 kg 9 unidades | units | unités

Logística | Logistics | Logistique

	20'	40'	40' HC	70 m ³	100 m ³
2X	134	316	362	480	536
4X	152	308	332	424	436
P26	624	1248	1248	1404	1456

Certificaciones | Certifications

ANSI BIFMA X5.1

Smart armchair

Upholstered seat pad

Designed by Javier Cuñado

NEW



Silla con brazos para uso interior y exterior. Fabricada en polipropileno con fibra de vidrio mediante tecnología de moldeo asistida por gas. Protección UV. Con espuma de secado rápido. Tapizados aptos para interiores y exteriores. Gramaje 275 gr/m2

Chair with arms for indoor and outdoor use. Manufactured in polypropylene with fibreglass using gas-assisted moulding technology. UV protection. With quick-drying foam. Upholstery suitable for indoor and outdoor use. Grammage 275 gr/m2

Chaise avec accoudoirs pour usage intérieur et extérieur. Fabriquée en polypropylène avec fibre de verre, par technologie d'injection assistée par gaz. Protection UV. Avec mousse à séchage rapide. Tapissés adaptés à l'intérieur et l'extérieur. Grammage 275 gr/m2

Medidas | Measures | Measures

W 59cm x L 55,8cm x H 81,4cm x Hs 48cm x Ha 67cm
W 23,23in x L 21,97in x H 32,05in x Hs 18,9in x Ha 26,38in

Peso | Weight | Poids Apilado | Stackable | Empilable

5,24 kg 9 unidades | units | unités

	Structure	Terracota Terracotta	Toscano Tuscan	Azul Retro Retro Blue	Arena Sand	Gris Oscuro Dark Grey	Blanco White
Upholstered							
Carbón Coal		•	•	•	•	•	•
Lino Linen		•	•	•	•	•	•
Negro Sunbrella Black Sunbrella		•	•	•	•	•	•
Taupe Taupe		•	•	•	•	•	•
Azul mineral Mineral Blue						•	•
Calabaza Pumpkin						•	•
Mimosa Mimosa						•	•

Certificaciones | Certifications

ANSI BIFMA X5.1

Tapizado | Upholstered | Revêtement



Con espuma de secado rápido.

With quick dry foam.

Mousse à séchage rapide.

Tapizados aptos para interiores y exteriores.

Upholstered suitable for indoor and outdoor.

Revêtement apte pour intérieur et extérieur.

Gramaje | Grammage | Grammage

275 gr / m2

Su diseño permite apilar sin dejar marcas en el tejido.

Its design allows stacking without leaving marks on the fabric.

Sa désign permet un empilage sans laisser de traces sur le tissu.

Logística | Logistics | Logistique

	20'	40'	40' HC	70 m ³	100 m ³
2X	134	316	362	480	536
4X	256	524	572	800	800
P20	480	960	960	1080	1120

Como

Designed by Joan Gaspar

NEW



Certificaciones | Certifications

NFEN581-1, UNEN16139

Silla para uso interior y exterior. Fabricada en polipropileno con fibra de vidrio mediante tecnología de moldeo asistida por gas. Protección UV.

Chair for indoor and outdoor use. Manufactured in polypropylene with fibreglass using gas-assisted moulding technology. UV protection.

Chaise pour usage intérieur et extérieur. Fabriquée en polypropylène avec fibre de verre, par technologie d'injection assistée par gaz. Protection UV.

Medidas | Measures | Mesures

W 50,9cm x L 53,5cm x H 82,5cm x Hs 46cm
W 20,04in x L 21,06in x H 32,48in x Hs 18,11in

Peso | Weight | Poids Apilado | Stackable | Empilable

3,65 kg 12 unidades | units | unités

Logística | Logistics | Logistique

	20'	40'	40 HC	70 m ³	100 m ³
2X	70	292	352	420	504
4X	288	584	728	840	928
P32	768	1536	1536	1728	1792

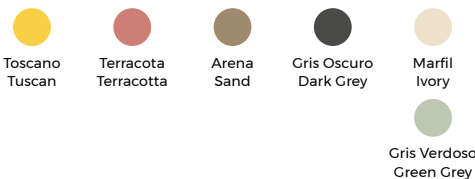

Como armchair

Designed by Joan Gaspar

NEW



Certificaciones | Certifications

NFEN581-1, UNEN16139, NFEN581-2

Silla con brazos para uso interior y exterior. Fabricada en polipropileno con fibra de vidrio mediante tecnología de moldeo asistida por gas. Protección UV.

Chair with arms for indoor and outdoor use. Manufactured in polypropylene with fibreglass using gas-assisted moulding technology. UV protection.

Chaise avec accoudoirs Como pour usage intérieur et extérieur. Fabriquée en polypropylène avec fibre de verre, par technologie d'injection assistée par gaz. Protection UV.

Medidas | Measures | Mesures

W 57,4cm x L 53,5cm x H 82,5cm x Hs 46cm x Ha 67,3cm
W 22,6in x L 21,06in x H 32,48in x Hs 18,11in x Ha 26,5in

Peso | Weight | Poids Apilado | Stackable | Empilable

4,01 kg 10 unidades | units | unités

Logística | Logistics | Logistique

	20'	40'	40 HC	70 m ³	100 m ³
2X	70	292	352	420	504
4X	252	516	600	696	784
P24	768	1536	1536	1728	1792

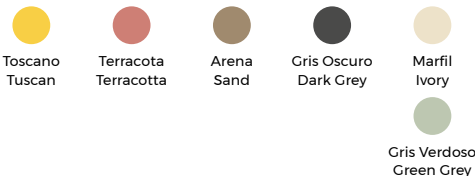

Sue

Designed by Joan Gaspar



Certificaciones | Certifications

NFEN581-1, NFEN581-2

Silla para uso interior y exterior. Inyectado en polipropileno con fibra de vidrio. Apilable. Protección UV.

Chair for indoor and outdoor use. Injected in polypropylene and fibreglass. Stackable. UV protection.

Chaise por usage intérieur et extérieur. Injectée en polupropylène avec fibre de verre. Emilable. Protection UV.

Medidas | Measures | Mesures

W 47,4cm x L 53cm x H 80cm x Hs 45,5cm
W 18,66in x L 20,87in x H 31,5in x Hs 17,91in

Peso | Weight | Poids Apilado | Stackable | Empilable

3,77 kg 8 unidades | units | unités

Logística | Logistics | Logistique

	20'	40'	40 HC	70 m ³	100 m ³
2X	108	240	240	492	392
4X	272	568	568	696	768
P26	624	1248	1248	1508	1664

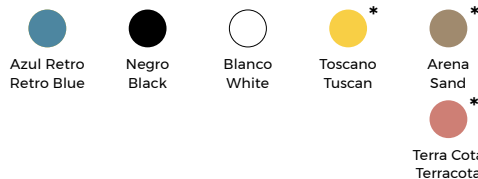

Sue armchair

Designed by Joan Gaspar



Silla para uso interior y exterior. Inyectado en polipropileno con fibra de vidrio. Apilable. Protección UV.

Chair for indoor and outdoor use. Injected in polypropylene and fiberglass. Stackable. UV protection.

Chaise pour usage intérieur et extérieur. Injectée en polopropylène avec fibre de verre. Emilable. Protection UV.

Medidas | Measures | Measures

W 54,5cm x L 53cm x H 80cm x Hs 45,5cm x Ha 66,8cm
W 21,46in x L 20,87in x H 31,5in x Hs 17,91in x Ha 26,3in

Peso | Weight | Poids Apilado | Stackable | Empilable

3,77 kg 7 unidades | units | unités

Logística | Logistics | Logistique

	20'	40'	40' HC	70 m ³	100 m ³
2X	108	306	240	416	392
4X	216	548	480	652	696
P20	480	960	960	1160	1280

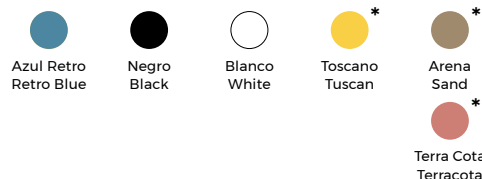

Certificaciones | Certifications

NFEN581-1, NFEN581-2

Ikona

Designed by Jorge Pensi



Silla con brazos para uso interior y exterior. Inyectado en polipropileno con fibra de vidrio. Apilable. Protección UV.

Armchair for indoor and outdoor use. Injected in polypropylene and fiberglass. Stackable. UV protection.

Fauteuil pour usage intérieur et extérieur. Injectée en polopropylène avec fibre de verre. Emilable. Protection UV.

Medidas | Measures | Measures

W 57,5cm x L 58cm x H 81,2cm x Hs 45cm x Ha 66cm
W 22,64in x L 22,83in x H 31,97in x Hs 17,72in x Ha 25,98in

Peso | Weight | Poids Apilado | Stackable | Empilable

3,9 kg 8 unidades | units | unités

Logística | Logistics | Logistique

	20'	40'	40' HC	70 m ³	100 m ³
2X	108	306	240	416	392
4X	216	548	480	652	696
P24	576	1152	1152	1296	1536

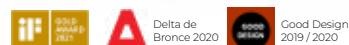

Certificaciones | Certifications

UNEN16139, UNEEN581-1

Tokyo

Designed by Josep Llusçà



Silla con brazos para uso interior y exterior. Fabricada en una sola pieza de polipropileno con fibra de vidrio 100% reciclado mediante tecnología de moldeo asistida por gas.

Armchair for indoor and outdoor use. Produced as a single piece of injected polypropylene 100% recycled with fiberglass using gas assisted injection moulding technology.

Fauteuil pour usage intérieur et extérieur. Produit en une seule pièce de polypropylène 100% recyclé injecté avec fibre de verre en utilisant technologie de moulage assistée par gaz.

Medidas | Measures | Measures

W 55,5cm x L 56,5cm x H 79,5cm x Hs 45cm x Ha 65,5cm
W 21,85in x L 22,24in x H 31,3in x Hs 17,72in x Ha 25,79in

Peso | Weight | Poids Apilado | Stackable | Empilable

4,1 kg 8 unidades | units | unités

Logística | Logistics | Logistique

	20'	40'	40' HC	70 m ³	100 m ³
2X	132	306	372	416	540
2X	132	306	372	416	540
P24	576	1152	1152	1296	1392



Tokyo

Designed by Josep Llusà



Silla con brazos para uso interior y exterior. Fabricada en una sola pieza de polipropileno con fibra de vidrio mediante tecnología de moldeo asistida por gas. Apilable.

Armchair for indoor and outdoor use. Produced as a single piece of injected polypropylene with fiberglass using gas assisted injection moulding technology. Stackable.

Fauteuil pour usage intérieur et extérieur. Produit en une seule pièce de polypropylène injecté avec fibre de verre en utilisant technologie de moulage assistée par gaz. Empilable.

Medidas | Measures | Mesures

W 55,5cm x L 56,5cm x H 79,5cm x Hs 45cm x Ha 65,5cm
W 21,85in x L 22,24in x H 31,3in x Hs 17,72in x Ha 25,79in

Peso | Weight | Poids Apilado | Stackable | Empilable

3,6 kg 8 unidades | units | unités

Logística | Logistics | Logistique

	20'	40'	40 HC	70 m ³	100 m ³
2X	132	306	372	416	540
4X	260	548	632	652	912
P24	576	1152	1152	1296	1392

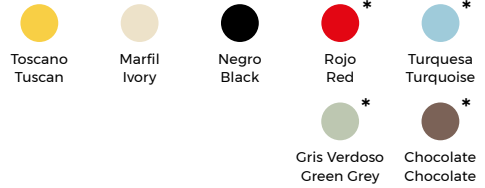

Certificaciones | Certifications

NFEN581-1,NFEN581-2,EN1728

Tokyo

Upholstered seat pad

Designed by Josep Llusà



Tapizado apto para interiores y exteriores. Composición Sunbrella®. Con espuma de secado rápido. Gramaje 275gr/m². Se ofrece la opción de tapizar solo el asiento. Para evitar marcas, por favor no apile las sillas tapizadas.

Upholstery suitable for indoor and outdoor use. Sunbrella® composition. With quick-drying foam. Grammage 275gr/m². The option of upholstering the seat only is available. To avoid marks, please do not stack upholstered chairs.

Tapisse adapte a l'intérieur et l'extérieur. Composition Sunbrella®. Avec mousse a sechage rapide. Grammage 275gr/m². Possibilite de ne tapisser que l'assise. Pour éviter les taches, veuillez ne pas empiler les chaises tapissées.

Medidas | Measures | Mesures

W 55,5cm x L 56,5cm x H 79,5cm x Hs 46cm x Ha 65,5cm
W 21,85in x L 22,24in x H 31,3in x Hs 18,11in x Ha 25,79in

Peso | Weight | Poids Apilado | Stackable | Empilable

4,6 kg 8 unidades | units | unités

	Structure	Negro Black	Toscano Tuscan	Marfil Ivory	Rojo Red*	Gris Verdoso Green Grey*	Turquesa Turquoise*	Chocolate Chocolate*
Upholstered								
Carbón Coal		•	•	•	•	•	•	•
Lino Linen		•		•	•	•	•	•
Negro Sunbrella Black Sunbrella		•	•	•	•	•	•	•
Taupe Taupe		•	•	•	•	•	•	•
Azul mineral Mineral Blue		•		•				•
Calabaza Pumpkin		•		•				•
Mimosa Mimosa		•	•	•				•

Certificaciones | Certifications

NFEN581-1,NFEN581-2,EN1728

Tapizado | Upholstered | Revêtement



Con espuma de secado rápido

With quick dry foam
Mousse à séchage rapide.

Tapizados aptos para interiores y exteriores

Upholstered suitable for indoor and outdoor
Revêtement apte pour intérieur et extérieur.

Gramaje | Grammage | Grammage

275 gr / m²

Para evitar marcas, por favor no apile las sillas tapizadas.

In order to avoid marks, please do not stack upholstered chairs.
Pour éviter des marques, ne pas empiler les chaises tapissées.

Logística | Logistics | Logistique

	20'	40'	40 HC	70 m ³	100 m ³
2X	132	306	372	416	540
4X	260	548	632	652	912

Splash

Designed by Jorge Pensi



Silla con brazos para uso interior y exterior. Asiento inyectado en polipropileno, con patas y brazos de tubo de aluminio anodizado. Protección UV.

Armchair for indoor and outdoor use. Seat injected with polypropylene. Arms and legs made in anodized aluminium. Stackable. UV protection.

Fauteuil d'intérieur et extérieur. Siège injecté en polypropylène. Pieds et accoudoirs en aluminium anodisé. Empilable. Protection UV.

Medidas | Measures | Mesures

W 57cm x L 54cm x H 79cm x Hs 45cm x Ha 68cm
W 22,44in x L 21,26in x H 31,1in x Hs 17,72in x Ha 26,77in

Peso | Weight | Poids Apilado | Stackable | Empilable

3,2 kg 5 unidades | units | unités

Logística | Logistics | Logistique



	20'	40'	40' HC	70 m ³	100 m ³
2X	138	304	304	436	562
4X	216	548	456	652	768

Certificaciones | Certifications

UNEN16139, UNEEN581-2, UNEEN581-1

Splash Aire

Designed by Jorge Pensi



Silla con brazos para uso interior y exterior. Fabricada en una sola pieza de polipropileno con fibra de vidrio mediante tecnología de moldeo asistida por gas. Apilable.

Armchair for indoor and outdoor use. Produced as a single piece of injected polypropylene with fiberglass using gas assisted injection moulding technology. Stackable.

Fauteuil pour usage intérieur et extérieur. Produit en une seule pièce de polypropylène injecté avec fibre de verre en utilisant technologie de moulage assistée par gaz. Empilable.

Medidas | Measures | Mesures

W 59,5cm x L 52,5cm x H 77cm x Hs 43cm x Ha 66,5cm
W 23,43in x L 20,67in x H 30,31in x Hs 16,93in x Ha 26,18in

Peso | Weight | Poids Apilado | Stackable | Empilable

3,95 kg 5 unidades | units | unités

Logística | Logistics | Logistique

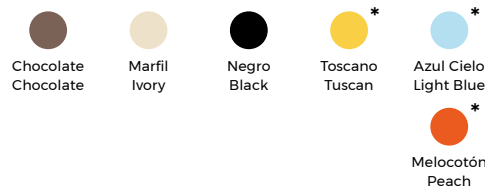

	20'	40'	40' HC	70 m ³	100 m ³
2X	132	306	372	416	540
4X	260	548	632	652	912
P17	272	640	640	736	864

Certificaciones | Certifications

UNEN16139, UNEEN581-2, UNEEN581-1

Woody

Designed by Josep Lluscà



Silla con brazos para uso interior y exterior. Inyectada en fibra de vidrio con PP 100% reciclada. Apilable. Protección UV.

Armchair for indoor and outdoor use. Injected with fiberglass and PP 100% recycled. UV protection.

Fauteuil d'intérieur et extérieur. Injecté avec fibre de verre et PP 100% recyclé.

Medidas | Measures | Mesures

W 59cm x L 56,5cm x H 74,2cm x Hs 45cm x Ha 67,2cm
W 23,23in x L 22,24in x H 29,21in x Hs 17,72in x Ha 26,46in

Peso | Weight | Poids Apilado | Stackable | Empilable

4,64 kg 10 unidades | units | unités

Logística | Logistics | Logistique

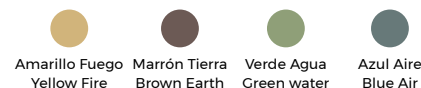

	20'	40'	40' HC	70 m ³	100 m ³
2X	132	306	372	416	540
4X	260	548	632	652	912
P25	600	1200	1200	1350	1450

Certificaciones | Certifications

UNEN16139, UNEEN581-2, UNEEN581-1

Woody

Designed by Josep Llusca

Silla con brazos para uso interior y exterior. Inyectada en fibra de vidrio con PP. Apilable. Protección UV.

Armchair for indoor and outdoor use. Injected with fiberglass and PP. Stackable. UV protection.

Fauteuil d'intérieur et extérieur. Injecté avec fibre de verre et PP. Empilable. Protection UV.



Medidas | Measures | Mesures

W 59cm x L 56,5cm x H 74,2cm x Hs 45cm x Ha 67,2cm
W 23,23in x L 22,24in x H 29,21in x Hs 17,72in x Ha 26,46in

Peso | Weight | Poids Apilado | Stackable | Empilable

4,2 kg 10 unidades | units | unités

Logística | Logistics | Logistique

	20'	40'	40 HC	70 m ³	100 m ³
2X	132	306	372	416	540
4X	260	548	632	652	912
P25	600	1200	1200	1350	1450



Certificaciones | Certifications

UNENI6139, UNEEN581-2, UNEEN581-1

Woody

Upholstered seat pad

Designed by Josep Llusca

Tapizado apto para interiores y exteriores. Composición Sunbrella®. Con espuma de secado rápido. Gramaje 275gr/m². Para evitar marcas, por favor no apile las sillas tapizadas.

Upholstery suitable for indoor and outdoor use. Sunbrella® composition. With quick-drying foam. Grammage 275gr/m². To avoid marks, please do not stack upholstered chairs.

Tapissé adapté à l'intérieur et l'extérieur. Composition Sunbrella®. Avec mousse à séchage rapide. Grammage 275gr/m². Pour éviter les taches, veuillez ne pas empiler les chaises tapissées.



Medidas | Measures | Mesures

W 59cm x L 56,5cm x H 74,2cm x Hs 46cm x Ha 67,2cm
W 23,23in x L 22,24in x H 29,21in x Hs 18,11in x Ha 26,46in

Peso | Weight | Poids

4,9 kg

Upholstered	Structure	Rojo Red	Arena Sand	Azul Retro Retro Blue	Marfil Ivory	Gris Verdoso Green Grey	Chocolate Chocolate	Gris Oscuro Dark Grey	Negro Black
		Carbón Coal	•		•				•
Lino Linen		•	•	•	•	•	•	•	•
Taupe Taupe			•		•	•	•		•
Calabaza Pumpkin			•		•		•	•	•

Certificaciones | Certifications

UNENI6139, UNEEN581-1, UNEEN581-2

Tapizado | Upholstered | Revêtement



Con espuma de secado rápido

With quick dry foam
Mousse à séchage rapide.

Tapizados aptos para interiores y exteriores

Upholstered suitable for indoor and outdoor
Revêtement apte pour intérieur et extérieur.

Gramaje | Grammage | Grammage

275 gr / m²

Para evitar marcas, por favor no apile las sillas tapizadas.

In order to avoid marks, please do not stack upholstered chairs.

Pour éviter des marques, ne pas empiler les chaises tapissées.

Logística | Logistics | Logistique

	20'	40'	40 HC	70 m ³	100 m ³
2X	132	306	372	416	540
4X	260	548	632	652	912

Steely

Designed by Josep Llusçà



Silla con brazos para uso interior y exterior. Inyectada en fibra de vidrio con PP 100% reciclado. Apilable. Protección UV. Peso Neto 4.7 kg

Armchair for indoor and outdoor use. Injected with fiberglass and PP 100% recycled. UV protection. Net weight 4,7 kg (10,32 lb).

Fauteuil d'intérieur et extérieur. Injecté avec fibre de verre et PP 100% recyclé. Protection UV. Poids net 4,7 kg.

Medidas | Measures | Mesures

W 59cm x L 56,5cm x H 74,2cm x Hs 45cm x Ha 67,2cm
W 23,23in x L 22,24in x H 29,21in x Hs 17,72in x Ha 26,46in

Peso | Weight | Poids Apilado | Stackable | Empilable

4,68 kg 10 unidades | units | unités

Logística | Logistics | Logistique

	20'	40'	40' HC	70 m ³	100 m ³
2X	132	306	372	416	540
4X	260	548	632	652	912
P25	600	1200	1200	1350	1450

Certificaciones | Certifications

UNEN16139, UNEEN581-2, UNEEN581-1



Steely

Designed by Josep Llusçà



Silla con brazos para uso interior y exterior. Inyectada en fibra de vidrio con PP. Apilable. Protección UV.

Armchair for indoor and outdoor use. Injected with fiberglass and PP. Stackable. UV protection.

Fauteuil d'intérieur et extérieur. Injecté avec fibre de verre et PP. Empilable. Protection UV.

Medidas | Measures | Mesures

W 59cm x L 56,5cm x H 74,2cm x Hs 45cm x Ha 67,2cm
W 23,23in x L 22,24in x H 29,21in x Hs 17,72in x Ha 26,46in

Peso | Weight | Poids Apilado | Stackable | Empilable

4,2 kg 10 unidades | units | unités

Logística | Logistics | Logistique

	20'	40'	40' HC	70 m ³	100 m ³
2X	132	306	372	416	540
4X	260	548	632	652	912
P25	600	1200	1200	1350	1450

Certificaciones | Certifications

UNEN16139, UNEEN581-2, UNEEN581-1



Steely

Upholstered seat pad

Designed by Josep Llusca



Certificaciones | Certifications

UNEEN581-1, UNEEN581-2

Tapizado | Upholstered | Revêtement



Con espuma de secado rápido

With quick dry foam

Mousse à séchage rapide.

Tapizados aptos para interiores y exteriores

Upholstered suitable for indoor and outdoor

Revêtement apte pour intérieur et extérieur.

Gramaje | Grammage | Grammage

275 gr / m2

Para evitar marcas, por favor no apile las sillas tapizadas.

In order to avoid marks, please do not stack upholstered chairs.

Pour éviter des marques, ne pas empiler les chaises tapissées.

Tapizado apto para interiores y exteriores. Composición Sunbrella®. Con espuma de secado rápido. Gramaje 275gr/m2. Para evitar marcas, por favor no apile las sillas tapizadas. Se ofrece la opción de tapizar solo el asiento.

Upholstery suitable for indoor and outdoor use. Sunbrella® composition. With quick-drying foam. Grammage 275gr/m2. To avoid marks, please do not stack upholstered chairs. The option of upholstering the seat only is available.

Tapissé adapté à l'intérieur et l'extérieur. Composition Sunbrella®. Avec mousse à séchage rapide. Grammage 275gr/m2. Pour éviter les taches, veuillez ne pas empiler les chaises tapissées. Possibilité de ne tapisser que l'assise.

Medidas | Measures | Mesures

W 59cm x L 56,5cm x H 74,2cm x Hs 46cm x Ha 67,2cm

W 23,23in x L 22,24in x H 29,21in x Hs 18,11in x Ha 26,46in

Peso | Weight | Poids

5,7 kg

Upholstered	Structure	●	●	●*	●*	●*	●*
		Marfil Ivory	Gris Oscuro Dark Grey	Arena Sand	Chocolate Chocolate	Azul Retro Retro Blue	Rojo Red
Carbón Coal			●			●	●
Lino Linen		●	●	●	●	●	●
Taupe Taupe		●		●	●		
Calabaza Pumpkin		●	●	●	●		

Logística | Logistics | Logistique

	20'	40'	40 HC	70 m ³	100 m ³
2X	132	306	372	416	540
4X	260	548	632	652	912

Toledo

Designed by Jorge Pensi



Silla con brazos para uso interior y exterior. Fabricada en aluminio fundido, pulido y anodizado, montado con tornillos de acero inoxidable. Apilable. 100% reciclable según los estándares internacionales de calidad de productos de bajas emisiones.

Armchair for indoor and outdoor use. Seat and back made of anodized and polished aluminum, mounted with stainless steel screws. Stackable. It's 100% recyclable according to International standards of low emission products.

Fauteuil pour usage intérieur et extérieur fabriqué en fonte d'aluminium anodisé et poli, assemblée avec des vis en acier inoxydable. Empilable. Il est également 100% recyclable selon les standards internationaux de qualité des produits de faibles émissions.

Medidas | Measures | Mesures

W 56,1cm x L 56,4cm x H 77,7cm x Hs 43,8cm x Ha 69cm

W 22,09in x L 22,2in x H 30,59in x Hs 17,24in x Ha 27,17in

Peso | Weight | Poids Apilado | Stackable | Empilable

6,8 kg

4 unidades | units | unités



Logística | Logistics | Logistique

	20'	40'	40 HC	70 m ³	100 m ³
2X	216	432	480	528	-



Certificaciones | Certifications

UNEN16139, UNEEN581-2, UNEEN581-1

Toledo Aire

Designed by Jorge Pensi



Green Edition



Delta de Plata 2018

Certificaciones | Certifications

UNEN16139, UNEEN581-2, UNEEN581-1

Silla con brazos para uso interior y exterior. Fabricada en una sola pieza de polipropileno reciclado con fibra de vidrio reciclada mediante tecnología de moldeo asistida por gas. Apilable.

Armchair for indoor and outdoor use. Produced as a single piece of injected polypropylene with fiberglass 100% recycled using gas assisted injection moulding technology.

Fauteuil pour usage intérieur et extérieur. Produit en une seule pièce de polypropylène 100% recyclé injecté avec fibre de verre en utilisant technologie de moulage assistée par gaz.

Medidas | Measures | Mesures

W 55cm x L 58,5cm x H 77,7cm x Hs 44,5cm x Ha 68,4cm
W 21,65in x L 23,03in x H 30,59in x Hs 17,52in x Ha 26,93in

Peso | Weight | Poids Apilado | Stackable | Empilable

3,9 kg 6 unidades | units | unités

Logística | Logistics | Logistique

	20'	40'	40' HC	70 m ³	100 m ³
2X	216	432	480	528	600
4X	260	548	632	652	912
P18	432	864	864	972	1044



Toledo Aire

Designed by Jorge Pensi



Delta de Plata 2018

Certificaciones | Certifications

UNEN16139, UNEEN581-2, UNEEN581-1

Silla con brazos para uso interior y exterior. Fabricada en una sola pieza de polipropileno con fibra de vidrio mediante tecnología de moldeo asistida por gas. Apilable.

Armchair for indoor and outdoor use. Produced as a single piece of injected polypropylene with fiberglass using gas assisted injection moulding technology. Stackable.

Fauteuil pour usage intérieur et extérieur. Produit en une seule pièce de polypropylène injecté avec fibre de verre en utilisant technologie de moulage assistée par gaz. Empilable.

Medidas | Measures | Mesures

W 55cm x L 58,5cm x H 77,7cm x Hs 44,5cm x Ha 68,4cm
W 21,65in x L 23,03in x H 30,59in x Hs 17,52in x Ha 26,93in

Peso | Weight | Poids Apilado | Stackable | Empilable

3,85 kg 6 unidades | units | unités

Logística | Logistics | Logistique

	20'	40'	40' HC	70 m ³	100 m ³
2X	216	432	480	528	600
4X	260	548	632	652	912
P18	432	864	864	972	1044

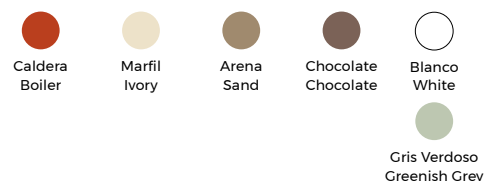

Casino

Designed by Joan Gaspar



Delta de Plata 2018

Certificaciones | Certifications

UNEN16139, UNEEN581-2, UNEEN581-1

Silla con brazos para uso interior y exterior. Inyectada en fibra de vidrio con PP mediante tecnología de moldeo asistida por gas. Apilable. Protección UV.

Armchair for indoor and outdoor use. Injected with fiberglass and PP using gas assisted injection moulding technology. Stackable. UV protection.

Fauteuil d'intérieur et extérieur. Injecté avec fibre de verre et PP, en utilisant technologie de moulage assistée par gaz. Empilable. Protection UV.

Medidas | Measures | Mesures

W 52,5cm x L 50cm x H 73,8cm x Hs 45,1cm x Ha 72cm
W 20,67in x L 19,69in x H 29,06in x Hs 17,76in x Ha 28,35in

Peso | Weight | Poids Apilado | Stackable | Empilable

3,5 kg 8 unidades | units | unités

Logística | Logistics | Logistique

	20'	40'	40' HC	70 m ³	100 m ³
2X	132	306	372	416	540
4X	264	612	744	832	1080
P25	600	1200	1200	1350	1550



Fiona

Designed by Josep Llusçà



Silla para uso interior y exterior. Inyectada con fibra de vidrio y PP. Apilable. Protección UV. Opcional: Pinza enlace de sillas para convenciones y eventos inyectada en policarbonato translúcido.

Chair for indoor and outdoor use. Injected with fiberglass and PP. Stackable. UV protection. Optional: Clamp connection of chairs for conventions and events injected in translucent polycarbonate.

Chaise pour usage intérieur et extérieur. Injectée avec fibre de verre et PP. Empilable. Protection UV. Optionnel: Pince de jonction des chaises pour conventions et événements injectée en polycarbonate translucide.

Medidas | Measures | Measures

W 48cm x L 54cm x H 80cm x Hs 47,5cm
W 18,9in x L 21,26in x H 31,5in x Hs 18,7in

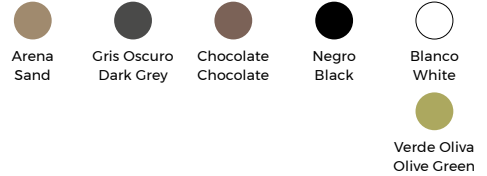

Peso | Weight | Poids Apilado | Stackable | Empilable

4,14 kg 10 unidades | units | unités

Logística | Logistics | Logistique

2X	138	306	304	416	562
4X	280	548	568	652	808
P24	576	1152	1152	1296	1392

Certificaciones | Certifications

UNEN16139

Fiona

Upholstered seat pad

Designed by Josep Llusçà



Silla para uso interior y exterior. Inyectada con fibra de vidrio y PP. Apilable. Protección UV. Opcional: Pinza enlace de sillas para convenciones y eventos inyectada en policarbonato translúcido.

Chair for indoor and outdoor use. Injected with fiberglass and PP. Stackable. UV protection. Optional: Clamp connection of chairs for conventions and events injected in translucent polycarbonate.

Chaise pour usage intérieur et extérieur. Injectée avec fibre de verre et PP. Empilable. Protection UV. Optionnel: Pince de jonction des chaises pour conventions et événements injectée en polycarbonate translucide.

Medidas | Measures | Measures

W 48cm x L 54cm x H 80cm x Hs 47,5cm
W 18,9in x L 21,26in x H 31,5in x Hs 18,7in

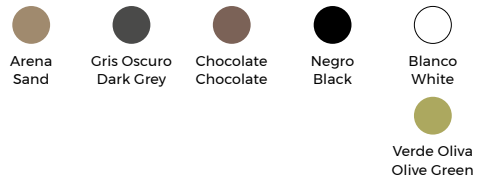

Peso | Weight | Poids

4,92 kg

Logística | Logistics | Logistique

4X	-	548	-	652	-

Certificaciones | Certifications

UNEN16139

Fiona conventions

Designed by Josep Llusçà



Silla para uso interior y exterior. Inyectada con fibra de vidrio y PP. Apilable. Protección UV. Opcional: Pinza enlace de sillas para convenciones y eventos inyectada en policarbonato translúcido.

Chair for indoor and outdoor use. Injected with fiberglass and PP. Stackable. UV protection. Optional: Clamp connection of chairs for conventions and events injected in translucent polycarbonate.

Chaise pour usage intérieur et extérieur. Injectée avec fibre de verre et PP. Empilable. Protection UV. Optionnel: Pince de jonction des chaises pour conventions et événements injectée en polycarbonate translucide.

Medidas | Measures | Measures

W 48cm x L 54cm x H 80cm x Hs 47,5cm
W 18,9in x L 21,26in x H 31,5in x Hs 18,7in

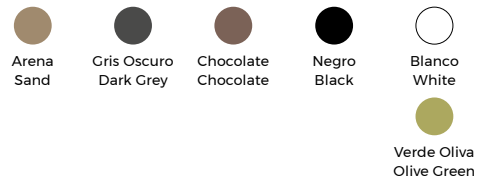

Peso | Weight | Poids

4,14 kg

Logística | Logistics | Logistique

4X	280	548	568	652	808
P14	576	1152	1152	1296	1392
P24	576	1152	1152	1296	1392

Certificaciones | Certifications

UNEN16139, UNEEN581-1, UNEEN581-2

resoles

* Sujeto a condiciones. Por favor, consultar.
* Subject to conditions. Please inquire.
* Sous réserve de conditions. Merci de consulter.

Fiona armchair

Designed by Josep Lluscà



Silla con brazos para uso interior y exterior. Inyectada con fibra de vidrio y PP. Apilable. Protección UV.

Armchair for indoor and outdoor use. Seat and back injected with fiberglass and PP. Stackable. UV protection.

Fauteuil pour usage intérieur et extérieur. Injecté avec fibre de verre et PP. Empilable. Protection UV.

Medidas | Measures | Measures

W 58cm x L 53cm x H 81cm x Hs 47,5cm x Ha 67,7cm
W 22,83in x L 20,87in x H 31,89in x Hs 18,7in x Ha 26,65in

Peso | Weight | Poids Apilado | Stackable | Empilable

4,98 kg 7 unidades | units | unités

Logística | Logistics | Logistique

	20'	40'	40 HC	70 m ³	100 m ³
2X	138	306	304	416	562
4X	216	548	456	652	768

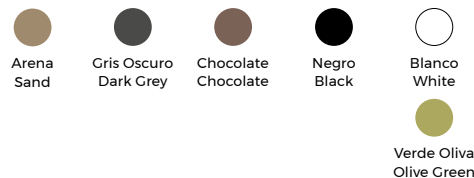

Certificaciones | Certifications

UNEN16139

Fiona armchair

Upholstered seat pad

Designed by Josep Lluscà



Silla con brazos para uso interior y exterior. Inyectada con fibra de vidrio y PP. Apilable. Protección UV.

Armchair for indoor and outdoor use. Seat and back injected with fiberglass and PP. Stackable. UV protection.

Fauteuil pour usage intérieur et extérieur. Injecté avec fibre de verre et PP. Empilable. Protection UV.

Medidas | Measures | Measures

W 58cm x L 53cm x H 81cm x Hs 47,5cm x Ha 67,7cm
W 22,83in x L 20,87in x H 31,89in x Hs 18,7in x Ha 26,65in

Peso | Weight | Poids

4,98 kg

Logística | Logistics | Logistique

	20'	40'	40 HC	70 m ³	100 m ³
4X	216	548	456	652	912



Certificaciones | Certifications

UNEN16139

New Fiona

Designed by Josep Lluscà



Silla con brazos para uso interior y exterior. Inyectada con fibra de vidrio y PP. Apilable. Protección UV.

Armchair for indoor and outdoor use. Seat and back injected with fiberglass and PP. Stackable. UV protection.

Fauteuil pour usage intérieur et extérieur. Injecté avec fibre de verre et PP. Empilable. Protection UV.

Medidas | Measures | Measures

W 52,3cm x L 52cm x H 80,5cm x Hs 46,1cm x Ha 67cm
W 20,59in x L 20,47in x H 31,69in x Hs 18,15in x Ha 26,38in

Peso | Weight | Poids Apilado | Stackable | Empilable

4,52 kg 10 unidades | units | unités

Logística | Logistics | Logistique

	20'	40'	40 HC	70 m ³	100 m ³
2X	138	306	304	416	562
4X	216	548	456	652	768
P20	480	960	960	1080	1160



Certificaciones | Certifications

UNEN16139, UNEEN581-1, UNEEN581-2

New Fiona

Upholstered seat pad

Designed by Josep Llusçà



Silla con brazos para uso interior y exterior. Inyectada con fibra de vidrio y PP. Apilable. Protección UV.

Armchair for indoor and outdoor use. Seat and back injected with fiberglass and PP. Stackable. UV protection.

Fauteuil pour usage intérieur et extérieur. Injecté avec fibre de verre et PP. Empilable. Protection UV.



Medidas | Measures | Measures

W 58cm x L 54cm x H 80cm x Hs 47,5cm x Ha 67,7cm

W 22,83in x L 21,26in x H 31,5in x Hs 18,7in x Ha 26,65in

Peso | Weight | Poids

5,22 kg

Logística | Logistics | Logistique

	20'	40'	40 HC	70 m³	100 m³
4X	-	548	-	652	-

Certificaciones | Certifications

UNEN16139, UNEEN581-1, UNEEN581-2

Fiona, Fiona armchair, & New Fiona

Upholstered seat pad

Designed by Josep Llusçà



Tejido vinílico espumado con soporte textil en poliéster algodón. Apto para mobiliario de interior con buena resistencia al desgaste por el roce, impermeable, durable y de fácil limpieza. Se recomienda lavar a mano con detergente neutro. Colores firmes y duraderos. Espumas de espesor 5 mm y presión de 18 kg. Para evitar marcas, por favor no apile las sillas tapizadas.

Foamed vinyl fabric with polyester-cotton textile frame. Suitable for indoor furniture with good resistance to wear and tear, waterproof, durable and easy to clean. Hand washing with neutral detergent is recommended. Strong and durable colours. 5 mm thick foams that withstand a pressure of 18 kg. To avoid marks, please do not stack upholstered chairs.

Tissu en vinyle et mousse avec support textile en polyester coton. Approprié pour les meubles d'intérieur avec une bonne résistance à l'abrasion, étanche à l'eau, durable et facile à nettoyer. Il est recommandé de laver à la main avec un détergent neutre. Couleurs solides et durables. Mousses de 5 mm d'épaisseur et pression de 18 kg. Pour éviter les taches, veuillez ne pas empiler les chaises tapissées.

Tapizado | Upholstered | Revêtement

SPRADLING®

Tapizados aptos para interiores y exteriores

Upholstered suitable for indoor and outdoor

Revêtement apte pour intérieur et extérieur.

Para evitar marcas, por favor no apile las sillas tapizadas.

In order to avoid marks, please do not stack upholstered chairs.

Pour éviter des marques, ne pas empiler les chaises tapissées.

	Structure	Verde Oliva Olive Green	Gris Oscuro Dark Grey	Blanco White	Chocolate Chocolate*	Negro Black*	Arena Sand*
Upholstered	Blanco White	•	•	•	•	•	•
Negro Black	•	•	•	•	•	•	•
Chocolate Chocolate	•	•	•	•	•	•	•
Arena Sand	•	•	•	•	•	•	•
Rojo Red	•	•	•	•	•	•	•
Nilo Nilo	•	•	•	•	•	•	•

Lama

Designed by Josep Llusçà



Silla para uso interior y exterior. Inyectada en fibra de vidrio con PP mediante tecnología de moldeado asistida por gas. Apilable. Protección UV. Opcional: Pinza enlace de sillas para convenciones y eventos inyectada en policarbonato translúcido.

Chair for indoor and outdoor use. Injected with fiberglass and PP using gas assisted injection moulding technology. Stackable. UV protection. Optional: Clamp connection of chairs for conventions and events injected in translucent polycarbonate

Chaise d'intérieur et extérieur. Injectée avec fibre de verre et PP, en utilisant technologie de moulage assistée par gaz. Empilable. Protection UV. Optionnel: Pince de jonction des chaises pour conventions et événements injectée en polycarbonate translucide.

Medidas | Measures | Mesures

W 48cm x L 54cm x H 80cm x Hs 47,5cm
W 18,9in x L 21,26in x H 31,5in x Hs 18,7in

Peso | Weight | Poids Apilado | Stackable | Empilable

4 kg 10 unidades | units | unités

Logística | Logistics | Logistique

	20'	40'	40' HC	70 m ³	100 m ³
2X	138	306	304	416	562
4X	280	548	568	652	808
P24	576	1152	1152	1296	1392



Certificaciones | Certifications

UNEEN581-1, UNEEN581-2

Lama armchair

Designed by Josep Llusçà



Silla con brazos para uso interior y exterior. Inyectada en fibra de vidrio con PP mediante tecnología de moldeado asistida por gas. Apilable. Protección UV.

Armchair for indoor and outdoor use. Injected with fiberglass and PP using gas assisted injection moulding technology. Stackable. UV protection.

Fauteuil d'intérieur et extérieur. Injecté avec fibre de verre et PP, en utilisant technologie de moulage assistée par gaz. Empilable. Protection UV.

Medidas | Measures | Mesures

W 58cm x L 54cm x H 81cm x Hs 47,5cm x Ha 67,7cm
W 22,83in x L 21,26in x H 31,89in x Hs 18,7in x Ha 26,65in

Peso | Weight | Poids Apilado | Stackable | Empilable

4,3 kg 7 unidades | units | unités

Logística | Logistics | Logistique

	20'	40'	40' HC	70 m ³	100 m ³
2X	138	306	304	416	562
4X	216	548	456	652	768
P20	480	960	960	1080	1160



Certificaciones | Certifications

UNEEN581-1

Trama

Designed by Josep Llusçà



Silla para uso interior y exterior. Inyectada en fibra de vidrio con PP mediante tecnología de moldeado asistida por gas. Apilable. Protección UV. Opcional: Pinza enlace de sillas para convenciones y eventos inyectada en policarbonato translúcido.

Chair for indoor and outdoor use. Injected with fiberglass and PP using gas assisted injection moulding technology. Stackable. UV protection. Optional: Clamp connection of chairs for conventions and events injected in translucent polycarbonate

Chaise d'intérieur et extérieur. Injectée avec fibre de verre et PP, en utilisant technologie de moulage assistée par gaz. Empilable. Protection contre les rayons UV. Optionnel: Pince de jonction des chaises pour conventions et événements injectée en polycarbonate translucide.

Medidas | Measures | Mesures

W 48cm x L 54cm x H 80cm x Hs 47,5cm
W 18,9in x L 21,26in x H 31,5in x Hs 18,7in

Peso | Weight | Poids Apilado | Stackable | Empilable

4 kg 10 unidades | units | unités

Logística | Logistics | Logistique

	20'	40'	40' HC	70 m ³	100 m ³
2X	138	306	304	416	562
4X	280	548	568	652	808
P24	576	1152	1152	1296	1392

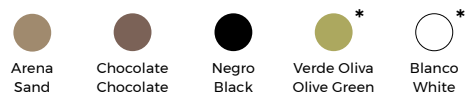

Certificaciones | Certifications

UNEEN581-1, UNEEN581-2

Trama armchair

Designed by Josep Llusçà



Silla con brazos para uso interior y exterior. Inyectada en fibra de vidrio con PP mediante tecnología de moldeo asistida por gas. Apilable. Protección UV.

Armchair for indoor and outdoor use. Injected with fiberglass and PP using gas assisted injection moulding technology. Stackable. UV protection.

Fauteuil d'intérieur et extérieur. Injecté avec fibre de verre et PP, en utilisant technologie de moulage assistée par gaz. Empilable. Protection UV.

Medidas | Measures | Mesures

W 57cm x L 54cm x H 80cm x Hs 47,5cm x Ha 66cm
W 22,44in x L 21,26in x H 31,5in x Hs 18,7in x Ha 25,98in

Peso | Weight | Poids Apilado | Stackable | Empilable

4,3 kg 7 unidades | units | unités

Logística | Logistics | Logistique

	20'	40'	40 HC	70 m ³	100 m ³
2X	138	306	304	416	562
4X	216	548	456	652	768
P20	480	960	960	1080	1160

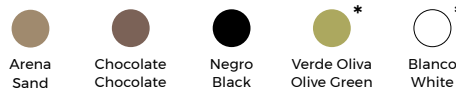

Certificaciones | Certifications

UNEEN581-1, UNEEN581-2

Beekat

Designed by Josep Llusçà



Silla para uso interior y exterior. Inyectada en fibra de vidrio con PP mediante tecnología de moldeo asistida por gas. Apilable. Protección UV.

Chair for indoor and outdoor use. Injected with fiberglass and PP using gas assisted injection moulding technology. UV protection. Stackable.

Chaise pour usage intérieur et extérieur. Injectée avec fibre de verre et PP, en utilisant technologie de moulage assistée par gaz. Empilable. Protection UV.

Medidas | Measures | Mesures

W 50,5cm x L 55,5cm x H 79cm x Hs 47cm
W 19,88in x L 21,85in x H 31,1in x Hs 18,5in

Peso | Weight | Poids Apilado | Stackable | Empilable

3,7 kg 10 unidades | units | unités

Logística | Logistics | Logistique

	20'	40'	40 HC	70 m ³	100 m ³
2X	138	306	304	416	562
4X	280	548	568	652	808
P23	552	1104	1104	1242	1334



Certificaciones | Certifications

UNEEN581-1

Beekat armchair

Designed by Josep Llusçà



Silla con brazos para uso interior y exterior. Inyectada en fibra de vidrio con PP mediante tecnología de moldeo asistida por gas. Apilable. Protección UV.

Armchair for indoor and outdoor use. Injected with fiberglass and PP using gas assisted injection moulding technology. Stackable. UV protection.

Fauteuil pour usage intérieur et extérieur. Injecté avec fibre de verre et PP, en utilisant technologie de moulage assistée par gaz. Empilable. Protection UV.

Medidas | Measures | Mesures

W 56cm x L 55,5cm x H 79cm x Hs 47cm x Ha 65,5cm
W 22,05in x L 21,85in x H 31,1in x Hs 18,5in x Ha 25,79in

Peso | Weight | Poids Apilado | Stackable | Empilable

4,2 kg 10 unidades | units | unités

Logística | Logistics | Logistique

	20'	40'	40 HC	70 m ³	100 m ³
2X	138	306	304	416	562
4X	216	548	456	652	768
P23	552	1104	1104	1242	1334



Certificaciones | Certifications

UNEEN581-1

Netkat

Designed by Josep Llusçà



IIDA Excellence IIDA/HD Product Design 2012

Certificaciones | Certifications

UNEEN581-1, UNEEN581-2

Silla para uso interior y exterior. Inyectada en fibra de vidrio con PP mediante tecnología de moldeo asistida por gas. Apilable. Protección UV.

Chair for indoor and outdoor use. Injected with fiberglass and PP using gas assisted injection moulding technology. Stackable. UV protection.

Chaise d'intérieur et extérieur. Injectée avec fibre de verre et PP, en utilisant technologie de moulage assistée par gaz. Empilable. Protection UV.

Medidas | Measures | Measures

W 50,5cm x L 55,5cm x H 79cm x Hs 47cm
W 19,88in x L 21,85in x H 31,1in x Hs 18,5in

Peso | Weight | Poids Apilado | Stackable | Empilable

3,6 kg 10 unidades | units | unités

Logística | Logistics | Logistique

	20'	40'	40' HC	70 m ³	100 m ³
2X	138	306	304	416	562
4X	280	548	568	652	808
P23	552	1104	1104	1242	1334



Netkat armchair

Designed by Josep Llusçà



IIDA Excellence IIDA/HD Product Design 2012

Certificaciones | Certifications

UNEEN581-1, UNEEN581-2

Silla con brazos para uso interior y exterior. Inyectada en fibra de vidrio con PP mediante tecnología de moldeo asistida por gas. Apilable. Protección UV.

Armchair for indoor and outdoor use. Injected with fiberglass and PP using gas assisted injection moulding technology. Stackable. UV protection.

Fauteuil d'intérieur et extérieur. Injecté avec fibre de verre et PP, en utilisant technologie de moulage assistée par gaz. Empilable. Protection UV.

Medidas | Measures | Measures

W 56cm x L 55,5cm x H 79cm x Hs 47cm x Ha 65,5cm
W 22,05in x L 21,85in x H 31,1in x Hs 18,5in x Ha 25,79in

Peso | Weight | Poids Apilado | Stackable | Empilable

4,1 kg 10 unidades | units | unités

Logística | Logistics | Logistique

	20'	40'	40' HC	70 m ³	100 m ³
2X	138	306	304	416	562
4X	216	548	456	652	768
P23	552	1104	1104	1242	1334



Gina

Designed by Joan Gaspar



Certificaciones | Certifications

UNEN16139, UNEEN581-1

Silla para uso interior y exterior. Inyectada en fibra de vidrio con PP mediante tecnología de moldeo asistida por gas. Apilable. Protección UV.

Chair for indoor and outdoor use. Injected with fiberglass and PP using gas assisted injection moulding technology. Stackable. UV protection.

Chaise d'intérieur et extérieur. Injectée avec fibre de verre et PP, en utilisant technologie de moulage assistée par gaz. Empilable. Protection UV.

Medidas | Measures | Measures

W 52,3cm x L 52cm x H 80,5cm x Hs 46,1cm
W 20,59in x L 20,47in x H 31,69in x Hs 18,15in

Peso | Weight | Poids Apilado | Stackable | Empilable

3,35 kg 10 unidades | units | unités

Logística | Logistics | Logistique

	20'	40'	40' HC	70 m ³	100 m ³
2X	132	306	372	416	540
4X	264	612	744	832	1080
P32	768	1536	1536	1728	1856



Gina armchair

Designed by Joan Gaspar



Certificaciones | Certifications

UNEN16139, UNEEN581-1

Silla con brazos para uso interior y exterior. Inyectada en fibra de vidrio con PP mediante tecnología de moldeo asistida por gas. Apilable. Protección UV. Tornillos inoxidables.

Armchair for indoor and outdoor use. Injected with fiberglass and PP using gas assisted injection moulding technology. Stackable. UV protection. Stainless steel screws.

Fauteuil d'intérieur et extérieur. Injecté avec fibre de verre et PP, en utilisant technologie de moulage assistée par gaz. Empilable. Protection UV. Vis en acier inoxydable.

Medidas | Measures | Mesures

W 56,9cm x L 52cm x H 80,5cm x Hs 46,1cm x Ha 66,5cm
W 22,4in x L 20,47in x H 31,69in x Hs 18,15in x Ha 26,18in

Peso | Weight | Poids Apilado | Stackable | Empilable

3,65 kg 7 unidades | units | unités

Logística | Logistics | Logistique

	20'	40'	40 HC	70 m ³	100 m ³
2X	138	306	304	416	562
4X	176	612	744	832	768
P24	264	600	600	792	912



Rojo Red



Verde Oliva Olive Green



Arena Sand



Chocolate Chocolate



Blanco White

Lisboa

Designed by Joan Gaspar



Certificaciones | Certifications

UNEN16139, UNEEN581-2, UNEEN581-1

Silla para uso interior y exterior. Inyectada en fibra de vidrio con PP mediante tecnología de moldeo asistida por gas. Apilable. Protección UV.

Chair for indoor and outdoor use. Injected with fiberglass and PP using gas assisted injection moulding technology. Stackable. UV protection.

Chaise d'intérieur et extérieur. Injectée avec fibre de verre et PP, en utilisant technologie de moulage assistée par gaz. Empilable. Protection UV.

Medidas | Measures | Mesures

W 47cm x L 51cm x H 82cm x Hs 46cm
W 18,5in x L 20,08in x H 32,28in x Hs 18,11in

Peso | Weight | Poids Apilado | Stackable | Empilable

3,36 kg 10 unidades | units | unités

Logística | Logistics | Logistique

	20'	40'	40 HC	70 m ³	100 m ³
2X	138	306	304	416	562
4X	216	456	456	552	768
P24	576	1152	1152	1296	1392



Gris Oscuro Dark Grey



Chocolate Chocolate



Arena Sand



Negro Black *



Blanco White *



Rojo Red



Verde Oliva Olive Green



Burdeos Burgundy *



Azul Retro Retro Blue *

Lisboa armchair

Designed by Joan Gaspar



Certificaciones | Certifications

UNEN16139, UNEEN581-2, UNEEN581-1

Silla con brazos para uso interior y exterior. Inyectada en fibra de vidrio con PP mediante tecnología de moldeo asistida por gas. Brazos sujetos a la estructura mediante tornillos inoxidables. Apilable. Protección UV.

Armchair for indoor and outdoor use. Injected with fiberglass and PP using gas assisted injection moulding technology. Armrests fixed to the structure with steel screws. Stackable. UV protection.

Fauteuil d'intérieur et extérieur. Injecté avec fibre de verre et PP, en utilisant technologie de moulage assistée par gaz. Accoudoirs fixé à la structure avec des vis en acier inoxydable. Empilable. Protection UV.

Medidas | Measures | Mesures

W 58cm x L 51cm x H 82cm x Hs 46cm x Ha 70cm
W 22,83in x L 20,08in x H 32,28in x Hs 18,11in x Ha 27,56in

Peso | Weight | Poids Apilado | Stackable | Empilable

3,67 kg 7 unidades | units | unités

Logística | Logistics | Logistique

	20'	40'	40 HC	70 m ³	100 m ³
2X	138	306	304	416	562
4X	216	456	456	552	768
P23	552	1104	1104	1242	1334



Gris Oscuro Dark Grey



Chocolate Chocolate



Arena Sand



Negro Black *



Blanco White *



Rojo Red



Verde Oliva Olive Green



Burdeos Burgundy *



Azul Retro Retro Blue *



Lisboa

Upholstered seat pad

Designed by Joan Gaspar



Silla con asiento tapizado con tejido vinílico Spradling. Apto para mobiliario de interior con buena resistencia al desgaste por el roce, impermeable, durable y de fácil limpieza. Se recomienda lavar a mano con detergente neutro. Colores firmes y duraderos. Espumas de espesor 5 mm y presión de 18 kg.

Chair with seat pad upholstered with Spradling vinyl fabric. Suitable for indoor with good resistance to friction, waterproof, durable, and easy to clean. Recommended to be hand washed with mild detergent. Firm and lasting colours. Foam of 5 mm thick with pressure of 18 kg.

Chaise avec siège tapissé avec tissu en vinyle Spradling. Appropriate pour les meubles d'intérieur avec une bonne résistance à l'abrasion, étanche à l'eau, durable et facile à nettoyer. Il est recommandé de laver à la main avec un détergent neutre. Couleurs solides et durables. Mousse de 5 mm d'épaisseur et pression de 18 kg.

Medidas | Measures | Mesures

W 47cm x L 51cm x H 82cm x Hs 47,5cm
W 18,5in x L 20,08in x H 32,28in x Hs 18,7in

Peso | Weight | Poids

4,06 kg

Logística | Logistics | Logistique



Certificaciones | Certifications

UNEN16139, UNEEN581-2, UNEEN581-1

	4X	216	456	456	552	0

Lisboa armchair

Upholstered seat pad

Designed by Joan Gaspar



Silla con asiento tapizado con tejido vinílico Spradling. Apto para mobiliario de interior con buena resistencia al desgaste por el roce, impermeable, durable y de fácil limpieza. Se recomienda lavar a mano con detergente neutro. Colores firmes y duraderos. Espumas de espesor 5 mm y presión de 18 kg.

Chair with seat pad upholstered with Spradling vinyl fabric. Suitable for indoor with good resistance to friction, waterproof, durable, and easy to clean. Recommended to be hand washed with mild detergent. Firm and lasting colours. Foam of 5 mm thick with pressure of 18 kg.

Chaise avec siège tapissé avec tissu en vinyle Spradling. Appropriate pour les meubles d'intérieur avec une bonne résistance à l'abrasion, étanche à l'eau, durable et facile à nettoyer. Il est recommandé de laver à la main avec un détergent neutre. Couleurs solides et durables. Mousse de 5 mm d'épaisseur et pression de 18 kg.

Medidas | Measures | Mesures

W 58cm x L 51cm x H 82cm x Hs 47cm x Ha 70cm
W 22,83in x L 20,08in x H 32,28in x Hs 18,5in x Ha 27,56in

Peso | Weight | Poids

4,37 kg

Certificaciones | Certifications

UNEN16139, UNEEN581-2, UNEEN581-1

	Structure	Gris Oscuro Dark Grey	Chocolate Chocolate	Arena Sand	Negro Black	Blanco White	Rojo Red	Verde Oliva Olive Green	Burdeos [*] Burgundy	Azul Retro [*] Retro Blue
Upholstered										
Blanco White		•	•	•	•	•	•	•	•	•
Negro Black		•	•	•	•	•	•	•	•	•
Chocolate Chocolate		•	•	•	•	•	•	•	•	•
Arena Sand		•	•	•	•	•	•	•	•	•
Rojo Red		•	•	•	•	•	•	•	•	•
Nilo Nilo		•	•	•	•	•	•	•	•	•

Tapizado | Upholstered | Revêtement

SPRADLING®

Tapizados aptos para interiores y exteriores
Upholstered suitable for indoor and outdoor
Revêtement apte pour intérieur et extérieur.

Para evitar marcas, por favor no apile las sillas tapizadas.

In order to avoid marks, please do not stack upholstered chairs.

Pour éviter des marques, ne pas empiler les chaises tapissées.

Logística | Logistics | Logistique

	4X	260	456	456	552	808

Peach

Designed by Joan Gaspar



Silla con brazos para uso interior y exterior. Inyectada en fibra de vidrio con PP mediante tecnología de moldeo asistida por gas. Apilable. Protección UV.

Armchair for indoor and outdoor use. Injected with fiberglass and PP using gas assisted injection moulding technology. Stackable. UV protection.

Fauteuil d'intérieur et extérieur. Injecté avec fibre de verre et PP, en utilisant technologie de moulage assistée par gaz. Empilable. Protection UV.

Medidas | Measures | Measures

W 55,9cm x L 48cm x H 74,5cm x Hs 44,4cm x Ha 63,9cm
W 22,01in x L 18,9in x H 29,33in x Hs 17,48in x Ha 25,16in

Peso | Weight | Poids Apilado | Stackable | Empilable

4,2 kg 8 unidades | units | unités

Logística | Logistics | Logistique

	20'	40'	40' HC	70 m ³	100 m ³
2X	138	306	304	416	562
4X	216	548	456	652	768
P24	576	1152	1152	1296	1392

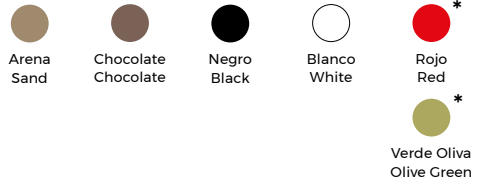

IIDA

Excellence IIDA/HD Product Design 2012

Certificaciones | Certifications

UNEEN581-1, UNEEN581-2

Peach

Upholstered seat pad

Designed by Joan Gaspar



Silla con asiento tapizado con tejido vinílico Spradling. Apto para mobiliario de interior con buena resistencia al desgaste por el roce, impermeable, durable y de fácil limpieza. Se recomienda lavar a mano con detergente neutro. Colores firmes y duraderos. Espumas de espesor 5 mm y presión de 18 kg.

Chair with seat pad upholstered with Spradling vinyl fabric. Suitable for indoor with good resistance to friction, waterproof, durable, and easy to clean. Recommended to be hand washed with mild detergent. Firm and lasting colours. Foam of 5 mm thick with pressure of 18 kg.

Chaise avec siège tapissé avec tissu en vinyle Spradling. Appropriate pour les meubles d'intérieur avec une bonne résistance à l'abrasion, étanche à l'eau, durable et facile à nettoyer. Il est recommandé de laver à la main avec un détergent neutre. Couleurs solides et durables. Mousse de 5 mm d'épaisseur et pression de 18 kg.

Medidas | Measures | Measures

W 55,9cm x L 48cm x H 74,5cm x Hs 44,5cm x Ha 64,5cm
W 22,01in x L 18,9in x H 29,33in x Hs 17,52in x Ha 25,39in

Peso | Weight | Poids

4,95 kg

Certificaciones | Certifications

UNEEN581-1, UNEEN581-2

Tapizado | Upholstered | Revêtement

SPRADLING®

Tapizados aptos para interiores y exteriores

Upholstered suitable for indoor and outdoor

Revêtement apte pour intérieur et extérieur.

Para evitar marcas, por favor no apile las sillas tapizadas.

In order to avoid marks, please do not stack upholstered chairs.

Pour éviter des marques, ne pas empiler les chaises tapissées.

Logística | Logistics | Logistique

	20'	40'	40' HC	70 m ³	100 m ³
4X	260	548	632	652	912

Upholstered	Structure	Arena Sand	Chocolate Chocolate	Negro Black	Blanco White	Rojo Red*	Verde Oliva Olive Green*
		Blanco White	•	•	•	•	•
Negro Black		•	•	•	•	•	•
Chocolate Chocolate		•	•	•	•	•	•
Arena Sand		•	•	•	•	•	•
Rojo Red		•	•	•	•	•	•
Nilo Nilo		•	•	•	•	•	•

Carla

Designed by Fabrizio Batoni

Silla para uso interior y exterior. Inyectada con fibra de vidrio y PP. Apilable. Protección contra rayos UV.

Chair for indoor and outdoor use, injected with fiberglass and PP. Stackable. UV protection.

Chaise d'intérieur et extérieur. Injectée avec fibre de verre et PP. Empilable. Protection contre les rayons UV.



Medidas | Measures | Mesures

W 56,5cm x L 55,7cm x H 78,7cm x Hs 45cm
W 22,24in x L 21,93in x H 30,98in x Hs 17,72in



Peso | Weight | Poids Apilado | Stackable | Empilable

4 kg 5 unidades | units | unités

Logística | Logistics | Logistique

	20'	40'	40' HC	70 m ³	100 m ³
2X	138	306	304	416	562
4X	320	640	640	736	832
P14	308	616	616	700	840

Certificaciones | Certifications

UNENI6139, UNEEN581-1

Spot

Designed by Josep Llusçà



Silla para uso interior y exterior. Inyectada en fibra de vidrio con PP 100% reciclado mediante tecnología de moldeo asistida por gas. Apilable. Protección contra rayos UV.

Chair for indoor and outdoor use. Injected in fiber glass with PP 100% recycled using gas assisted injection moulding technology. UV Protection.

Chaise d'intérieur et extérieur. Injectée avec fibre de verre et PP 100% recyclé, en utilisant technologie de moulage assistée par gaz. Protection UV.



Medidas | Measures | Mesures

W 45cm x L 54cm x H 78cm x Hs 45cm
W 17,72in x L 21,26in x H 30,71in x Hs 17,72in

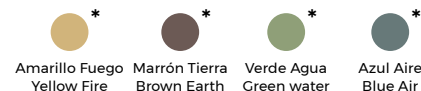

Peso | Weight | Poids Apilado | Stackable | Empilable

3,42 kg 10 unidades | units | unités

Logística | Logistics | Logistique

	20'	40'	40' HC	70 m ³	100 m ³
2X	138	306	304	416	562
4X	280	548	568	652	808
P22	528	1056	1056	1188	1276

Certificaciones | Certifications

UNEEN581-1

Spot

Designed by Josep Llusçà

Silla para uso interior y exterior. Inyectada en fibra de vidrio con PP mediante tecnología de moldeo asistida por gas. Apilable. Protección contra rayos UV.

Chair for indoor and outdoor use. Injected in fiberglass with PP using gas assisted injection moulding technology. Stackable. UV Protection.

Chaise d'intérieur et extérieur. Injectée avec fibre de verre et PP, en utilisant technologie de moulage assistée par gaz. Empilable. Protection UV.



Medidas | Measures | Mesures

W 45cm x L 54cm x H 78cm x Hs 45cm
W 17,72in x L 21,26in x H 30,71in x Hs 17,72in

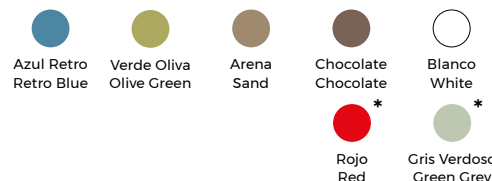

Peso | Weight | Poids Apilado | Stackable | Empilable

2,8 kg 10 unidades | units | unités

Logística | Logistics | Logistique

	20'	40'	40' HC	70 m ³	100 m ³
2X	138	306	304	416	562
4X	280	548	568	652	808
P22	528	1056	1056	1188	1276

Certificaciones | Certifications

NFEN581-1, NFEN581-2

Neutra

Designed by Joan Gaspar



Silla para uso interior y exterior. Inyectada en fibra de vidrio con PP mediante tecnología de moldeo asistida por gas. Apilable. Protección UV.

Chair for indoor and outdoor use. Injected with fiberglass and PP using gas assisted injection moulding technology. Stackable. UV protection.

Chaise d'intérieur et extérieur. Injectée avec fibre de verre et PP, en utilisant technologie de moulage assistée par gaz. Empilable. Protection UV.

Medidas | Measures | Measures

W 47cm x L 48cm x H 78cm x Hs 46cm
W 18,5in x L 18,9in x H 30,7in x Hs 18,1in



Peso | Weight | Poids Apilado | Stackable | Empilable

3,2 kg 10 unidades | units | unités

Logística | Logistics | Logistique

	20'	40'	40 HC	70 m ³	100 m ³
2X	138	306	304	416	562
4X	280	568	568	632	808
P29	696	1392	1392	1566	1682

Certificaciones | Certifications

UNEEN581-2,UNEEN581-1,UNEN16139

Neutra

Upholstered seat pad

Designed by Joan Gaspar



Silla con asiento tapizado con tejido vinílico Spradling. Apto para mobiliario de interior con buena resistencia al desgaste por el roce, impermeable, durable y de fácil limpieza. Se recomienda lavar a mano con detergente neutro. Colores firmes y duraderos. Espumas de espesor 5 mm y presión de 18 kg.

Chair with seat pad upholstered with Spradling vinyl fabric. Suitable for indoor with good resistance to friction, waterproof, durable, and easy to clean. Recommended to be hand washed with mild detergent. Firm and lasting colours. Foam of 5 mm thick with pressure of 18 kg.

Chaise avec siège tapissé avec tissu en vinyle Spradling. Appropriate pour les meubles d'intérieur avec une bonne résistance à l'abrasion, étanche à l'eau, durable et facile à nettoyer. Il est recommandé de laver à la main avec un détergent neutre. Couleurs solides et durables. Mousse de 5 mm d'épaisseur et pression de 18 kg.

Medidas | Measures | Measures

W 47cm x L 48cm x H 78cm x Hs 47cm
W 18,5in x L 18,9in x H 30,7in x Hs 18,5in

Peso | Weight | Poids

3,9 kg

Certificaciones | Certifications

UNEEN581-2,UNEEN581-1,UNEN16139

Tapizado | Upholstered | Revêtement

SPRADLING®

Tapizados aptos para interiores y exteriores
Upholstered suitable for indoor and outdoor
Revêtement apte pour intérieur et extérieur.

Para evitar marcas, por favor no apile las sillas tapizadas.

In order to avoid marks, please do not stack upholstered chairs.

Pour éviter des marques, ne pas empiler les chaises tapissées.

Logística | Logistics | Logistique

	20'	40'	40 HC	70 m ³	100 m ³
4X	312	624	768	748	996

Upholstered	Structure	Verde Oliva Olive Green	Rojo Red	Arena Sand	Blanco White	Chocolate Chocolate*
		Blanco White	•	•	•	•
Negro Black		•	•	•	•	•
Chocolate Chocolate		•	•	•	•	•
Arena Sand		•	•	•	•	•
Rojo Red		•	•	•	•	•
Nilo Nilo		•	•	•	•	•

* Sujeto a condiciones. Por favor, consultar.
* Subject to conditions. Please inquire.
* Sous réserve de conditions. Merci de consulter.

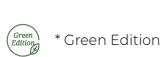

Mesas

Tables / Tables



Anthea Dining Table

Designed by Monica Armani



Mesa de comedor con estructura en aluminio de fundición y extrusión. Top en compacto. Amplia gama cromática y combinaciones. Apta para exterior.

Dining table with structure in cast and extruded aluminium, compact top and tempered glass. Suitable for outdoors.

Table à manger avec structure en fonte d'aluminium et extrusion, et plateau en compact et verre trempé. Utilisable à l'extérieur.

Medidas | Measures | Mesures

W 209,5cm x L 80,5cm x H 73cm
W 82,48in x L 31,69in x H 28,74in

Peso | Weight | Poids

51,9 kg

Logística | Logistics | Logistique

1X	33	72	85	-	85

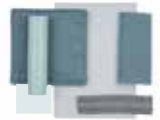

Ver combinaciones de colores en página 447.
See color combinations on page 447.

Espiga

Designed by Jordi Ribaudí



Mesa con perfiles de aluminio pintados. Sobre de fenólico efecto relieve en impresión digital. Tacos antideslizantes. Tornillería de acero inoxidable.

Table with painted aluminium profiles. Top made of phenolic with embossing effect in digital printing. Anti-slip feet. Screws made of stainless steel.

Table aux profils en aluminium peints. Dessus en phénolique, effet relief par impression digitale. Visserie en acier inoxydable.

Medidas | Measures | Mesures

W 90cm	W 35,43in	W 100cm	W 39,37in
L 160cm	L 62,99in	L 220cm	L 86,61in
H 75,5cm	H 29,72in	H 75,5cm	H 29,72in

Peso | Weight | Poids

25 - 30 kg

Logística | Logistics | Logistique

1X	113	226	249	272	-



Dom

Designed by Joan Casas



Mesa con estructura de perfil de aluminio anodizado. Sobre HPL. Tacos antideslizantes. Tornillería de acero inoxidable. Disponible en varias medidas.

Table with anodised aluminium profile frame. HPL Top. Anti-slip pads. Stainless steel fasteners. Available in various sizes.

Table avec structure en profilé massif d'aluminium anodisé. Plateau HPL. Patins antidérapants. Visserie en acier inoxydable. Disponible en plusieurs mesures.

Medidas | Measures | Mesures

W 70cm	W 27,56in	W 80cm	W 31,49in	W 90cm	W 35,43in
L 70cm	L 27,56in	L 80cm	L 31,49in	L 90cm	L 35,43in
H 74cm	H 29,13in	H 74cm	H 29,13in	H 74cm	H 29,13in
W 100cm	W 39,37in	W 120cm	W 47,24in	W 180cm	W 70,86in
L 100cm	L 39,37in	L 80cm	L 31,49in	L 90cm	L 5,43in
H 74cm	H 29,13in	H 74cm	H 29,13in	H 74cm	H 29,13in

Peso | Weight | Poids

20,68 - 22,14 - 24 - 27 - 27 - 34,76 kg

Logística | Logistics | Logistique

1X	643	1286	1415	1543	-



Domino

Designed by Joan Casas

Mesa de perfil de aluminio anodizado. Sobre HPL. Tacos antiderrapantes. Tornillería de acero inoxidable. Disponible en varias medidas

Anodised aluminium profile table. HPL Top. Anti-slip pads. Stainless steel fasteners. Available in various sizes

Table en profilé massif d'aluminium anodisé. Plateau HPL. Patins antidérapants. Visserie en acier inoxydable. Disponible en plusieurs mesures.



Medidas | Measures | Mesures

W 90cm	W 35,43in	W 100cm	W 39,37in
L 90cm	L 35,43in	L 100cm	L 39,37in
H 74cm	H 29,13in	H 74cm	H 29,13in
W 100cm	W 39,37in	W 100cm	W 39,37in
L 200cm	L 78,74in	L 240cm	L 94,48in
H 74cm	H 29,13in	H 74cm	H 29,13in



Peso | Weight | Poids

24 - 27 - 41 - 46 kg

Logística | Logistics | Logistique

1X	394	788	866	945	-

Milano

Designed by Joan Gaspar

Mesa redonda Ø1350 para uso interior y exterior. Estructura de aluminio anodizado pintado por pulverización y secado al horno.

Round table for indoor and outdoor use. Powder coated anodized aluminium structure.

Table ronde pour une utilisation à l'intérieur et à l'extérieur. Structure en aluminium anodisé peinte au pistolet et séchée au four.



Medidas | Measures | Mesures

Ø 1350cm x H 74cm
Ø 531,5in x H 29,13in



Peso | Weight | Poids

26 kg

Logística | Logistics | Logistique

1X	81	164	172	212	284

Milano

Designed by Joan Gaspar

Mesa rectangular 180x90 para uso interior y exterior. Estructura de aluminio anodizado pintado por pulverización y secado al horno, de 40 x 40 mm y 2 mm de grosor. Sobre 3 mm de grosor.

Rectangular 180x90 table for indoor and outdoor use. Anodised aluminium structure, spray painted and oven dried, 40 x 40 mm and 2 mm thick. About 3 mm thick.

Table rectangulaire 180x90 pour usage intérieur et extérieur. Structure en aluminium anodisé peint par pulvérisation et séché au four de 40 x 40 mm et de 2 mm d'épaisseur. Sur 3 mm d'épaisseur.



Medidas | Measures | Mesures

W 90cm x L 180cm x H 73,4cm
W 35,43in x L 70,87in x H 28,90in



Peso | Weight | Poids

24 kg

Logística | Logistics | Logistique

1X	130	264	264	300	-

Barcino

square

Designed by Joan Gaspar



Mesa apilable para uso interior y exterior. Estructura de aluminio anodizado pintado por pulverización y secado al horno de 40 x 40 mm y 1,50 mm de grosor. Sobre de 3 mm de grosor.

Table for indoor and outdoor use. Powder coated anodized aluminium frame and oven-drying 40 x 40 mm and 1,50 mm thick. Table top of 3 mm thickness.

Table pour usage intérieur et extérieur. Structure en aluminium anodisé peinte par pulvérisation et séchée au four 40 x 40 mm et 1,50 mm de grosseur. Plateau de 3 mm de grosseur.

Medidas | Measures | Measures

W 70cm	W 31,49in	W 90cm	W 35,43in
L 70cm	L 31,49in	L 90cm	L 35,43in
H 74cm	H 29,13in	H 74cm	H 29,13in



Peso | Weight | Poids Apilado | Stackable | Empilable

7,9 - 11,2 kg 10 unidades | units | unités

Logística | Logistics | Logistique

	20'	40'	40 HC	70 m ³	100 m ³
1X	200	480	480	520	600
P20	200	480	480	520	600

Certificaciones | Certifications

UNEEN581-1

Barcino Compact

square

Designed by Joan Gaspar



Mesa apilable para uso interior y exterior. Estructura de aluminio anodizado pintado por pulverización y secado al horno de 40 x 40 mm y 1,50 mm de grosor. Tablero de compacto fenólico de 10 mm de grosor.

Stackable table for indoor and outdoor use. Powder coated anodized aluminium frame and oven-drying 40 x 40 mm and 1,50 mm thick. Table top of HPL of 10 mm thickness.

Table empilable pour usage intérieur et extérieur. Structure en aluminium anodisé peinte par pulvérisation et séchée au four 40 x 40 mm et 1,50 mm de grosseur. Plateau en résine phénolique de 10 mm de grosseur.

Medidas | Measures | Measures

W 70cm x L 70cm x H 74cm
W 27,56in x L 27,56in x H 29,13in



Peso | Weight | Poids Apilado | Stackable

10,68 kg 10 unidades | units

Logística | Logistics | Logistique

	20'	40'	40 HC	70 m ³	100 m ³
1X	180	432	432	468	540

Certificaciones | Certifications

UNEEN581-1

Noren

Designed by David Carrasco Barceló



Mesa para uso interior y exterior con pie central compuesto por dos bases inyectadas en fibra de vidrio con PP mediante tecnología de moldeo asistida por gas, unidas por una barra de aluminio. Protección UV. Sobre de cristal.

Table for indoor and outdoor use with a central foot made up of two bases injected with fibreglass and PP by means of gas-assisted moulding technology, joined by an aluminium bar. UV protection. Glass tabletop.

Table pour usage intérieur et extérieur avec pied central composé de deux bases injectées en fibre de verre avec PP à l'aide de la technologie de moulage assisté par gaz, reliées par une barre d'aluminium. Protection UV. Plateau en verre.

Medidas | Measures | Measures

Ø 100cm	Ø 29,13in	W 100cm	W 29,13in	W 100cm	W 29,13in
H 74cm	H 27,56in	L 160cm	L 62,99in	L 200cm	L 78,74in
		H 74cm	H 27,56in	H 74cm	H 27,56in



Peso | Weight | Poids

18,67 - 46,21 - 50,61 - 54,61 kg

Logística | Logistics | Logistique

	20'	40'	40 HC	70 m ³	100 m ³
1X	167	344	370	500	523

* Sujeto a condiciones. Por favor, consultar.
* Subject to conditions. Please inquire.
* Sous réserve de conditions. Merci de consulter.

Corner

Mesa Corner con sobre de compacto fenólico y 3/4 patas inyectadas en polipropileno con fibra de vidrio mediante tecnología de moldeo asistida por gas. Protección UV. Apilable.

Corner table with an HPL table top, 3 or 4 legs, depending on the size and shape, injected in polypropylene with fiberglass. UV protection. Stackable.

Table Corner avec plateau en HPL, 3 ou 4 pieds, selon la taille et la forme, injecté en polypropylène avec fibre de verre. Protection UV. Empilable.



Medidas | Measures | Mesures

Ø 60cm H 73,5cm	Ø 23,62in H 28,94in	Ø 70cm H 73,5cm	Ø 31,49in H 28,94in	Ø 80cm H 73,5cm	Ø 31,49in H 28,94in	Ø 90cm H 73,5cm	Ø 35,43in H 28,94in
W 70cm L 70cm H 73,5cm	W 27,56in L 27,56in H 28,94in	W 80cm L 80cm H 73,5cm	W 31,49in L 31,49in H 28,94in	W 90cm L 90cm H 73,5cm	W 35,43in L 35,43in H 28,94in	W 120cm L 80cm H 73,5cm	W 47,24in L 31,49in H 28,94in

Peso | Weight | Poids

7,54 - 9,73 - 10,91 - 12,51 - 10,95 - 12,42 - 14,6 - 16,4 kg



HPL	Measurements	Ø60	Ø70	Ø80	Ø90	70 x 70	80 x 80	90 x 90	120 x 80
		3 PLegs	3 PLegs	4 PLegs	4 PLegs	4 PLegs	4 PLegs	4 PLegs	4 PLegs
Blanco White		●	●			●			
Negro Black		●	●			●			
Roble Natural Natural Oak		●	●	●	●	●	●	●	●
Madera Lavada Washed Wood		●	●	●	●	●	●	●	●
Roble Ceniza Ashen Oak		●	●	●	●	●	●	●	●

Logística | Logistics | Logistique

		20'	40'	40' HC	70 m ³	100 m ³
3 patas legs	1X	765	1575	1800	2100	2400
4 patas legs	1X	1020	2100	2400	2800	3200

New Flash

Designed by Josep Lluscà

Mesa para uso interior y exterior. Sobre inyectado en polipropileno. Patas de aluminio anodizado de alta resistencia. Estructura de acero zincado pintada por pulverización al horno testeado conforme normativa anticorrosión UNE EN/ISO 9227:2012. Protección UV.

Table for indoor and outdoor use. Table top injected with polypropylene. High resistance anodized aluminium legs. Powder coated zink steel structure in accordance to corrosion regulation UNE EN/ISO 9227:2012. UV Protection.

Table d'intérieur et extérieur. Plateau injecté en polypropylène. Pieds en aluminium anodisé de haute résistance. Structure d'acier zingué peint par pulvérisation au four en conformité avec la réglementation anticorrosion UNE EN/ISO 9227:2012. Protection UV.



Medidas | Measures | Mesures

W 90cm L 90cm H 74cm	W 35,43in L 35,43in H 29,13in	W 160cm L 90cm H 74cm	W 62,99in L 35,43in H 29,13in
----------------------------	-------------------------------------	-----------------------------	-------------------------------------



Peso | Weight | Poids

11,58 - 16,59 kg

Logística | Logistics | Logistique

		20'	40'	40' HC	70 m ³	100 m ³
	1X	150	390	384	448	795

Certificaciones | Certifications

UNEEN581-1, UNEEN581-2

Wood New Flash

Designed by Josep Llusçà



Mesa para uso interior. Sobre inyectado en polipropileno. Patas de madera. Protección UV.

Table for indoor use. Table top injected with polypropylene. Wood legs. UV Protection.

Table d'intérieur. Plateau injecté en polypropylène. Pieds de bois. Protection UV.

Medidas | Measures | Measures

W 90cm	W 35,43in	W 160cm	W 62,99in
L 90cm	L 35,43in	L 90cm	L 35,43in
H 74cm	H 29,13in	H 74cm	H 29,13in



Peso | Weight | Poids

11,85 - 16,59 kg

Logística | Logistics | Logistique

1X	180	390	442	448	578

Certificaciones | Certifications

UNEEN581-1, UNEEN581-2

New Dessa

Designed by Josep Llusçà



Mesa para uso interior y exterior. Sobre y patas inyectados en polipropileno. Estructura de acero zincado pintada por pulverización al horno testeado conforme normativa anticorrosión UNE EN/ISO 9227:2012. Protección UV.

Table for indoor and outdoor use. Table top and legs injected in polypropylene. Powder coated zinc steel structure in accordance to corrosion regulation UNE EN/ISO 9227:2012. UV protection.

Table pour usage intérieur et extérieur. Plateau et pieds injectés en polypropylène. Structure d'acier zingué peint par pulvérisation au four en conformité avec la réglementation anticorrosion UNE EN/ISO 9227:2012.

Medidas | Measures | Measures

W 90cm	W 35,43in	W 160cm	W 62,99in
L 90cm	L 35,43in	L 90cm	L 35,43in
H 74cm	H 29,13in	H 74cm	H 29,13in



Peso | Weight | Poids

11,74 - 16,75 kg

Logística | Logistics | Logistique

1X	192	390	392	448	795

Certificaciones | Certifications

UNEEN581-1

Noa

Designed by David Carrasco Barceló



Mesa para uso interior y exterior. Sobre y patas inyectados en polipropileno. Patas en polipropileno y reforzada con fibra de vidrio en las patas. Protección UV.

Table for indoor and outdoor use. Table top and legs injected in polypropylene. Fiber glass in the legs. UV protection. Available in 2 sizes.

Table pour usage intérieur et extérieur. Plateau et pieds injectés en polypropylène. Pieds en polypropylène et renforcés avec de la fibre de verre dans les pieds. Protection UV.

Medidas | Measures | Measures

W 90cm	W 35,43in	W 160cm	W 62,99in
L 90cm	L 35,43in	L 90cm	L 35,43in
H 74cm	H 29,13in	H 74cm	H 29,13in



Peso | Weight | Poids

11,85 - 21,65 kg

Logística | Logistics | Logistique

1X	272	556	556	710	750

Certificaciones | Certifications

UNEEN581-1, UNEEN581-3

Toledo Aire square

Designed by Jorge Pensi



Mesa para uso interior y exterior. Estructura de aluminio pintado y sobre en compacto fenólico del mismo color.

Table for indoor and outdoor use. Painted aluminium structure with an HPL table top of the same colour.

Table pour usage intérieur et extérieur. Structure en aluminium peint et plateau en compact phénolique du même coloris.

Medidas | Measures | Mesures

W 70cm x L 70cm x H 74cm
W 27,56in x L 27,56in x H 29,13in

Peso | Weight | Poids

11,36 kg

Logística | Logistics | Logistique

1X	154	350	350	462	504



Toledo Aire round

Designed by Jorge Pensi



Mesa para uso interior y exterior. Estructura de aluminio pintado y sobre en compacto fenólico del mismo color.

Table for indoor and outdoor use. Painted aluminium structure with an HPL table top of the same colour.

Table pour usage intérieur et extérieur. Structure en aluminium peint et plateau en compact phénolique du même coloris.

Medidas | Measures | Mesures

Ø 70cm x H 74cm
Ø 27,56in x H 29,13in

Peso | Weight | Poids

8,94 kg

Logística | Logistics | Logistique

1X	154	350	350	462	540



Toledo Aire XL square

Designed by Jorge Pensi



Mesa para uso interior y exterior. Estructura de aluminio pintado y sobre en compacto fenólico del mismo color.

Table for indoor and outdoor use. Painted aluminium structure with an HPL table top of the same colour.

Table pour usage intérieur et extérieur. Structure en aluminium peint et plateau en compact phénolique du même coloris.

Medidas | Measures | Mesures

W 90cm	W 35,43in	W 100cm	W 29,13in
L 90cm	L 35,43in	L 100cm	L 29,13in
H 74,4cm	H 29,29in	H 74,4cm	H 29,29in

Peso | Weight | Poids

20 - 23 kg

Logística | Logistics | Logistique

1X	72	156	182	210	238



Toledo Aire XL

round

Designed by Jorge Pensi



Mesa para uso interior y exterior. Estructura de aluminio pintado y sobre en compacto fenólico del mismo color.

Table for indoor and outdoor use. Painted aluminium structure with an HPL table top of the same colour.

Table pour usage intérieur et extérieur. Structure en aluminium peint et plateau en compact phénolique du même coloris.

Medidas | Measures | Mesures

Ø90cm | Ø 35,43in Ø100cm | Ø 39,37in
H 74,4cm | H 29,29in H 74,4cm | H 29,29in

Peso | Weight | Poids

20 kg

Logística | Logistics | Logistique



1X	72	156	182	210	238

Toledo

square

Designed by Jorge Pensi



Mesa para uso interior y exterior. Estructura de aluminio pintado y sobre en compacto fenólico del mismo color.

Table for indoor and outdoor use. Painted aluminium structure with an HPL table top of the same colour.

Table pour usage intérieur et extérieur. Structure en aluminium peint et plateau en compact phénolique du même coloris.

Medidas | Measures | Mesures

W 70cm x L 70cm x H 74cm
W 27,56in x L 27,56in x H 29,13in

Peso | Weight | Poids

11,36 kg

Logística | Logistics | Logistique



1X	154	350	350	462	504

Toledo

round

Designed by Jorge Pensi



Mesa para uso interior y exterior. Estructura de aluminio pintado y sobre en compacto fenólico del mismo color.

Table for indoor and outdoor use. Painted aluminium structure with an HPL table top of the same colour.

Table pour usage intérieur et extérieur. Structure en aluminium peint et plateau en compact phénolique du même coloris.

Medidas | Measures | Mesures

Ø 70cm x H 74cm
Ø 27,56in x H 29,13in

Peso | Weight | Poids

8,94 kg

Logística | Logistics | Logistique



1X	154	350	350	462	540

Toledo XL

square

Designed by Jorge Pensi

Mesa para uso interior y exterior. Estructura de aluminio pintado y sobre en compacto fenólico del mismo color.

Table for indoor and outdoor use. Painted aluminium structure with an HPL table top of the same colour.

Table pour usage intérieur et extérieur. Structure en aluminium peint et plateau en compact phénolique du même coloris.



Medidas | Measures | Mesures

W 90cm	W 35,43in	W 100cm	W 29,13in
L 90cm	L 35,43in	L 100cm	L 29,13in
H 74,4cm	H 29,29in	H 74,4cm	H 29,29in



Peso | Weight | Poids

20 - 23 kg

Logística | Logistics | Logistique

1X	72	156	182	210	238

Toledo XL

round

Designed by Jorge Pensi

Mesa para uso interior y exterior. Estructura de aluminio pintado y sobre en compacto fenólico del mismo color.

Table for indoor and outdoor use. Painted aluminium structure with an HPL table top of the same colour.

Table pour usage intérieur et extérieur. Structure en aluminium peint et plateau en compact phénolique du même coloris.



Medidas | Measures | Mesures

Ø90cm	Ø 35,43in	Ø100cm	Ø 39,37in
H 74,4cm	H 29,29in	H 74,4cm	H 29,29in



Peso | Weight | Poids

20 - 23 kg

Logística | Logistics | Logistique

1X	72	156	182	210	238

Barcino Pie Central

square

Designed by Joan Gaspar

Mesa para uso interior y exterior. Estructura de aluminio anodizado pintado por pulverización y secado al horno de 40 x 40 mm y 1,50 mm de grosor. Sobre de 4 mm de grosor.

Table for indoor and outdoor use. Powder coated anodized aluminium frame and oven-drying 40 x 40 mm and 1,50 mm thick. Table top of 3 mm. thickness.

Table pour usage intérieur et extérieur. Structure en aluminium anodisé peinte par pulvérisation et séchée au four 40 x 40 mm et 1,50 mm de grosseur. Plateau de 3 mm de grosseur.



Medidas | Measures | Mesures

W 80cm	W 31,49in	W 90cm	W 35,43in
L 80cm	L 31,49in	L 90cm	L 35,43in
H 74cm	H 29,13in	H 74cm	H 29,13in

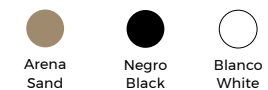

Peso | Weight | Poids

26 - 33 kg

Logística | Logistics | Logistique

1X	200	440	440	520	-

Certificaciones | Certifications

UNEEN581-1

Barcino Pie Central

round

Designed by Joan Gaspar



Certificaciones | Certifications

UNEEN581-1

Mesa para uso interior y exterior. Estructura de aluminio anodizado pintado por pulverización y secado al horno de Ø40 mm y 1,50 mm de grosor. Sobre de 4 mm de grosor.

Table for indoor and outdoor use. Powder coated anodized aluminium frame and oven-drying 40 x 40 mm and 1,50 mm thick. Table top of 3 mm. thickness.

Table pour usage intérieur et extérieur. Structure en aluminium anodisé peinte par pulvérisation et séchée au four 40 x 40 mm et 1,50 mm de grosseur. Plateau de 3 mm de grosseur.

Medidas | Measures | Measures

Ø60cm | Ø 23,62in Ø80cm | Ø 31,49in
H 74cm | H 29,13in H 74cm | H 29,13in

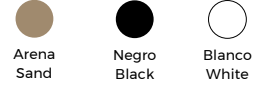

Peso | Weight | Poids

17 - 22 kg

Logística | Logistics | Logistique

1X	220	500	500	600	0

Barcino Pie Central

tall

Designed by Joan Gaspar



Certificaciones | Certifications

UNEEN581-1

Mesa para uso interior y exterior. Estructura de aluminio anodizado pintado por pulverización y secado al horno de Ø40 mm y 1,50 mm de grosor. Sobre de 4 mm de grosor.

Table for indoor and outdoor use. Powder coated anodized aluminium frame and oven-drying 40 x 40 mm and 1,50 mm thick. Table top of 3 mm. thickness.

Table pour usage intérieur et extérieur. Structure en aluminium anodisé peinte par pulvérisation et séchée au four 40 x 40 mm et 1,50 mm de grosseur. Plateau de 3 mm de grosseur.

Medidas | Measures | Measures

Ø 60cm x H 110cm
Ø 23,62in x H 3,31in

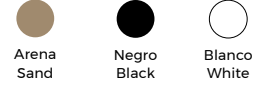

Peso | Weight | Poids

14 kg

Logística | Logistics | Logistique

1X	297	675	675	800	-

Mesa Bini

Designed by Joan Gaspar

NEW



Certificaciones | Certifications

UNEEN581-1, UNEEN581-2

Mesa Bini para uso interior y exterior. Fabricada en polipropileno con fibra de vidrio, con protección UV.

Bini table for indoor and outdoor use. It is made of polypropylene with fiberglass, with UV protection.

Table Bini pour usage intérieur et extérieur. Fabriqué en polypropylène avec fibre de verre, avec protection UV.

Medidas | Measures | Measures

Ø70cm x H 75,5cm
Ø27,56in x H 29,72in



Peso | Weight | Poids

7,34 kg

Logística | Logistics | Logistique

1X	450	912	1056	1254	1360

Mesa Bini

lounge

Designed by Joan Gaspar

NEW



Mesa Bini Lounge para uso interior y exterior. Fabricado en polipropileno con fibra de vidrio, con protección UV.

Bini Lounge table for indoor and outdoor use. Made of polypropylene with fiberglass, with UV protection.

Table Bini Lounge pour usage intérieur et extérieur. Fabriqué en polypropylène avec fibre de verre, avec protection UV.

Medidas | Measures | Mesures

Ø70cm x H 40cm
Ø27,56in x H 15,75in

Peso | Weight | Poids

5,5 kg

Logística | Logistics | Logistique



Certificaciones | Certifications

UNEEN581-1, UNEEN581-2

1X	450	912	1056	1254	1360

Inox Pie Paris-4

Designed by Jorge Pensi



Pie central para uso interior y exterior de fundición de aluminio acabado con un pulido impecable. Base con cuatro pies.

Pedestal base for indoor and outdoor use, made of cast aluminum finished with an impeccable polish. Base with four or five feet.

Pied central pour usage intérieur et extérieur injecté en aluminium avec une finition et polissage impeccables. Base avec 4 ou 5 pieds.

Medidas | Measures | Mesures

Ø 60cm	Ø 23,62in	Ø 70cm	Ø 27,56in	W 60cm	W 23,62in
H 70,5cm	H 27,75in	H 70,5cm	H 27,75in	L 60cm	L 23,62in
				H 70,5cm	H 27,75in

Peso | Weight | Poids

9,42 - 12,13 - 9,42 kg

Logística | Logistics | Logistique



1X	135	450	450	-	495

Inox Pie Paris-4

tall

Designed by Jorge Pensi



Pie central para uso interior y exterior de fundición de aluminio acabado con un pulido impecable. Base con cuatro pies.

Central foot for internal and external use made of cast aluminium finished with an impeccable polish. Base with four feet.

Pied central pour usage intérieur et extérieur injecté en aluminium avec une finition et polissage impeccables. Base avec 4 pieds.

Medidas | Measures | Mesures

Ø 60cm x H 110cm
Ø 23,62in x H 43,31in

Peso | Weight | Poids

11,78 kg

Logística | Logistics | Logistique



1X	126	420	420	-	462

Inox Pie Paris-5

Designed by Jorge Pensi

Pie central para uso interior y exterior de fundición de aluminio acabado con un pulido impecable. Base con cinco pies.

Pedestal base for indoor and outdoor use, made of cast aluminum finished with an impeccable polish. Base with five feet.

Pied central pour usage intérieur et extérieur injecté en aluminium avec une finition et polissage impeccables. Base avec 5 pieds.



Medidas | Measures | Measures

Ø 80cm H 70cm	Ø 31,49in H 27,56in	Ø 90cm H 70cm	Ø 35,43in H 27,56in	Ø 100cm H 70cm	Ø 39,37in H 27,56in	Ø 110cm H 70cm	Ø 43,31in H 27,56in	Ø 120cm H 70cm	Ø 47,24in H 27,56in
W 80cm L 80cm H 70cm	W 31,49in L 31,49in H 27,56in	W 90cm L 90cm H 70cm	W 35,43in L 35,43in H 27,56in						

Peso | Weight | Poids

15,94 - 26,3 - 9,42 kg

Logística | Logistics | Logistique

1X	120	288	288	-	312

Aluminio
Aluminum

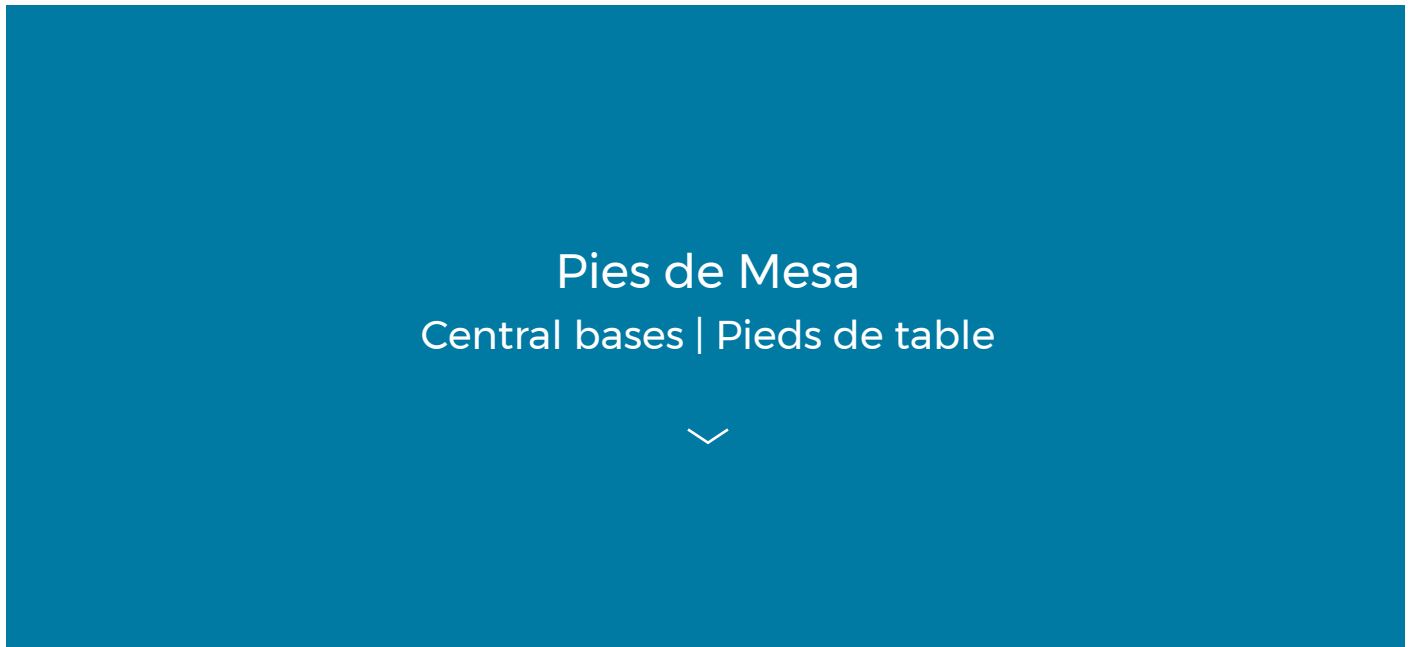

Vela S

Designed by Fabrizio Batoni

Pie central para uso interior y exterior compuesto por dos bases inyectadas en fibra de vidrio con PP mediante tecnología de moldeo asistida por gas, enlazadas entre sí por una barra de aluminio. Protección UV.

Central base for indoor use and exterior composed of two bases injected in PP with fiberglass using gas assisted molding technology which are united by an aluminum bar. UV protection.

Base centrale pour une utilisation en intérieur et extérieur composé de deux bases injecté en PP avec fibre de verre utilisant la technologie de moulage assisté par gaz qui sont unis par une barre en aluminium. Protection UV.



Medidas | Measures | Measures

W 61,5cm x L 60cm x H 72,5cm
W 24,2in x L 23,62in x H 28,54in

Peso | Weight | Poids

4 kg

Logística | Logistics | Logistique

1X	-	312	-	360	-

Rojo Red
 Arena Sand
 Negro Black
 Blanco White

IIDA Excellence IIDA/HD Product Design 2014

Certificaciones | Certifications

UNEN15372

resol.es

* Sujeto a condiciones. Por favor, consultar.
 * Subject to conditions. Please inquire.
 * Sous réserve de conditions. Merci de consulter.

Vela M

Designed by Fabrizio Batoni



Certificaciones | Certifications
UNEN15372

Pie central para uso interior y exterior compuesto por dos bases inyectadas en fibra de vidrio con PP mediante tecnología de moldeo asistida por gas, enlazadas entre sí por una barra de aluminio. Protección UV.

Central base for indoor use and exterior composed of two bases injected in PP with fiberglass using gas assisted molding technology which are united by an aluminum bar. UV protection.

Base centrale pour une utilisation en intérieur et extérieur composé de deux bases injecté en PP avec fibre de verre utilisant la technologie de moulage assisté par gaz qui sont unis par une barre en aluminium. Protection UV.

Medidas | Measures | Mesures

W 61,5cm x L 79cm x H 72,5cm
W 24,21in x L 31,10in x H 28,54in

Peso | Weight | Poids

4,65 kg

Logística | Logistics | Logistique

	20'	40'	40' HC	70 m ³	100 m ³
1X	-	264	-	300	-

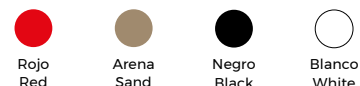

Vela L

Designed by Fabrizio Batoni



Certificaciones | Certifications
UNEN15372

Pie central para uso interior y exterior compuesto por dos bases inyectadas en fibra de vidrio con PP mediante tecnología de moldeo asistida por gas, enlazadas entre sí por una barra de aluminio. Protección UV.

Central base for indoor use and exterior composed of two bases injected in PP with fiberglass using gas assisted molding technology which are united by an aluminum bar. UV protection.

Base centrale pour une utilisation en intérieur et extérieur composé de deux bases injecté en PP avec fibre de verre utilisant la technologie de moulage assisté par gaz qui sont unis par une barre en aluminium. Protection UV.

Medidas | Measures | Mesures

W 61,5cm x L 142cm x H 72,5cm
W 24,21in x L 55,91in x H 28,54in

Peso | Weight | Poids

5,9 kg

Logística | Logistics | Logistique

	20'	40'	40' HC	70 m ³	100 m ³
1X	-	144	-	160	-

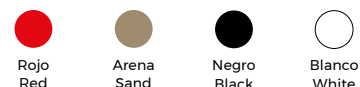

Toledo

Designed by Jorge Pensi



Certificaciones | Certifications
UNEEN581-1, UNEEN581-2

Pie de mesa para uso interior y exterior. Estructura de aluminio pintando.

Table base for indoor and outdoor use. Painted aluminum structure.

Base de table pour une utilisation intérieure et extérieure. Structure en aluminium peint.

Medidas | Measures | Mesures

W 50cm x L 50cm x H 73cm
W 19,69in x L 19,69in x H 28,74in

Peso | Weight | Poids

4,38 kg

Logística | Logistics | Logistique

	20'	40'	40' HC	70 m ³	100 m ³
1X	286	650	650	858	936



Drop



Pie de mesa de aluminio pintado para uso interior y exterior con sistema abatible.

Table base of painted aluminum for indoor and outdoor use with folding system.

Base de table en aluminium peint pour une utilisation intérieure et extérieure avec système rabattable.

Medidas | Measures | Measures

W 50cm x L 50cm x H 72cm
W 19,69in x L 19,69in x H 28,35in

Peso | Weight | Poids

8,36 kg

Logística | Logistics | Logistique

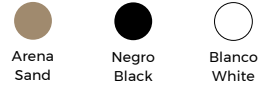

1X	286	650	650	858	936

Fall



Pie de mesa de aluminio pintado para uso interior y exterior con sistema abatible.

Table base of painted aluminum for indoor and outdoor use with folding system.

Base de table en aluminium peint pour une utilisation intérieure et extérieure avec système rabattable.

Medidas | Measures | Measures

W 50cm x L 50cm x H 70cm
W 19,69in x L 19,69in x H 27,56in

Peso | Weight | Poids

7,48 kg

Logística | Logistics | Logistique

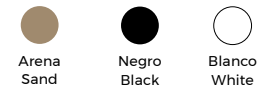

1X	630	1300	1500	1700	1900

Sputnik

Designed by Josep Llusçà



Pie central simple para uso interior y exterior. El pie se compone de dos partes, una carcasa inyectada en poliamida y un contrapeso de hierro pintado. Tubo de aluminio anodizado de \varnothing 60 x 2 mm. de grosor en acabado brillante, mate o pintado blanco o negro. Protección contra rayos UV. Nivelador en una pata.

Single pedestal base for indoor and outdoor use. The base is composed of two pieces, a casing injected with polyamide and a painted iron counterweight. Anodized aluminium tube, \varnothing 60 x 2 mm thick, shiny, matt or white or black painted finish. UV protection. Leveller in one leg.

Pied central simple d'intérieur et extérieur. Pied central fait en deux partis, une carcasse injectée en polyamide et un contrepoids en fer, peint. Tube en aluminium anodisé brillant ou mat, ou tube en aluminium peint blanc ou noir de \varnothing 60 x 2 mm de grosseur. Protection contre les rayons UV. Niveleur sur un pied.

Medidas | Measures | Mesures

W 52cm x L 52cm x H 71,5cm
W 20,47in x L 20,47in x H 28,15in

Peso | Weight | Poids

5,82 kg

Logística | Logistics | Logistique

1X	565	1171	1320	1414	2020

Estructura | Structure | Structure

Aluminio mate Matt aluminum	Aluminio brillante Bright aluminum	Negro Black	Blanco White
Pie Foot Pied			
Negro Black	Blanco White		

Sputnik

tall

Designed by Josep Llusçà



Pie central alto para uso interior y exterior. El pie se compone de dos partes, una carcasa inyectada en poliamida y un contrapeso de hierro pintado. Tubo de aluminio anodizado de \varnothing 60 x 2 mm. de grosor en acabado brillante, mate o pintado blanco o negro. Protección contra rayos UV. Nivelador en una pata.

High pedestal base for indoor and outdoor use. The base is composed of two pieces, a casing injected with polyamide and a painted iron counterweight. Anodized aluminium tube, \varnothing 60 x 2 mm thick, shiny, matt or white or black painted finish. UV protection. Leveller in one leg.

Pied central haut d'intérieur et extérieur. Pied central fait en deux partis, une carcasse injectée en polyamide et un contrepoids en fer, peint. Tube en aluminium anodisé brillant ou mat, ou tube en aluminium peint blanc ou noir de \varnothing 60 x 2 mm de grosseur. Protection contre les rayons UV. Niveleur sur un pied.

Medidas | Measures | Mesures

W 52cm x L 52cm x H 110cm
W 20,47in x L 20,47in x H 43,31in

Peso | Weight | Poids

6,78 kg

Logística | Logistics | Logistique

1X	565	1171	1320	1414	2020

Estructura | Structure | Structure

Aluminio mate Matt aluminum	Aluminio brillante Bright aluminum	Negro Black	Blanco White
Pie Foot Pied			
Negro Black	Blanco White		

Sputnik

double

Designed by Josep Llusçà



Pie central doble para uso interior y exterior. El pie se compone de dos partes, una carcasa inyectada en poliamida y un contrapeso de hierro pintado. Tubo de aluminio anodizado de \varnothing 60 x 2 mm. de grosor en acabado brillante, mate o pintado blanco o negro. Protección contra rayos UV. Nivelador en una pata.

Double pedestal base for indoor and outdoor use. The base is composed of two pieces, a casing injected with polyamide and a painted iron counterweight. Anodized aluminium tube, \varnothing 60 x 2 mm thick, shiny, matt or white or black painted finish. UV protection. Leveller in one leg.

Pied central double d'intérieur et extérieur. Pied central fait en deux parties, une carcasse injectée en polyamide et un contrepoids en fer, peint. Tube en aluminium anodisé brillant ou mat, ou tube en aluminium peint blanc ou noir de \varnothing 60 x 2 mm de grosseur. Protection contre les rayons UV. Niveleur sur un pied.

Medidas | Measures | Mesures

W 63,5cm x L 102cm x H 71,5cm
W 25,00in x L 40,16in x H 28,15in

Peso | Weight | Poids

9,86 kg

Logística | Logistics | Logistique

1X	248	514	583	621	887

Estructura | Structure | Structure

Aluminio mate Matt aluminum	Aluminio brillante Bright aluminum	Negro Black	Blanco White
Pie Foot Pied			
Negro Black	Blanco White		

Tableros y combinaciones de mesas

Tops and table combinations | Plateaus et combinaisons de tables



Tablero Werzalit®

Werzalit® table top

Plateau Werzalit®

Los tableros Werzalit se fabrican según un procedimiento patentado especialmente para su uso en interiores y exteriores. Debido al núcleo del material altamente triturado y prensado y con la superficie prensada homogéneamente con materiales derivados de la madera, los tableros Werzalit logran una larga vida útil, son sumamente sólidos y totalmente resistentes a la intemperie. No se recomienda exponer el werzalit en colores oscuros directamente al sol para evitar que se curve o deforme por efecto de la acumulación de calor.

Werzalit table tops are manufactured specially for use inside and outside using a patented procedure. Due to its high density material core manufactured from naturally grown wood and the surface pressed homogeneously with the wood material, Werzalit table tops are durable, hard-wearing and completely weatherproof. We do not recommend to expose dark werzalit table tops to the sun in order to avoid curving or deforming through the effect of heat accumulation.

Les plateaux de tables Werzalit sont fabriqués selon un procédé breveté en particulier pour un usage intérieur comme extérieur. Grâce à son noyau de haute densité avec particules de bois compressées et homogènes, les plateaux de tables Werzalit sont durables, robustes et absolument résistant aux intempéries. Nous recommandons de ne pas exposer les plateaux Werzalit foncés directement au soleil afin d'éviter qu'ils se courbent et se déforment par l'accumulation de chaleur.



Blanco
White | Blanc



Stratos
Stratos | Stratos



Wengé
Wenge | Wenge

Grueso | Thickness | Épaisseur
20 mm



Cualquier otro color bajo pedido y plazo de entrega. Consultar al Departamento comercial.

Any other colour upon request, delivery time varies. Ask the Sales Department.

N'importe quelle couleur sur commande et délai de livraison. Consulter le Département Commercial.

Tablero compacto fenólico

HPL table top

Plateau Phénolique

El compacto fenólico es un laminado de alta presión (HPL). Su composición consiste en capas de papel aglutinado con resinas termoestables de melamina-formaldehído en su superficie y de fenol-formaldehído en su interior. Todo ello es prensado a alta presión (≥ 7 MPa) y alta temperatura ($\geq 120^\circ$ C), dando como resultado uno de los materiales más versátiles por su apariencia, estética, resistencia y durabilidad.

Su extraordinaria superficie está constituida por una hoja impregnada con resina de melamina-formaldehído, que es la que aporta el diseño. Por encima de este diseño decorativo lleva una hoja adicional (overlay), impregnada también en resina melamínica, que le aporta gran resistencia al rayado y la abrasión. Finalmente, el núcleo central, compuesto de papel kraft impregnado en resina fenólica, le dotan de gran resistencia al impacto. Tanto el overlay como el núcleo central de resina fenólica, son los dos elementos diferenciadores del laminado HPL.

El laminado HPL posee la cualidad de ser resistente al calor, al rayado, a la abrasión, impermeable e inerte debido a su superficie no porosa, lo cual lo hace apto para uso interior y exterior e ideal para uso contract.

HPL is a high pressure laminate (HPL). Its composition is bonded paper layers with thermosetting resins, melamine-formaldehyde on its surface and phenol-formaldehyde inside. All this is pressed at high pressure (≥ 7 MPa) and high temperature ($\geq 120^\circ$ C), resulting in one of the most versatile materials in appearance, aesthetics, strength and durability.

Its extraordinary surface is constituted by a sheet impregnated with melamine-formaldehyde resin, which gives it a unique design. Above this decorative design it has an additional sheet (overlay) that's also impregnated with melamine resin, which makes it highly resistant to scratches and abrasion. Finally, the central core, consisting of kraft paper impregnated with phenolic resin, provide it with high impact resistance. Both the overlay and the core of phenolic resin are the two distinguishing features of HPL.

The HPL has the peculiarity of being resistant to heat, scratch, abrasion, waterproof and inert due to its non-porous surface, making it suitable for indoor and outdoor use and ideal for contract use.

La résine phénolique est un stratifié compact (HPL) de haute pression. Sa composition est constituée de couches de papier avec des résines thermodurcissables, des résines mélamine-formaldéhyde, sur sa surface et de phénol-formaldéhyde à l'intérieur. Tout cela est pressé à haute pression (≥ 7 MPa) et haute température ($\geq 120^\circ$ C), résultant un des matériaux les plus polyvalents pour son apparence, esthétique, solidité et durabilité.

Sa surface extraordinaire est constituée par une feuille imprégnée de résine mélamine-formaldéhyde, qui elle même apporte son dessin. Au-dessus de ce dessin décoratif, s'ajoute une feuille supplémentaire (overlay) imprégnée de résine mélamine également, ce qui donne une haute résistance les rayures et l'abrasion. Enfin, le noyau central, composé de papier kraft imprégné de résine phénolique, lui permet une résistance aux chocs élevée. Autant la superposition comme le noyau de résine phénolique sont les deux traits distinctifs de HPL.

Le HPL a la qualité d'être résistant à la chaleur, aux égratignures, à l'abrasion, imperméable à l'eau et inerte en raison de sa surface non poreuse, ce qui convient pour usage intérieur et extérieur et idéal pour une utilisation contrat.

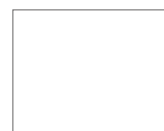

Blanco
White
Blanc



Negro
Black
Noir

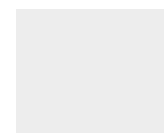

Plata
Silver
Argent



Madera lavada
Washed Wood
Bois Delavé



Roble Ceniza
Ashen Oak
Chêne Cendré



Roble Natura
Natural Oak
Chêne Naturel

Grueso | Thickness | Épaisseur
10 mm

Tablero DUROLight

DUROLight table top

Plateau DUROLight

Los tableros DUROLight son por su resistencia una opción idónea para el uso interior, y perfectamente combinable con la gama de sillas de Garbar. Están realizados de melamina con una imprimación de resina en la superficie que los protege de arañazos y de altas temperaturas (hasta 180°C). Los cantos están sellados con ABS para garantizar un acabado perfecto y resistente (Pruebas realizadas demuestran que son necesarios más de 1.5 Newton para conseguir arañar la superficie y 350 rotaciones para que se experimente desgaste.) Disponibles en color wengé, pino vintage y blanco.

The DUROLight tabletops are an ideal option for indoor use due to their resistance, and perfectly combinable with the range of Garbar. They are made of melamine with a resin coating on the surface, which protects them from scratches and high temperatures (up to 180°C). The edges are ABS sealed in order to guarantee a perfect and resistant finish. (Tests carried out showed that more than 1.5 Newton is necessary to achieve scratching the surface and 350 rotations in order to show wear.) Available in the colours wenge, vintage pine and white.

La résistance des planches DUROLight en fait l'option idéale pour un usage intérieur, et pouvant être parfaitement combinées avec la gamme de Garbar. Ils sont fabriqués en mélamine avec une couche de résine en surface protégeant des rayures et des hautes températures (jusqu'à 180°C) Les bords sont collés par ABS afin de garantir une finition parfaite et résistante. (Les tests réalisés démontrent qu'il faut plus de 1,5 Newton pour parvenir à rayer la surface et 350 rotations pour que l'usure commence.) Couleurs disponibles: wengé, pin vintage et blanc.



Cualquier otro color bajo pedido y plazo de entrega. Consultar al Departamento comercial.

Any other colour upon request, delivery time varies. Ask the Sales Department.

N'importe quelle couleur sur commande et délai de livraison. Consulter le Département Commercial.

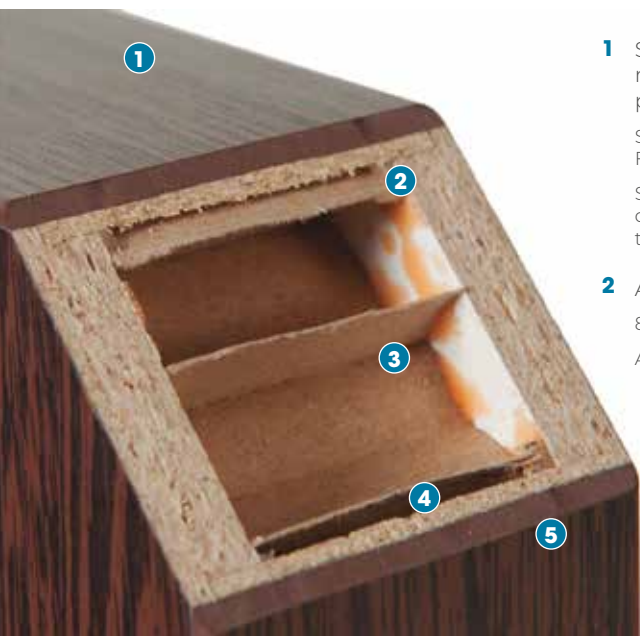

1 Standard: acabado de superficie de melamina decorativa + revestimiento protector transparente.

Standard: Decorative Melamine Surface Finish + Extra Transparent Overlay.

Standard: Finition de surface de mélamine décorative + revêtement protecteur transparent.

2 Aglomerado de 8 mm.

8 mm Chipboard layer.

Agglomérat de 8 mm.

3 Núcleo Interno Alveolar.

Internal Honeycomb core.

Noyau interne alvéolaire.

4 Canto de Unión de 3 mm de ABS inyectado.

3 mm Support Edge of foamed ABS.

Bord d'union de 3 mm en ABS injecté.

5 Canto Decorativo de 2 mm de ABS.

2 mm ABS Decor Edge.

Bord décoratif de 2 mm en ABS.



Blanco
White | Blanc



Cemento
Cement | Ciment



Wengé
Wenge | Wenge



Roble Natural
Vintage
Natural Vintage Oak
Chêne Natural Vintage



Pino Vintage
Vintage Pine
Pin Vintage

Combinaciones de mesas

table combinations | combinaisons de tables

Material
Material
Matériel

HPL

Blanco
White | Blanc

Negro
Black | Noir

Plata
Silver | Argent

Medidas Measures Measures	Toledo	Fall	Drop	Vela S	Vela M	Vela L	Sputnik	Sputnik alta	Sputnik doble
Ø 60							•	•	
Ø 70	•	•	•	•			•		
Ø 80	•	•	•	•			•		
Ø 90				•					
60 x 60							•		
70 x 70	•	•	•	•					
80 x 80	•	•	•	•					
90 x 90				•					
120 x 80					•				•
180 x 90						•			
200 x 90						•			

HPL
Madera
Wood
Bois

Roble natural
Natural oak
Chêne naturel

Roble ceniza
Ashen oak
Chêne cendré

Madera lavada
Washed wood
Bois délavé

Ø 80	•	•	•	•			•		
Ø 90				•					
70 x 60		•	•	•			•		
70 x 70	•	•	•	•			•		
80 x 80	•	•	•	•					
90 x 90				•					
120 x 80					•				•
180 x 90						•			

Werzalit

Blanco
White | Blanc

Stratos
Stratos | Stratos

Wengé
Wenge | Wenge

Ø 60							•	•	
60 x 60							•		
70 x 70							•		
120 x 80									•

Durolight

68 x 68							•		
---------	--	--	--	--	--	--	---	--	--

Crystal templado

Ø 70				•					
Ø 80				•					
Ø 90				•					
70 x 70				•					
80 x 80				•					
90 x 90				•					
120 x 80					•				
150 x 110					•				
180 x 90						•			

Las combinaciones disponibles han sido revisadas y aprobadas por el departamento técnico. Para productos destinados a zonas de alta salinidad consultar previamente con el Departamento Comercial.
The combinations available have been reviewed and approved by the technical department. Ask previously sales dept. for using our products in high salinity areas.
Les combinaisons disponibles ont été examinées et approuvées par le département technique. Produits destinés aux zones de haute salinité consulter à l'avance au dép. commercial.

Mesas Auxiliares

Side tables | Tables auxiliaires



Anthea Ottoman

Designed by Monica Armani



Estructura de aluminio lacada. Cojines y tapizados idóneos para el exterior. Amplia gama cromática y combinaciones. Apto para exterior.

Lacquered aluminum structure. Cushions and upholstery suitable for outdoors. Wide chromatic range and combinations. Suitable for outdoors.

Structure en aluminium laqué. Coussins et rembourrage adapté pour l'extérieur. Large gamme et combinaisons chromatiques. Convient pour l'extérieur.

Medidas | Measures | Mesures

W 75cm x L 79cm x H 37,5cm
W 29,53in x L 31,10in x H 14,76in

Peso | Weight | Poids

17,3 kg

Logística | Logistics | Logistique

	20'	40'	40 HIC	70 m3	100 m3
1X	61	134	158	-	158



Ver combinaciones de colores en página 447.
See color combinations on page 447.

Anthea Coffe Table

Designed by Monica Armani



Mesa auxiliar de estructura en aluminio de fundición y extrusión. Tablero de HPL con una amplia gama cromática y de combinaciones. Apta para exterior.

Side table made of casted an extruded aluminum structure with an HPL tabletop available in a wide range of colors and combinations. Suitable for exterior use.

Table d'appoint constituée d'une structure en aluminium extrudé moulé avec un plateau en HPL disponible dans une large gamme de couleurs et de combinaisons. Convient pour un usage extérieur.

Medidas | Measures | Mesures

W 80,5cm x L 80,5cm x H 25cm
W 31,69in x L 31,69in x H 9,84in

Peso | Weight | Poids

22,3 kg

Logística | Logistics | Logistique

	20'	40'	40 HIC	70 m3	100 m3
1X	67	147	174	-	174



Ver combinaciones de colores en página 447.
See color combinations on page 447.

* Sujeto a condiciones. Por favor, consultar.
* Subject to conditions. Please inquire.
* Sous réserve de conditions. Merci de consulter.

Anthea Side Table

Designed by Monica Armani

Mesa auxiliar baja. Estructura en tubo de aluminio y tablero en HPL. Amplia gama cromática y combinaciones. Apto para exterior.

Low side table. Structure in aluminum tube, HPL tabletop available in a wide range of colours and combinations. Suitable for outdoor use.

Table d'appoint basse. Structure en tube d'aluminium, plateau en HPL disponible dans une large gamme de couleurs et de combinaisons. Convient pour une utilisation en extérieur.



Medidas | Measures | Mesures

W 50cm x L 50cm x H 35cm
W 19,69in x L 19,69in x H 13,78in

Peso | Weight | Poids

6,2 kg

Logística | Logistics | Logistique

	20'	40'	40' HC	70 m ³	100 m ³
1X	33	72	85	-	85



Ver combinaciones de colores en página 447.
See color combinations on page 447.

Anou 4 Patas

pouf

Designed by Jorge Pensi

Pouf con estructura de acero pintado, tablero de HPL y cojín tapizado en tejido Sunbrella.

Pouf with a painted steel base, HPL table top and upholstered cushion with Sunbrella fabric.

Pouf avec pied en acier peint, plateau en HPL et coussin tapisé avec tissu Sunbrella.



Medidas | Measures | Mesures

W 71cm x L 58,7cm x H 48,4cm
W 27,95in x L 23,11in x H 19,06in

Peso | Weight | Poids

8,9 kg

Logística | Logistics | Logistique

	20'	40'	40' HC	70 m ³	100 m ³
1X	146	294	330	350	400



Certificaciones | Certifications

UNEEN581.3, BIFMAX5.7

Anou Toledo

pouf

Designed by Jorge Pensi

Pouf con pie de aluminio pintado, tablero de HPL y cojín tapizado en tejido Sunbrella.

Pouf with a painted aluminum base, HPL table top and a upholstered cushion with Sunbrella fabric.

Pouf avec pied en aluminium peint, plateau en HPL et coussin tapisé avec tissu Sunbrella.



Medidas | Measures | Mesures

W 71cm x L 58,7cm x H 48,4cm
W 27,95in x L 23,11in x H 19,06in

Peso | Weight | Poids

10,52 kg

Logística | Logistics | Logistique

	20'	40'	40' HC	70 m ³	100 m ³
1X	146	294	330	350	400



Certificaciones | Certifications

UNEEN581.3, BIFMAX5.8

Anou 4 Patas side table

Designed by Jorge Pensi



Mesa auxiliar con estructura de acero pintado y tablero de hpl.

Side table with a painted steel base and an hpl table top.

Table auxiliaire avec pied en acier peint et plateau en hpl.

Medidas | Measures | Mesures

W 67cm x L 54,7cm x H 35,4cm
W 26,38in x L 21,54in x H 13,94in

Peso | Weight | Poids

7,26 kg

Logística | Logistics | Logistique



Certificaciones | Certifications

UNEEN581.3,BIFMAX5.6

	20'	40'	60 HC	70 m ³	100 m ³
1X	225	482	520	550	600

Anou Toledo side table

Designed by Jorge Pensi



Mesa auxiliar con pie de aluminio pintado y tablero de hpl.

Side table with a painted aluminum base and an hpl table top.

Table auxiliaire avec pied en aluminium peint et plateau en hpl.

Medidas | Measures | Mesures

W 67cm x L 54,7cm x H 35,4cm
W 26,38in x L 21,54in x H 13,94in

Peso | Weight | Poids

8,9 kg

Logística | Logistics | Logistique



Certificaciones | Certifications

UNEEN581.3,BIFMAX5.5

	20'	40'	60 HC	70 m ³	100 m ³
1X	225	482	520	550	600

Espiga

Designed by Jordi Ribaudí



Mesa baja con estructura patin. Estructura de acero pintado. Sobre de HPL con efecto relieve en impresión digital. Tacos antideslizantes. Tornillería de acero inoxidable.

Low side table with sled base structure of painted. HPL tabletop with a relief effect in digital printing. Non-slip glides. Stainless steel hardware.

Table basse avec structure patin. Structure en acier peint. Dessus en phénolique, effet relief par impression digitale. Embouts antidérapants. Visserie en acier inoxydable.

Medidas | Measures | Mesures

W 66,2cm x L 64,6cm x H 29,3cm
W 26,06in x L 25,43in x H 11,54in

Peso | Weight | Poids

9,6 kg

Logística | Logistics | Logistique



	20'	40'	60 HC	70 m ³	100 m ³
2X	431	862	948	1034	-

Lucca 19

Designed by Joan Casas



Reposapiés. Perfil exclusivo de aluminio anodizado. Uniones de aluminio. Tacos antideslizantes. Tornillería de acero inoxidable. Textilene Batyline ignífugo.

Footrest. Exclusive anodized aluminium profile. Aluminium joints. Anti-slip feet. Screws made of stainless steel. Flame-retardant Textilene Batyline.

Repose-pieds. Profil exclusif en aluminium anodisé. Unions en aluminium. Embouts antidérapants. Visserie en acier inoxydable. Textilène Batyline ignifuge.

Medidas | Measures | Measures

W 49,3cm x L 65,2cm x H 34cm
W 19,41in x L 25,67in x H 13,39in

Peso | Weight | Poids

3,2 kg

Logística | Logistics | Logistique

2X	188	376	414	451	-

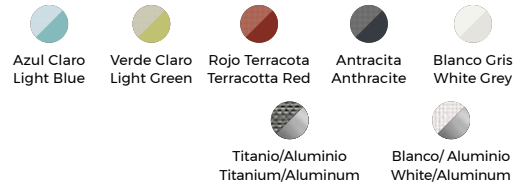

Lucca 18

Designed by Joan Casas



Carrito con ruedas de aluminio. Perfiles de aluminio anodizados. Sobre de HPL. Escuadras de unión de fundición de aluminio. Uniones de aluminio. Tacos antideslizantes. Tornillería de acero inoxidable.

Cart with aluminium wheels. Anodized aluminium profiles. HPL top. Joining brackets made of cast aluminium. Anti-slip feet. Screws made of stainless steel.

Chariot avec roues en aluminium. Profils en aluminium anodisé. Dessus en HPL. Équerres d'union en fonte d'aluminium. Unions en aluminium. Embouts antidérapants. Visserie en acier inoxydable.

Medidas | Measures | Measures

W 54cm x L 77,7cm x H 53cm
W 21,26in x L 30,59in x H 20,87in

Peso | Weight | Poids

7,34 kg

Logística | Logistics | Logistique

2X	135	270	296	323	-



Lucca 08

Designed by Joan Casas



Mesa baja con estructura de perfil de aluminio anodizado y sobre de HPL. Uniones de aluminio. Tacos antideslizantes. Tornillería de acero inoxidable.

Low table with anodized aluminium profile structure and HPL table top. Joints made of aluminium. Anti-slip feet. Screws made of stainless steel.

Table basse avec structure de profil en aluminium anodisé et dessus en HPL. Unions en aluminium. Embouts antidérapants. Visserie en acier inoxydable.

Medidas | Measures | Measures

W 90cm x L 90cm x H 36,3cm
W 35,43in x L 35,43in x H 14,29in

Peso | Weight | Poids

13,4 kg

Logística | Logistics | Logistique

1X	311	622	684	746	-

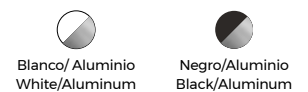

Salvora

Designed by



Mesa baja con estructura de perfil de aluminio anodizado y sobre HPL. Uniones de aluminio. Tacos antideslizantes. Tornillería de acero inoxidable,

Coffee table with anodised aluminium profile and HPL tabletop. Aluminium joints. Anti-slip pads. Stainless steel fasteners.

Table basse avec structure en profilé d'aluminium anodisé et plateau HPL. Raccords en aluminium. Patins antidérapants. Visserie en acier inoxydable.

Medidas | Measures | Measures

W 45cm x L 45cm x H 37cm
W 17,72in x L 17,72in x H 14,57in

Peso | Weight | Poids

5 kg

Logística | Logistics | Logistique

2X	156	344	392	-	506



Mesa Milano

coffe

Designed by Joan Gaspar



Mesa de centro apilable para uso interior y exterior. Estructura de aluminio anodizado pintado por pulverización y secado al horno.

stackable centre table for indoor and outdoor use. Anodised aluminium structure, spray finish and kiln-dried.

Table centrale empilable pour usage intérieur et extérieur. Structure en aluminium anodisé peint par pulvérisation et séché au four.

Medidas | Measures | Measures

W 60cm x L 101cm x H 35,8cm
W 23,62in x L 39,76in x H 14,09in

Peso | Weight | Poids

8 kg

Logística | Logistics | Logistique

1X	120	250	250	-	300



Mesa Milano

ice cube

Designed by Joan Gaspar



Mesa auxiliar de 50x45 cm para uso interior y exterior. Estructura de aluminio anodizado pintado por pulverización al horno, de 40x40 mm y 2 mm de grosor. Sobre 3 mm de grosor. Contiene cubitera de policarbonato transparente negro.

Side table 50x45 for indoor and outdoor use. Anodised aluminium structure, painted by oven spraying, 40x40 mm and 2 mm thick. About 3 mm thick. Contains black transparent polycarbonate cover.

Table d'appoint de 50x45 pour usage intérieur et extérieur. Structure en aluminium anodisé peint par pulvérisation au four de 40x40 mm et de 2 mm d'épaisseur. Sur 3 mm d'épaisseur. Contient unseau à glace en polycarbonate transparent noir.

Medidas | Measures | Measures

W 45cm x L 50cm x H 35,8cm
W 17,72in x L 19,69in x H 14,09in

Peso | Weight | Poids

5,06 kg

Logística | Logistics | Logistique

1X	-	480	-	540	-



* Sujeto a condiciones. Por favor, consultar.
* Subject to conditions. Please inquire.
* Sous réserve de conditions. Merci de consulter.



Mesa Bini

lounge

Designed by Joan Gaspar

NEW



Mesa Bini Lounge para uso interior y exterior. Fabricado en polipropileno con fibra de vidrio, con protección UV.

Bini Lounge table for indoor and outdoor use. Made of polypropylene with fiberglass, with UV protection.

Table Bini Lounge pour usage intérieur et extérieur. Fabriqué en polypropylène avec fibre de verre, avec protection UV.

Medidas | Measures | Mesures

Ø70cm x H 40cm
Ø27,56in x H 15,75in

Peso | Weight | Poids

5,5 kg

Logística | Logistics | Logistique



Toscano
Tuscan



Terracota
Terracotta



Marfil
Ivory



Arena
Sand



Gris Oscuro
Dark Grey



Gris Verdoso
Green Grey

Certificaciones | Certifications

UNEEN581-1, UNEEN581-2

	20'	40'	40' HC	70 m ³	100 m ³
1X	450	912	1056	1254	1360

Mesa Raff

Designed by Joan Gaspar



Mesa para uso interior y exterior. Inyectado con fibra de vidrio y PP. Protección UV.

Table for indoor and outdoor use. Injected with fiberglass and PP. UV protection.

Table pour un usage intérieur et extérieur. injecté avec PP et fibre de verre. Protection UV.

Medidas | Measures | Mesures

W 40cm x L 40cm x H 37cm
W 15,75in x L 15,75in x H 14,57in

Peso | Weight | Poids

1,5 kg

Logística | Logistics | Logistique



Toscano
Tuscan



Chocolate
Chocolate



Arena
Sand



Negro
Black



Blanco
White



Burdeos
Burgundy

Certificaciones | Certifications

UNEEN581-1, UNEEN581-3

	20'	40'	40' HC	70 m ³	100 m ³
4X	1352	2800	3308	3400	4760

Taburetes

Stools / Tabourets



Espiga

Designed by Jordi Ribaudí



Taburete alto con estructura patín en acero pintado. Cinta de polyester ignífuga e hidrófuga. Tacos antideslizantes. Tornillería de acero inoxidable.

High stool with a painted steel sled-base structure. Flame-retardant and water-repellent polyester strip. Anti-slip feet. Screws made of stainless steel.

Tabouret haut avec structure patin en acier peint. Bande de polyester ignifuge et hydrofuge. Embouts antidérapants. Visserie en acier inoxydable.

Medidas | Measures | Measures

W 53,5cm x L 58cm x H 100cm x Hs 82cm
W 21,06in x L 22,83in x H 39,37in x Hs 32,28in

Peso | Weight | Poids

7,54 kg

Logística | Logistics | Logistique

	20'	40'	40' HC	70 m ³	100 m ³
4X	65	130	143	156	-



Barcino

Designed by Joan Gaspar



Taburete apilable para uso interior y exterior. Estructura, asiento y respaldo de aluminio anodizado pintado por pulverización y secado al horno. Estructura de 30 x 30 mm y 2 mm de grosor. Asiento y respaldo de 4 mm de grosor.

Stackable stool for indoor and outdoor use. Powder coated anodized aluminium structure, seat and back. Structure of 30 x 30 mm and 2 mm thick. Seat and back of 4 mm thick.

Tabouret empilable pour usage intérieur et extérieur. Structure, siège et dossier en aluminium anodisé peints par pulvérisation et séchés au four. Structure de 30 x 30 mm et 2 mm de grosseur.

Medidas | Measures | Measures

W 36,7cm x L 39,3cm x H 99cm x Hs 77cm
W 14,45in x L 15,47in x H 38,98in x Hs 30,31in

Peso | Weight | Poids

4,8 kg

Apilado | Stackable | Empilable

4 unidades | units | unités

Logística | Logistics | Logistique

	20'	40'	40' HC	70 m ³	100 m ³
2X	256	528	592	768	814
4X	512	1056	1184	1536	1628



Certificaciones | Certifications

UNEEN581-1

Skin Patin

Fully upholstered

Designed by Josep Llusçà

NEW



Taburete tapizado integralmente. Carcasa inyectada en polipropileno con fibra de vidrio. Estructura de las patas en acero pintado.

Fully upholstered stool. Seat injected in polypropylene with fiberglass. Structure of painted steel.

Tabouret entièrement tapissé. Siège injectée en polypyrène avec fibre de verre, structure de acier peint.

Medidas | Measures | Measures

W 52cm x L 54,5cm x H 94,5cm x Hs 73cm
W 20,47in x L 21,46in x H 37,20in x Hs 28,74in

Peso | Weight | Poids

7,95 kg

Logística | Logistics | Logistique

	20'	40'	40' HC	70 m ³	100 m ³
1X	54	120	120	264	194

Ver opciones de tapizado en página 382.
See upholstery options on page 382.



Certificaciones | Certifications

UNEEN581-1, UNEEN581-2, UNEEN16139, UNEEN1728

Skin Pie Central

Fully upholstered

Designed by Josep Llusçà

NEW



Taburete tapizado integralmente. Carcasa inyectada en polipropileno con fibra de vidrio. Pie de acero pintado o cromado, con bomba.

Fully upholstered stool. Seat injected in polypropylene with fiberglass. Structure of painted steel or chromed steel, with pump.

Tabouret entièrement tapissé. Siège injectée en polopropylène avec fibre de verre, structure de acier peint ou de acier chromé, avec pump.

Medidas | Measures | Mesures

W 48cm x L 48cm x H 115cm x Hs 77cm
W 18,90in x L 18,90in x H 45,28in x Hs 30,31in

Peso | Weight | Poids

8,2 kg

Logística | Logistics | Logistique

	20'	40'	40 HC	70 m3	100 m3
1X	54	120	120	264	194

Ver opciones de tapizado en página 382. See upholstery options on page 382.

Skin Patin

Designed by Josep Llusçà



Taburete patín para uso interior. Carcasa inyectada en PP y fibra de vidrio. Estructura de acero cromado o pintado blanco.

Sled stool for indoor use. Seat injected in PP and Fibreglass. Chromed or white-painted steel structure.

Tabouret patin pour usage intérieur. Siège injecté en fibre de verre et PP. Structure en acier chromé ou peint blanc.

Medidas | Measures | Mesures

W 52cm x L 54,5cm x H 94,5cm x Hs 73cm
W 20,47in x L 21,46in x H 37,20in x Hs 28,74in

Peso | Weight | Poids

7,45 kg

Logística | Logistics | Logistique

	20'	40'	40 HC	70 m3	100 m3
2X	80	176	176	416	-
4X	180	352	352	416	-
8X	80	176	176	416	-



Certificaciones | Certifications

UNEEN581-1, UNEEN581-2, UNEEN16139 L1

Skin Patin

Upholstered seat pad

Designed by Josep Llusçà



Taburete patín para uso interior. Carcasa inyectada en PP y fibra de vidrio. Estructura de acero cromado opintado blanco. Asiento tapizado en tejido Spradling.

Sled stool for indoor use. Seat injected in PP and Fibreglass. Chromed or white-painted steel structure. Upholstered seat pad in Spradling fabric.

Tabouret patin pour usage intérieur. Siège injecté en fibre de verre et PP. Structure en acier chromé ou peint blanc. Siège tapissé avec Spradling tissu.

Medidas | Measures | Mesures

W 52cm x L 54,5cm x H 94,5cm x Hs 73cm
W 20,47in x L 21,46in x H 37,20in x Hs 28,74in

Peso | Weight | Poids

7,85 kg

Logística | Logistics | Logistique

	20'	40'	40 HC	70 m3	100 m3
2X	-	176	-	-	208



Certificaciones | Certifications

UNEEN581-1, UNEEN581-2, UNEEN16139 L1

res

Skin Pie Central

Designed by Josep Llusçà

Taburete pie central para uso interior. Carcasa inyectada en PP con fibra de vidrio. Estructura de acero cromado o pintado blanco.

Central base stool for indoor use. Seat injected in PP with fibreglass. Chrome-plated or white-painted steel structure.

Tabouret à base centrale pour une utilisation en intérieur. Assise injectée en PP avec fibre de verre. Structure en acier Chromé ou peint en blanc.



Medidas | Measures | Mesures

W 48cm x L 48cm x H 115cm x Hs 77cm
W 18,90in x L 18,90in x H 45,28in x Hs 30,31in

Peso | Weight | Poids

7,7 kg

Logística | Logistics | Logistique

	312	740	760	-	1640

Chocolate/Blanco Chocolate/White	Gris Oscuro/Blanco Dark Grey/White	Negro/Blanco Black/White	Blanco White
Chocolate/Cromado Chocolate/Chromed	Gris Oscuro/Cromado Dark Grey/Chromed	Negro/Cromado Negro/Chromed	Blanco/Cromado White/Chromed

Skin Pie Central

Upholstered seat pad

Designed by Josep Llusçà

Taburete pie central para uso interior. Carcasa inyectada en PP con fibra de vidrio. Estructura de acero cromado o pintado blanco. Asiento tapizado en tejido Spradling.

Central base stool for indoor use. Seat injected in PP with fibreglass. Chrome-plated or white-painted steel structure. Upholstered seat pad in Spradling fabric.

Tabouret à base centrale pour une utilisation en intérieur. Assise injectée en PP avec fibre de verre. Structure en acier Chromé ou peint en blanc. Siège tapissé avec Spradling tissu.



Medidas | Measures | Mesures

W 48cm x L 48cm x H 115cm x Hs 77cm
W 18,90in x L 18,90in x H 45,28in x Hs 30,31in

Peso | Weight | Poids

8,1 kg

		Structure			
Upholstered		Gris Oscuro Dark Grey	Chocolate Chocolate	Negro Black	Blanco White
Blanco White		●	●	●	●
Negro Black		●	●	●	●
Chocolate Chocolate		●	●	●	●
Arena Sand		●	●	●	●
Rojo Red		●	●	●	●
Nilo Nilo		●	●	●	●

Tapizado | Upholstered | Revêtement

SPRADLING®

Tapizados aptos para interiores y exteriores

Upholstered suitable for indoor and outdoor

Revêtement apte pour intérieur et extérieur.

Para evitar marcas, por favor no apile las sillas tapizadas.

In order to avoid marks, please do not stack upholstered chairs.

Pour éviter des marques, ne pas empiler les chaises tapissées.

Logística | Logistics | Logistique

	1X	-	1800	-	2160

Colores de Pie | Foot Colors | Couleurs des pieds

Cromado Chromed	Blanco White

Wire Patin

Designed by Josep Llusçà



Taburete patin para uso interior. Carcasa inyectada en fibra de vidrio y PP. Estructura de acero cromado o pintado blanco.

Sled stool for indoor use. Fibreglass and PP injected casing. Chrome-plated or white-painted steel structure.

Tabouret patin pour usage intérieur. Siège injecté en fibre de verre et PP. Structure en acier chromé ou peint blanc.

Medidas | Measures | Mesures

W 52cm x L 54,5cm x H 108,5cm x Hs 73cm
W 20,47in x L 21,46in x H 42,72in x Hs 28,74in

Peso | Weight | Poids

7,45 kg

Logística | Logistics | Logistique

	20'	40'	40 HC	70 m ³	100 m ³
2X	156	312	384	374	498
4X	312	624	768	748	996



Colores de Pie | Foot Colors | Couleurs des pieds



Wire Pie Central

Designed by Josep Llusçà



Taburete pie central para uso interior. Carcasa inyectada en PP con fibra de vidrio. Estructura de acero cromado o pintado blanco.

Central foot stool for indoor use. PP injected frame with fibreglass. Chrome-plated or white-painted steel structure.

Tabouret pied central pour intérieur. Siège injecté en PP et fibre de verre. Structure en acier chromé ou peint blanc.

Medidas | Measures | Mesures

W 48cm x L 48cm x H 115cm x Hs 77cm
W 18,90in x L 18,90in x H 45,28in x Hs 30,31in

Peso | Weight | Poids

7,7 kg

Logística | Logistics | Logistique

	20'	40'	40 HC	70 m ³	100 m ³
1X	156	344	392	432	536



Colores de Pie | Foot Colors | Couleurs des pieds



Woody Alto

Designed by Josep Llusçà



Green Edition

Taburete para uso interior y exterior. Inyectado en fibra de vidrio y PP 100% reciclados. Apilable. Protección UV.

Stool for indoor and outdoor use. Injected with fibreglass and PP 100% recycled. UV protection.

Tabouret d'intérieur et extérieur. Injecté avec fibre de verre et PP 100% recycle. Protection UV.

Medidas | Measures | Mesures

W 52,5cm x L 50cm x H 98,5cm x Hs 75,5cm
W 20,67in x L 19,69in x H 38,78in x Hs 29,72in

Peso | Weight | Poids Apilado | Stackable | Empilable

5,75 kg 6 unidades | units | unités

Logística | Logistics | Logistique

	20'	40'	40 HC	70 m ³	100 m ³
2X	176	352	352	440	520
4X	176	352	352	440	520
P22	176	352	352	440	520



Certificaciones | Certifications

UNEEN581-1, UNEEN581-2

* Sujeto a condiciones. Por favor, consultar.
* Subject to conditions. Please inquire.
* Sous réserve de conditions. Merci de consulter.

* Green Edition

Woody Alto

Designed by Josep Llusçà



Taburete para uso interior y exterior. Fabricado en polipropileno con fibra de vidrio. Protección UV.

Stool for indoor and outdoor use. Made from polypropylene with fibreglass. UV protection.

Tabouret pour usage intérieur et extérieur. Fabriqué en polypropylène et fibre de verre. Protection UV.

Medidas | Measures | Mesures

W 52,5cm x L 50cm x H 98,5cm x Hs 75,5cm
W 20,67in x L 19,69in x H 38,78in x Hs 29,72in

Peso | Weight | Poids Apilado | Stackable | Empilable

5,75 kg 6 unidades | units | unités

Logística | Logistics | Logistique

	20'	40'	40' HC	70 m ³	100 m ³
2X	176	352	352	440	520
4X	176	352	352	440	520
P22	176	352	352	440	520



Certificaciones | Certifications

UNEEN581-1, UNEEN581-2

Woody Medio

Designed by Josep Llusçà



Taburete para uso interior y exterior. Fabricado en polipropileno con fibra de vidrio. Protección UV.

Stool for indoor and outdoor use. Made from polypropylene with fibreglass. UV protection.

Tabouret pour usage intérieur et extérieur. Fabriqué en polypropylène et fibre de verre. Protection UV.

Medidas | Measures | Mesures

W 52,5cm x L 49cm x H 88,5cm x Hs 65,5cm
W 20,67in x L 19,29in x H 34,84in x Hs 25,79in

Peso | Weight | Poids Apilado | Stackable | Empilable

6,11 kg 6 unidades | units | unités

Logística | Logistics | Logistique

	20'	40'	40' HC	70 m ³	100 m ³
2X	176	352	352	440	520
4X	284	592	616	768	848
P24	576	1152	1152	1272	1344



Certificaciones | Certifications

NFEN581-1, UNEN16139

Woody Alto

Upholstered seat pad

Designed by Josep Llusçà



Taburete para uso interior y exterior. Fabricado en polipropileno con fibra de vidrio. Protección UV. Con espuma de secado rápido. Tapizados aptos para interiores y exteriores. Gramaje 275 gr/m²

Stool for indoor and outdoor use. Made from polypropylene with fibreglass. UV protection. With quick-drying foam. Upholstery suitable for indoor and outdoor use. Grammage 275 gr/m²

Tabouret pour usage intérieur et extérieur. Fabriqué en polypropylène et fibre de verre. Protection UV. Avec mousse à séchage rapide. Tapissés adaptés à l'intérieur et l'extérieur. Grammage 275 gr/m²

Medidas | Measures | Mesures

W 52,5cm x L 50cm x H 98,5cm x Hs 75,5cm
W 20,67in x L 19,69in x H 38,78in x Hs 29,72in

Peso | Weight | Poids Apilado | Stackable | Empilable

5,75 kg 6 unidades | units | unités

Logística | Logistics | Logistique

	20'	40'	40' HC	70 m ³	100 m ³
2X	176	352	352	440	520
4X	284	592	616	768	848



Certificaciones | Certifications

UNEEN581-1, UNEEN581-2, UNEN16139

Woody Medio

Upholstered seat pad

Designed by Josep Llusca



Taburete para uso interior y exterior. Fabricado en polipropileno con fibra de vidrio. Protección UV. Con espuma de secado rápido. Tapizados aptos para interiores y exteriores. Gramaje 275 gr/m2

Stool for indoor and outdoor use. Made from polypropylene with fibreglass. UV protection. With quick-drying foam. Upholstery suitable for indoor and outdoor use. Grammage 275 gr/m2

Tabouret pour usage intérieur et extérieur. Fabriqué en polypropylène et fibre de verre. Protection UV. Avec mousse à séchage rapide. Tapissés adaptés à l'intérieur et l'extérieur. Grammage 275 gr/m2

Medidas | Measures | Mesures

W 52,5cm x L 49cm x H 88,5cm x Hs 66,5cm
W 20,67in x L 19,29in x H 34,84in x Hs 26,18in

Peso | Weight | Poids

6,11 kg

Certificaciones | Certifications

UNEN16139, UNEEN581-1, UNEEN581-2

Tapizado | Upholstered | Revêtement



Con espuma de secado rápido

With quick dry foam
Mousse à séchage rapide.

Tapizados aptos para interiores y exteriores

Upholstered suitable for indoor and outdoor
Revêtement apte pour intérieur et extérieur.

Gramaje | Grammage | Grammage

275 gr / m2

Para evitar marcas, por favor no apile las sillas tapizadas.

In order to avoid marks, please do not stack upholstered chairs.
Pour éviter des marques, ne pas empiler les chaises tapissées.

	Structure	Rojo Red	Arena Sand	Azul Retro Retro Blue	Marfil Ivory	Gris Verdoso Green Grey	Chocolate Chocolate	Gris Oscuro Dark Grey	Negro Black
Upholstered									
Carbón Coal		•		•				•	•
Lino Linen		•	•	•	•	•	•	•	•
Taupe Taupe			•		•	•	•		•
Calabaza Pumpkin			•		•		•	•	•

Logística | Logistics | Logistique

		20'	40'	40 HC	70 m3	100 m3
2X	176	352	352	440	520	
4X	176	352	352	440	520	

Lisboa Alto

Designed by Joan Gaspar



Taburete para uso interior y exterior. Inyectado en fibra de vidrio con PP mediant tecnología de moldeo asistida por gas. Protección UV.

Stool for indoor and outdoor use. Injected with fiberglass and PP using gas assisted injection moulding technology. UV protection.

Tabouret d'intérieur et extérieur. Injectée avec fibre de verre et PP, en utilisant technologie de moulage assistée par gaz. Protection UV.

Medidas | Measures | Measures

W 42,3cm x L 44,1cm x H 102,2cm x Hs 77cm
W 16,65in x L 17,36in x H 40,24in x Hs 30,31in

Peso | Weight | Poids

4,09 kg

Logística | Logistics | Logistique

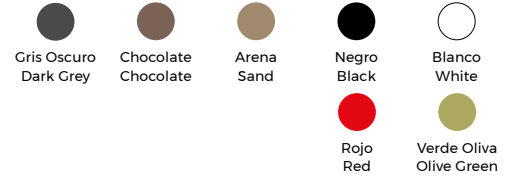

	20'	40'	40' HC	70 m ³	100 m ³
2X	246	520	592	632	652
4X	352	720	720	960	1088

Certificaciones | Certifications

UNEEN581-1, UNEEN581-2, UNEN16139

Lisboa Medio

Designed by Joan Gaspar



Taburete para uso interior y exterior. Inyectado en fibra de vidrio con PP mediant tecnología de moldeo asistida por gas. Protección UV. Peso neto 4,09 kg, 3,83 kg, 2,90 kg.

Stool for indoor and outdoor use. Injected with fiberglass and PP using gas assisted injection moulding technology. UV protection.

Tabouret d'intérieur et extérieur. Injectée avec fibre de verre et PP, en utilisant technologie de moulage assistée par gaz. Protection UV.

Medidas | Measures | Measures

W 41,6cm x L 43,6cm x H 92,2cm x Hs 67cm
W 16,38in x L 17,17in x H 36,30in x Hs 26,38in

Peso | Weight | Poids

3,83 kg

Logística | Logistics | Logistique

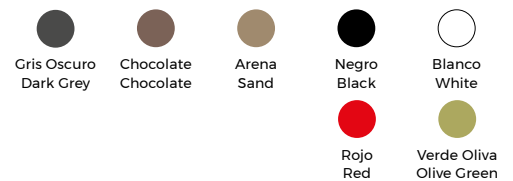

	20'	40'	40' HC	70 m ³	100 m ³
2X	246	520	592	632	652
4X	492	1040	1184	1264	1034

Certificaciones | Certifications

UNEEN581-1, UNEEN581-2, UNEN16139

Bancadas

Bench / Banc



Shape 2 + mesa

Designed by Josep Llusçà

Bancada para interior con estructura en acero pintado en blanco o negro, asientos de inyección de PP con fibra de vidrio, mesa auxiliar de HPL en color blanco.

Indoor bench made of painted steel structure in black or white, seats made of injected PP with fiberglass, white HPL side table.

Banc d'intérieur avec structure en acier peint en blanc ou noir, sièges en injection PP avec fibre de verre, table auxiliaire en HPL blanc.



Medidas | Measures | Measures

W 192cm x L 55,1cm x H 81cm x Hs 43cm
W 75,59in x L 21,69in x H 31,89in x Hs 16,93in

Peso | Weight | Poids

45 kg

Logística | Logistics | Logistique

	20'	40'	40' HC	70 m ³	100 m ³
1X	120	240	290	320	400

Estructura | Structure



Asiento | Seat | Siège



Shape 3

Designed by Josep Llusçà

Bancada para interior con estructura en acero pintado en blanco o negro, asientos de inyección de PP con fibra de vidrio.

Indoor bench made of painted steel structure in black or white, seats made of injected PP with fiberglass.

Banc d'intérieur avec structure en acier peint en blanc ou noir, sièges en injection PP avec fibre de verre.

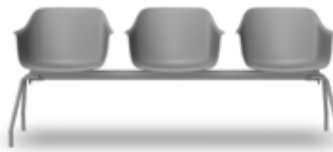

Medidas | Measures | Measures

W 192cm x L 55,1cm x H 81cm x Hs 43cm
W 75,59in x L 21,69in x H 31,89in x Hs 16,93in

Peso | Weight | Poids

42 kg

Logística | Logistics | Logistique

	20'	40'	40' HC	70 m ³	100 m ³
1X	120	240	290	320	400

Estructura | Structure



Asiento | Seat | Siège



Shape 3 + mesa

Designed by Josep Llusçà

Bancada para interior con estructura en acero pintado en blanco o negro, asientos de inyección de PP con fibra de vidrio, mesa auxiliar de HPL en color blanco.

Indoor bench made of painted steel structure in black or white, seats made of injected PP with fiberglass, white HPL side table.

Banc d'intérieur avec structure en acier peint en blanc ou noir, sièges en injection PP avec fibre de verre, table auxiliaire en HPL blanc.



Medidas | Measures | Measures

W 258cm x L 55,1cm x H 81cm x Hs 43cm
W 101,57in x L 21,69in x H 31,89in x Hs 16,93in

Peso | Weight | Poids

48 kg

Logística | Logistics | Logistique

	20'	40'	40' HC	70 m ³	100 m ³
1X	105	230	260	300	380

Estructura | Structure

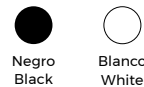

Asiento | Seat | Siège



Bancadas | Bench | Banc

Shape 4

Seat pad upholstered

Designed by Josep Llusçà



Bancada para interior con estructura en acero pintado en blanco o negro, asientos de inyección de PP con fibra de vidrio.

Indoor bench made of painted steel structure in black or white, seats made of injected PP with fiberglass.

Banc d'intérieur avec structure en acier peint en blanc ou noir, sièges en injection PP avec fibre de verre.

Medidas | Measures | Mesures

W 258cm x L 55,1cm x H 81cm x Hs 43cm

W 101,57in x L 21,69in x H 31,89in x Hs 16,93in

Peso | Weight | Poids

45 kg

Estructura | Structure



Negro
Black



Blanco
White

Upholstered	Structure	●	●	●	●*	●*	○*
		Gris Oscuro Dark Grey	Toscano Tuscan	Arena Sand	Gris Verdoso Green Grey	Azul Retro Retro Blue	Blanco White
Carbón Coal		●	●	●	●	●	●
Lino Linen		●	●	●	●	●	●
Taupe Taupe		●		●	●	●	●
Mimosa Mimosa		●	●				●
Azul mineral Mineral Blue		●					●

Tapizado | Upholstered | Revêtement



Con espuma de secado rápido

With quick dry foam

Mousse à séchage rapide.

Tapizados aptos para interiores y exteriores

Upholstered suitable for indoor and outdoor

Revêtement apte pour intérieur et extérieur.

Gramaje | Grammage | Grammage

275 gr / m2

Logística | Logistics | Logistique

1X	105	230	260	300	380



* Sujeto a condiciones. Por favor, consultar.
* Subject to conditions. Please inquire.
* Sous réserve de conditions. Merci de consulter.



* Green Edition

Angie 2 + Mesa

Designed by Josep Llusçà

Bancada para interior con estructura en acero pintado en blanco o negro, asientos de inyección de PP con fibra de vidrio, mesa auxiliar de HPL en color blanco.

Indoor bench made of painted steel structure in black or white, seats made of injected PP with fiberglass, white HPL side table.

Banc d'intérieur avec structure en acier peint en blanc ou noir, sièges en injection PP avec fibre de verre, table auxiliaire en HPL blanc.



Medidas | Measures | Mesures

W 192cm x L 55,1cm x H 81cm x Hs 43cm
W 75,59in x L 21,69in x H 31,89in x Hs 16,93in

Peso | Weight | Poids

45 kg

Estructura | Structure



Negro
Black



Blanco
White

Asiento | Seat | Siège



Gris Cachemira
Cashmere Grey



Chocolate
Chocolate



Blanco
White



Verde Oliva
Olive Green



Arena
Sand

Logística | Logistics | Logistique

1X	120	240	290	320	400

Angie 3

Designed by Josep Llusçà

Bancada para interior con estructura en acero pintado en blanco o negro, asientos de inyección de PP con fibra de vidrio, mesa auxiliar de HPL en color blanco.

Indoor bench made of painted steel structure in black or white, seats made of injected PP with fiberglass.

Banc d'intérieur avec structure en acier peint en blanc ou noir, sièges en injection PP avec fibre de verre.



Medidas | Measures | Mesures

W 192cm x L 55,1cm x H 81cm x Hs 43cm
W 75,59in x L 21,69in x H 31,89in x Hs 16,93in

Peso | Weight | Poids

45 kg

Estructura | Structure



Negro
Black



Blanco
White

Asiento | Seat | Siège



Gris Cachemira
Cashmere Grey



Chocolate
Chocolate



Blanco
White



Verde Oliva
Olive Green



Arena
Sand

Logística | Logistics | Logistique

1X	120	240	290	320	400

Angie 3 + Mesa

Designed by Josep Llusçà

Bancada para interior con estructura en acero pintado en blanco o negro, asientos de inyección de PP con fibra de vidrio, mesa auxiliar de HPL en color blanco.

Indoor bench made of painted steel structure in black or white, seats made of injected PP with fiberglass, white HPL side table.

Banc d'intérieur avec structure en acier peint en blanc ou noir, sièges en injection PP avec fibre de verre, table auxiliaire en HPL blanc.



Medidas | Measures | Mesures

W 258cm x L 55,1cm x H 81cm x Hs 43cm
W 101,57in x L 21,69in x H 31,89in x Hs 16,93in

Peso | Weight | Poids

48 kg

Estructura | Structure



Negro
Black



Blanco
White

Asiento | Seat | Siège



Gris Cachemira
Cashmere Grey



Chocolate
Chocolate



Blanco
White



Verde Oliva
Olive Green



Arena
Sand

Logística | Logistics | Logistique

1X	105	230	260	300	380

Bancadas | Bench | Banc

Angie 4

Seat pad upholstered

Designed by Josep Llusçà



Tapizado apto para interiores con tejido FIDIVI JET de 100% Polyester Trevira CS. Gramaje 260 g/m².

Upholstery suitable for indoor use with 100% Polyester Trevira CS FIDIVI JET fabric. Weight 260 g/m².

Tapissé adapté à une utilisation en intérieur avec tissu FIDIVI JET 100% Polyester Trevira CS. Poids 260 g/m².

Medidas | Measures | Mesures

W 258cm x L 55,1cm x H 81cm x Hs 43cm
W 101,57in x L 21,69in x H 31,89in x Hs 16,93in

Peso | Weight | Poids

48 kg

Estructura | Structure



Negro
Black



Blanco
White

Tapizado | Upholstered | Revêtement



Gramaje | Grammage | Grammage

260 gr / m2

Upholstered	Structure	Verde Oliva Olive Green	Arena Sand	Gris Cachemira	Chocolate Chocolate	Blanco White
		Jet 8033	●	●	●	●
Jet 6007	●	●	●	●	●	
Jet 3019	●	●	●	●	●	
Jet 7041	●	●	●	●	●	
Jet 9404	●	●	●	●	●	
Jet 1006	●	●	●	●	●	
Jet 9109	●	●	●	●	●	
Jet 2012	●	●	●	●	●	

Logística | Logistics | Logistique

	20'	40'	40 HC	70 m3	100 m3
1X	105	230	260	300	380



* Sujeto a condiciones. Por favor, consultar.
* Subject to conditions. Please inquire.
* Sous réserve de conditions. Merci de consulter.



Skin 2 + Mesa

Designed by Josep Llusçà

Bancada para interior con estructura en acero pintado en blanco o negro, asientos de inyección de PP con fibra de vidrio, mesa auxiliar de HPL en color blanco.

Indoor bench made of painted steel structure in black or white, seats made of injected PP with fiberglass, white HPL side table.

Banc d'intérieur avec structure en acier peint en blanc ou noir, sièges en injection PP avec fibre de verre, table auxiliaire en HPL blanc.



Medidas | Measures | Mesures

W 175,4cm x L 54,14cm x H 77,6cm x Hs 46,3cm
W 69,06in x L 21,31in x H 30,55in x Hs 18,23in

Peso | Weight | Poids

19,28 kg

Estructura | Structure



Negro
Black



Blanco
White

Asiento | Seat | Siège



Gris Oscuro
Dark Grey



Negro
Black



Blanco
White



Chocolate
Chocolate

Logística | Logistics | Logistique

	20'	40'	40' HC	70 m ³	100 m ³
1X	-	152	-	218	-

Skin 3

Designed by Josep Llusçà

Bancada para interior con estructura en acero pintado en blanco o negro, asientos de inyección de PP con fibra de vidrio, mesa auxiliar de HPL en color blanco.

Indoor bench made of painted steel structure in black or white, seats made of injected PP with fiberglass, white HPL side table.

Banc d'intérieur avec structure en acier peint en blanc ou noir, sièges en injection PP avec fibre de verre, table auxiliaire en HPL blanc.



Medidas | Measures | Mesures

W 175,36cm x L 54,14cm x H 77,6cm x Hs 46,3cm
W 69,04in x L 21,31in x H 30,55in x Hs 18,23in

Peso | Weight | Poids

22,75 kg

Estructura | Structure



Negro
Black



Blanco
White

Asiento | Seat | Siège



Gris Oscuro
Dark Grey



Negro
Black



Blanco
White



Chocolate
Chocolate

Logística | Logistics | Logistique

	20'	40'	40' HC	70 m ³	100 m ³
1X	-	152	-	218	-

Skin 3 + Mesa

Designed by Josep Llusçà

Bancada para interior con estructura en acero pintado en blanco o negro, asientos de inyección de PP con fibra de vidrio, mesa auxiliar de HPL en color blanco.

Indoor bench made of painted steel structure in black or white, seats made of injected PP with fiberglass, white HPL side table.

Banc d'intérieur avec structure en acier peint en blanc ou noir, sièges en injection PP avec fibre de verre, table auxiliaire en HPL blanc.



Medidas | Measures | Mesures

W 232cm x L 54,14cm x H 77,6cm x Hs 46,3cm
W 91,34in x L 21,31in x H 30,55in x Hs 18,23in

Peso | Weight | Poids

27,21 kg

Estructura | Structure



Negro
Black



Blanco
White

Asiento | Seat | Siège



Gris Oscuro
Dark Grey



Negro
Black



Blanco
White



Chocolate
Chocolate

Logística | Logistics | Logistique

	20'	40'	40' HC	70 m ³	100 m ³
1X	-	152	-	218	-

Skin 4

Designed by Josep Llusçà

Bancada para interior con estructura en acero pintado en blanco o negro, asientos de inyección de PP con fibra de vidrio, mesa auxiliar de HPL en color blanco.

Indoor bench made of painted steel structure in black or white, seats made of injected PP with fiberglass, white HPL side table.

Banc d'intérieur avec structure en acier peint en blanc ou noir, sièges en injection PP avec fibre de verre, table auxiliaire en HPL blanc.



Medidas | Measures | Mesures

W 232cm x L 54,14cm x H 77,6cm x Hs 46,3cm
W 91,34in x L 21,31in x H 30,55in x Hs 18,23in

Peso | Weight | Poids

28,54 kg

Estructura | Structure



Negro
Black



Blanco
White

Asiento | Seat | Siège



Gris Oscuro
Dark Grey



Negro
Black



Blanco
White



Chocolate
Chocolate

Logística | Logistics | Logistique

	20'	40'	40' HC	70 m ³	100 m ³
1X	-	152	-	218	-

Skin 2 + Mesa armchair

Designed by Josep Llusçà

Bancada para interior con estructura en acero pintado en blanco o negro, asientos de inyección de PP con fibra de vidrio, mesa auxiliar de HPL en color blanco.

Indoor bench made of painted steel structure in black or white, seats made of injected PP with fiberglass, white HPL side table.

Banc d'intérieur avec structure en acier peint en blanc ou noir, sièges en injection PP avec fibre de verre, table auxiliaire en HPL blanc.



Medidas | Measures | Mesures

W 175,4cm x L 54,14cm x H 77,6cm x Hs 46,3cm
W 69,06in x L 21,31in x H 30,55in x Hs 18,23in

Peso | Weight | Poids

20,28 kg

Estructura | Structure



Negro
Black



Blanco
White

Asiento | Seat | Siège



Gris Oscuro
Dark Grey



Negro
Black



Blanco
White



Chocolate
Chocolate

Logística | Logistics | Logistique

	20'	40'	40' HC	70 m ³	100 m ³
1X	-	152	-	218	-

Skin 3 armchair

Designed by Josep Llusçà

Bancada para interior con estructura en acero pintado en blanco o negro, asientos de inyección de PP con fibra de vidrio, mesa auxiliar de HPL en color blanco.

Indoor bench made of painted steel structure in black or white, seats made of injected PP with fiberglass, white HPL side table.

Banc d'intérieur avec structure en acier peint en blanc ou noir, sièges en injection PP avec fibre de verre, table auxiliaire en HPL blanc.



Medidas | Measures | Mesures

W 175,36cm x L 54,14cm x H 77,6cm x Hs 46,3cm
W 69,04in x L 21,31in x H 30,55in x Hs 18,23in

Peso | Weight | Poids

23,75 kg

Estructura | Structure



Negro
Black



Blanco
White

Asiento | Seat | Siège



Gris Oscuro
Dark Grey



Negro
Black



Blanco
White



Chocolate
Chocolate

Logística | Logistics | Logistique

	20'	40'	40' HC	70 m ³	100 m ³
1X	-	152	-	218	-



Skin 3 + Mesa

armchair

Designed by Josep Llusçà

Bancada para interior con estructura en acero pintado en blanco o negro, asientos de inyección de PP con fibra de vidrio, mesa auxiliar de HPL en color blanco.

Indoor bench made of painted steel structure in black or white, seats made of injected PP with fiberglass, white HPL side table.

Banc d'intérieur avec structure en acier peint en blanc ou noir, sièges en injection PP avec fibre de verre, table auxiliaire en HPL blanc.



Medidas | Measures | Mesures

W 232cm x L 54,14cm x H 77,6cm x Hs 46,3cm
W 91,34in x L 21,31in x H 30,55in x Hs 18,23in

Peso | Weight | Poids

28,21 kg

Logística | Logistics | Logistique

	20'	40'	40' HC	70 m ³	100 m ³
1X	-	152	-	218	-

Estructura | Structure

● Negro
Black

○ Blanco
White

Asiento | Seat | Siège

● Gris Oscuro
Dark Grey

● Negro
Black

○ Blanco
White

● Chocolate
Chocolate

Skin 4

armchair

Designed by Josep Llusçà

Bancada para interior con estructura en acero pintado en blanco o negro, asientos de inyección de PP con fibra de vidrio, mesa auxiliar de HPL en color blanco.

Indoor bench made of painted steel structure in black or white, seats made of injected PP with fiberglass, white HPL side table.

Banc d'intérieur avec structure en acier peint en blanc ou noir, sièges en injection PP avec fibre de verre, table auxiliaire en HPL blanc.



Medidas | Measures | Mesures

W 232cm x L 54,14cm x H 77,6cm x Hs 46,3cm
W 91,34in x L 21,31in x H 30,55in x Hs 18,23in

Peso | Weight | Poids

29,54 kg

Logística | Logistics | Logistique

	20'	40'	40' HC	70 m ³	100 m ³
1X	-	152	-	218	-

Estructura | Structure

● Negro
Black

○ Blanco
White

Tapizado | Upholstered | Revêtement

SPRADLING®

Tapizados aptos para interiores y exteriores

Upholstered suitable for indoor and outdoor

Revêtement apte pour intérieur et extérieur.

Upholstered	Structure	● Gris Oscuro Dark Grey	○ Blanco White	● Chocolate Chocolate	● Negro Black
		Blanco White	●	●	●
Negro Black	●	●	●	●	
Chocolate Chocolate	●	●	●	●	
Arena Sand	●	●	●	●	
Rojo Red	●	●	●	●	
Nilo Nilo	●	●	●	●	

Logística | Logistics | Logistique

	20'	40'	40' HC	70 m ³	100 m ³
1X	-	152	-	218	-

Sets / Sillones y sofás

Sets / Armchairs and sofas

Sets / Fauteuils et canapés



Anthea Sofa System A

Designed by Monica Armani

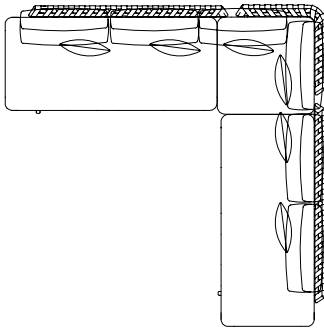

Composición sofá con estructura de aluminio lacada, cojines y tapizados idóneos para el exterior. Respaldo en cinta de pasamanería trenzada sobre tubo de aluminio. Amplia gama cromática y combinaciones para escoger entre cojines opcionales.

Sofa system with lacquered aluminium structure, cushions and upholstery suitable for outdoor use, and backrest in braided trimming tape on aluminium tube. Wide range of colours and combinations to choose from the optional cushions.

Système de canapés avec structure en aluminium laqué, coussins et tapissés parfaits pour l'extérieur, et dossier en ruban de passementerie tressée sur des tubes en aluminium. Vaste gamme de couleur et combinaisons à choisir parmi les couleurs en option.

Medidas | Measures | Measures

W 259cm x L 259cm x H 60cm x Hs 37,5cm
W 101,97in x L 101,97in x H 23,62in x Hs 14,76in

Peso | Weight | Poids

86,7 kg

Logística | Logistics | Logistique

	20'	40'	40' HC	70 m ³	100 m ³
1X	12	28	28	-	32



Ver combinaciones de colores en página 447.
See color combinations on page 447.

Anthea Sofa System B

Designed by Monica Armani

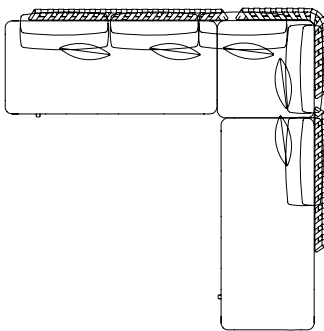

Composición sofá con estructura de aluminio lacada, cojines y tapizados idóneos para el exterior. Respaldo en cinta de pasamanería trenzada sobre tubo de aluminio. Amplia gama cromática y combinaciones para escoger entre cojines opcionales.

Sofa system with lacquered aluminium structure, cushions and upholstery suitable for outdoor use, and backrest in braided trimming tape on aluminium tube. Wide range of colours and combinations to choose from the optional cushions.

Système de canapés avec structure en aluminium laqué, coussins et tapissés parfaits pour l'extérieur, et dossier en ruban de passementerie tressée sur des tubes en aluminium. Vaste gamme de couleur et combinaisons à choisir parmi les couleurs en option.

Medidas | Measures | Measures

W 259cm x L 259cm x H 60cm x Hs 37,5cm
W 101,97in x L 101,97in x H 23,62in x Hs 14,76in

Peso | Weight | Poids

83,9 kg

Logística | Logistics | Logistique

	20'	40'	40' HC	70 m ³	100 m ³
1X	12	28	28	-	32



Ver combinaciones de colores en página 447.
See color combinations on page 447.

Anthea Sofa System C

Designed by Monica Armani

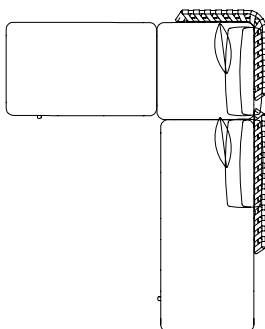

Composición sofá con estructura de aluminio lacada, cojines y tapizados idóneos para el exterior. Respaldo en cinta de pasamanería trenzada sobre tubo de aluminio. Amplia gama cromática y combinaciones para escoger entre cojines opcionales.

Sofa system with lacquered aluminium structure, cushions and upholstery suitable for outdoor use, and backrest in braided trimming tape on aluminium tube. Wide range of colours and combinations to choose from the optional cushions.

Système de canapés avec structure en aluminium laqué, coussins et tapissés parfaits pour l'extérieur, et dossier en ruban de passementerie tressée sur des tubes en aluminium. Vaste gamme de couleur et combinaisons à choisir parmi les couleurs en option.

Medidas | Measures | Measures

W 60cm x L 259cm x H 259cm x Hs 37,5cm
W 23,62in x L 101,97in x H 101,97in x Hs 14,76in

Peso | Weight | Poids

72,1 kg

Logística | Logistics | Logistique

	20'	40'	40' HC	70 m ³	100 m ³
1X	6	14	14	-	15

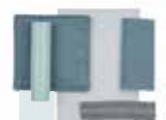

Ver combinaciones de colores en página 447.
See color combinations on page 447.

Anthea Sofa System D

Designed by Monica Armani

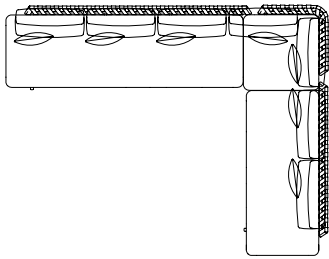

Composición sofá con estructura de aluminio lacada, cojines y tapizados idóneos para el exterior. Respaldo en cinta de pasamanería trenzada sobre tubo de aluminio. Amplia gama cromática y combinaciones para escoger entre cojines opcionales.

Sofa system with lacquered aluminium structure, cushions and upholstery suitable for outdoor use, and backrest in braided trimming tape on aluminium tube. Wide range of colours and combinations to choose from the optional cushions.

Système de canapés avec structure en aluminium laqué, coussins et tapissés parfaits pour l'extérieur, et dossier en ruban de passementerie tressée sur des tubes en aluminium. Vaste gamme de couleur et combinaisons à choisir parmi les couleurs en option.

Medidas | Measures | Measures

W 260cm x L 335cm x H 60cm x Hs 37,5cm
W 102,36in x L 131,89in x H 23,62in x Hs 14,76in

Peso | Weight | Poids

97,3 kg

Logística | Logistics | Logistique

	20'	40'	40' HC	70 m ³	100 m ³
1X	4	8	8	-	10



Ver combinaciones de colores en página 447.
See color combinations on page 447.

Anthea Sofa System E

Designed by Monica Armani

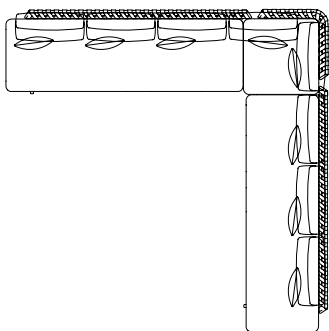

Composición sofá con estructura de aluminio lacada, cojines y tapizados idóneos para el exterior. Respaldo en cinta de pasamanería trenzada sobre tubo de aluminio. Amplia gama cromática y combinaciones para escoger entre cojines opcionales.

Sofa system with lacquered aluminium structure, cushions and upholstery suitable for outdoor use, and backrest in braided trimming tape on aluminium tube. Wide range of colours and combinations to choose from the optional cushions.

Système de canapés avec structure en aluminium laqué, coussins et tapissés parfaits pour l'extérieur, et dossier en ruban de passementerie tressée sur des tubes en aluminium. Vaste gamme de couleur et combinaisons à choisir parmi les couleurs en option.

Medidas | Measures | Measures

W 335cm x L 335cm x H 60cm x Hs 37,5cm
W 131,89in x L 131,89in x H 23,62in x Hs 14,76in

Peso | Weight | Poids

107,8 kg

Logística | Logistics | Logistique

	20'	40'	40' HC	70 m ³	100 m ³
1X	8	16	16	-	20



Ver combinaciones de colores en página 447.
See color combinations on page 447.

Anthea Sofa System F

Designed by Monica Armani

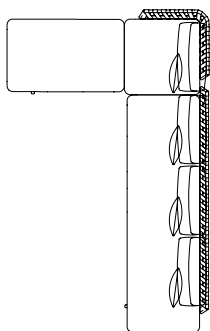

Composición sofá con estructura de aluminio lacada, cojines y tapizados idóneos para el exterior. Respaldo en cinta de pasamanería trenzada sobre tubo de aluminio. Amplia gama cromática y combinaciones para escoger entre cojines opcionales.

Sofa system with lacquered aluminium structure, cushions and upholstery suitable for outdoor use, and backrest in braided trimming tape on aluminium tube. Wide range of colours and combinations to choose from the optional cushions.

Système de canapés avec structure en aluminium laqué, coussins et tapissés parfaits pour l'extérieur, et dossier en ruban de passementerie tressée sur des tubes en aluminium. Vaste gamme de couleur et combinaisons à choisir parmi les couleurs en option.

Medidas | Measures | Measures

W 210cm x L 335cm x H 60cm x Hs 37,5cm
W 82,68in x L 131,89in x H 23,62in x Hs 14,76in

Peso | Weight | Poids

85,4 kg

Logística | Logistics | Logistique

	20'	40'	40' HC	70 m ³	100 m ³
1X	4	8	8	-	10



Ver combinaciones de colores en página 447.
See color combinations on page 447.

Anthea Sofa System G

Designed by Monica Armani

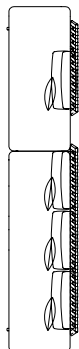

Composición sofá con estructura de aluminio lacada, cojines y tapizados idóneos para el exterior. Respaldo en cinta de pasamanería trenzada sobre tubo de aluminio. Amplia gama cromática y combinaciones para escoger entre cojines opcionales.

Sofa system with lacquered aluminium structure, cushions and upholstery suitable for outdoor use, and backrest in braided trimming tape on aluminium tube. Wide range of colours and combinations to choose from the optional cushions.

Système de canapés avec structure en aluminium laqué, coussins et tapissés parfaits pour l'extérieur, et dossier en ruban de passementerie tressée sur des tubes en aluminium. Vaste gamme de couleur et combinaisons à choisir parmi les couleurs en option.

Medidas | Measures | Mesures

W 87cm x L 425cm x H 60cm x Hs 37,5cm
W 34,25in x L 167,32in x H 23,62in x Hs 14,76in

Peso | Weight | Poids

71 kg

Logística | Logistics | Logistique

1X	8	16	16	-	20



Ver combinaciones de colores en página 447.
See color combinations on page 447.

Anthea Sofa System H

Designed by Monica Armani

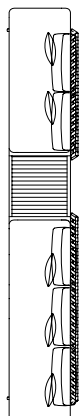

Composición sofá con estructura de aluminio lacada, cojines y tapizados idóneos para el exterior. Respaldo en cinta de pasamanería trenzada sobre tubo de aluminio. Amplia gama cromática y combinaciones para escoger entre cojines opcionales.

Sofa system with lacquered aluminium structure, cushions and upholstery suitable for outdoor use, and backrest in braided trimming tape on aluminium tube. Wide range of colours and combinations to choose from the optional cushions.

Système de canapés avec structure en aluminium laqué, coussins et tapissés parfaits pour l'extérieur, et dossier en ruban de passementerie tressée sur des tubes en aluminium. Vaste gamme de couleur et combinaisons à choisir parmi les couleurs en option.

Medidas | Measures | Mesures

W 87cm x L 500cm x H 60cm x Hs 37,5cm
W 34,25in x L 196,85in x H 23,62in x Hs 14,76in

Peso | Weight | Poids

94,1 kg

Logística | Logistics | Logistique

1X	4	8	8	-	10



Ver combinaciones de colores en página 447.
See color combinations on page 447.

Anthea Sofa 2 Plazas

Designed by Monica Armani



Sofá de 2 plazas con estructura de aluminio lacada, cojines y tapizados idóneos para el exterior, y respaldo en cinta de pasamanería trenzada sobre tubo de aluminio. Amplia gama cromática y combinaciones para escoger entre cojines opcionales.

Two-seater sofa with lacquered aluminium structure, cushions and upholstery suitable for outdoor use, and backrest in braided trimming tape on aluminium tube. Wide range of colours and combinations to choose from the optional cushions.

Sofa 2 places avec structure en aluminium laqué, coussins et tapissés parfaits pour l'extérieur, et dossier en ruban de passementerie tressée sur des tubes en aluminium. Vaste gamme de couleur et combinaisons à choisir parmi les couleurs en option.

Medidas | Measures | Mesures

W 199cm x L 87cm x H 60cm x Hs 37,5cm
W 78,35in x L 34,25in x H 23,62in x Hs 14,76in

Peso | Weight | Poids

38 kg

Logística | Logistics | Logistique

1X	50	65	78	-	96



Ver combinaciones de colores en página 447.
See color combinations on page 447.

Anthea Sofa

3 Plazas

Designed by Monica Armani



Sofá de 2 plazas con estructura de aluminio lacada, cojines y tapizados idóneos para el exterior, y respaldo en cinta de pasamanería trenzada sobre tubo de aluminio. Amplia gama cromática y combinaciones para escoger entre cojines opcionales.

Two-seater sofa with lacquered aluminium structure, cushions and upholstery suitable for outdoor use, and backrest in braided trimming tape on aluminium tube. Wide range of colours and combinations to choose from the optional cushions.

Sofa 2 places avec structure en aluminium laqué, coussins et tapissés parfaits pour l'extérieur, et dossier en ruban de passementerie tressée sur des tubes en aluminium. Vaste gamme de couleur et combinaisons à choisir parmi les couleurs en option.

Medidas | Measures | Measures

W 274cm x L 87cm x H 60cm x Hs 37,5cm
W 107,87in x L 34,25in x H 23,62in x Hs 14,76in

Peso | Weight | Poids

48,6 kg

Logística | Logistics | Logistique

	20'	40'	40 H.C.	70 m ³	100 m ³
1X	13	29	34	-	34

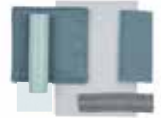

Ver combinaciones de colores en página 447.
See color combinations on page 447.

Anthea Easy Chair

Designed by Monica Armani



Asiento individual con estructura de aluminio lacado, cojines y tapizados idóneos para el exterior y respaldo en cinta de pasamanería trenzada sobre tubo de aluminio. Amplia gama cromática y combinaciones para escoger entre cojines opcionales. Apto para exterior.

Individual seat with lacquered aluminium frame, cushions and upholstery suitable for outdoor use and backrest in braided passageway tape on aluminium tube. Wide range of colours and combinations to choose from the optional cushions. Suitable for outdoor use.

Assise individuelle avec structure en aluminium laqué, coussins et tapissés parfaits pour l'extérieur et dossier en ruban de passementerie tressée sur des tubes en aluminium. Vaste gamme de couleur et combinaisons à choisir parmi les couleurs en option. Utilisable à l'extérieur.

Medidas | Measures | Measures

W 95cm x L 87cm x H 60cm x Hs 37,5cm x Ha 60cm
W 37,4in x L 34,25in x H 23,62in x Hs 14,76in x Ha 23,62in

Peso | Weight | Poids

23,3 kg

Logística | Logistics | Logistique

	20'	40'	40 H.C.	70 m ³	100 m ³
1X	36	78	92	-	92



Ver combinaciones de colores en página 447.
See color combinations on page 447.

Anthea Coffe Table

Designed by Monica Armani



Mesa auxiliar de estructura en aluminio de fundición y extrusión. Tablero de HPL con una amplia gama cromática y de combinaciones. Apto para exterior.

Side table made of casted an extruded aluminum structure with an HPL tabletop available in a wide range of colors and combinations. Suitable for exterior use.

Table d'appoint constituée d'une structure en aluminium extrudé moulé avec un plateau en HPL disponible dans une large gamme de couleurs et de combinaisons. Convient pour un usage extérieur.

Medidas | Measures | Measures

W 80,5cm x L 80,5cm x H 25cm
W 31,69in x L 31,69in x H 9,84in x

Peso | Weight | Poids

22,3 kg

Logística | Logistics | Logistique

	20'	40'	40 H.C.	70 m ³	100 m ³
1X	67	147	174	-	174



Ver combinaciones de colores en página 447.
See color combinations on page 447.

Anthea Side Table

Designed by Monica Armani

Mesa auxiliar baja. Estructura en tubo de aluminio y tablero en HPL. Amplia gama cromática y combinaciones. Apto para exterior.

Low side table. Structure in aluminum tube, HPL tabletop available in a wide range of colours and combinations. Suitable for outdoor use.

Table d'appoint basse. Structure en tube d'aluminium, plateau en HPL disponible dans une large gamme de couleurs et de combinaisons. Convient pour une utilisation en extérieur.



Medidas | Measures | Mesures

W 50cm x L 50cm x H 35cm
W 19,69in x L 19,69in x H 13,78in

Peso | Weight | Poids

6,2 kg

Logística | Logistics | Logistique

	20'	40'	40' HC	70 m ³	100 m ³
1X	33	72	85	-	85



Ver combinaciones de colores en página 447.
See color combinations on page 447.

Anthea Ottoman

Designed by Monica Armani

Estructura de aluminio lacada. Cojines y tapizados idóneos para el exterior. Amplia gama cromática y combinaciones. Apto para exterior.

Lacquered aluminum structure. Cushions and upholstery suitable for outdoors. Wide chromatic range and combinations. Suitable for outdoors.

Structure en aluminium laqué. Coussins et rembourrage adapté pour l'extérieur. Large gamme et combinaisons chromatiques. Convient pour l'extérieur.



Medidas | Measures | Mesures

W 75cm x L 79cm x H 37,5cm
W 29,53in x L 31,10in x H 14,76in

Peso | Weight | Poids

17,3 kg

Logística | Logistics | Logistique

	20'	40'	40' HC	70 m ³	100 m ³
1X	61	134	158	-	158



Ver combinaciones de colores en página 447.
See color combinations on page 447.

Anou

Designed by Jorge Pensi



Sillón para uso interior y exterior. Carcasa inyectada en polipropileno con fibra de vidrio. Estructura de acero pintado. Cojín con cremallera desenfundables. Tejido Sunbrella.

Armchair for indoor and outdoor use. Polypropylene injected frame with fibreglass. Painted steel structure. Removable zippered cushion. Sunbrella fabric.

Fauteuil pour usage intérieur et extérieur. Siège injecté en polypropylène et fibre de verre. Structure en acier peint. Coussin avec zip déhoussable. Tissu Sunbrella.



Medidas | Measures | Mesures

W 83,1cm x L 89,6cm x H 87,3cm x Hs 47,7cm x Ha 55,6cm
W 32,72in x L 35,28in x H 34,37in x Hs 18,78in x Ha 21,89in

Peso | Weight | Poids

18,15 kg

Logística | Logistics | Logistique

	20'	40'	40' HC	70 m ³	100 m ³
1X	24	52	52	96	100



Mint/Gris Verdoso
Mint/Green Grey

Arbor Pebble/ Marfil
Arbor Pebble/Ivory

Adriatic/Turquesa
Adriatic/Turquoise

Calabaza/ Marfil
Pumpkin/Ivory



Anou Wood

Designed by Jorge Pensi



Sillón para uso interior y exterior. Carcasa inyectada en polipropileno con fibra de vidrio. Estructura de hierro pintado y patas de madera tropical. Cojín con cremallera desenfundables. Tejido Sunbrella.

Armchair for indoor and outdoor use. Polypropylene injected frame with fibreglass. Painted iron structure and wooden legs. Removable zipped cushion. Sunbrella fabric.

Fauteuil pour usage intérieur et extérieur. Siège injecté en polypropylène et fibre de verre. Structure en fer peint et pieds en bois. Coussin avec zip déhoussable. Tissu Sunbrella.

Medidas | Measures | Measures

W 83,1cm x L 96,2cm x H 86,3cm x Hs 47,3cm x Ha 55,2cm
W 32,72in x L 37,87in x H 33,98in x Hs 18,62in x Ha 21,73in

Peso | Weight | Poids

17,19 kg

Logística | Logistics | Logistique



1X	24	52	52	96	100

Anou Toledo

Designed by Jorge Pensi



Sillón para uso interior y exterior. Carcasa inyectada en polipropileno con fibra de vidrio. Estructura de aluminio pintado. Cojín con cremallera desenfundables. Tejido Sunbrella.

Armchair for indoor and outdoor use. Polypropylene injected frame with fibreglass. Painted aluminium structure. Removable zipped cushion. Sunbrella fabric.

Fauteuil pour usage intérieur et extérieur. Siège injecté en polypropylène et fibre de verre. Structure en aluminium peint. Coussin avec zip déhoussable. Tissu Sunbrella.

Medidas | Measures | Measures

W 83,1cm x L 87,4cm x H 89,7cm x Hs 46,3cm x Ha 54,2cm
W 32,72in x L 34,41in x H 35,31in x Hs 18,23in x Ha 21,34in

Peso | Weight | Poids

16,25 kg

Logística | Logistics | Logistique



1X	24	52	52	96	100

Anou Rocking

Designed by Jorge Pensi



Sillón para uso interior y exterior. Carcasa inyectada en polipropileno con fibra de vidrio. Estructura de acero pintado. Cojín con cremallera desenfundables. Tejido Sunbrella.

Armchair for indoor and outdoor use. Polypropylene injected frame with fibreglass. Painted steel structure. Removable zipped cushion. Sunbrella fabric.

Fauteuil pour usage intérieur et extérieur. Siège injecté en polypropylène et fibre de verre. Structure en acier peint. Coussin avec zip déhoussable. Tissu Sunbrella.

Medidas | Measures | Measures

W 83,1cm x L 89,6cm x H 87,7cm x Hs 49,7cm x Ha 57,6cm
W 32,72in x L 35,28in x H 34,53in x Hs 19,57in x Ha 22,68in

Peso | Weight | Poids

14,72 kg

Logística | Logistics | Logistique



1X	24	52	52	96	100

Anou Toledo

side table

Designed by Jorge Pensi



Mesa auxiliar con pie de aluminio pintado y tablero de hpl.

Side table with a painted aluminum base and an hpl table top.

Table auxiliaire avec pied en aluminium peint et plateau en hpl.

Medidas | Measures | Mesures

W 67cm x L 54,7cm x H 35,4cm
W 26,38in x L 21,54in x H 13,94in

Peso | Weight | Poids

8,9 kg

Logística | Logistics | Logistique



Certificaciones | Certifications

UNEEN581.3, BIFMAX5.5

	20'	40'	40' HC	70 m ³	100 m ³
1X	225	482	520	550	600

Anou 4 Patas

side table

Designed by Jorge Pensi



Mesa auxiliar con estructura de acero pintado y tablero de hpl.

Side table with a painted steel base and an hpl table top.

Table auxiliaire avec pied en acier peint et plateau en hpl.

Medidas | Measures | Mesures

W 67cm x L 54,7cm x H 35,4cm
W 26,38in x L 21,54in x H 13,94in

Peso | Weight | Poids

7,26 kg

Logística | Logistics | Logistique



Certificaciones | Certifications

UNEEN581.3, BIFMAX5.6

	20'	40'	40' HC	70 m ³	100 m ³
1X	225	482	520	550	600

Anou 4 Patas

pouf

Designed by Jorge Pensi



Pouf con estructura de acero pintado, tablero de HPL y cojín tapizado en tejido Sunbrella.

Pouf with a painted steel base, HPL table top and upholstered cushion with Sunbrella fabric.

Pouf avec pied en acier peint, plateau en HPL et coussin tapisé avec tissu Sunbrella.

Medidas | Measures | Mesures

W 71cm x L 58,7cm x H 48,4cm
W 27,95in x L 23,11in x H 19,06in

Peso | Weight | Poids

8,9 kg

Logística | Logistics | Logistique



Certificaciones | Certifications

UNEEN581.3, BIFMAX5.7

	20'	40'	40' HC	70 m ³	100 m ³
1X	146	294	330	350	400

Anou Toledo

pouf

Designed by Jorge Pensi



Pouf con pie de aluminio pintado, tablero de HPL y cojín tapizado en tejido Sunbrella.

Pouf with a painted aluminum base, HPL table top and a upholstered cushion with Sunbrella fabric.

Pouf avec pied en aluminium peint, plateau en HPL et coussin tapisé avec tissu Sunbrella.

Medidas | Measures | Measures

W 71cm x L 58,7cm x H 48,4cm
W 27,95in x L 23,11in x H 19,06in

Peso | Weight | Poids

10,52 kg

Logística | Logistics | Logistique



Adriatic/Turquesa
Adriatic/Turquoise



Calabaza/Marfil
Pumpkin/Ivory



Mint/Cris Verdoso
Mint/Green Grey



Arbor Pebble/Marfil
Arbor Pebble/Ivory



Certificaciones | Certifications

UNEEN581.3, BIFMAX5.8

1X	146	294	330	350	400

Sillón Dunas

Designed by Jordi Ribaudí



Sillón con perfil exclusivo de aluminio anodizado. Uniones de los travesaños de fundición de aluminio. Brazos opcionales. Tacos antideslizantes. Textilene Batyline ignífugo. Tornillería de acero inoxidable.

One-seat sofa with an exclusive anodized aluminium profile. Joints in the crossbars made of cast aluminium. Optional armrests. Anti-slip feet. Flame-retardant Textilene Batyline. Screws made of stainless steel.

Fauteuil au profil exclusif en aluminium anodisé. Unions des traverses en fonte d'aluminium. Bras en option. Embouts antidérapants. Textilène Batyline ignifuge. Visserie en acier inoxydable.

Medidas | Measures | Measures

W 70cm x L 90cm x H 76,2cm x Hs 42cm
W 27,56in x L 35,43in x H 30,00in x Hs 16,54in

Peso | Weight | Poids

14 kg

Logística | Logistics | Logistique



Titanio
Titanium



Blanco
White

1X	79	158	174	190	-

Sofa Dunas

Designed by Jordi Ribaudí



Sofá con perfil exclusivo de aluminio anodizado. Uniones de los travesaños de fundición de aluminio. Brazos opcionales. Tacos antideslizantes. Textilene Batyline ignífugo. Tornillería de acero inoxidable.

Two-seat sofa with an exclusive anodized aluminium profile. Joints in the crossbars made of cast aluminium. Optional armrests. Anti-slip feet. Flame-retardant Textilene Batyline. Screws made of stainless steel.

Sofa au profil exclusif en aluminium anodisé. Unions des traverses en fonte d'aluminium. Bras en option. Embouts antidérapants. Textilène Batyline ignifuge. Visserie en acier inoxydable.

Medidas | Measures | Measures

W 90cm x L 140cm x H 76,2cm x Hs 42cm
W 35,43in x L 55,12in x H 30,00in x Hs 16,54in

Peso | Weight | Poids

18,4 kg

Logística | Logistics | Logistique



Titanio
Titanium



Blanco
White

1X	43	87	95	104	-

* Sujeto a condiciones. Por favor, consultar.
* Subject to conditions. Please inquire.
* Sous réserve de conditions. Merci de consulter.

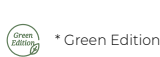

* Green Edition

Mesa Dunas

footrest

Designed by Jordi Ribaudí



Mesa baja de perfil exclusivo de aluminio anodizado. Uniones de los travesaños de fundición de aluminio. Tacos antideslizantes. Textilene Batyline Plus ignífugo. Tornillería de acero inoxidable.

Low table with an exclusive anodized aluminium profile. Joints in the crossbars made of cast aluminium. Anti-slip feet. Flame-retardant Textilene Batyline. Screws made of stainless steel.

Table basse au profil exclusif en aluminium anodisé. Unions des traverses en fonte d'aluminium. Embouts antidérapants. Textilène Batyline ignifuge. Visserie en acier inoxydable.

Medidas | Measures | Mesures

W 100cm x L 75cm x H 41,7cm
W 39,37in x L 29,53in x H 16,42in

Peso | Weight | Poids

8,5 kg

Logística | Logistics | Logistique

	20'	40'	40' HC	70 m ³	100 m ³
1X	132	265	291	317	-



Sofa Milano

Designed by Joan Gaspar



Sofá apilable para uso interior y exterior. Estructura de aluminio anodizado pintado por pulverización y secado al horno de 30x30mm y 2mm de grosor. Cojín de poliéster de color beige.

Stackable sofa for indoor and outdoor use. Anodized aluminum structure painted by spray drying in the oven 30x30mm and 2mm thick. Beige polyester cushion.

Canapé empilable pour usage intérieur et extérieur. Structure en aluminium anodisé peint par pulvérisation et séché au four de 30x30 mm et de 2mm d'épaisseur. Coussin en polyester de couleur beige.

Medidas | Measures | Mesures

W 139cm x L 59cm x H 76cm x Hs 36cm x Ha 57cm
W 54,72in x L 23,23in x H 29,92in x Hs 14,17in x Ha 22,44in

Peso | Weight | Poids

16 kg

Logística | Logistics | Logistique

	20'	40'	40' HC	70 m ³	100 m ³
1X	38	80	-	113	-



Cojines incluidos
Cushions included
Coussins inclus

Sillón Milano

Designed by Joan Gaspar



Sillón bajo para uso interior y exterior. Estructura de aluminio anodizado pintado por pulverización y secado al horno de 30x30mm y 2mm de grosor. Cojín de poliéster de color beige.

Low chair for indoor and outdoor use. Anodized aluminum structure painted by spray drying in the oven 30x30mm and 2mm thick. Beige polyester cushion.

Fauteuil bas pour usage intérieur et extérieur. Structure en aluminium anodisé peint par pulvérisation et séché au four de 30x30 mm et de 2mm d'épaisseur. Coussin en polyester de couleur beige.

Medidas | Measures | Mesures

W 68,5cm x L 59cm x H 76cm x Hs 36cm x Ha 57cm
W 26,97in x L 23,23in x H 29,92in x Hs 14,17in x Ha 22,44in

Peso | Weight | Poids

8,2 kg

Logística | Logistics | Logistique

	20'	40'	40' HC	70 m ³	100 m ³
1X	69	141	-	170	-



Cojines incluidos
Cushions included
Coussins inclus

Mesa Milano

coffe

Designed by Joan Gaspar



Mesa de centro apilable para uso interior y exterior. Estructura de aluminio anodizado pintado por pulverización y secado al horno.

stackable centre table for indoor and outdoor use. Anodised aluminium structure, spray finish and kiln-dried.

Table centrale empilable pour usage intérieur et extérieur. Structure en aluminium anodisé peint par pulvérisation et séché au four.

Medidas | Measures | Mesures

W 60cm x L 101cm x H 35,8cm
W 23,62in x L 39,76in x H 14,09in

Peso | Weight | Poids

8 kg

Logística | Logistics | Logistique

	20'	40'	40 HC	70 m ³	100 m ³
1X	120	250	250	-	300



Mesa Milano

ice cube

Designed by Joan Gaspar



Mesa auxiliar de 50x45 cm para uso interior y exterior. Estructura de aluminio anodizado pintado por pulverización al horno, de 40x40 mm y 2 mm de grosor. Sobre 3 mm de grosor. Contiene cubitera de policarbonato transparente negro.

Side table 50x45 for indoor and outdoor use. Anodised aluminium structure, painted by oven spraying, 40x40 mm and 2 mm thick. About 3 mm thick. Contains black transparent polycarbonate cover.

Table d'appoint de 50x45 pour usage intérieur et extérieur. Structure en aluminium anodisé peint par pulvérisation au four de 40x40 mm et de 2 mm d'épaisseur. Sur 3 mm d'épaisseur. Contient un seau à glace en polycarbonate transparent noir.

Medidas | Measures | Mesures

W 45cm x L 50cm x H 35,8cm
W 17,72in x L 19,69in x H 14,09in

Peso | Weight | Poids

5,06 kg

Logística | Logistics | Logistique

	20'	40'	40 HC	70 m ³	100 m ³
1X	-	480	-	540	-



Silla Espiga

lounge

Designed by Jordi Ribaudi



Sillón bajo con estructura patín en acero pintado. Cinta de polyester ignífuga e hidrófuga. Tacos antideslizantes. Tornillería de acero inoxidable.

Lounge chair with painted steel sled base. Waterproof and fire-retardant Polyester bands. Non-slid glides and stainless steel hardware.

Fauteuil bas avec patin structure en acier peint. Bande de polyester ignifuge et hydrofuge. Embouts antidérapants. Visserie en acier inoxydable.

Medidas | Measures | Mesures

W 68,8cm x L 66,7cm x H 75,4cm x Hs 43,1cm
W 27,09in x L 26,26in x H 29,69in x Hs 16,97in

Peso | Weight | Poids

7,52 kg

Logística | Logistics | Logistique

	20'	40'	40 HC	70 m ³	100 m ³
2X	240	481	529	-	577



Espiga

Designed by Jordi Ribaudí

Mesa baja con estructura patín. Estructura de acero pintado. Sobre de HPL con efecto relieve en impresión digital. Tacos antideslizantes. Tornillería de acero inoxidable.

Low side table with sled base structure of painted. HPL tabletop with a relief effect in digital printing. Non-slip glides. Stainless steel hardware.

Table basse avec structure patin. Structure en acier peint. Dessus en phénolique, effet relief par impression digitale. Embouts antidérapants. Visserie en acier inoxydable.



Medidas | Measures | Mesures

W 66,2cm x L 64,6cm x H 29,3cm
W 26,06in x L 25,43in x H 11,54in

Peso | Weight | Poids

9,6 kg

Logística | Logistics | Logistique

	20'	40'	40' HC	70 m ³	100 m ³
2X	431	862	948	1034	0



Bini

Designed by Joan Gaspar

NEW



Silla para uso interior y exterior. Fabricada en polipropileno con fibra de vidrio. Protección UV.

Chair for indoor and outdoor use. Polypropylene injected frame with fibreglass. UV protection.

Chaise pour usage intérieur et extérieur. Fabriquée en polypropylène et fibre de verre. Protection UV.

Medidas | Measures | Mesures

W 60cm x L 60cm x H 86,6cm
W 23,62in x L 23,62in x H 34,09in

Peso | Weight | Poids

4,825 kg

Apilado | Stackable | Empilable

9 unidades | units | unités

Logística | Logistics | Logistique

	20'	40'	40' HC	70 m ³	100 m ³
2X	134	316	362	480	800
4X	256	524	572	800	800
P24	576	1152	1152	1296	1344



Certificaciones | Certifications

UNEEN581-1, UNEEN581-2

Bini Lounge

Designed by Joan Gaspar

NEW



Sillón fabricado en polipropileno con fibra de vidrio. Protección UV.

Armchair made from polypropylene with fibreglass. UV protection.

Fauteuil en polypropylène avec fibre de verre. Protection UV.

Medidas | Measures | Mesures

W 60cm x L 71cm x H 72,65cm x Hs 36cm
W 23,62in x L 27,95in x H 28,6in x Hs 14,17in

Peso | Weight | Poids

4,9 kg

Apilado | Stackable | Empilable

11 unidades | units | unités

Logística | Logistics | Logistique

	20'	40'	40' HC	70 m ³	100 m ³
2X	100	220	330	408	828
4X	200	440	660	816	828
P22	396	880	880	1012	1012



Certificaciones | Certifications

UNEEN581-1, UNEEN581-2

Mesa Bini

Designed by Joan Gaspar

NEW



Mesa Bini para uso interior y exterior. Fabricada en polipropileno con fibra de vidrio, con protección UV.

Bini table for indoor and outdoor use. It is made of polypropylene with fiberglass, with UV protection.

Table Bini pour usage intérieur et extérieur. Fabriqué en polypropylène avec fibre de verre, avec protection UV.

Medidas | Measures | Mesures

Ø70cm x H 75,5cm
Ø27,56in x H 29,72in

Peso | Weight | Poids Apilado | Stackable | Empilable

7,34 kg unidades | units | unités

Logística | Logistics | Logistique



Toscano
Tuscan



Terracota
Terracotta



Marfil
Ivory



Arena
Sand



Gris Oscuro
Dark Grey



Gris Verdoso
Green Grey

Certificaciones | Certifications

UNEEN581-1, UNEEN581-2

	20'	40'	40 HC	70 m ³	100 m ³
1X	450	912	1056	1254	1360

Mesa Bini

lounge

Designed by Joan Gaspar

NEW



Mesa Bini Lounge para uso interior y exterior. Fabricado en polipropileno con fibra de vidrio, con protección UV.

Bini Lounge table for indoor and outdoor use. Made of polypropylene with fiberglass, with UV protection.

Table Bini Lounge pour usage intérieur et extérieur. Fabriqué en polypropylène avec fibre de verre, avec protection UV.

Medidas | Measures | Mesures

Ø70cm x H 40cm
Ø27,56in x H 15,75in

Peso | Weight | Poids

5,5 kg

Logística | Logistics | Logistique



Toscano
Tuscan



Terracota
Terracotta



Marfil
Ivory



Arena
Sand



Gris Oscuro
Dark Grey



Gris Verdoso
Green Grey

Certificaciones | Certifications

UNEEN581-1, UNEEN581-2

	20'	40'	40 HC	70 m ³	100 m ³
1X	450	912	1056	1254	1360

Set Raff

Designed by Joan Gaspar



Set para uso interior y exterior, compuesto por 2 sillones y una mesa. Inyectado con fibra de vidrio y PP. Protección UV. Peso neto 16kg. El set está disponible en dos versiones, con o sin cojines. Óptimo packaging.

Set for indoor and outdoor use, consisting of 2 armchairs and a table. Injected with fiberglass and PP. UV protection. Net weight 16kg. The set is available in two versions, with or without cushions. Optimal packaging.

Set pour usage intérieur et extérieur, composé par 2 fauteuils et d'une table. Injecté avec fibre de verre et PP. Protection UV. Poids net 16kg. Le set est disponible en deux versions, avec ou sans coussins. Emballage optimal.



Burdeos
Burgundy



Toscano
Tuscan



Chocolate
Chocolate



Arena
Sand



Negro
Black



Blanco
White

Peso | Weight | Poids

16 kg

Logística | Logistics | Logistique

Cada una de las piezas del set se pueden adquirir también por separado. Chacune des pièces du set peuvent également être achetée séparément. Each piece of the set can be also purchased separately.

	20'	40'	40 HC	70 m ³	100 m ³
1X	81	180	240	384	416

Opcional Cojines
Optional Cushions
Optionnel Coussins

Color cojines: Taupe
Cushions colour: Taupe
Coloris coussins: Taupe



Sillón Raff

Designed by Joan Gaspar



Sillón para uso interior y exterior. Inyectado con fibra de vidrio y PP. Protección UV.

Armchair for indoor and outdoor use. Injected with fiberglass and PP. UV protection.

Fauteuil pour un usage intérieur et extérieur. injecté avec PP et fibre de verre. Protection UV.

Medidas | Measures | Mesures

W 58,7cm x L 53,5cm x H 76,5cm x Hs 45cm

W 23,11in x L 21,06in x H 30,12in x Hs 17,72in

Peso | Weight | Poids

6,62 kg

Logística | Logistics | Logistique

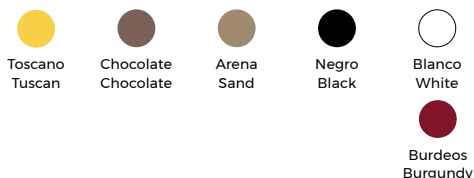

Certificaciones | Certifications

UNEEN581-1, UNEEN581-2, UNEN16139

	20'	40'	40' HC	70 m ³	100 m ³
4X	176	400	400	528	576

Mesa Raff

Designed by Joan Gaspar



Mesa para uso interior y exterior. Inyectado con fibra de vidrio y PP. Protección UV.

Table for indoor and outdoor use. Injected with fiberglass and PP. UV protection.

Table pour un usage intérieur et extérieur. injecté avec PP et fibre de verre. Protection UV.

Medidas | Measures | Mesures

W 40cm x L 40cm x H 37cm

W 15,75in x L 15,75in x H 14,57in

Peso | Weight | Poids

1,5 kg

Apilado | Stackable | Empilable

unidades | units | unités

Logística | Logistics | Logistique



Certificaciones | Certifications

UNEEN581-1, UNEEN581-3

	20'	40'	40' HC	70 m ³	100 m ³
4X	1352	2800	3308	3400	4760

Set Click-Clack

Designed by Josep Lluscà



Set de polipropileno inyectado para uso interior y exterior compuesto por 1 sofá doble, 2 sillones, 1 mesa y 3 cojines color beige. Óptimo packaging.

Set of injected polypropylene for indoor and outdoor use consisting of 1 double sofa, 2 armchairs, 1 table and 3 beige cushions. Optimal packaging.

Set injectée en polypropylène pour usage intérieur et extérieur composée par 1 canapé double, 2 fauteuils, 1 table et 3 coussins beiges. Emballage optimal.



Peso | Weight | Poids

45 kg

Logística | Logistics | Logistique



Cada una de las piezas del set se pueden adquirir también por separado. Chacune des pièces du set peuvent également être achetée séparément. Each piece of the set can be also purchased separately.

Cojines incluidos
Cushions included
Coussins inclus



	20'	40'	40' HC	70 m ³	100 m ³
1X	51	110	135	155	200

Sillón Click-Clack

Designed by Josep Llusçà



Sillón para uso interior y exterior. Inyectado en fibra de vidrio con PP mediante tecnología de moldeo asistida por gas. Protección contra rayos UV. Se entrega desmontado en un óptimo packaging. Cojines opcionales. Se venden por separado.

Armchair for indoor and outdoor use. Injected in fiberglass with PP using gas assisted injection moulding technology. UV Protection. Delivered unassembled in an optimal packaging. Optional cushions. Sold separately.

Fauteuil d'intérieur et extérieur. Injecté en fibre de verre avec PP, en utilisant technologie de moulage assistée par gaz. Protection UV. Livré démonté dans un packaging optimal. Coussins optionnels. Vendu séparément.

Medidas | Measures | Measures

W 74cm x L 64,5cm x H 72,5cm x Hs 42cm
W 29,13in x L 25,39in x H 28,54in x Hs 16,54in

Peso | Weight | Poids

10,5 kg

Logística | Logistics | Logistique



Certificaciones | Certifications

UNEEN581-1

	20'	40'	40 HC	70 m ³	100 m ³
1X	99	225	225	297	360

Sofá Click-Clack

Designed by Josep Llusçà



Sofá para uso interior y exterior. Inyectado en fibra de vidrio con PP mediante tecnología de moldeo asistida por gas. Protección contra rayos UV. Se entrega desmontado en un óptimo packaging. Cojines opcionales. Se venden por separado.

Sofa for indoor and outdoor use. Injected in fiberglass with PP using gas assisted injection moulding technology. UV Protection. Delivered unassembled in an optimal packaging. Optional cushions. Sold separately.

Canapé d'intérieur et extérieur. Injecté en fibre de verre avec PP, en utilisant technologie de moulage assistée par gaz. Protection UV. Livré démonté dans un packaging optimal. Coussins optionnels. Vendu séparément.

Medidas | Measures | Measures

W 124cm x L 64,5cm x H 72,5cm x Hs 42cm
W 48,82in x L 25,39in x H 28,54in x Hs 16,54in

Peso | Weight | Poids

15 kg

Logística | Logistics | Logistique



Certificaciones | Certifications

UNEEN581-1

	20'	40'	40 HC	70 m ³	100 m ³
1X	66	150	150	198	240

Mesa Click-Clack

Designed by Josep Llusçà



Mesa de centro de 90x45 cm para uso interior y exterior. Inyectada en fibra de vidrio con PP. Protección contra rayos UV.

Coffe table 90x45 cm for indoor and outdoor use. Injected in fiberglass with PP. UV Protection.

Table basse 90x45 cm d'intérieur et extérieur. Injectée en fibre de verre avec PP. Protection UV.

Medidas | Measures | Measures

W 45cm x L 90cm x H 45cm
W 17,72in x L 35,43in x H 17,72in

Peso | Weight | Poids

4,8 kg

Logística | Logistics | Logistique



Certificaciones | Certifications

UNEEN581-1, UNEN16139

	20'	40'	40 HC	70 m ³	100 m ³
1X	696	1412	1550	1770	2200

Tumbonas

Sun Lounger / Bain de soleil



Anthea Poolbed

Designed by Monica Armani



Tumbona con estructura de acero inoxidable lacado. Inclinación graduable, complementa el espacio exterior con el resto de mobiliario y accesorios de la serie. Amplía gama cromática y combinaciones.

Hammock compatible with the rest of the finishes in the series. Adjustable tilt, complements the outer area with the rest of the furniture and accessories in the series.

Bain de Soleil compatible avec le reste des finitions de la série. Inclinaison réglable, il complète l'espace extérieur avec le reste du mobilier et accessoires de la série.

Medidas | Measures | Mesures

W 65,5cm x L 213cm x H 39,4cm
W 25,79in x L 83,86in x H 15,51in

Peso | Weight | Poids

41 kg

Logística | Logistics | Logistique

	20'	40'	40' HC	70 m ³	100 m ³
1X	33	72	85	-	85



Ver combinaciones de colores en página 447.
See color combinations on page 447.

Dunas

Designed by Jordi Ribaudí



Tumbona con perfil exclusivo de aluminio anodizado. Uniones de los travesaños de fundición de aluminio. Tacos antideslizantes. Textilene Batyline ignífugo. Tornillería de acero inoxidable.

Lounger with exclusive anodised aluminium profile. Cast aluminium crossbar joints. Anti-slip pads. Fireproof Batyline Textiline. Stainless steel fasteners.

Bain de Soleil avec profil exclusif en aluminium anodisé. Raccords des traverses en fonte d'aluminium. Patins antidérapants. Textilène Batyline ignifuge. Visserie en acier inoxydable.

Medidas | Measures | Mesures

W 65cm x L 202cm x H 55cm x Hs 40cm
W 25,59in x L 79,53in x H 21,65in x Hs 15,75in

Peso | Weight | Poids

17,5 kg

Logística | Logistics | Logistique

	20'	40'	40' HC	70 m ³	100 m ³
1X	57	114	125	-	506



Milano

Designed by Joan Gaspar



Tumbona apilable para uso interior y exterior. Estructura de aluminio anodizado pintado por pulverización al horno de 40x40 mm y de 2 mm de grosor. Textilene de 1.170 gr/m², termosoldado para mayor resistencia, y trama y urdimbre de doble hilo. Renclinable en 5 posiciones, incluyendo posición extraplana ideal para estar tumbado boca abajo.

Stackable lounger for indoor and outdoor use. Anodized aluminum structure painted by kiln spray 40x40 mm and 2 mm thick. 1,170 gr / m² Textilene, heat welded for greater resistance, and double yarn weft and warp. Reclinable in 5 positions, including extra flat position ideal for lying on your stomach.

Bain de Soleil empilable pour usage intérieur et extérieur. Structure en aluminium anodisé peint par pulvérisation au four de 40x40 mm et de 2 mm d'épaisseur. Textilene de 1 170 gr/m², thermosoudé, pour une meilleure résistance, et trame et chaîne à double fil. Inclinaison sur 5 positions, dont une position extraplatte idéale pour s'allonger.

Medidas | Measures | Mesures

W 74,5cm x L 200cm x H 35,8cm
W 29,33in x L 78,74in x H 14,09in

Peso | Weight | Poids

19,25 kg

Logística | Logistics | Logistique

	20'	40'	40' HC	70 m ³	100 m ³
2X	56	128	160	-	200



Textilene | Textilene | Textilène

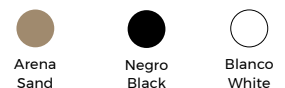

Lucca 17

Designed by Joan Casas



Tumbona con brazos. Perfiles exclusivos de aluminio anodizado. Uniones de aluminio. Travesaño de fundición de aluminio. Tornillería de acero inoxidable. Tacos antideslizantes. Textilene Batyline ignífugo.

Sunlounger with armrests. Exclusive anodized aluminium profiles. Joints made of aluminium. Crossbar made of cast aluminium. Screws made of stainless steel. Anti-slip feet. Flame-retardant Textilene Batyline.

Bain de soleil avec bras. Profils exclusifs en aluminium anodisé. Unions en aluminium. Traverse en fonte d'aluminium. Visserie en acier inoxydable. Embouts antidérapants. Textilène Batyline ignifuge.

Medidas | Measures | Mesures

W 62,2cm x L 170,5cm x H 36,5cm x Hs 30cm x Ha 47,5cm
W 24,49in x L 67,13in x H 14,37in x Hs 11,81in x Ha 18,70in

Peso | Weight | Poids

9,5 kg

Logística | Logistics | Logistique

	20'	40'	40' HC	70 m ³	100 m ³
2X	39	79	86	94	-

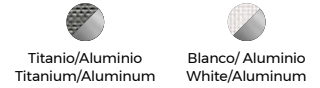

Lucca 15

Designed by Joan Casas



Tumbona corta con brazos. Perfiles exclusivos de aluminio anodizado. Uniones y travesaño en fundición de aluminio. Tornillería de acero inoxidable. Tacos antideslizantes. Textilene Batyline ignífugo.

Short sunlounger with armrests. Exclusive anodized aluminium profiles. Joints and crossbar made of cast aluminium. Screws made of stainless steel. Anti-slip feet. Flame-retardant Textilene Batyline.

Bain de soleil courte avec bras. Profils exclusifs en aluminium anodisé. Unions et traverse en fonte d'aluminium. Visserie en acier inoxydable. Embouts antidérapants. Textilène Batyline ignifuge.

Medidas | Measures | Mesures

W 62,2cm x L 97,8cm x H 36,5cm x Hs 30cm x Ha 47,5cm
W 24,49in x L 38,50in x H 14,37in x Hs 11,81in x Ha 18,70in

Peso | Weight | Poids Apilado | Stackable | Empilable

7,28 kg 2 unidades | units | unités

Logística | Logistics | Logistique

	20'	40'	40' HC	70 m ³	100 m ³
2X	118	236	260	283	-

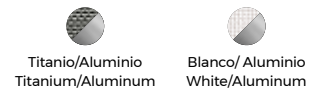

Certificaciones | Certifications

Lucca S-32

Designed by Joan Casas



Tumbona con inserción en brazos de madera tropical. Perfiles exclusivos de aluminio anodizado. Uniones de aluminio. Terminales de fundición de aluminio. Tornillería de acero inoxidable. Ruedas traseras de aluminio. Tacos antideslizantes. Textilene Batyline ignífugo.

Sunlounger with a tropical wood insert in the armrests. Exclusive anodized aluminium profiles. Joints made of aluminium. Ends made of cast aluminium. Screws made of stainless steel. Back wheels made of aluminium. Anti-slip feet. Flame-retardant Textilene Batyline.

Bain de soleil avec insertion dans les bras de bois tropical. Profils exclusifs en aluminium anodisé. Unions en aluminium. Terminaux en fonte d'aluminium. Visserie en acier inoxydable. Roues arrière en aluminium. Embouts antidérapants. Textilène Batyline ignifuge.

Medidas | Measures | Mesures

W 70,9cm x L 212,5cm x H 48cm
W 27,91in x L 83,66in x H 18,90in

Peso | Weight | Poids

13,4 kg

Logística | Logistics | Logistique

	20'	40'	40' HC	70 m ³	100 m ³
1X	39	79	86	-	94

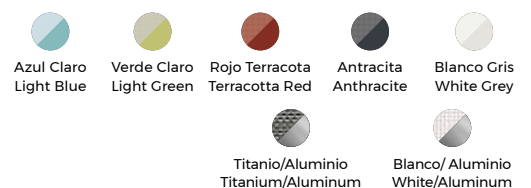

* Sujeto a condiciones. Por favor, consultar.
* Subject to conditions. Please inquire.
* Sous réserve de conditions. Merci de consulter.

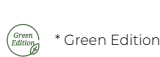

Lucca S-36

Designed by Joan Casas

Tumbona corta con inserción en brazos de madera tropical. Perfiles exclusivos de aluminio anodizado. Uniones de aluminio. Terminales de fundición de aluminio. Tornillería de acero inoxidable. Tacos antideslizantes en color negro. Textilene Batyline ignífugo.

Short sunlounger with a tropical wood insert in the armrests. Exclusive anodized aluminium profiles. Joints made of aluminium. Ends made of cast aluminium. Screws made of stainless steel. Anti-slip feet in black colour. Flame-retardant Textilene Batyline.

Bain de soleil courte avec insertion dans les bras de bois tropical. Profils exclusifs en aluminium anodisé. Unions en aluminium. Terminaux en fontes d'aluminium. Visserie en acier inoxydable. Embouts antidérapants de couleur noir. Textilène Batyline ignifuge.

Medidas | Measures | Mesures

W 70,9cm x L 142cm x H 50cm
W 27,91in x L 55,91in x H 19,69in

Peso | Weight | Poids

9,32 kg

Logística | Logistics | Logistique

	20'	40'	40' HC	70 m ³	100 m ³
 1X	61	121	133	-	146

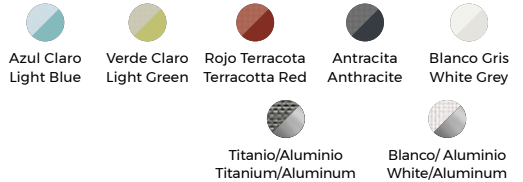

Salvora

Tumbona. Perfiles exclusivos de aluminio anodizado. Uniones de aluminio. Tacos apiladores y antideslizantes. Tornillería de acero inoxidable. Textilene Batyline ignífugo.

Sunlounger with an exclusive framing of anodized aluminium. Unions made of aluminium. Non-slip glides. Stainless steel hardware. Flame retardant textilene Batyline.

Bain de soleil. Profils exclusifs en aluminium anodisé. Unions en aluminium. Embouts empilables et antidérapants. Visserie en acier inoxydable. Textilène Batyline ignifuge.

Medidas | Measures | Mesures

W 221,4cm x L 63,2cm x H 41cm
W 87,17in x L 24,88in x H 16,14in

Peso | Weight | Poids

12,3 kg

Logística | Logistics | Logistique

	20'	40'	40' HC	70 m ³	100 m ³
 3X	57	114	125	137	-

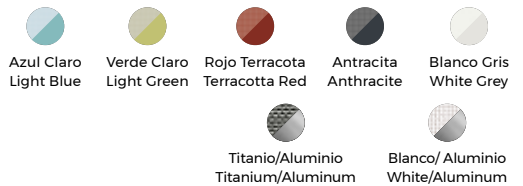

Sky

Designed by Josep Llusçà



Tumbona apilable para uso interior y exterior. Estructura de polipropileno reforzado con fibra de vidrio. Reclinable en 5 posiciones, incluyendo posición extraplana ideal para estar tumbado boca abajo. Respaldo con tope de seguridad. Ruedas de patas traseras y tacos antideslizantes en la delanteras y traseras.

Stackable lounger for indoor and outdoor use. Fiberglass reinforced polypropylene structure. Reclining in 5 positions, including extra flat position ideal for lying on your stomach. Backrest with safety stop. Rear leg wheels and non-slip studs on the front and rear.

Bain de soleil empilable pour usage intérieur et extérieur. Structure en polypropylène renforcé avec fibre de verre. Incluable sur 5 positions, dont une position extraplate idéale pour s'allonger. Dossier avec butée de sécurité. Roulettes sur pieds arrière et cales anti-dérapantes à l'avant et à l'arrière.

Medidas | Measures | Mesures

W 77cm x L 195cm x H 37cm

W 30,31in x L 76,77in x H 14,57in

Peso | Weight | Poids

13,7 kg

Apilado | Stackable | Empilable

20 unidades | units | unités



Certificaciones | Certifications

UNEEN581-1, UNEEN581-2

Logística | Logistics | Logistique

	20'	40'	40 HC	70 m3	100 m3
2X	-	144	-	200	-
p20	180	360	360	440	480



Posicionador de fácil colocación mediante el propio peso. 5 posiciones.

Easy backrest regulation system by own weight. Five-position reclining sunlounger.

Positionneur avec réglage facile par son propre poids. 5 positions du dossier.



Máxima apilabilidad en el mínimo espacio.

Maximum stackability in minimum space.

Empilable au maximum dans un espace minimum.



Ruedas en patas traseras.

Wheels under back legs.

Pieds arrière avec roulettes.



Acabado antideslizante en las patas.

Non-slip end-plates under legs.

Patins antidérapant.



* Sujeto a condiciones. Por favor, consultar.
* Subject to conditions. Please inquire.
* Sous réserve de conditions. Merci de consulter.



Sky Premium

500 gr/m2

BATYLINE
by **Serge Ferrari**

El tejido es un material con cierta elasticidad, transpirable y ha estado diseñado para poder ser fácilmente intercambiable. Tela 500gr/m² (Ferrari) diseñada con formas puras redondas y naturales, termosoldado para mayor resistencia.

Fabric is a material with the right degree of elasticity, that transpires and has been designed to be replaced with very little effort. Textilene 500gr/m² (Ferrari) round shapes designed with pure and natural, heat-welded to improve resistance.

Le tissu est d'un matériel d'une certaine élasticité, transpirable et a été conçu pour pouvoir être facilement interchangeable. Toile 500gr/m² (Ferrari) conçue avec des formes pures rondes et naturelles, thermo-soudée pour une plus grande résistance.

- | | | |
|--|--|--|
| <ul style="list-style-type: none"> · Tejido: 500gr/m² · Termo soldada para evitar roturas y transpirable · Protección UV · Normativa ASTM (Resistente al peso e impacto) · ISO 9001 · ISO 14001 | <ul style="list-style-type: none"> · Fabric: 500gr/m² · Heat-sealing to prevent breakage and breathable · UV protection · ASTM Standards (Weight and impact resistant) · ISO 9001 · ISO 14001 | <ul style="list-style-type: none"> · Tissus: 500gr/m² · Thermo—soudée pour éviter les déchirures et transpirable · UV protection · Norme ASTM (résistant au poids et impact) · ISO 9001 · ISO 14001 |
|--|--|--|



	Structure	Wengué Wenge	Arena Sand	Chocolate Chocolate	Gris Oscuro Dark Grey	Blanco White
Upholstered						
Azul Blue		•				•
Amarillo Yellow		•	•	•	•	•
Chocolate Chocolate		•	•	•		•
Crudo Natural		•	•	•	•	•

Sky Club

850 gr/m2



	Structure	Wengué Wenge	Arena Sand	Chocolate Chocolate	Gris Oscuro Dark Grey	Blanco White
Upholstered						
Blanco White			•	•	•	•
Azul Blue						•
Chocolate Chocolate			•	•		
Gris-Negro Grey-Black					•	•
Beige Beige		•		•	•	

Marina Club

Tumbona apilable con estructura de polipropileno y fibra de vidrio. Textilene de 850 gr/m², termosoldado, para mayor resistencia, y trama y urdimbre de doble hilo. Protección UV. Ruedas en patas traseras y tacos antideslizantes en las delanteras y traseras. Incorpora posavasos. Reclinable en 4 posiciones.

Stackable lounger with polypropylene and fibreglass structure. Textilene 850 gr/m², thermally welded for greater resistance, and double thread weft and warp. UV protection. Wheels on rear legs and anti-slip pads on the front and rear. Built-in drinks holder. Reclinable in 4 positions.

Bain de soleil empilable avec structure en polypropylène et fibre de verre. Textilene de 850 gr/m², thermosoudé, pour une meilleure résistance, et trame et chaîne à double fil. Protection UV. Roulettes sur pieds arrière et cales antidérapantes à l'avant et à l'arrière. Sous-verre inclus. Incluable sur 4 positions.



Medidas | Measures | Measures

W 73cm x L 190cm x H 36,5cm
W 28,74in x L 74,80in x H 14,37in

Peso | Weight | Poids 10,65 kg **Apilado | Stackable | Empilable** 27 unidades | units | unités

Certificaciones | Certifications

UNEENS81-1

	Structure	Wengué Wenge	Gris Plata Grey silver	Marfil Ivory	Gris Oscuro Dark Grey	Blanco White
Upholstered						
Azul Blue						•
Beige Beige			•		•	•
Blue Jeans Blue Jeans			•			•
Azul Atlantico Atlantic Blue			•	•	•	•
Ceniza Ash				•		•
Chocolate Chocolate		•				



Tumbona monobloc
Extremadamente resistente
Protección UV
Ligera

Monoblock sunlounger
Extremely strong
UV protection
Lightweight

Bain de soleil monobloc
Résistance extrême
Protection UV
Légère



Ruedas en patas traseras.
Wheels under back legs.
Pieds arrière avec roulettes.



Posavasos.
Glass holder.
Support de verre.

Logística | Logistics | Logistique

	20'	40'	40 HC	70 m ³	100 m ³
2X	-	144	-	200	-
P25	-	450	-	525	-
P27	-	144	-	200	-

* Sujeto a condiciones. Por favor, consultar.
* Subject to conditions. Please inquire.
* Sous réserve de conditions. Merci de consulter.



* Green Edition

Marina Beach



Tumbona apilable con caja de seguridad incorporada al chasis, en la cual se pueden guardar objetos de manera segura tales como teléfonos móviles, llaves, billeteras, etc. Se cierra con una tapa plástica muy resistente y hermética, y con un candado de acero inoxidable. Ideal para playas y piscinas donde se alquilan las tumbonas, ya que la tapa y el candado permiten ofrecer un servicio adicional al cliente, aumentando así la rentabilidad de cada tumbona alquilada. Tejido abierto de 740gr/m2, que permite que la humedad y la suciedad pasen más fácilmente a través suyo. El tejido se mantiene más tiempo limpio y seco. Fabricado con hilo de poliéster plastificado con protección ultravioleta y termo soldado para una máxima resistencia.

Stackable sun lounger with safety box built into the chassis, in which objects can be stored safely such as mobile phones, keys, wallets, etc. It closes with a very resistant and hermetic plastic cover, and with a stain-less steel padlock. Optimal for beaches and pools where sun loungers are rented, as the cover and padlock allow to offer an additional service to the client, increasing the profitability of each sun lounger. Open fabric, 740gr/m2. Allows moisture and dirt to pass easily through it. The fabric stays clean and dry longer. Made with plasticized polyester yarn with ultraviolet protection and thermo-welded for maximum resistance. FR.

Chaise longue empilable avec coffre intégré au châssis, dans lequel des objets tels que des téléphones portables, des clés, des portefeuilles, etc. peuvent être stockés en toute sécurité. Se ferme avec un couvercle en plastique très résistant et hermétique, et avec un cadenas en acier inoxydable. Idéal pour les plages et les piscines où l'on loue des chaises longues, car le couvercle et cadenas permettent d'offrir un service supplémentaire au client, augmentant ainsi la rentabilité de chaque transat loué. Tissage ajouré de 740gr/m2, qui permet à l'humidité et à la saleté de passer plus facilement. Le tissu reste propre et sec plus longtemps. Fabriqué avec du fil de polyester plastifié avec protection contre les ultraviolets et thermo-soudé pour une résistance maximale.

Certificaciones | Certifications

UNEEN581-1

Medidas | Measures | Mesures

W 73cm x L 190cm x H 36,5cm
W 28,74in x L 74,80in x H 14,37in

Peso | Weight | Poids

10,65 kg

Apilado | Stackable | Empilable

27 unidades | units | unités

Upholstered	Structure	Wengué	Gris Plata	Marfil	Gris Oscuro	Blanco
		Wenge	Grey silver	Ivory	Dark Grey	White
Azul Blue			•			•
Arena Sand		•		•	•	•

Marina Beach Club

Tumbona apilable con caja de seguridad incorporada al chasis para guardar objetos de forma segura. Se cierra con un tapa plástica muy resistente y hermética, y con un candado de acero inoxidable. La tumbona Marina Beach Club está disponible con tejido Club de 850g/m2.

Stackable sunlounger. Polypropylene and fiberglass frame. Textilene 850 gr/m2, thermal bonding, to improve resistance, double linen weft and warp. UV protection. Wheels under back legs and non-slip end-plates under front and back legs. Glass holder. Four-position reclining sunlounger.

Bain de soleil empilable avec structure en polypropylene et fibre de verre. Textilène de 850 gr/m2, termosoudé pour une résistance meilleure, et double chaîne et du fil de trame et ourdir. Pieds arrière munis de roues et pieds avant et arrière munis de patins antidérapants, avec repose-verres. 4 positions du dossier.



Upholstered	Structure	Wengué	Gris Plata	Marfil	Gris Oscuro	Blanco
		Wenge	Grey silver	Ivory	Dark Grey	White
Azul Blue						•
Naranja Orange						•
Beige Beige				•	•	•
Blue Jeans Blue Jeans			•			•
Chocolate Chocolate		•				

Logística | Logistics | Logistique

	20'	40'	40' HC	70 m3	100 m3
2X	-	144	-	200	-
P25	-	450	-	525	-
P27	243	486	486	540	-

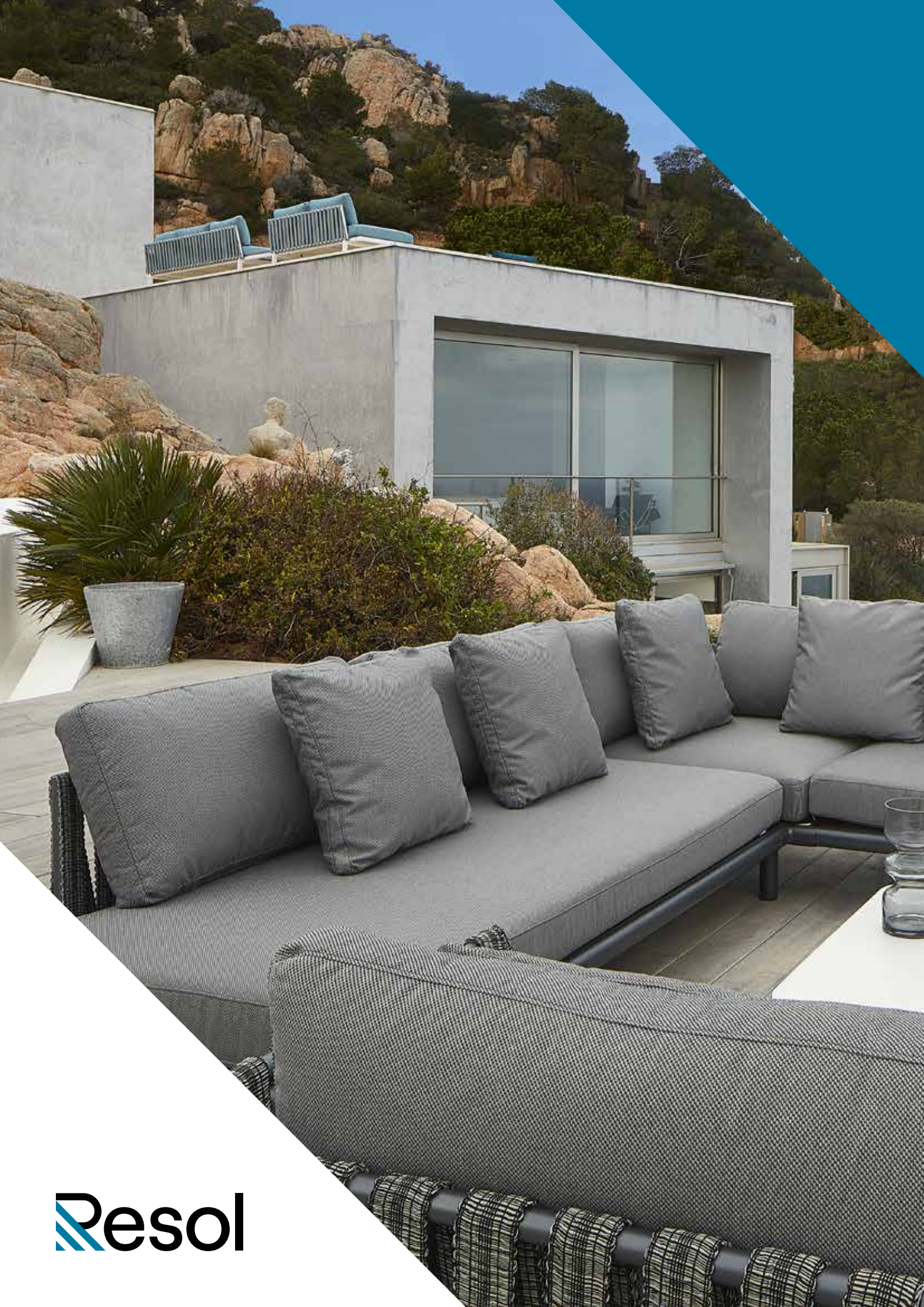

 Resol

Anthea

Combinaciones de colores

Color combinations

Combinaisons de couleurs



Anthea

Combinaciones

Combinations / Combinaisons

forest

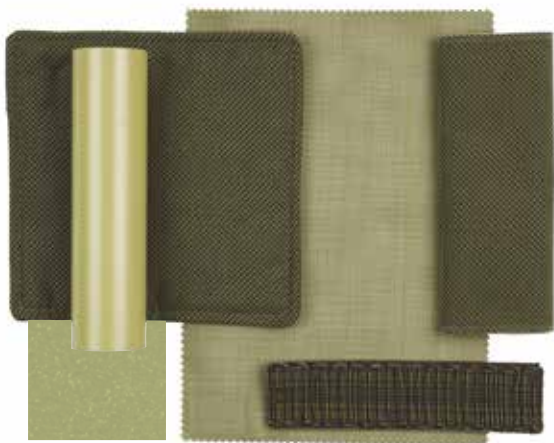

ocean

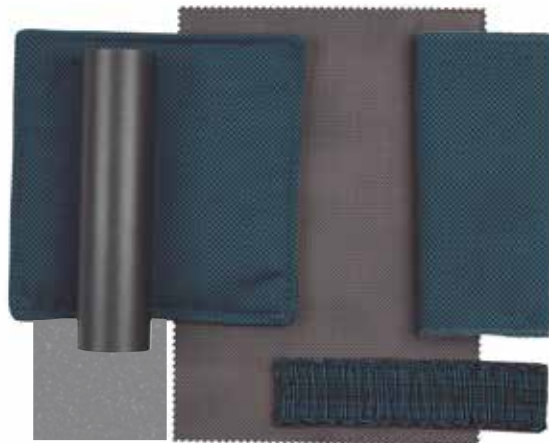

grove

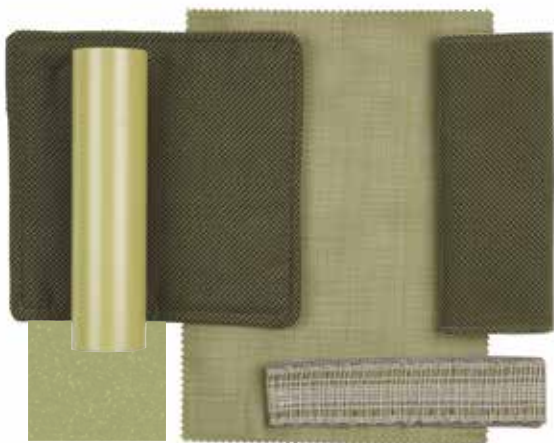

plumet



garden



storm



marine



dahlia



sky

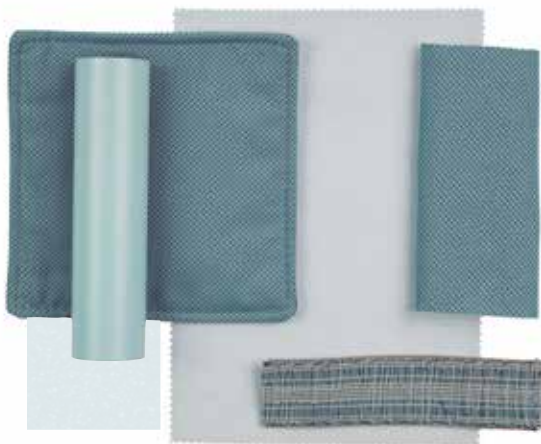

garnet

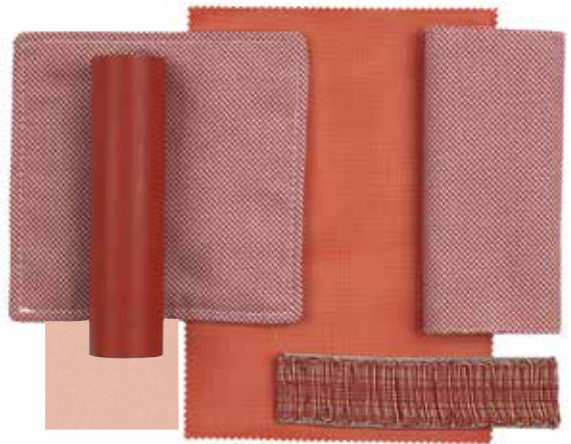

stream

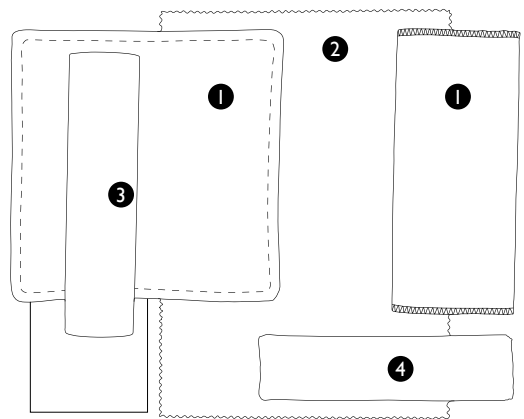
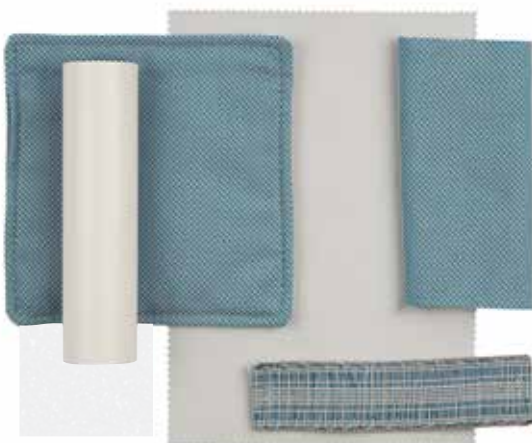

- 1. TEJIDO COJINES
CUSHION FABRIC
- 2. BATYLINE
BATYLINE
- 3. ESTRUCTURA
STRUCTURE
- 4. PASAMANERÍA
TRIMMINGS
- 5. TABLERO MESAS
TABLE TOPS

Estructura

Structure / Structure



RESISTENTE
A RAYOS UV

RESISTANT
TO UV RAYS



RESISTENTE
AL EXTERIOR

RESISTANT
TO WEATHER



antracita
anthracite



blanco
white



verde claro
light green



azul claro
light blue



rojo
red

La estructura puede ser en aluminio o en acero inoxidable. Consultar modelo.

The structure can be aluminium or stainless steel. Consult model.

Pasamanería

Trimmings / Passementerie



RESISTENTE
A RAYOS UV

RESISTANT
TO UV RAYS



RESISTENTE
AL EXTERIOR

RESISTANT
TO WEATHER



blanco y negro
black and white



azul claro
light blue



verde claro
light green



azul oscuro y negro
dark blue and black



rojo
red



verde oscuro y negro
dark green and black

Tejido cojines

Fabric cushions / Coussins en tissu



LA FUNDA INTERIOR DEL COJÍN ES HIDRÓFUGA | THE INNER COVER OF THE CUSHION IS DAMP PROOF



RESISTENTE A RAYOS UV | RESISTANT TO UV RAYS



RESISTENTE AL EXTERIOR | RESISTANT TO WEATHER



blanco y negro
black and white



azul claro
light blue



verde oscuro
dark green



azul oscuro y negro
dark blue and black



rojo
red

Accesorios / accessories / accessoires



Cojín rectangular / Rectangular cushion

65 x 29 x 12 cm

25.6 x 11.4 x 4.7 inch

Cojín / Cushion:

43 x 43 x 12 cm

7 x 17 x 4.7 inch

Batyline / Batyline



RESISTENTE A RAYOS UV | RESISTANT TO UV RAYS



RESISTENTE AL EXTERIOR | RESISTANT TO WEATHER

Serge Ferrari

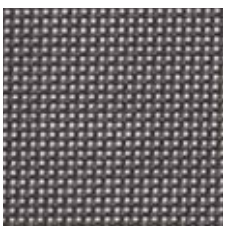

negro
black



blanco
white

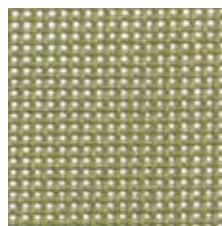

verde
green

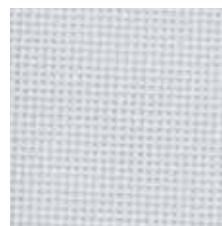

azul claro
light blue

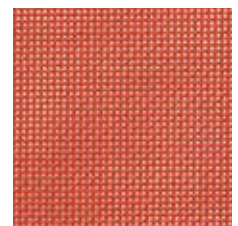

rojo
red

Tablero mesas

Table top / Dessus de la table



RESISTENTE A RAYOS UV



RESISTENTE AL EXTERIOR

fenolic



F1535 - Gris
F1535 - Grey

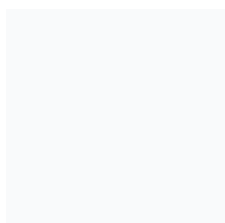

F2696 - Blanco
F2696 - White



F3007 - Verde claro
F3007 - Light green

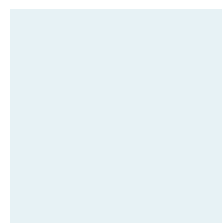

F5493 - Azul claro
F5493 - Light blue



0019FH - Rojo claro
0019FH - Light red



 Resol

Tapizados

Upholstered

Tapissé



COLECCIÓN SHAPE | SHAPE COLLECTION

by Josep Llusçà



4 PATAS

4 Legs
4 Pieds



PATÍN

Sled Base
Base Luge



PATAS ARAÑA

Spider Legs
Pattes d'Araignée



PATAS ARAÑA GIRATORIA

Swivel Spider Legs
Pattes d'Araignée Pivot



RUEDAS

Castors
À Roulettes



MADERA

Wood
Bois



CLICK

Click
Click

Combinaciones estructura + colores

Structure + color combinations

4 PATAS | 4 LEGS | 4 PIEDS



Estructura en acero pintado.
Structure made of painted steel.
Structure en acier peint.

COLORES ESTRUCTURA | STRUCTURE COLORS | COULEURS DU STRUCTURE



Blanco
White



Negro
Black



Gris Oscuro
Dark Grey



Arena
Sand



Toscano
Tuscan



Gris Verdoso
Green Grey



Azul Retro
Retro Blue

PATÍN | SLED BASE | BASE LUGE

PATAS ARAÑA | SPIDER LEGS | PATTES D'ARAIGNÉE



Estructura en acero pintado.
Structure made of painted steel.
Structure en acier peint.

COLORES ESTRUCTURA | STRUCTURE COLORS | COULEURS DU STRUCTURE



Blanco
White



Cromado
Chromed



Gris Oscuro
Dark Grey



Arena
Sand



Toscano
Tuscan



Gris Verdoso
Green Grey



Azul Retro
Retro Blue



PATAS ARAÑA GIRATORIA | SWIVEL SPIDER LEGS | PATTES D'ARAIGNÉE PIVOT

RUEDAS | CASTORS | À ROULETTES



Estructura de las patas en aluminio pintado.
Structure made of painted aluminium.
Structure en aluminium peint.

Estructura de patas con ruedas y elevador a gas.
Swivel base with casters and gas lift.
Chaise avec roulettes et vérin à gaz.

COLORES ESTRUCTURA | STRUCTURE COLORS | COULEURS DU STRUCTURE



Blanco
White



Negro
Black



MADERA | WOOD | BOIS



Patas de madera de haya y estructura de polipropileno.

Beech wood legs and polypropylene structure.

Pieds en bois de hêtre et structure en polypropylène.

COLORES ESTRUCTURA | STRUCTURE COLORS | COULEURS DU STRUCTURE



Base Gris Oscuro
Base Dark Grey
Base Gris Foncé



Patas de Haya
Beech Legs
Pieds du Hêtre

CLICK | CLICK | CLICK



Carcasa y estructura inyectada en polipropileno con fibra de vidrio.

Seat and structure injected in polypropylene and fiberglass.

Siège et structure injectée en polypropylène avec fibre de verre.

COLORES ESTRUCTURA | STRUCTURE COLORS | COULEURS DU STRUCTURE



Blanco
White



Gris Oscuro
Dark Grey



Marfil
Ivory



Chocolate
Chocolate



COLECCIÓN SKIN | SKIN COLLECTION

by Josep Llusçà



4 PATAS
4 Legs / 4 Pieds



PATÍN
Sled Base / Base Luge



RUEDAS
Castors / À Roulettes



PATAS ARAÑA
Spider Legs
Pattes D'araignée



PATAS ARAÑA GIRATORIA
Swivel Spider Legs
Pattes D'araignée Pivot



MADERA
Wood / Bois



CLICK
Click / Click



TABURETE PATÍN
Sled Base Stool
Tabouret Pied Central



TABURETE CENTRAL
Central stool
Tabouret Patin

ACCESORIOS*

Accessories | Accessoires

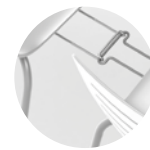

Varilla unión sillas
Rod to link accessory
Branche union chaise



Mesa auxiliar
Auxiliary table
Table d'appoint



Carro porta sillas
Trolley for chairs
Chariot porte-chaises

*Accesorios para 4 patas y patín.

Mesa Auxiliar solo para 4 patas.

*Accessories for 4 legs and sled base.

Auxiliary table only for 4 legs.

*Accessoires pour 4 pieds et base luge.

Table d'appoint pour 4 pieds seulement.

Combinaciones estructura + colores

Structure + color combinations

4 PATAS | 4 LEGS | 4 PIEDS



Estructura en acero pintado.
Structure made of painted steel.
Structure en acier peint.



Apilable
Stackable
Empilable

COLORES ESTRUCTURA | STRUCTURE COLORS | COULEURS DU STRUCTURE



Blanco
White



Negro
Black



Gris Oscuro
Dark Grey



Arena
Sand



Toscano
Tuscan



Gris Verdoso
Green Grey



Azul Retro
Retro Blue

PATÍN | SLED BASE | BASE LUGE



Estructura en acero pintado.
Structure made of painted steel.
Structure en acier peint.



Apilable
Stackable
Empilable

COLORES ESTRUCTURA | STRUCTURE COLORS | COULEURS DU STRUCTURE



Blanco
White



Cromado
Chromed



Gris Oscuro
Dark Grey



Arena
Sand



Toscano
Tuscan



Gris Verdoso
Green Grey



Azul Retro
Retro Blue

ACCESORIOS PARA 4 PATAS Y PATÍN

ACCESSORIES FOR 4 LEGS AND SLED BASE | ACCESSOIRES POUR 4 PIEDS ET BASE LUGE



Mesa auxiliar
Auxiliary table
Table d'appoint



Blanco
White



Negro
Black

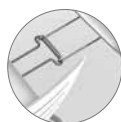

Varilla unión sillas
Rod to link accessory
Branche union chaise



Cromado
Chromed



Carro porta sillas
Trolley for chairs
Chariot porte-chaises



Cromado
Chromed

PATAS ARAÑA | SPIDER LEGS | PATTES D'ARAIGNÉE

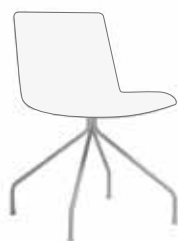

Estructura en acero pintado.
Structure made of painted steel.
Structure en acier peint.



Apilable
Stackable
Empilable

COLORES ESTRUCTURA | STRUCTURE COLORS | COULEURS DU STRUCTURE



Blanco
White



Cromado
Chromed



Gris Oscuro
Dark Grey



Arena
Sand



Toscano
Tuscan



Gris Verdoso
Green Grey



Azul Retro
Retro Blue

PATAS ARAÑA GIRATORIA | SWIVEL SPIDER LEGS | PATTES D'ARAIGNÉE PIVOT



Estructura de las patas en aluminio pintado.

Structure made of painted aluminium.

Structure en aluminium peint.

COLORES ESTRUCTURA | STRUCTURE COLORS | COULEURS DU STRUCTURE



Blanco
White



Negro
Black

RUEDAS | CASTORS | À ROULETTES



Estructura de patas con ruedas y elevador a gas.

Swivel base with casters and gas lift.

Chaise avec roulettes et vérin à gaz.

COLORES ESTRUCTURA | STRUCTURE COLORS | COULEURS DU STRUCTURE



Negro
Black

MADERA | WOOD | BOIS



Patas de madera de haya y estructura de polipropileno.

Beech wood legs and polypropylene structure.

Pieds en bois de hêtre et structure en polypropylène.

COLORES ESTRUCTURA | STRUCTURE COLORS | COULEURS DU STRUCTURE



Base Gris Oscuro
Base Dark Grey
Base Gris Foncé



Patas de Haya
Beech Legs
Pieds du Hêtre

CLICK | CLICK | CLICK



Carcasa y estructura inyectada en polipropileno con fibra de vidrio.

Seat and structure injected in polypropylene and fiberglass.

Siège et structure injectée en polypropylène avec fibre de verre.

COLORES ESTRUCTURA | STRUCTURE COLORS | COULEURS DU STRUCTURE



Blanco
White



Gris Oscuro
Dark Grey



Marfil
Ivory



Chocolate
Chocolate

TABURETE PATÍN | SLED BASE STOOL | TABOURET PIED CENTRAL TABURETE CENTRAL | CENTRAL STOOL



Estructura de acero pintado.

Structure made of painted steel.

Structure en acier peint.

COLORES ESTRUCTURA | STRUCTURE COLORS | COULEURS DU STRUCTURE



Blanco
White



Cromado
Chromed

TEJIDOS | FABRICS | TISSUS

Colección de tejidos y colores cuidadosamente seleccionados para afrontar cualquier proyecto de interior. Ésta colección nos permite ofrecer nuestra gama de sillas tapizadas sin cantidad mínima de compra y disponer de un plazo de entrega rápido de solamente 3 semanas.

Para otros tejidos fuera de nuestra colección, ofrecemos una amplia selección de gamas complementarias. Esta selección está sujeta a cantidades mínimas de compra y plazos de entrega distintos. También ofrecemos la posibilidad de tapizar nuestra colección de sillas con tejidos cliente u otras gamas. Consultar condiciones especiales con nuestro equipo comercial.

Collection of carefully selected fabrics and colours to tackle any interior design project. This collection enables us to offer our range of upholstered chairs without a minimum purchase amount and has a fast delivery deadline of only three weeks.

For other fabrics not included in our collection, we offer a broad selection of complementary ranges. This selection is subject to minimum purchase amounts and different delivery deadlines. We also offer the chance to upholster our collection of chairs with clients' fabrics or other ranges. Consult the special terms and conditions with our sales team.

Collection de tissus et couleurs soigneusement sélectionnés pour répondre à tous les projets de décoration d'intérieur. Cette collection nous permet de proposer notre gamme de chaises tapissées sans quantité minimale d'achat avec un délai rapide de livraison de 3 semaines seulement.

Pour d'autres tissus d'ameublement hors collection, un large choix de tissus complémentaires est disponible. Cette sélection est sujette à des quantités minimales d'achat avec des délais de livraison différents. Nous proposons également la possibilité de tapisser notre collection de chaises avec les tissus des clients ou avec d'autres gammes. Consulter les conditions spéciales avec notre équipe commerciale.



camira ERA

G.3

Composición

100% Poliéster
Tintes no metálicos.

Composition

100% Polyester
Non metallic dyestuffs

Composition

100% Polyester
Teintures non métalliques

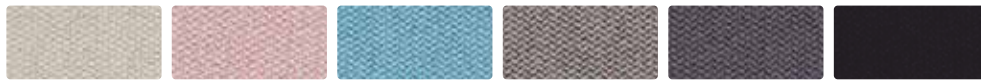

Futurist
CSE01

Calendar
CSE19

Aeon
CSE20

Generation
CSE02

Present
CSE13

Forward
CSE14

camira RIVET

G.3

Composición

100% REPREVE®
Poliéster Reciclado

Composition

100% REPREVE®
Recycled Polyester

Composition

100% REPREVE®
Polyester Recyclé.



Copper
EGL14

Tungsten
EGL07

Verdigris
EGL21

Vitreous
EGL01

Twig
EGL49

camira LIBRA

G.4

Composición

50%PP 32%PES 18%CO

Composition

50%PP 32%PES 18%CO

Composition

50%PP 32%PES 18%CO



05

22

41

47

52

59

camira STEP

G.5

Composición

100% Trevira cs

Composition

100% Trevira cs

Composition

100% Trevira cs



61149

60090

62057

68158

68161

60999

SPRADLING® VALENCIA

G.5

Composición

Capa: 100% Vinilo
Soporte: 100% Poliéster
Hi_loft 2TM

Composition

Topcoat: 100% Vinyl
Backing: 100% Polyester
Hi_loft 2TM

Composition

Face enduction: 100%
Vinyl. Support: 100%
Polyester Hi_loft 2TM



Leinen
107-1049

Warm Grey
107-4044

Camel
107-2116

Moss
107-5002

Titan
107-4042

Olive
107-5001

Night
107-2108

Schwarz
107-9035

Tapicerías | Fabrics | Tissus

camira ERA



Composición

100% Poliéster
Tintes no metálicos.
*Tratamiento CAMIRA STAY SAFE bajo condiciones especiales.

Composition

100% Polyester
Non metallic dyestuffs
*CAMIRA STAY SAFE treatment under special conditions.

Composition

100% Polyester
Teintures non métalliques
* Traitement CAMIRA STAY SAFE sous conditions spéciales.

camira RIVET



Composición

100% REPREVE®
Poliéster Reciclado
*Tratamiento CAMIRA STAY SAFE bajo condiciones especiales.

Composition 100%

REPREVE®
Recycled Polyester
*CAMIRA STAY SAFE treatment under special conditions

Composition

100% REPREVE® Polyester Recyclé.
* Traitement CAMIRA STAY SAFE sous conditions spéciales.

camira XTREME



Composición

100% Poliéster Reciclado Postconsumo.
Medium Hazard B1
*Tratamiento CAMIRA STAY SAFE bajo condiciones especiales.

Composition

100% Recycled Polyester Postconsume.
Medium Hazard B1
*CAMIRA STAY SAFE treatment under special conditions.

Composition

100% Polyester Recyclé Post-consommation.
Medium Hazard B1
* Traitement CAMIRA STAY SAFE sous conditions spéciales.

crevin LIBRA



Composición

50%PP 32%PES 18%CO

Composition

50%PP 32%PES 18%CO

Composition

50%PP 32%PES 18%CO

Gabriel® STEP



Composición

100% Trevira cs
Medium Hazard

Composition

100% Trevira cs
Medium Hazard

Composition

100% Trevira cs
Medium Hazard

SPRADLING® VALENCIA



Composición

Capa: 100% Vinilo
Soporte: 100% Poliéster
Hi_loft 2™

Composition

Topcoat: 100% Vinyl
Backing: 100% Polyester
Hi_loft 2™

Composition

Face enduction: 100% Vinyl.
Support: 100% Polyester
Hi_loft 2™

* Para más información consultar especificaciones técnicas de fabricante.
For further information consult the manufacturer's technical specifications.
Pour plus d'informations, consultez les spécifications techniques du fabricant.



Gabriel® MEDLEY



Composición
100% Poliéster

Composition
100% Polyester

Composition
100% Polyester

Gabriel® CONNECT



Composición
48% Lana
41% PES Postconsumo
9% PA
2% PES

Composition
48% Wool
41% PES Postconsume
9% PA
2% PES

Composition
48% Laine
41% PSE post-consommation
9% PA
2% PES

crevin® DROM



Composición
75% PES
25% PP

Composition
75% PES
25% PP

Composition
75% PES
25% PP

Gabriel® STEP MELANGE



Composición
100% Trevira cs

Composition
100% Trevira cs

Composition
100% Trevira cs

SPRADLING® SILVERTEX



Composición
Capa: 100% Vinilo
Soporte: 100% Poliéster Hi_loft 2TM

Composition
Topcoat: 100% Vinyl
Backing: 100% Polyester
Hi_loft 2TM

Composition
Face enduction: 100% Vinyl.
Support: 100% Polyester
Hi_loft 2TM

crevin® VELVETY



Composición
91% PES
9% CO

Composition
91% PES
9% CO

Composition
91% PES
9% CO

RECICLADO | RECYCLED | RECYCLÉ

CONTRACT | CONTRACT | CONTRACT

HOGAR | HOME | USAGE DOMESTIQUE

LAVABLE CON DISOLUCIÓN DE LEJÍA* | CLEANABLE WITH BLEACH SOLUTION* | LAVABLE AVEC DISSOLUTION D'EAU DE JAVEL*

CIGARRILLO Y CERILLA | CIGARRETE & MATCH | CIGARETTE ET ALLUMETTE

CIGARRILLO | CIGARRETE | CIGARETTE

GUÍA DE COLORES DE PP RESOL

RESOL'S PP COLOR GUIDE

GUIDE DES COULEURS DE PP RESOL

COLOR	PANTONE	RAL
 Blanco White Blanc		RAL 9016
 Negro Black Noire		RAL 9005
 Rojo Red Rouge	Pantone 485C	
 Verde Oliva Olive Green Vert Olive	Pantone 5777C	
 Chocolate Chocolate Chocolat	Pantone Warm Gray 11C	RAL 7006
 Arena Sand Sable	NSC S 5010- Y 10 R	RAL 1019
 Gris Oscuro Dark Grey Gris Foncé	Pantone 425C	RAL 7024
 Naranja Orange Orange	Pantone 1505C	
 Verde Lima Lime Green CitronVert	Pantone 396C	
 Rosa Pink Rose	Pantone 230C	
 Azul Cielo Light Blue Bleu Ciel	Pantone 543C	
 Azul Retro Retro Blue Bleu Rétro	Pantone 7697C	
 Melocotón Peach Pêche	Pantone 7579C	
 Caldera Red-orange Orangé Rouge	Pantone 718C	RAL 2001
 Gris Verdoso Green-grey Gris Vert	Pantone 7538C	RAL 7033
 Marfil Ivory Ivoire		RAL 1013
 Fucsia Fuchsia Fuchsia	Pantone 214C	
 Aquamint Aquamint Aquamint	Pantone 2253C	
 Vainilla Vanilla Vanille	Pantone 7499C	
 Toscano Tuscan Toscane	Pantone 7556 C	
 Turquesa Turquoise Turquoise	Pantone 5493C	
 Burdeos Burgundy Bordeaux		RAL 3004
 Terra cota Terracota Terracotta	Pantone 16-1526 TPX	

Estos colores son aproximados. Para tener referencias reales, pedir plaquetas de color al Departamento Comercial. Los colores y las imágenes son representativas y en ningún caso podrán ser motivo de reclamación.

These colors are approximate. For real references, ask for color swatches to the Commercial Department. The colours and images are representative and in any case can not be a reason for a complaint.



Ces couleurs sont approximatives. Pour avoir les références réelles, demander des échantillons de couleurs au département commercial. Les couleurs et les images sont représentatives et, en tout cas, ne peuvent pas être à l'origine de plaintes.



Ctra. Santa Coloma, km 46
Les Preses - 17178 Girona
(+34) 972 69 47 00

OFICINAS COMERCIALES
C/ Anselm Clavé, 224
Edificio FIGUERAS · planta 2
Lliçà d'Amunt - 08186 Barcelona
(+34) 93 844 50 50

resol@resol.es
www.resol.es

 /Resol
 /Resol_furniture
 /Resolgrupo