

The Lacor logo features a stylized white swoosh above the brand name 'Lacor' in a bold, italicized sans-serif font.

Brand of the Stars · Since 1949



Professional · Hotel · Restaurant

# 2023



“Brand of the stars”



## Liderazgo · Leadership · Leadership

---

***Somos una marca referencia dentro del sector de la hostelería y menaje doméstico. Tras años de esfuerzo nos hemos ganado una posición de liderazgo y nos hemos convertido en un referente en el sector.***

Nous sommes une marque de référence dans le secteur de l'hôtellerie et des articles ménagers. Après de nombreuses années d'efforts, nous avons atteint une position de leadership et avons pu devenir une référence dans le secteur.

Lacor is a leading brand within the hospitality and catering and houseware sectors. After years of effort the company has earned a leadership position and has become a reference in the sector.

## Tradición · Tradition · Tradition

---

***Pertenece a una tierra de profundas raíces gastronómicas, donde nuestros artesanos comenzaron a fabricar las primeras cazuelas hace 70 años. Hoy día mantene-mos el mismo espíritu y pasión por nuestra propia historia.***

Nous sommes issus d'une région aux profondes racines gastronomiques, où nos artisans ont commencé à fabriquer les premières casseroles il y a 70 ans. Nous conservons aujourd'hui le même état d'esprit et la même passion pour notre propre histoire.

Lacor comes from lands with deep gastrono-mical roots, where its artisans began to manufacture their first casseroles 70 years ago. The same spirit and passion of this long history is still maintained today.



## Calidad · Qualité · Quality

---

***Integramos la cultura de calidad tanto en nuestros procesos de fabricación y productos como en la relación con nuestros clientes y colaboradores, lo cual nos ha permitido ganarnos su confianza a lo largo del tiempo.***

Nous intégrons la culture de la qualité aussi bien dans nos processus de fabrication et nos produits que dans la relation avec nos clients et collaborateurs, ce qui nous a permis de gagner leur confiance au fil du temps.

Lacor integrates a culture of quality into its manufacturing processes and products as well as in relationships with its customers and collaborators, which has enabled the company to earn their trust over time.

## Equipo humano · L'équipe · Team

---

***Lacor está compuesto por un equipo cualificado de personas con un alto grado de compromiso hacia el servicio. Gracias a nuestra dedicación conseguimos establecer relaciones duraderas y de confianza con nuestra clientela.***

Lacor est composé d'une équipe qualifiée de personnes hautement engagées envers le service. Grâce à notre dévouement, nous pouvons établir des relations durables et de confiance avec notre clientèle.

Lacor is made up of a qualified team of people with a high level of commitment towards service. Thanks to their dedication, the company establishes lasting relationships based on trust with its clientele.

## Empresa global · Entreprise globale · Global company

---

**Tenemos presencia en 90 países a lo largo de los 5 continentes. A través del esfuerzo de nuestros distribuidores hemos conseguido llegar a las cocinas profesionales y hogares de todo el mundo.**

Nous sommes présents dans 90 pays répartis sur les 5 continents. À travers les efforts de nos distributeurs, nous avons pu pénétrer dans les cuisines professionnelles et les foyers du monde entier.

Lacor is present in 90 countries on the five continents. Through the efforts of its distributors the company has reached professional kitchens and homes around the world.



---

### Europe

Andorra · Austria · Belgium · Bulgaria · Czech Republic  
Croatia · Cyprus · Denmark · Finland · France · Germany  
Greece · Holland · Hungary · Iceland · Ireland · Italy · Latvia  
Lithuania · Luxembourg · Macedonia · Montenegro · Poland  
Portugal · Romania · Russia · Serbia · Slovenia · Spain  
Sweden · Switzerland · Turkey · UK+ N. Ireland · Ukraine

---

### Asia

Azerbaijan · Cambodia · China · Hong Kong · India · Indonesia  
Iran · Iraq · Israel · Japan · Jordan · Kazakhstan · Kuwait  
Lebanon · Macau · Malaysia · Philippines · Qatar · Russia  
Saudi Arabia · Singapore · South Korea · Sri Lanka · Taiwan  
Thailand · UAE · Vietnam

---

### America

Argentina · Bolivia · Brazil · Canada  
Chile · Colombia · Costa Rica · Cuba  
Dominican Rep. · French Guayana  
Guadalupe · Guatemala · Honduras  
Jamaica · Martinique · Mexico · Paraguay  
Peru · United States · Uruguay

---

### Oceania

Australia · New Zeland

---

### Africa

Algeria · Burkina Faso · Cape Verde  
Egypt · Ethiopia · Ivory Coast · Kenya  
Libya · Mauricio · Morocco  
Reunion Island · Senegal · Seychelles  
South Africa · Tunisia

## Condiciones generales de venta

---

Conditions générales de vente  
Allgemeine Geschäftsbedingungen  
General conditions of sale  
Condições gerais de venda



**ES**

- 1.- Los precios de la **presente tarifa** anulan los anteriores.
- 2.- En los precios están incluidos los **conceptos de embalaje**.
- 3.- El **medio de transporte** será a elección de esta Empresa. Cuando se desee el envío por un medio diferente al habitual de **LACOR**, los portes serán **DEBIDOS**.
- 4.- La forma de pago será mediante **GIRO DOMICILIADO** y el **plazo máximo** para el pago serán **60 días**. Otras formas de pago deberán ser autorizadas por la dirección de la Empresa.
- 5.- Todas las **devoluciones de mercancías** tienen que ser **autorizadas** por la Empresa. Las **devoluciones** que no sean por problemas de calidad deberán llegar a portes pagados y se abonarán al 90% del valor de la mercancía.
- 6.- Las **fotos, datos y medidas** que aparecen en este catálogo son indicativos y susceptibles, sin previo aviso, de modificación por exigencias técnicas o de producción.

Los portes serán **PAGADOS** a partir de los siguientes importes netos mínimos:

- a.- Península y Baleares: **300€**
- b.- Canarias, Ceuta y Melilla: **600€**
- c.- Francia y Alemania: **775€**
- d.- Reino Unido: **700€ / £600**
- e.- Benelux: **1.400€** e Irlanda: **1.200€**
- f.- Italia: **1.500€**
- g.- Para resto de países **consultar**

**FR**

- 1.- Les **présents tarifs** annulent les précédents.
- 2.- Dans les prix sont inclus les **concepts d'emballage**.
- 3.- Le **moyen de transport** sera au choix de cette entreprise. Si l'on désire l'envoi par un moyen différent à celui pratiqué habituellement par **LACOR**, les ports seront **DUS**.
- 4.- La forme de paiement sera par **LETRE DE CHANGE BANCAIRE** et le délai de paiement maximum sera de **60 jours**. D'autres formes de paiement devant être autorisées par la Direction de l'Entreprise.
- 5.- Tous les **retours de marchandises** doivent être **autorisés** par l'Entreprise. Les **retours** qui ne seront pas dus à des problèmes de qualité devront arriver avec les frais de ports payés et seront remboursés à 90% de la valeur de la marchandise.
- 6.- Les **photos, données et mesures** qui apparaissent dans ce catalogue sont à litre indicatif et sont susceptibles de modifications pour exigences techniques ou de production.

Les ports seront **PAYÉS** à partir des montants nets suivants de facture minimums:

- a.- Péninsule Ibérique et Baléares : **300€**
- b.- Canaries, Ceuta et Melilla : **600€**
- c.- France et Allemagne : **775€**
- d.- Royaume Uni : **700€ / £600**
- e.- Bénélux: **1.400€** et Irlande : **1.200€**
- f.- Italie : **1.500€**
- g.- Pour le reste des pays, prière de le **consulter**

**DE**

- 1.- Die Preise der **vorliegenden Preisliste** annullieren alle vorherigen.
- 2.- In den Preisen ist die **VerU.Ventaung** bereits enthalten.
- 3.- Das **Transportmittel liegt** im Ermessen dieses Unternehmens. Wenn der Versand durch ein bestimmtes Transportmittel gewünscht wird, das nicht mit dem bei **LACOR** üblichen übereinstimmt, werden die Transportkosten **IN RECHUNG GESTELLT**.
- 4.- Die Zahlungsform erfolgt per **EINZUGSVERFAHREN** und das Zahlungsziel beträgt **maximal 60 Tage**. Andere Zahlungsform müssen vor den Geschäftsleitung des Unternehmens genehmigt werden.
- 5.- Alle **Retouren von Ware müssen** von der Geschäftsleitung **bewilligt werden**. Die **Retouren**, die nicht Qualitätsprobleme betreffen, müssen mit gezahlten Portokosten geschickt werden. Es werden 90% des Warenwerts zurückerstattet.
- 6.- Die in diesem Katalog enthaltenen **Fotos, Informationen und Maße** sind beschreibender Art und können aufgrund technischer oder produktionsbezogener Erfordernisse ohne vorherige Ankündigung geändert werden.

Die Transportkosten werden ab folgenden Mindestnettorechnungsbeträgen von uns **ÜBERNOMMEN**:

- a.- Iberische Halbinsel und Balearen: **300€**
- b.- Kanaren, Ceuta und Melilla: **600€**
- c.- Frankreich und Deutschland: **775€**
- d.- Vereinigtes Königreich: **700€ / £600**
- e.- Benelux: **1.400€** und Irland: **1.200€**
- f.- Italien: **1.500€**
- g.- Für andere Länder **bitte anfragen**

**EN**

- 1.- **Current rate** prices cancel prior rates.
- 2.- **U.Ventaaging** is included in the prices.
- 3.- The **transportation method** shall be selected by this Company. When the delivery is requested through other means than the usual **LACOR**, freight be **DUE**.
- 4.- The payment method will be **DIRECT PAYMENT** and the payment terms will be a **maximum of 60 days**. Any other type of payment must be authorized by Company management.
- 5.- All **merchandise returns** must be **authorized** by the Company. **Returns** not made due to quality concerns must be delivered with freight paid and will be paid at 90% of the merchandise value.
- 6.- **Photos, information and measurements** that appear in this catalogue are for information and may be modified due to technical or production requirements at any time.

Freight shall be **PAID** from the following minimum invoice amounts:

- a.- Peninsula and Balearic: **300€**
- b.- Canary Islands, Ceuta and Melilla: **600€**
- c.- France and Germany: **775€**
- d.- United Kingdom: **700€ / £600**
- e.- Benelux: **1.400€** and Ireland: **1.200€**
- f.- Italy: **1.500€**
- g.- For all other countries, please **ask**

**PT**

- 1.- Os preços do **presente tarifário** anulam os anteriores.
- 2.- Nos preços estão incluídos as **taxas de embalagem**.
- 3.- O **meio de transporte** será à escolha desta Empresa. Quando se desajar o envio por um meio diferente do habitual da **LACOR**, os portes serão **BEVIDOS**.
- 4.- A forma de pagamento será a de **PAGAMENTO DOMICILIADO** e o **prazo máximo** para o pagamento será **60 dias**. Outras formas de pagamento deverão ser autorizadas pela Direção da Empresa.
- 5.- Todas as **devoluções de mercadorias** têm de ser **autorizadas** pela Empresa. As **devoluções** que não sejam devidas a problemas de qualidade deverão ser enviadas a portes pagos e serão pagas 90% do valor da mercadoria.
- 6.- As **fotografias, dados e dimensões** que constam deste catálogo são indicativos e suscetíveis, sem aviso prévio, de alteração por exigências técnicas ou de produção.

Os portes serão **PAGOS** a partir dos seguintes valores líquidos mínimos:

- a.- Península e Ilhas Baleares: **300€**
- b.- Ilhas Canárias, Ceuta e Melilha: **600€**
- c.- França e Alemanha: **775€**
- d.- Reino Unido: **700€ / £600**
- e.- Benelux: **1.400€** e Irlanda: **1.200€**
- f.- Itália: **1.500€**
- g.- Para o resto dos países, **consultar**

Materiales · Matériaux · Materials

<p><b>A</b> <b>Acacia</b> Bois d'acacia Acacia wood</p> <p><b>Acero cromado</b> Acier chromé Chrome steel</p> <p><b>Acrílico</b> Acrylique Acrylic</p> <p><b>Acrilonitrilo butadieno estireno (termoplástico)</b> Acrylonitrile Butadiène Styène (Thermoplastique) Acrylonitrile Butadiene Styrene (Thermoplastic)</p> <p><b>Aluminio</b> Aluminium Aluminium</p>	<p><b>Acacia</b> Wood</p> <p><b>Acero Cromado</b> Chrome steel</p> <p><b>ASA</b> Acrylic</p> <p><b>ABS</b> Plastic</p> <p><b>AL</b> Aluminium</p> <p><b>Bambú</b> Bamboo</p> <p><b>TPR</b> Plastic</p> <p><b>CE</b> Ceramic</p> <p><b>Cristal</b> Glass</p> <p><b>TPE</b> Plastic</p> <p><b>Fibra de vidrio</b> Fiberglass</p> <p><b>FO</b> Forjado Wrought</p> <p><b>FU</b> Fundido Cast</p> <p><b>Haya</b> Beech Wood</p> <p><b>FE</b> Iron</p> <p><b>Hierro colado</b> Cast Iron</p> <p><b>Inox</b></p> <p><b>Inox 18/10</b></p>	<p><b>M</b> <b>Madera de caucho</b> Bois de caoutchouc Rubber wood</p> <p><b>Material embutido</b> Matériel d'incrustation Inlaying material</p> <p><b>Melamina (trímero)</b> Mélamine (trimère) Melamine (trimer)</p> <p><b>N</b> <b>Nylon</b> Nylon Nylon</p> <p><b>P</b> <b>Pizarra natural 100%</b> 100% ardoise naturelle 100% natural Slate</p> <p><b>Plástico estireno acrilonitrilo</b> Plastique acrylonitrile styrène Acrylonitrile styrene plastic</p> <p><b>Plástico polimetilmetacrilato</b> Plastique polyméthacrylate de méthyle Polymethyl methacrylate plastic</p> <p><b>Policarbonato</b> Polycarbonate Polycarbonate</p> <p><b>Poliestireno (polímero termoplástico)</b> Polystyrène (polymère thermoplastique) Polystyrene (thermoplastic polymer)</p> <p><b>Polietileno (polímero)</b> Polyéthylène (polymère) Polyethylene (polymer)</p> <p><b>Polietileno de alta densidad (polímero)</b> Polyéthylène haute densité (polymère) High-density polyethylene (polymer)</p> <p><b>Polietileno de baja densidad (polímero)</b> Polyéthylène basse densité (polymère) Low density polyethylene (polymer)</p> <p><b>Polietileno de baja densidad (polímero)</b> Polyéthylène basse densité (polymère) Low density polyethylene (polymer)</p> <p><b>Polipropileno (polímero)</b> Polypropylène (polymère) Polypropylene (polymer)</p> <p><b>S</b> <b>Silicona</b> Silicone Silicone</p> <p><b>Z</b> <b>ZAMAK</b> ZAMAK ZAMAK</p> <p><b>Zirconia</b> Zircone Zirconia</p>	<p><b>Madera Caucho</b> Rubber wood</p> <p><b>Embutición</b> Deep Drawn</p> <p><b>MF</b> Melamine</p> <p><b>PA</b> Nylon</p> <p><b>Pizarra</b> Slate</p> <p><b>SAN</b> Plastic</p> <p><b>PMMA</b> Plastic</p> <p><b>PC</b> Polycarbon</p> <p><b>PS</b> Plastic</p> <p><b>PE</b> Polyethylene</p> <p><b>HPPE</b> Polyethylene</p> <p><b>PELD</b> Polyethylene</p> <p><b>LDPE</b> Polyethylene</p> <p><b>PP</b> Polypropylene</p> <p><b>Si</b> Silicone</p> <p><b>Zinc Alloy</b></p> <p><b>CZ</b> Zirconia</p>
<p><b>B</b> <b>Bambú</b> Bois de bambou Bamboo wood</p> <p><b>C</b> <b>Caucho termoplástico</b> Caoutchouc thermoplastique Thermoplastic rubber</p> <p><b>Cerámico</b> Céramique Ceramic</p> <p><b>Cristal</b> Verre Glass</p> <p><b>E</b> <b>Elastómero termoplástico</b> Élastomère thermoplastique Thermoplastic elastomer</p> <p><b>F</b> <b>Fibra de vidrio</b> Fibre de verre Fiberglass</p> <p><b>Forjado</b> Forgée Wrought</p> <p><b>Fundido</b> Fondu Cast</p> <p><b>H</b> <b>Haya</b> Bois de hêtre Beech wood</p> <p><b>Hierro</b> Fer Iron</p> <p><b>Hierro colado</b> Fonte Cast iron</p> <p><b>I</b> <b>Inoxidable</b> Acier inoxydable Stainless steel</p> <p><b>Inoxidable 18/10</b> Acier inoxydable 18/10 Stainless steel 18/10</p>			

<p><b>A</b> <b>Anodizado</b> Anodisé Anodized</p>		<p><b>Dureza del artículo</b> Dureté de l'article Item Hardness</p>	<p><b>87</b> HRc</p>
<p><b>Antiadherente libre de PFOA</b> Antiadhésif sans PFOA PFOA free non-stick</p>		<p><b>E</b> <b>Etiqueta ecológica para productos textiles</b> Label écologique pour les produits textiles Eco label for textile products</p>	
<p><b>Antiadherente</b> Antiadhésif Non-stick</p>		<p><b>F</b> <b>Fondo sandwich</b> Fond de sandwich Sandwich background</p>	
<p><b>Apto para el lavavajillas</b> Lave-vaisselle Dishwasher safe</p>		<p><b>I</b> <b>Instituto Técnico Español de Limpieza</b> Institut technique espagnol du nettoyage Spanish Technical Institute for Cleaning</p>	
<p><b>Apto para llama</b> Convient pour la flamme Suitable for flame</p>		<p><b>L</b> <b>Lavar con un trapo húmedo</b> Laver avec un chiffon humide Wash with a damp cloth</p>	
<p><b>Apto para el congelador</b> Va au congélateur Freezer safe</p>		<p><b>Libre de BPA</b> Sans BPA BPA free</p>	
<p><b>Apto para el horno</b> Va au four Oven safe</p>		<p><b>M</b> <b>Material blando y flexible</b> Matériau souple et flexible Soft and flexible material</p>	
<p><b>Apto para el microondas</b> Va au micro-ondes Microwave safe</p>		<p><b>Material ecológico</b> Matériel écologique Ecological material</p>	
<p><b>Artículo apilable</b> Article empilable Stackable item</p>		<p><b>Motor de corriente alterna</b> Moteur à courant alternatif Alternating current motor</p>	
<p><b>C</b> <b>Certificado de Conformidad Europea</b> Certificat de conformité européen European Certificate of Conformity</p>		<p><b>Motor de corriente continua</b> Moteur à courant continu Continuous current motor</p>	
<p><b>Certificado en gestión forestal y cadena de custodia</b> Certifié en gestion forestière et chaîne de contrôle Certified in forest management and chain of custody</p>		<p><b>N</b> <b>Nivel de protección al polvo y agua</b> Niveau de protection contre la poussière et l'eau Dust and water protection level</p>	<p><b>IP20</b></p>
<p><b>Certificado ISO 14001. Sist. de gestión ambiental</b> Certificat ISO 14001. Syst. gestion environnementale ISO 14001 certificate. Syst. environmental management</p>		<p><b>Nivel de temperatura máxima</b> Niveau de température maximum Maximum temperature level</p>	<p><b>200°C</b> max</p>
<p><b>Cocina eléctrica</b> Cuisinier électrique Electric cook</p>		<p><b>Nº de capas del antiadherente</b> Nombre de couches antiadhésives No. of non-stick layers</p>	<p><b>3</b> Capas/Layer</p>
<p><b>Cocina de gas</b> Cuisinière à gaz Gas cook</p>		<p><b>Nº de hojas que tiene el portamenú</b> Nombre de feuilles dans le support de menu Number of sheets in the menu holder</p>	<p><b>6/4/4</b></p>
<p><b>Cocina de inducción</b> Cuisinier à induction Induction cook</p>		<p><b>Normas creadas por Comités Técnicos de Normalización de la Asociación Española</b> Normes créées par les comités de normalisation technique de l'Association espagnole Standards created by the Technical Standardization Committees of the Spanish Association</p>	
<p><b>Cocina vitrocerámica</b> Cuisinier vitrocéramique Vitreoceramic cook</p>		<p><b>P</b> <b>Peso que puede aguantar el artículo</b> Poids que l'article peut contenir Weight the item can hold</p>	<p><b>120 Kg</b></p>
<p><b>Cocina saludable</b> Cuisine saine Healthy cooking</p>		<p><b>Prohibido transportar en avión</b> Interdit de transporter en avion Forbidden to transport by plane</p>	
<p><b>D</b> <b>Directiva 2011/65/UE de Restricción de ciertas Sust. Peligrosas</b> Directive 2011/65 / UE sur les restrictions de certaines substances dangereuses Directive 2011/65 / EU on Rest. of Certain Hazardous substances</p>		<p><b>S</b> <b>Sistema de gestión de la calidad para dispositivos médicos</b> Syst. de gestion de la qualité des dispositifs médicaux Quality management system for medical devices</p>	

**X** **Todo aquel icono de la lista de la leyenda que contenga un aspa en rojo significa que no es apto.**  
Toute icône de la liste contenant une croix rouge signifiera qu'elle ne lui convient pas.  
Jedes Symbol in der Legendenliste, das ein rotes Kreuz enthält, bedeutet, dass es nicht dafür geeignet ist.  
Any icon in the legend list that contains a red cross will mean that it is not suitable for it.  
Qualquer icone na lista de legendas que contenha uma cruz em vermelho, significa que não é adequado.







Batería **EASY**  
Battery

<< 56 >>



Cazo · Paellera **COCOTTE**  
Saucepan · Paella pans

<< 61 / 109 >>



Batería **MINI**  
Battery

<< 62 / 222 >>



Cacerola **MINI SMALT**  
Casselore

<< 63 >>



Olla a presión **SICURO**  
Pressure cooker

<< 71 >>



Sartén honda **CHEF-TRICAPA**  
Deep frying pan

<< 75 >>



Sartén honda **CHEF-TRICAPA**  
Deep frying pan

<< 77 >>



Sartén Blinis **ECO-PIEDRA**  
Frying pan Blinis

<< 82 >>



Plancha grill **TitanFull**  
Grill plaque

<< 84 >>



Sartén **ETERNITY**  
Frying pan

<< 85 >>



Sartenes **SUA**  
Frying pans

<< 87 >>



Sartén **JAVA**  
Frying pan

<< 88 >>



Rustidera **INTENSE**  
Roaster

<< 97 >>



Colección **PARIS · MILAN · LIMA**  
Collection

<< 100 >>



Reloj de **COCINA**  
Kitchen timer

<< 105 / 183 >>



Colección **GREY**  
Collection  
<< **123** >>



Colección **NATURAL/BLACK**  
Collection  
<< **124** >>



Colección **NORDIC**  
Collection  
<< **128** >>



Cacillo para salsa **PIZZA**  
Gravy ladle  
<< **129** >>



Espátulas **ACODADA**  
Bent spatules  
<< **133** >>



Rasqueta **3 en 1**  
Scraper  
<< **136 / 4675** >>



Colección **OCEAN**  
Collection  
<< **137 / 465** >>



Pala para **PATATAS FRITAS**  
Potato shovel  
<< **141** >>



Set de medición **EXACT**  
Measuring set  
<< **144 / 456** >>



Set de 4 boles **PRACTIC**  
Set of 4 bowls  
<< **144 / 456** >>



Set de 3 boles **GREY**  
Set of 3 bowls  
<< **145 / 458** >>



Set de 6 boles **MULTI**  
Set of 6 bowls  
<< **145 / 458** >>



Set de 3 boles **INOX**  
Set of 3 bowls  
<< **146 / 459** >>



Bol cónico **GARINOX**  
Conical mixing bowl  
<< **146 / 459** >>



Picadora manual **PRESS**  
Manual food chopper  
<< **154 / 334** >>



Garras de **OSO**  
Bear claws for meat  
« 155 / 335 »



Triturador manual de **TOMATE**  
Manual tomato chopper  
« 156 / 340 »



Centrifugadoras **MINI / KLEIN**  
Spinner  
« 165 »



Soporte para **BANDEJAS**  
Trays stand  
« 187 »



Cuberteros **RAPPAN PP**  
Cutlery holder  
« 213 / 369 / 390 »



Cestas **BAGUETTE**  
Baskets  
« 219 / 388 »



Cestillos **BLACK**  
Baskets  
« 230 »



Recipiente **MANTEQUILLA**  
Butter container  
« 239 »



Pinza Jumbo **SILICONA**  
Utility tong  
« 246 »



Colección pinzas **PRECISIÓN**  
Precision tong collection  
« 247 »



Colección **BBQ**  
Collection  
« 250 »



Cafeteras **COMPACT**  
Coffee maker  
« 254 / 576 »



Cafeteras **PRO**  
Coffee maker  
« 254 / 576 »



Cafeteras Express **MILAN / SINA**  
Express coffee  
« 257 »



Cafeteras **ALUMINIO**  
Express coffee  
« 258 »



Cafetera francesa **COPPER**  
French coffee maker

<< **259** >>



Jarra termo **WOOD**  
Thermo jug

<< **269** >>



Vasos **SERVE & GO**  
Tumbler

<< **273** >>



Funda enfriabotellas **NAVY**  
Bottle cooler cover

<< **277** >>



Cubo enfriabotellas **ARTIC**  
Vine bucket

<< **279** >>



Colección jarras  
Jug collection

<< **284** >>



Soportes jarra dispensadora  
Dispenser jug supports

<< **285** >>



Juego cocteleras  
Cocktail set

<< **290** >>



Cubitera **NORDIC**  
Ice bucket

<< **293** >>



Bomba vacío **LUXE**  
Vacuum pump

<< **298** >>



Ralladores 4 caras  
Utility tong4 faces graters

<< **341** >>



Macheta para **PESCADO**  
Fish cleaver

<< **351** >>



Bloque **MAGNET**  
Magnetic block

<< **353** >>



Tijeras aves **INOX**  
Poultry shears

<< **356** >>



Afilador cuchillos **TitanPro**  
Electric knife sharpener

<< **359 / 620** >>



Set 3 tablas de corte **BAMBÚ**  
Cutting board

<< **362** >>



Tabla de corte **COLLECT**  
Cutting board

<< **363** >>



Quesera **KEEP**  
Cheese dome

<< **364** >>



Set 3 tablas de corte **OCEAN**  
Cutting board

<< **365** >>



Cafetera **PERCOLADA**  
Coffee percolator

<< **381 / 573** >>



Papeleras **NATURE**  
Pedal bins

<< **447** >>



Portarrollos **BLACK**  
Dispenser

<< **449** >>



Baños María  
Bain marie

<< **480 / 554** >>



Colección **PLATINIUM**  
Collection

<< **490 / 491** >>



Moldes desmontables  
Dismountable mould

<< **498** >>



Arrocera **PROFESIONAL**  
Rice cooler

<< **506** >>



Cocedor huevos 3/6 **OVUM**  
4/6 eggs cooker

<< **507** >>



Cocedor/Asador **SALCHICHAS**  
Saucege cooler/roaster

<< **508** >>



Yogurteras **MAXI / HERA**  
Yoghurt makers

<< **511** >>



Picadora profesional **QUICK**  
Professional chopper

<< **527** >>



Procesador alimentos **MultiGenius**  
Food processor

<< 532 >>



Colección **FREIDORAS DE AIRE**  
AIR FRYER collection

<< 539 / 541 >>



Hornos **SOBREMESA**  
Counter ovens

<< 542 >>



Reclette **JOIN**  
Grill reclette

<< 550 >>



Chocolatera **CHOCOWEET**  
Chocolate machine

<< 555 >>



Calentador **BIBERONES**  
Squeezer bottle warmer

<< 559 >>



Exprimidor **VITALLY WHITE**  
Orange squeezer

<< 584 >>



Armarios **REFRIGERADORES**  
Thermo wine cooler

<< 611 / 612 >>







**Menaje**  
Cookware

---

**18**  
**Baterías domésticas**  
Household cookware

**31**  
**Baterías profesionales**  
Professional cookware

**68**  
**Ollas a presión**  
Pressure cookers

**73**  
**Sartenes**  
Frypans

**94**  
**Rustideras · Horno**  
Roasting pans · Oven

**106**  
**Paelleras**  
Paella pans



**Utensilios**  
Utensils

---

**112**  
**Juegos de cocina**  
Kitchen tools

**131**  
**Preparación**  
Food processing

**175**  
**Básculas · Termómetros**  
Scales · Thermometers



**Mesa**  
Table Top

---

**184**  
**Bandejas · Fuentes**  
Trays

**191**  
**Melamina**  
Melamine

**208**  
**Servicio mesa**  
Table service

**243**  
**Pinzas**  
Tongs

**251**  
**Cafetería**  
Cafeteria

**268**  
**Termos · Botellas**  
Thermos · Bottles

**278**  
**Bar · Bodega**  
Wine cellar

**307**  
**Portamenú**  
Portamenu



**Corte**  
Cutting

---

**328**  
**Corte**  
Cutting



**Buffet**  
Buffet

---

**370**

**Chafing dish + Buffet**  
Chafing dish + Buffet



**Gastronorm**  
Gastronorm

---

**406**

**Cubetas**  
Container

**418**

**Transporte · Estanterías**  
Transport · Shelves

**437**

**Cestas**  
Racks

**442**

**Limpieza**  
Cleaning



**Repostería**  
Pastry

---

**452**

**Preparación repostería**  
Pastry processing

**485**

**Moldes · Aros**  
Moulds · Rings



**Eléctrico**  
Electric

---

**502**

**Eléctrico**  
Electric

**625**

**Calentadores**  
Terrace heater

---

# Menaje

Cookware





**Baterías profesionales**  
Professional cookware

**Baterías domésticas**  
Household cookware

**Ollas a presión**  
Pressure cookers

**Sartenes**  
Frypans

**Rustideras · Horno**  
Roasting pans · Oven

**Paelleras**  
Paella pans

# Batería CHEF-LUXE

Inox  
18/10



Sandwich



Vitro



Electric



Gas



Induction



Oven



Dishwasher



- Toda la pieza (cuerpo, asas y mangos) fabricada en acero inoxidable 18/10.
- Fondo termodifusor (inox 18/10 - aluminio - inox).
- Espesor 1,5 - 2 mm.
- Tapas diseñadas para el ahorro energético.
- Máxima garantía en cuanto a resistencia, durabilidad e higiene.
- Apta para todos los tipos de cocina (incluida inducción y horno).

- Toute la pièce (corps, poignées et manches) est fabriquée en acier inoxydable 18/10.
- Fond thermo-diffuseur (Inox 18/10 - Aluminium - Inox).
- Épaisseur 1,5 - 2 mm.
- Couvercles conçus pour une économie d'énergie.
- Garantie maximale en termes de résistance, de durabilité et d'hygiène.
- Compatible avec tous les types de cuisinières (y compris induction et four).

- Ganzes Stück (Topf, Griffe und Stiele) aus rostfreiem Stahl 18/10.
- Wärmeleitender Boden (Edelstahl 18/10 - Aluminium - Edelstahl).
- 1,5 - 2 mm dick.
- Energieeffizient geformte Deckel.
- Garantiert robust, langlebig und hygienisch.
- Für alle Herdarten geeignet (inkl. Induktion und Ofen).

- The whole product (body, handles and grips) is made in 18/10 stainless steel.
- Heat diffuser bottom (18/10 stainless steel - Aluminium - Stainless).
- Thickness 1.5 - 2 mm.
- Covers designed for saving energy.
- Maximum guarantee in terms of resistance, durability and hygiene.
- Suitable for all types of cooking surfaces (including induction and the oven).

- Peça fabricada inteiramente (corpo, asas e mangos) em aço inoxidável 18/10.
- Fundo termodifusor (Inox 18/10 - Alumínio - Inox).
- Espessura 1,5 - 2 mm.
- Tampas concebidas para poupar energia.
- Máxima garantia de resistência, durabilidade e higiene.
- Apta para todos os tipos de fogões (incluindo placas de indução e forno).

## Cacerola con tapa

Faitout avec couvercle  
Bratentopf mit Deckel  
Casserole with lid  
Çaçarola com tampa

Ref	€	Ø (cm)	h (cm)	e (mm)	L	U.Venta
54020	83,50	20	10,0	1,5	2,90	1
54024	100,00	24	11,0	1,5	4,25	1
54028	116,00	28	11,0	1,5	6,70	1
54032	144,30	32	12,5	1,5	10,00	1
54036	175,30	36	14,0	1,5	14,20	1
54040	226,60	40	15,5	2,0	19,40	1
54045	269,40	45	17,0	2,0	27,00	1
* 54050	337,80	50	20,0	2,0	38,20	1

\* NO inducción · NOT induction

## Cacerola sin tapa

Faitout sans couvercle  
Bratentopf ohne Deckel  
Casserole without lid  
Çaçarola sem tampa

Ref	€	Ø (cm)	U.Venta
54020S	65,90	20	1
54024S	79,80	24	1
54028S	93,00	28	1
54032S	116,30	32	1
54036S	141,10	36	1
54040S	188,60	40	1
54045S	225,80	45	1
* 54050S	286,10	50	1

\* NO inducción · NOT induction



## Cacerola alta con tapa

Braisiere avec couvercle  
Fleischtopf mit Deckel  
Deep casserole with lid  
Çaçarola alta com tampa

Ref	€	Ø (cm)	h (cm)	e (mm)	L	U.Venta
54021	87,30	20	13,0	1,5	4,00	1
54025	108,50	24	14,0	1,5	6,70	1
54029	132,00	28	17,5	1,5	10,70	1
54033	154,40	32	18,0	1,5	14,60	1
54037	197,00	36	21,5	1,5	21,80	1
54041	255,90	40	24,5	2,0	30,00	1
54046	303,60	45	27,5	2,0	43,70	1
* 54051	400,60	50	30,0	2,0	58,80	1

\* NO inducción · NOT induction

## Cacerola alta sin tapa

Braisiere sans couvercle  
Fleischtopf ohne Deckel  
Deep casserole without lid  
Çaçarola alta sem tampa

Ref	€	Ø (cm)	U.Venta
54021S	69,60	20	1
54025S	88,40	24	1
54029S	109,20	28	1
54033S	126,30	32	1
54037S	162,90	36	1
54041S	217,90	40	1
54046S	260,00	45	1
* 54051S	348,80	50	1

\* NO inducción · NOT induction



### Olla con tapa

Marmite traiteur avec couvercle  
Suppentopf mit Deckel  
Casserole with lid  
Çaçarola scom tampa

Ref	€	Ø (cm)	h (cm)	e (mm)	L	U.Venta
54120	96,70	20	20,0	1,5	6,20	1
54124	117,70	24	24,0	1,5	10,50	1
54128	142,40	28	28,0	1,5	17,20	1
54132	193,10	32	32,0	1,5	25,70	1
54136	238,50	36	36,0	1,5	36,50	1
54140	297,20	40	40,0	2,0	50,00	1
54145	380,30	45	45,0	2,0	71,50	1
* 54150	537,30	50	50,0	2,0	98,00	1

\* NO inducción · NOT induction

### Olla recta sin tapa

Marmite traiteur s/couvercle  
Suppentopf ohne Deckel  
Stock Pot without lid  
Panela sem tampa

Ref	€	Ø (cm)	U.Venta
54120S	79,00	20	1
54124S	97,70	24	1
54128S	119,40	28	1
54132S	165,00	32	1
54136S	204,90	36	1
54140S	259,30	40	1
54145S	336,80	45	1
* 54150S	485,40	50	1

\* NO inducción · NOT induction



### Olla baja con tapa

Marmite basse avec couvercle  
Gemüsetopf mit Deckel  
Low casserole with lid  
Çaçarola baixa com tampa

Ref	€	Ø (cm)	h (cm)	e (mm)	L	U.Venta
54119	90,20	20	15,0	1,5	4,70	1
54123	110,80	24	20,0	1,5	9,00	1
54127	138,60	28	22,0	1,5	13,50	1
54131	181,50	32	26,0	1,5	20,00	1
54135	204,10	36	29,0	1,5	29,50	1
54139	278,30	40	32,0	2,0	40,00	1

### Olla baja sin tapa

Marmite basse s/couvercle  
Gemüsetopf ohne Deckel  
Low stock pot without lid  
Panela baixa sem tampa

Ref	€	Ø (cm)	U.Venta
54119S	73,40	20	1
54123S	90,60	24	1
54127S	115,50	28	1
54131S	153,30	32	1
54135S	170,10	36	1
54139S	240,20	40	1



### Paellera con tapa

Plat rond avec couvercle  
Pfanne mit Deckel  
Round dish with lid  
Paelheira com tampa

Ref	€	Ø (cm)	h (cm)	e (mm)	L	U.Venta
54636	169,50	36	7,0	1,5	7,00	1
54640	206,30	40	8,0	1,5	10,00	1
54645	238,90	45	8,5	2,0	12,00	1
* 54650	301,50	50	9,0	2,0	17,00	1

\* NO inducción · NOT induction

### Paellera sin tapa

Plat rond s/couvercle  
Pfanne ohne Deckel  
Round dish without lid  
Paelheira sem tampa

Ref	€	Ø (cm)	U.Venta
54636S	134,10	36	1
54640S	166,30	40	1
54645S	193,00	45	1
* 54650S	246,80	50	1

\* NO inducción · NOT induction



### Cazo recto

Casserole  
Stielkasserolle, flach  
Saucepan  
Çaçarola direite



Ref	€	Ø (cm)	h (cm)	e (mm)	L	U.Venta
54212	43,00	12	7,0	1,2	0,75	1
54214	45,50	14	7,5	1,2	1,10	1
54216	48,10	16	8,0	1,5	1,60	1
54218	52,70	18	9,0	1,5	2,25	1
54220	59,10	20	10,0	1,5	2,90	1
* 54224	77,80	24	10,0	1,5	4,25	1
* 54228	89,90	28	11,0	1,5	6,70	1

\* Con asa · With handle

### Cazo recto alto

Casserole haute  
Stielkasserolle  
Deep saucepan  
Çaçarola alta direite



Ref	€	Ø (cm)	h (cm)	e (mm)	L	U.Venta
54217	50,60	16	11,0	1,5	2,20	1
54219	59,20	18	12,0	1,5	3,00	1
54221	62,40	20	13,0	1,5	4,00	1
* 54225	89,10	24	14,0	1,5	6,70	1
* 54229	104,90	28	17,5	1,5	10,70	1

\* Con asa · With handle

### Cazo Francés

Casserole Française  
Stielkasserolle, französisch  
French saucepan  
Francês caçarola direita



Ref	€	Ø (cm)	h (cm)	e (mm)	L	U.Venta
54225N	76,30	24	12,0	1,5	5,40	1
54229N	97,90	28	14,0	1,5	8,60	1

### Cazo cónico

Sautase conique  
Sauteuse, Konisch  
Conical saute pan  
Caçarola cónica



Ref	€	Ø (cm)	h (cm)	e (mm)	L	U.Venta
55216	48,10	16	6,0	1,5	1,00	1
55220	53,10	20	6,5	1,5	1,60	1
55224	62,10	24	7,5	1,5	2,70	1

### Sautex

Sauteuse  
Sauteuse  
Sauteuse  
Frigideira



Ref	€	Ø (cm)	h (cm)	e (mm)	L	U.Venta
* 54621	57,40	20	6,5	1,5	1,80	1
54625	69,60	24	6,5	1,5	2,70	1
54629	85,60	28	7,0	1,5	4,00	1
54633	107,20	32	8,5	1,5	4,70	1
54637	129,20	36	10,0	1,5	7,00	1

\* Sin asa - Without handle

### Tapa

Couvercle  
Deckel  
Lid  
Tampa



Ref	€	Ø (cm)	U.Venta
54916	16,10	16	1
54920	17,40	20	1
54924	20,00	24	1
54928	22,70	28	1
54932	27,80	32	1
54936	33,70	36	1
54940	38,00	40	1
54945	43,60	45	1
54950	51,80	50	1

# Batería CHEF-CLASSIC

Inox  
18/10



Sandwich



Vidro



Electric



Gas



Induction



Oven



Dishwasher



- Toda la pieza (cuerpo, asas y mangos) fabricada en acero inoxidable 18/10.
- Fondo termodifusor (inox 18/10 - aluminio - inox). Espesor 0,7 - 1,2 mm.
- Tapas diseñadas para el ahorro energético.
- Apta para todos los tipos de cocina (incluida inducción y horno).
- \* Excepto Ø60 cm.
- Acabado mate interior y exterior.
- Máxima garantía en cuanto a resistencia, durabilidad e higiene.

- Toute la pièce (corps, poignées et manches) est fabriquée en acier inoxydable 18/10.
- Fond thermo-diffuseur (Inox 18/10 - Aluminium - Inox).
- Épaisseur 0,7 - 1,2 mm. Couverts conçus pour une économie d'énergie.
- Compatible avec tous les types de cuisinières (y compris induction et four).
- \* Excepté Ø60 cm.
- Finition mate intérieur et extérieur.
- Garantie maximale en termes de résistance, de durabilité et d'hygiène.

- Ganzes Stück (Topf, Griffe und Stiele) aus rostfreiem Stahl 18/10.
- Wärmeleitender Boden (Edelstahl 18/10 - Aluminium - Edelstahl).
- 0,7 - 1,2 mm dick. Energieeffizient geformte Deckel.
- Für alle Herdarten geeignet (inkl. Induktion und Ofen).
- \* mit Ausnahme von Ø60 cm.
- Innen und außen satiniert.
- Garantiert robust, langlebig und hygienisch.

- The whole product (body, handles and grips) is made in 18/10 stainless steel.
- Heat diffuser bottom (18/10 stainless steel - Aluminium - Stainless).
- Thickness 0.7 - 1.2 mm. Covers designed for saving energy.
- Suitable for all types of cooking surfaces (including induction and the oven).
- \* Except Ø60 cm.
- Interior and exterior matte finish.
- Maximum guarantee in terms of resistance, durability and hygiene.

- Peça fabricada inteiramente (corpo, asas e mangos) em aço inoxidável 18/10.
- Fundo Termodifusor (Inox 18/10 - Alumínio - Inox).
- Espessura 0,7 - 1,2 mm. Tampas concebidas para poupar energia.
- Apta para todos os tipos de fogões (incluindo placas de indução e forno).
- \* Excepto Ø60 cm.
- Acabamento mate interior e exterior.
- Máxima garantia de resistência, durabilidade e higiene.

## Cacerola con tapa

Faitout avec couvercle  
Bratentopf mit Deckel  
Casserole with lid  
Caçarola com tampa

Ref	€	Ø (cm)	h (cm)	e (mm)	L	U.Venta
50016	49,70	16	8,0	0,7	1,60	1
50020	59,10	20	9,0	0,7	2,80	1
50024	67,10	24	9,5	0,8	4,25	1
50028	92,70	28	11,0	0,8	6,75	1
50032	116,20	32	12,5	0,8	10,00	1
50036	155,40	36	14,0	1,0	14,20	1
50040	180,20	40	15,5	1,0	19,40	1
50045	212,30	45	17,0	1,0	27,00	1
50050	294,50	50	20,0	1,0	38,20	1
*50060	419,60	60	25,0	1,2	70,00	1

\* NO inducción · NOT induction

## Cacerola sin tapa

Faitout sans couvercle  
Bratentopf ohne Deckel  
Casserole without lid  
Caçarola sem tampa

Ref	€	Ø (cm)	U.Venta
50016S	39,30	16	1
50020S	45,60	20	1
50024S	52,30	24	1
50028S	75,90	28	1
50032S	93,80	32	1
50036S	128,60	36	1
50040S	149,80	40	1
50045S	176,00	45	1
50050S	250,00	50	1
*50060S	361,40	60	1

\* NO inducción · NOT induction



## Cacerola vapor

Panier vapeur  
Dampfkoch-Aussatz o/Untertopf  
Steam casserole  
Caçarola a vapor

Ref	€	Ø (cm)	h (cm)	e (mm)	U.Venta
50428	58,90	28	11,0	0,8	1
50432	65,00	32	12,5	0,8	1





## Cacerola alta con tapa

Braisiere avec couvercle  
Fleischtopf mit Deckel  
Deep casserole with lid  
Çaçarola alta com tampa

Ref	€	Ø (cm)	h (cm)	e (mm)	L	U.Venta
50017	51,40	16	11,0	0,7	2,20	1
50021	63,50	20	13,0	0,7	4,00	1
50025	73,40	24	14,0	0,8	6,75	1
50029	96,30	28	17,5	0,8	10,00	1
50033	120,70	32	18,0	0,8	14,40	1
50037	169,40	36	21,5	1,0	21,80	1
50041	199,70	40	24,5	1,0	30,70	1
50046	236,60	45	27,5	1,0	43,70	1
50051	331,00	50	30,0	1,2	58,80	1
*50061	477,30	60	35,0	1,2	98,00	1

\* NO inducción · NOT induction

## Olla recta con tapa

Marmite traiteur avec couvercle  
Suppentopf mit Deckel  
Stock pot with lid  
Panela com tampa

Ref	€	Ø (cm)	h (cm)	e (mm)	L	U.Venta
50116	55,10	16	16,0	0,8	3,20	1
50120	70,40	20	20,2	0,8	6,20	1
50124	88,60	24	24,0	0,8	10,50	1
50128	121,00	28	28,0	1,0	17,20	1
50132	171,50	32	32,0	1,0	25,70	1
50136	208,00	36	36,0	1,0	36,60	1
50140	248,90	40	40,0	1,2	50,00	1
50145	319,60	45	45,0	1,2	68,30	1
50150	500,70	50	50,0	1,2	98,00	1
*50160	703,20	60	50,0	1,2	141,00	1

\* NO inducción · NOT induction

## Olla baja con tapa

Marmite basse a/couvercle  
Gemüsetopf mit Deckel  
Low stock pot with lid  
Panela baixa com tampa

Ref	€	Ø (cm)	h (cm)	e (mm)	L	U.Venta
50119	63,00	20	15,0	0,8	4,70	1
50123	84,20	24	20,0	0,8	9,00	1
50127	109,90	28	22,0	0,8	13,50	1
50131	160,10	32	26,0	1,0	20,80	1
50135	185,90	36	29,0	1,0	29,50	1
50139	234,60	40	32,0	1,2	40,00	1

## Paellera con tapa

Plat rond a/couvercle  
Pfanne mit Deckel  
Round with lid  
Paelheira com tampa

Ref	€	Ø (cm)	h (cm)	e (mm)	L	U.Venta
50624	63,00	24	6,0	0,8	2,70	1
50628	85,20	28	6,0	0,8	3,60	1
50632	110,20	32	6,0	0,8	5,00	1
50636	139,30	36	7,0	1,0	7,10	1
50640	160,60	40	8,0	1,0	10,00	1
50645	188,60	45	8,5	1,0	13,50	1
50650	244,60	50	9,0	1,0	17,60	1
*50660	353,80	60	9,0	1,0	25,40	1

\* NO inducción · NOT induction

## Cacerola alta sin tapa

Braisiere sans couvercle  
Fleischtopf ohne Deckel  
Deep casserole without lid  
Çaçarola alta sem tampa

Ref	€	Ø (cm)	U.Venta
50017S	41,10	16	1
50021S	50,00	20	1
50025S	59,90	24	1
50029S	79,50	28	1
50033S	103,90	32	1
50037S	142,60	36	1
50041S	172,90	40	1
50046S	200,30	45	1
50051S	294,70	50	1
*50061S	419,10	60	1

\* NO inducción · NOT induction

## Olla recta sin tapa

Marmite traiteur s/couvercle  
Suppentopf ohne Deckel  
Stock Pot without lid  
Panela sem tampa

Ref	€	Ø (cm)	U.Venta
50116S	44,80	16	1
50120S	57,00	20	1
50124S	73,80	24	1
50128S	104,10	28	1
50132S	149,10	32	1
50136S	181,20	36	1
50140S	218,40	40	1
50145S	283,30	45	1
50150S	456,10	50	1
*50160S	644,90	60	1

\* NO inducción · NOT induction

## Olla baja sin tapa

Marmite basse s/couvercle  
Gemüsetopf ohne Deckel  
Low stock pot without lid  
Panela baixa sem tampa

Ref	€	Ø (cm)	U.Venta
50119S	49,60	20	1
50123S	69,40	24	1
50127S	93,00	28	1
50131S	137,70	32	1
50135S	159,10	36	1
50139S	204,20	40	1

## Paellera sin tapa

Plat rond s/couvercle  
Pfanne ohne Deckel  
Round dish without lid  
Paelheira sem tampa

Ref	€	Ø (cm)	U.Venta
50624S	48,30	24	1
50628S	68,40	28	1
50632S	87,80	32	1
50636S	112,50	36	1
50640S	130,20	40	1
50645S	152,30	45	1
50650S	200,10	50	1
*50660S	295,50	60	1

\* NO inducción · NOT induction



### Cazo recto

Casserole  
Stielkasserolle, flach  
Saucepan  
Caçarola direita



Ref	€	Ø (cm)	h (cm)	e (mm)	L	U.Venta
50212	27,40	12	7,0	0,7	0,75	1
50214	29,50	14	7,5	0,7	1,10	1
50216	32,40	16	8,0	0,8	1,60	1
50218	35,00	18	9,0	0,8	2,20	1
50220	38,70	20	9,0	0,8	2,80	1
50224	47,70	24	9,5	0,8	4,25	1
50228	66,90	28	11,0	0,8	6,75	1

### Cazo recto alto

Casserole haute  
Stielkasserolle, hoch  
Deep saucepan  
Caçarola alta direita



Ref	€	Ø (cm)	h (cm)	e (mm)	L	U.Venta
50217	34,60	16	11,0	0,8	2,10	1
50219	40,10	18	12,0	0,8	3,00	1
50221	45,20	20	13,0	0,8	4,00	1
50225	55,10	24	14,0	0,8	6,30	1
50229	74,90	28	17,5	0,8	10,20	1

### Cazo Francés

Casserole Française  
Stielkasserolle, französisch  
French saucepan  
Francês caçarola direita



Ref	€	Ø (cm)	h (cm)	e (mm)	L	U.Venta
50225N	52,90	24	12,0	0,8	5,50	1
50229N	68,50	28	14,0	0,8	8,50	1

### Baño maría con fondo

Bahut avec fond  
Bain Marie Topf  
Double boiler with bottom  
Banho-Maria com fundo



Ref	€	Ø (cm)	h (cm)	e (mm)	L	U.Venta
50717	39,80	16	16,0	0,8	3,20	1
50721	51,70	20	20,0	0,8	6,20	1

### Cazo cónico

Sautase conique  
Sauteuse, Konisch  
Conical saute pan  
Caçarola cónica



Ref	€	Ø (cm)	h (cm)	e (mm)	L	U.Venta
51216	39,30	16	6,0	1,0	1,00	1
51218	41,40	18	6,0	1,0	1,20	1
51220	43,20	20	6,5	1,0	1,60	1
51222	47,20	22	7,0	1,0	2,10	1
51224	51,70	24	7,5	1,0	2,70	1

### Sautex

Sauteuse  
Sauteuse  
Sauteuse  
Frigideira



Ref	€	Ø (cm)	h (cm)	e (mm)	L	U.Venta
50625	46,20	24	6,5	0,8	2,70	1
50629	63,80	28	7,0	0,8	4,00	1
50633	72,20	32	8,5	0,8	4,70	1
50637	104,10	36	10,0	1,0	7,00	1

### Rustidera

Plat à roir  
Bratpfanne  
Roaster  
Assadeira



Ref	€	cm	h (cm)	e (mm)	U.Venta
50540	115,20	40x30	8,0	1,0	1
50550	152,60	50x40	8,0	1,0	1
50560	192,20	60x45	8,0	1,0	1
50570	219,60	70x45	9,5	1,0	1

### Tapa

Couvercle  
Deckel  
Lid  
Tampa



Ref	€	Ø (cm)	U.Venta
50916	10,30	16	1
50918	11,50	18	1
50920	13,50	20	1
50924	14,80	24	1
50928	16,90	28	1
50932	22,40	32	1
50936	26,80	36	1
50940	30,40	40	1
50945	36,30	45	1
50950	44,60	50	1
50960	58,20	60	1

# Batería ECO-CHEF

Inox  
18/10



Sandwich



Vitro



Electric



Gas



Induction



Oven



Dishwasher



## Máxima garantía en resistencia y durabilidad

Maximum guarantee in resistance and durability

- Toda la pieza (cuerpo, asas y mangos) fabricada en acero inoxidable.
- Fondo termodifusor (inox 18/10 - aluminio - inox). Espesor 0,6 - 1 mm.
- Tapas diseñadas para el ahorro energético.
- Apta para todos los tipos de cocina (incluida inducción y horno).
- Acabado interior mate y exterior brillo-mate.
- Máxima garantía en cuanto a resistencia, durabilidad e higiene.

- Toute la pièce (corps, poignées et manches) est fabriquée en acier inoxydable.
- Fond thermo-diffuseur (Inox 18/10 - Aluminium - Inox). Épaisseur 0,6 - 1 mm.
- Couvercles conçus pour une économie d'énergie.
- Compatible avec tous les types de cuisinières (y compris induction et four).
- Finition mate intérieur et brillant-mate extérieur.
- Garantie maximale en termes de résistance, de durabilité et d'hygiène.

- Ganzes Stück (Topf, Griffe und Stiele) aus rostfreiem Stahl 18/10.
- Wärmeleitender Boden (Edelstahl 18/10 - Aluminium - Edelstahl). 0,6 - 1 mm dick.
- Energiesparende Deckel.
- Für alle Herdarten geeignet (inkl. Induktion und Ofen).
- Innen satiniert und außen Helligkeit und satiniert.
- Garantiert robust, langlebig und hygienisch.

- The whole product (body, handles and grips) is made in stainless steel.
- Heat diffuser bottom (18/10 stainless steel - Aluminium - Stainless). Thickness 0.6 - 1 mm.
- Covers designed for saving energy.
- Suitable for all types of cooking surfaces (including induction and the oven).
- Interior matte finish and exterior brightness-matte finish.
- Maximum guarantee in terms of resistance, durability and hygiene.

- Peça fabricada inteiramente (corpo, asas e mangos) em aço inoxidável.
- Fundo Termodifusor (Inox 18/10 - Alumínio - Inox). Espessura 0,6 - 1 mm.
- Tampas desenhadas para poupar energia.
- Apta para todos os tipos de fogões (incluindo placas de indução e forno).
- Acabamento interior mate e exterior brilho-mate.
- Máxima garantia de resistência, durabilidade e higiene.



## Cacerola sin tapa

Faitout sans couvercle  
Bratentopf ohne Deckel  
Casserole without lid  
Caçarola sem tampa

Ref	€	Ø (cm)	h (cm)	e (mm)	L	U.Venta
57016	30,30	16	8,0	0,6	1,60	1
57020	37,20	20	9,0	0,6	2,80	1
57024	40,80	24	9,5	0,7	4,25	1
57028	64,70	28	11,0	0,7	6,75	1
57032	77,10	32	12,5	0,7	10,00	1
57036	114,10	36	14,5	0,7	14,20	1
57040	129,90	40	15,5	0,9	19,40	1



## Cacerola alta sin tapa

Braisiere sans couvercle  
Fleischtopf ohne Deckel  
Deep casserole without lid  
Caçarola alta sem tampa

Ref	€	Ø (cm)	h (cm)	e (mm)	L	U.Venta
57017	32,30	16	11,0	0,6	2,20	1
57021	39,30	20	13,0	0,6	4,00	1
57025	48,10	24	15,0	0,7	7,00	1
57029	70,70	28	17,5	0,7	10,00	1
57033	85,50	32	18,0	0,7	14,40	1
57037	125,10	36	21,5	0,9	21,80	1
57041	153,50	40	24,5	0,9	30,70	1



### Olla recta sin tapa

Marmite traiteur sans couvercle  
Suppentopf ohne Deckel  
Stock pot without lid  
Panela sem tampa

Ref	€	Ø (cm)	h (cm)	e (mm)	L	U.Venta
57116	36,90	16	16,0	0,7	3,20	1
57120	43,20	20	20,0	0,7	6,20	1
57124	60,70	24	24,0	0,7	10,50	1
57128	89,60	28	25,5	0,9	16,50	1
57132	128,80	32	32,0	0,9	25,70	1
57136	161,70	36	36,0	0,9	36,60	1
57140	199,10	40	40,0	1,0	50,00	1



### Paellera sin tapa

Plat rond sans couvercle  
Pfanne ohne Deckel  
Round without lid  
Paelheira sem tampa

Ref	€	Ø (cm)	h (cm)	e (mm)	L	U.Venta
57624	40,10	24	6,5	0,7	3,00	1
57628	55,50	28	6,5	0,7	4,00	1
57632	70,90	32	7,0	0,7	5,00	1
57636	93,70	36	7,0	0,9	7,10	1
57640	108,00	40	8,0	0,9	10,00	1



### Cazo recto

Casserole  
Stielkasserolle, flach  
Saucepan  
Caçarola direita

Ref	€	Ø (cm)	h (cm)	e (mm)	L	U.Venta
57212	23,00	12	7,0	0,6	0,75	1
57214	24,60	14	7,5	0,6	1,10	1
57216	26,10	16	8,0	0,6	1,60	1
57218	28,70	18	8,5	0,6	2,00	1
57220	32,10	20	9,0	0,6	2,80	1
57224	41,40	24	9,5	0,7	4,25	1



### Cazo recto alto

Casserole haute  
Stielkasserolle, hoch  
Deep saucepan  
Caçarola alta direita

Ref	€	Ø (cm)	h (cm)	e (mm)	L	U.Venta
57217	28,70	16	11,0	0,6	2,10	1
57219	33,40	18	12,0	0,6	3,00	1
57221	37,90	20	13,0	0,6	4,00	1
57225	52,10	24	15,0	0,7	6,50	1



### Baño maría con fondo

Bahut avec fond  
Bain marie Topf  
Double boiler with bottom  
Banho-Maria com fundo

Ref	€	Ø (cm)	h (cm)	e (mm)	L	U.Venta
57717	33,70	16	16,0	0,7	3,20	1
57721	45,20	20	20,0	0,7	6,20	1



### Sautex

Sauteuse  
Sauteuse  
Sauteuse  
Frigideira

Ref	€	Ø (cm)	h (cm)	e (mm)	L	U.Venta
57625	37,90	24	6,5	0,7	2,70	1
57629	57,30	28	6,5	0,7	4,00	1



### Tapa

Couvercle  
Deckel  
Lid  
Tampa

Ref	€	Ø (cm)	U.Venta
57916	11,00	16	1
57920	13,90	20	1
57924	15,10	24	1
57928	17,40	28	1
57932	22,50	32	1
57936	27,70	36	1
57940	31,30	40	1

# Batería CHEF-ALUMINIO



**Aluminio puro (99,5%)**  
Made in pure aluminium (99,5%)

- Cuerpo fabricado en aluminio puro (99,5%).
- Asas y mangos atérmicos en tubo de acero inoxidable 18/10.
- Espesor 2,5 - 5 mm.
- Tapas diseñadas para el ahorro energético.
- Apta para todos los tipos de cocina (excepto inducción).
- Acabado mate interior y exterior mate lijado.
- Máxima garantía en cuanto a resistencia, durabilidad e higiene.

- Corps fabriqué en aluminium pur (99,5%).
- Poignées et manches athermiques en tube d'acier inoxydable 18/10.
- Épaisseur 2,5 - 5 mm.
- Couverts conçus pour une économie d'énergie.
- Compatible avec tous les types de cuisinières (excepté l'induction).
- Finition intérieur mate et extérieur mate polie.
- Garantie maximale en termes de résistance, de durabilité et d'hygiène.

- Körper aus reinem Aluminium (99,5%).
- Griffe und Stiele aus hitzeabweisendem Edelstahlrohr 18/10.
- 2,5 - 5 mm dick.
- Energiesparende Deckel.
- Für alle Herdarten geeignet (außer Induktion).
- Innen und außen matt glänzend.
- Garantiert robust, langlebig und hygienisch.

- Body made in pure (99.5%) aluminium.
- Heatproof handles and grips in a 18/10 stainless steel tube.
- Thickness 2.5 - 5 mm.
- Covers designed for saving energy.
- Suitable for all types of cooking surfaces (except induction).
- Interior matte finish and exterior sanded matte finish.
- Maximum guarantee in terms of resistance, durability and hygiene.

- Corpo fabricado em alumínio puro (99,5%).
- Asas e mangos térmicos em tubo de aço inoxidável 18/10.
- Espessura 2,5 - 5 mm.
- Tampas desenhadas para poupar energia.
- Apta para todos os tipos de fogões (exceto placas de indução).
- Acabamento mate interior e exterior mate lixado.
- Máxima garantia de resistência, durabilidade e higiene.



## Cacerola con tapa

Braisiere a/couvercle  
Bratentopf mit Deckel  
Casserole with lid  
Caçarola com tampa

Ref	€	Ø (cm)	h (cm)	e (mm)	L	U.Venta
20020	48,70	20	8,0	2,5	2,50	1
20024	54,30	24	9,5	2,5	4,30	1
20028	65,40	28	11,0	2,5	6,75	1
20030	70,30	30	11,5	2,5	8,15	1
20032	75,20	32	12,0	2,5	9,65	1
20034	81,70	34	13,0	3,0	11,80	1
20036	86,70	36	14,0	3,0	14,25	1
20038	97,20	38	15,0	3,0	17,00	1
20040	102,50	40	16,0	3,0	21,10	1
20045	122,40	45	18,0	3,5	28,00	1
20050	146,40	50	21,0	3,5	41,00	1
20060	208,50	60	25,0	4,5	70,00	1



## Cacerola alta c/ tapa

Braisiere avec couvercle  
Fleischtopf mit Deckel  
Deep casserole with lid  
Caçarola alta com tampa

Ref	€	Ø (cm)	h (cm)	e (mm)	L	U.Venta
20021	53,00	20	13,0	2,5	4,10	1
20025	60,80	24	15,0	2,5	6,80	1
20029	70,20	28	17,0	2,5	10,45	1
20031	76,60	30	18,0	2,5	12,70	1
20033	88,80	32	19,0	3,0	15,25	1
20035	95,70	34	21,0	3,0	18,05	1
20037	98,00	36	22,0	3,0	22,40	1
20039	106,30	38	23,0	3,0	26,10	1
20041	122,40	40	25,0	3,5	31,40	1
20046	139,90	45	28,0	4,5	45,00	1
20051	185,60	50	31,0	4,5	60,00	1
20061	246,20	60	37,0	4,5	104,00	1



### Olla recta con tapa

Marmite traiteur a/couvercle  
Suppentopf mit Deckel  
Stock pot with lid  
Panela com tampa

Ref	€	Ø (cm)	h (cm)	e (mm)	L	U.Venta
20120	60,30	20	20,0	2,5	6,30	1
20124	70,30	24	24,0	2,5	10,85	1
20128	88,40	28	28,0	3,0	17,25	1
20130	96,80	30	30,0	3,0	21,20	1
20132	106,50	32	32,0	3,0	25,75	1
20134	117,80	34	34,0	3,5	30,90	1
20136	126,70	36	36,0	3,5	36,65	1
20138	135,50	38	38,0	3,5	43,10	1
20140	151,90	40	40,0	4,0	50,30	1
20145	187,40	45	45,0	4,5	72,00	1
20150	211,10	50	50,0	4,5	100,00	1
20160	307,90	60	55,0	5,0	155,50	1



### Paellera

Plat rond  
Pfanne  
Round  
Paelheira

Ref	€	Ø (cm)	h (cm)	e (mm)	L	U.Venta
20628	41,80	28	7,0	2,5	4,30	1
20630	44,40	30	6,5	2,5	4,75	1
20632	47,50	32	7,0	2,5	5,50	1
20634	50,20	34	7,0	2,5	6,35	1
20636	53,10	36	7,5	2,5	7,45	1
20638	53,90	38	7,5	3,0	8,60	1
20640	63,40	40	8,0	3,0	10,05	1
20645	69,30	45	8,0	3,0	12,50	1
20650	80,80	50	8,0	3,0	15,50	1
20660	115,50	60	10,0	3,5	28,00	1



### Cazo recto

Casserole  
Stielkasserolle, flach  
Saucepan  
Çaçarola direite

Ref	€	Ø (cm)	h (cm)	e (mm)	L	U.Venta
20216	27,20	16	7,0	2,5	1,40	1
20220	32,50	20	8,0	2,5	2,50	1
20224	37,00	24	9,5	2,5	4,30	1
20228	43,90	28	11,0	2,5	6,80	1



### Cazo recto alto

Casserole haute  
Stielkasserolle, hoch  
Deep saucepan  
Çaçarola alta direite

Ref	€	Ø (cm)	h (cm)	e (mm)	L	U.Venta
20217	32,10	16	11,0	2,5	2,20	1
20221	37,30	20	13,0	2,5	4,10	1
20225	43,40	24	15,0	2,5	6,80	1
20229	50,20	28	17,0	2,5	10,50	1



### Cazo bombado

Casserole bombée  
Kasserolle, Bauchig  
Rounded saucepan  
Çaçarola bojuda

Ref	€	Ø (cm)	h (cm)	e (mm)	L	U.Venta
21216	27,40	16	8,0	2,5	1,50	1
21220	32,80	20	10,0	2,5	2,50	1
21224	38,80	24	12,0	2,5	4,00	1
21228	45,90	28	14,0	2,5	6,50	1



### Pote cilíndrico

Pot-cilindrique  
Milchtopf  
Cylindrical pot  
Caneca cilíndrica

Ref	€	Ø (cm)	h (cm)	e (mm)	L	U.Venta
20716	34,50	16	16,0	2,5	3,20	1
20720	40,50	20	20,0	2,5	6,30	1



### Rustidera con asas abatibles

Plat à rotir anse tombante  
Bratpfanne mit Fallgriffen  
Roaster moving handle  
Assadeira com asa abatível

Ref	€	cm	h (cm)	e (mm)	L	U.Venta
20540A	53,90	40x30	6,2	2,5	7,45	1
20545A	57,80	45x32	6,2	2,5	10,40	1
20550A	72,60	50x35	7,0	3,0	12,60	1
20555A	78,80	55x37	7,7	3,0	16,30	1
20560A	84,70	60x40	7,7	3,0	18,95	1
20565A	94,80	65x43	7,9	3,0	24,30	1
20570A	100,30	70x45	9,0	3,0	28,65	1



### Rustidera con asas fijas

Plat à rotir anse fixe  
Bratpfanne, m. festehenden Griffen  
Roaster fix handle  
Assadeira com asa fixa

Ref	€	cm	h (cm)	e (mm)	L	U.Venta
20540F	53,90	40x30	6,2	2,5	7,45	1
20545F	57,80	45x32	6,2	2,5	10,40	1
20550F	72,60	50x35	7,0	3,0	12,60	1
20555F	78,80	55x37	7,7	3,0	16,30	1
20560F	85,30	60x40	7,7	3,0	18,95	1
20565F	94,80	65x43	7,9	3,0	24,30	1
20570F	100,30	70x45	9,0	3,0	28,65	1



### Hervidor de pescado

Poissonnière avec grille  
Fischkessel mit Einsatz  
Fish kettle with grill and lid  
Peixeira

Ref	€	cm	h (cm)	e (mm)	L	U.Venta
20470	203,80	70x22	20,80	2,5	14,0	1



### Bandeja horno

Plaque à four  
Backblech  
Oven tray  
Bandeja forno

Ref	€	cm	h (cm)	e (mm)	U.Venta
20551	40,50	50x35	2,0	2,5	1
20561	49,40	60x40	2,0	2,5	1

### Tapa

Couvercle  
Deckel  
Lid  
Tampa



Ref	€	Ø (cm)	U.Venta
20920	14,50	20	1
20924	15,50	24	1
20928	18,80	28	1
20930	19,60	30	1
20932	21,70	32	1
20934	22,20	34	1
20936	23,80	36	1
20938	24,80	38	1
20940	27,60	40	1
20945	30,10	45	1
20950	35,80	50	1
20960	42,20	60	1



# Baterías domésticas

Household cookware



# Batería FOODIE

Inox  
18/10



Sandwich



Vitro



Electric



Gas



Induction



Oven



Dishwasher



- Fabricadas en acero inoxidable 18/10 de la mejor calidad.
- Asas y mangos ergonómicos de acero inoxidable fundido.
- Máxima garantía en cuanto a resistencia, durabilidad e higiene.
- Acabado interior y exterior lijado satinado.
- Marcaje de capacidades en el interior (litros).
- Fondo termodifusor sandwich (inox 18/10 - aluminio - inoxidable).
- Distribución rápida y uniforme del calor.
- Aptas para todos los fuegos (incluido inducción y horno).

- Fabriquées en acier inoxydable 18/10 de la meilleure qualité.
- Poignées et manches ergonomiques en acier inoxydable fondu.
- Garantie maximale en termes de résistance, de durabilité et d'hygiène.
- Finition intérieure et extérieure en polissage satiné.
- Marquage des contenances à l'intérieur (litres).
- Fond thermodiffuseur sandwich (inox 18/10 - aluminium - inoxydable).
- Distribution rapide et uniforme de la chaleur.
- Aptes pour tous les types de feux (y compris l'induction et le four).

- Aus Edelstahl 18/10 bester Qualität.
- Ergonomische Griffe und Stiele aus gegossenem Edelstahl.
- Garantiert robust, langlebig und hygienisch.
- Außen- und Innenseite in mattem Schliff.
- Füllstandsanzeige (in Liter) auf der Innenseite.
- Wärmeleitender Sandwichboden (Edelstahl 18/10 - Aluminium - Edelstahl).
- Gleichmäßige und schnelle Wärmeverteilung.
- Für alle Herdarten geeignet (inkl. Induktion und Ofen).

- Maximum guarantee in resistance, durability and hygiene.
- Ergonomic handles and grips made of cast stainless steel.
- Maximum guarantee in terms of resistance, durability and hygiene.
- Glossy sanded interior and exterior finish.
- Capacity markings on the inside (litres).
- Heat-diffusing sandwiched base (18/10 stainless steel - aluminium - st. Steel).
- Quick and even heat distribution.
- Suitable for all types of cookers (including induction hobs and ovens).

- Fabricadas em aço inoxidável 18/10 da melhor qualidade.
- Asas e cabos ergonómicos em aço inoxidável fundido.
- Máxima garantia de resistência, durabilidade e higiene.
- Acabamento interior e exterior lixado acetinado.
- Indicação de capacidades no interior (em litros).
- Fundo termodifusor tipo sanduíche (inox 18/10 - alumínio - inoxidável).
- Distribuição rápida e uniforme do calor.
- Apta para todo o tipo de fogões (incluindo placas de indução e fornos).

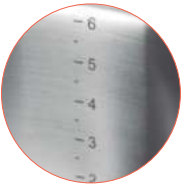

## Marcaje de capacidades en el interior (litros)

Capacity markings on the inside (litres)

## Cacerola con tapa

Faitout avec couvercle  
Bratentopf mit Deckel  
Casserole with lid  
Caçarola com tampa



Ref	€	Ø (cm)	h (cm)	L	U.Venta
45016	45,70	16	7,5	1,50	1
45018	49,60	18	8,5	2,00	1
45020	54,20	20	9,5	3,00	1
45022	61,60	22	10,5	4,00	1
45024	67,90	24	11,5	5,00	1
45026	75,10	26	12,5	6,50	1
45028	81,20	28	12,5	7,50	1

## Olla con tapa

Marmite avec couvercle  
Fleichtopf mit Deckel  
Stock pot with lid  
Panela com tampa



Ref	€	Ø (cm)	h (cm)	L	U.Venta
45116	50,30	16	13,0	2,50	1
45118	53,80	18	14,0	3,50	1
45120	60,80	20	15,5	4,80	1
45122	66,20	22	15,5	5,50	1
45124	73,70	24	16,0	7,00	1
45126	80,60	26	16,0	8,00	1
45128	91,50	28	17,0	10,00	1

### Cazo recto

Casserole  
Stielkasserolle, flach  
Saucepan  
Çaçarola direita



Ref	€	Ø (cm)	h (cm)	L	U.Venta
45214	32,80	14	7,5	1,00	1
45216	35,30	16	7,5	1,50	1
45218	39,40	18	8,5	2,00	1
45220	44,70	20	9,5	3,00	1

### Tartera con tapa

Plat rond avec couvercle  
Pfanne mit Deckel  
Round dish with lid  
Tarteira com tampa



Ref	€	Ø (cm)	h (cm)	L	U.Venta
45624	62,50	24	6,5	2,80	1
45626	68,60	26	6,5	3,00	1
45628	74,20	28	6,5	4,00	1

### Tapa

Couvercle  
Deckel  
Lid  
Tampa



Ref	€	Ø (cm)	U.Venta
45916	12,30	16	1
45918	12,90	18	1
45920	13,90	20	1
45922	15,00	22	1
45924	16,50	24	1
45926	17,60	26	1
45928	19,50	28	1

### Sartén

Poêle  
Pfanne  
Frying pan  
Sertã



Ref	€	ØD (cm)	Ød (cm)	h (cm)	e (mm)	U.Venta
45420	31,20	20	13,5	5,5	0,6	1
45424	37,20	24	17,5	6,0	0,6	1
45428	43,70	28	19,5	6,5	0,6	1



#### · Antiadherente QuanTanium® reforzado con partículas de titanio; libre de materiales tóxicos y pesados, ecológico y libre de PFOA.

- Antiadhésif QuanTanium® renforcé avec des particules de titane ; sans matériaux toxiques ni métaux lourds, écologique et sans PFOA.
- Antihafbeschichtung QuanTanium® mit Titanbeimischung, frei von Giftstoffen und Schwermetallen, umweltfreundlich und ohne PFOA.
- QuanTanium® non-stick reinforced with titanium particles; free from toxic and heavy materials, environmentally friendly and PFOA-free.
- Material antiaderente QuanTanium® reforçado com partículas de titânio, ecológico e livre de PFOA. Não contém materiais tóxicos e pesados.



### Sartén antiadherente

Poêle antiadherent  
Pfanne, Antihaf  
Frying-pan, non-stick  
Sertã anti-aderente

Ref	€	ØD (cm)	Ød (cm)	h (cm)	e (mm)	U.Venta
45320	36,60	20	13,5	5,5	0,6	1
45324	44,80	24	17,5	6,0	0,6	1
45328	53,70	28	19,5	6,5	0,6	1

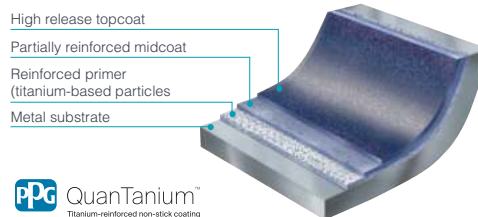

PPG QuanTanium™  
Titanium-reinforced non-stick coating

# Batería PROFESIONAL

Inox  
18/10



Sandwich



Vitro



Electric



Gas



Induction



Oven



Dishwasher



- Toda la pieza (cuerpo, asas y mangos) fabricada en acero Inoxidable 18/10.
- Favorece una distribución rápida y homogénea del calor.
- Acabado pulido brillante exterior y lijado mate interior.
- Máxima garantía en cuanto a resistencia, durabilidad e higiene.
- Apta para todo tipo de cocinas (incluido inducción y horno).
- Fondo termodifusor sándwich (inox 18/10 - aluminio - inox).

- Toute la pièce (corps, poignées et manches) est fabriquée en acier inoxydable 18/10.
- Favorise une distribution rapide et homogène de la chaleur.
- Finition extérieur polie brillante et intérieur polie mate.
- Garantie maximale en termes de résistance, de durabilité et d'hygiène.
- Compatible avec tout type de cuisinières (y compris induction et four).
- Fond thermo-diffuseur sandwich (inox 18/10 - aluminium - inox).

- Ganzes Stück (Topf, Griffe und Stiele) aus rostfreiem Stahl 18/10.
- Fördert eine gleichmäßige und schnelle Wärmeverteilung.
- Hochglanzpolierte Außen- und glänzend matte Innenseite.
- Garantiert robust, langlebig und hygienisch.
- Für alle Herdarten geeignet (inkl. Induktion und Ofen).
- Wärmeleitender Sandwichboden (Edelstahl 18/10 - Aluminium - Edelstahl).

- The whole product (body, handles and grips) is made in 18/10 stainless steel.
- It favours quick and homogeneous heat distribution.
- Exterior glossy, polished finish and sanded matte interior.
- Maximum guarantee in terms of resistance, durability and hygiene.
- Suitable for all types of cooking surfaces (including induction and the oven).
- Sandwich heat diffuser (18/10 stainless steel - aluminium - stainless steel).

- Peça fabricada inteiramente (corpo, asas e mangos) em aço inoxidável 18/10.
- Favorece a distribuição rápida e homogénea do calor.
- Acabamento exterior brilhante polido, e interior mate lixado.
- Máxima garantia de resistência, durabilidade e higiene.
- Apta para todo o tipo de fogões (incluindo placas de indução e forno).
- Fundo termodifusor tipo sanduiche (inox 18/10 - alumínio - inox).

## Cacerola con tapa

Faitout a/couvercle  
Bratentopf mit Deckel  
Casserole with lid  
Caçarola com tampa



Ref	€	Ø (cm)	h (cm)	L	U.Venta
72016	51,30	16	8,0	1,50	1
72020	59,90	20	8,5	2,50	1
72024	70,10	24	9,5	3,50	1
72028	89,80	28	11,0	6,50	1
72032	121,80	32	12,5	9,00	1

## Olla con tapa

Marmite a/couvercle  
Fleischtopf mit Deckel  
Stock pot with Lid  
Panela com tampa



Ref	€	Ø (cm)	h (cm)	L	U.Venta
72116	55,40	16	13,0	2,50	1
72120	64,00	20	14,5	4,50	1
72124	77,00	24	15,0	6,50	1
72128	100,10	28	17,0	10,00	1
72132	127,90	32	17,5	13,50	1

## Olla super alta con tapa

Marmite S. Haute a/couvercle  
Hoher Fleischtopf mit Deckel  
Deep Stock pot with Lid  
Panela super alta com tampa



Ref	€	Ø (cm)	h (cm)	L	U.Venta
72125	84,10	24	20,0	9,00	1
72129	110,10	28	22,0	13,50	1

## Cazo recto

Casserole  
Stielkasserole, flach  
Saucepan  
Caçarola direite



Ref	€	Ø (cm)	h (cm)	L	U.Venta
72214	27,50	14	7,5	1,00	1
72216	31,10	16	8,0	1,50	1
72218	33,40	18	8,5	2,00	1
72220	37,60	20	8,5	2,50	1

### Colador esférico

Passoire à queue  
Seiher, mit Stiel  
Strainer  
Coador esférico



Ref	€	Ø (cm)	h (cm)	U.Venta
72318	32,90	18	8,5	1

### Escurridera

Passoire sur pied  
Abtropfschüssel  
Colander with stand  
Escorredor



Ref	€	Ø (cm)	h (cm)	U.Venta
72324	50,50	24	11,0	1

### Cacerola vapor

Panier vapeur  
Dampfkoch-Aufsatz  
Steam casserole  
Çaçarola a vapor



Ref	€	Ø (cm)	h (cm)	L	U.Venta
72420	42,50	20	8,5	2,50	1
72424	51,70	24	9,5	3,50	1
72428	57,60	28	11,0	6,50	1

### Cuecepastas sin tapa

Cuit-pâte sans couvercle  
Nudelkoch-Einsatz ohne Deckel  
Pasta cooker without lid  
Coze-massas sem tampa



Ref	€	Ø (cm)	h (cm)	L	U.Venta
72423	71,70	24	17,5	9,50	1

### Tartera con tapa

Plat rond avec couvercle  
Pfanne mit Deckel  
Round dish with lid  
Tarteira com tampa



Ref	€	Ø (cm)	h (cm)	L	U.Venta
72620	57,60	20	6,5	2,00	1
72624	67,90	24	7,0	3,00	1
72628	86,00	28	8,0	4,50	1
72632	113,50	32	8,0	6,00	1

### Sautex

Sauteuse  
Sauteuse  
Sauteuse  
Frigideira



Ref	€	Ø (cm)	h (cm)	L	U.Venta
72625	50,40	24	7,0	3,00	1
72629	63,00	28	8,0	4,50	1

### Pote cilíndrico

Pot-cilindrique  
Milchtopf  
Cylindrical pot  
Caneca cilíndrica



Ref	€	Ø (cm)	h (cm)	L	U.Venta
72714	32,30	14	12,5	1,50	1
72716	36,50	16	13,0	2,50	1
72720	41,30	20	14,5	4,50	1

### Tapa

Couvercle  
Deckel  
Lid  
Tampa



Ref	€	Ø (cm)	U.Venta
72916	13,90	16	1
72918	14,60	18	1
72920	16,90	20	1
72924	19,50	24	1
72928	25,20	28	1
72932	27,30	32	1

# Batería BELLY

Inox  
18/10



Sandwich



Vitro



Electric



Gas



Induction



Oven



Dishwasher



- Toda la pieza (cuerpo y asas) fabricada en acero inoxidable 18/10.
- Máxima garantía en cuanto a resistencia, durabilidad e higiene.
- El diseño de cuerpos bombeados proporciona mayor capacidad.
- Marcaje de capacidades en el interior (litros).
- Fondo termodifusor sandwich (inox 18/10 - aluminio - inoxidable).
- Distribución rápida y uniforme del calor.
- Apta para todos los fuegos (incluido inducción y horno).
- Incluye tapa de cristal resistente a los golpes con válvula y borde de acero inoxidable 18/10.

- Toute la pièce (corp et poignées) est fabriquée en acier inoxydable 18/10.
- Garantie max. en termes de résistance, de durabilité et d'hygiène.
- La forme bombée des corps confère une plus grande capacité.
- Marquage des contenances à l'intérieur (litres).
- Fond thermodiffuseur sandwich (inox 18/10 - aluminium - inoxydable).
- Distribution rapide et uniforme de la chaleur.
- Apte pour tous les types de feux (y compris l'induction et le four).
- Inclut un couvercle en verre avec soupape résistante aux chocs et bord en acier inoxydable 18/10.

- Ganzes Stück (Topf und Griffes) aus rostfreiem Stahl 18/10.
- Garantiert robust, langlebig und hygienisch.
- Konvex geformter Körper mit höherem Fassungsvermögen.
- Füllstandsanzeige (in Liter) auf der Innenseite.
- Wärmeleitender Sandwichboden (Edelstahl 18/10 - Aluminium - Edelstahl).
- Gleichmäßige.
- Für alle Herdarten geeignet (inkl. Induktion und Ofen). Waschmaschinen tauglich.
- Deckel aus Glas mit stoßfestem Ventil un rand aus nicht rostendem 18/10-Stahl.

- The whole product (body and handles) is made in 18/10 st. steel.
- Max. guarantee in terms of resistance, durability and hygiene.
- Its rounded body provides greater capacity.
- Capacity markings on the inside (litres).
- Heat-diffusing sandwiched base (18/10 stainless Steel - aluminium - stainless Steel).
- Quick and even heat distribution.
- Suitable for all types of cookers (including induction hobs and ovens).
- It includes a glass cover with pressure valve resistant to bumps and 18/10 stainless steel rim.

- Peça fabricada integralmente (corpo e asas) em aço inoxidável 18/10.
- Máx.garantia de resistência, durabilidade e higiene.
- O design côncavo proporciona maior capacidade.
- Indicação de capacidades no interior (em litros).
- Fundo termodifusor tipo sanduíche (inox 18/10 - alumínio - inoxidável).
- Distribuição rápida e uniforme do calor.
- Apta para todo o tipo de fogões (incluindo placas de indução e fornos).
- Tampa de voidro com válvula, resistente aos golpes e rebordo em aço inoxidável 18/10.

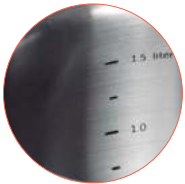

## Marcaje de capacidades en el interior (litros)

Capacity markings on the inside (litres)

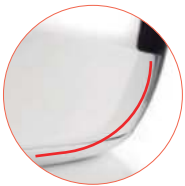

## Fondo curvo

Curved bottom

## Cacerola con tapa

Faitout avec couvercle  
Bratentopf mit Deckel  
Casserole with lid  
Caçarola com tampa



Ref	€	Ø (cm)	h (cm)	L	U.Venta
79016	44,40	16	8,5	1,20	1
79020	60,30	20	9,5	2,50	1
79024	82,20	24	11,5	4,40	1
79028	108,00	28	15,0	8,20	1

## Olla con tapa

Marmite avec couvercle  
Fleischtopf mit Deckel  
Stock pot with Lid  
Panela com tampa



Ref	€	Ø (cm)	h (cm)	L	U.Venta
79116	49,70	16	10,0	1,60	1
79120	68,20	20	12,0	3,50	1
79124	87,50	24	14,0	5,50	1
79128	115,90	28	17,0	9,50	1

### Cazo recto

Casserole  
Stielkasserole, flach  
Saucepan  
Caçarola direita



Ref	€	Ø (cm)	h (cm)	L	U.Venta
79214	31,10	14	9,0	1,20	1
79216	36,30	16	9,5	1,60	1
79218	41,20	18	10,5	2,50	1
79220	47,60	20	11,5	3,50	1

### Cacerola vapor

Panier vapeur  
Dampfkoch-Aufsatz  
Steam casserole  
Caçarola a vapor



Ref	€	Ø (cm)	h (cm)	L	U.Venta
79420	38,70	20	9,5	3,00	1
79424	51,60	24	12,0	4,50	1

### Tartera con tapa

Plat rond avec couvercle  
Pfanne mit Deckel  
Round dish with lid  
Tarteira com tampa



Ref	€	Ø (cm)	h (cm)	L	U.Venta
79624	68,50	24	7,5	2,60	1
79628	87,00	28	7,5	3,0	1

### Pote

Pot  
Milchtopf  
Pot  
Caneca



Ref	€	Ø (cm)	h (cm)	L	U.Venta
79714	31,10	14	11,0	1,50	1

### Wok

Wok  
Wok  
Wok  
Wok



Ref	€	Ø (cm)	h (cm)	L	U.Venta
79830	69,80	30	10,0	4,50	4

### Tapa

Couvercle  
Deckel  
Lid  
Tampa



Ref	€	Ø (cm)	U.Venta
79916	14,20	16	1
79920	19,00	20	1
79924	23,50	24	1
79928	29,70	28	1

# Batería VITROCOR

Inox  
18/10



Sandwich



Vitro



Electric



Gas



Induction



Oven



Dishwasher



- Toda la pieza (cuerpo, asas y mangos) fabricada en acero inoxidable 18/10.
- Favorece una distribución rápida y homogénea del calor.
- Destaca por su diseño clásico, funcionalidad y sencillez.
- Acabado pulido brillante exterior y lijado mate interior.
- Apta para todo tipo de cocinas (incluido inducción y horno).
- Fondo termodifusor sándwich (inox 18/10 - aluminio - inox).
- Apta para el lavavajillas.

- Toute la pièce (corps, poignées et manches) est fabriquée en acier inoxydable 18/10.
- Favorise une distribution rapide et homogène de la chaleur.
- Se distingue par son style classique, sa fonctionnalité et sa simplicité.
- Finition extérieur polie brillante et intérieur limage mat.
- Compatible avec tout type de cuisinières (y compris induction et four).
- Fond thermo-diffuseur sandwich (inox 18/10 - aluminium - inox).
- Apte pour le lave-vaisselle.

- Ganzes Stück (Topf, Griffe und Stiele) aus rostfreiem Stahl 18/10.
- Fördert gleichmäßige und schnelle Wärmeverteilung.
- Punktet mit klassischem Design, Funktionalität und einfacher Handhabung.
- Hochglanzpolierte Außen- und glänzend matte Innenseite.
- Für alle Herdarten geeignet (inkl. Induktion und Ofen).
- Wärmeleitender Sandwichboden (Edelstahl 18/10 - Aluminium - Edelstahl).
- Waschmaschinen tauglich.

- The whole product (body, handles and grips) is made in 18/10 stainless steel.
- It favours quick and homogeneous heat distribution.
- Stands out for its classic design, functionality and simplicity.
- Exterior glossy, polished finish and sanded matte interior.
- Suitable for all types of cooking surfaces (including induction and the oven).
- Sandwich heat diffuser (18/10 stainless steel - aluminium - stainless steel).
- Dishwasher safe.

- Peça fabricada integralmente (corpo, asas e mangos) em aço inoxidável 18/10.
- Favorece a distribuição rápida e homogénea do calor.
- Design clássico, simples e funcional.
- Acabamento exterior polido brilhante, e mate lixado no interior.
- Apta para todo o tipo de fogões (incluindo placas de indução e forno).
- Fundo termodifusor tipo sanduíche (inox 18/10 - alumínio - inox).
- Apta para máquinas de lavar louça.

## Cacerola con tapa

Faitout avec couvercle  
Bratentopf mit Deckel  
Casserole with lid  
Çaçarola com tampa



Ref	€	Ø (cm)	h (cm)	L	U.Venta
40016	39,20	16	8,0	1,50	1
40018	42,70	18	8,5	2,00	1
40020	47,20	20	8,5	2,50	1
40022	51,80	22	9,0	3,00	1
40024	55,40	24	9,5	3,50	1
40026	62,80	26	9,5	4,50	1
40028	80,40	28	11,0	6,50	1
40032	101,30	32	12,5	9,50	1
40036	137,80	36	14,0	14,20	1
40040	159,90	40	15,5	19,50	1

## Olla con tapa

Marmite avec couvercle  
Fleischtopf mit Deckel  
Stock pot with Lid  
Panela com tampa



Ref	€	Ø (cm)	h (cm)	L	U.Venta
40116	44,10	16	13,0	2,50	1
40118	47,10	18	14,0	3,50	1
40120	51,40	20	14,5	4,50	1
40122	57,00	22	14,5	5,50	1
40124	64,00	24	15,0	6,50	1
40126	69,60	26	15,0	7,50	1
40128	88,00	28	17,0	10,00	1
40132	106,30	32	17,5	13,50	1
40136	150,70	36	21,5	22,00	1
40140	183,70	40	24,5	30,80	1

## Olla super alta con tapa

Marmite S. Haute a/couvercle  
Hoher Fleischtopf mit Deckel  
Deep Stock pot with Lid  
Panela super alta com tampa



Ref	€	Ø (cm)	h (cm)	L	U.Venta
40121	56,20	20	17,5	5,50	1
40125	73,10	24	20,0	9,00	1
40129	98,00	28	22,0	13,50	1
40133	145,10	32	28,0	22,50	1

## Cazo recto

Casserole  
Stielcasserole, flach  
Saucepan  
Çaçarola direita



Ref	€	Ø (cm)	h (cm)	L	U.Venta
40212	24,60	12	7,0	0,80	1
40214	25,50	14	7,5	1,00	1
40216	28,90	16	8,0	1,50	1
40218	31,50	18	8,5	2,00	1
40220	36,60	20	8,5	2,50	1

## Cacerola vapor

Panier vapeur  
Dampfkoch-Aufsatz  
Steam casserole  
Çaçarola a vapor



Ref	€	Ø (cm)	h (cm)	L	U.Venta
40420	35,00	20	8,5	2,50	1
40424	44,10	24	9,5	3,50	1
40428	48,40	28	11,0	6,50	1

## Cuecepastas sin tapa

Cuit-pâte sans couvercle  
Nudelkoch-Einsatz ohne Deckel  
Pasta cooker without lid  
Coze-massas sem tampa



Ref	€	Ø (cm)	h (cm)	L	U.Venta
40426	66,50	24	17,5	9,50	1

## Escurridera

Passoire sur pied  
Abtropfschüssel  
Colander with stand  
Escorredor



Ref	€	Ø (cm)	h (cm)	U.Venta
40324	48,90	24	11,0	1

## Colador esférico

Passoire à queue  
Seiher, mit Stiel  
Strainer  
Coador esférico



Ref	€	Ø (cm)	h (cm)	U.Venta
40318	31,30	18	8,5	1

## Tapa

Couvercle  
Deckel  
Lid  
Tampa

Ref	€	Ø (cm)	U.Venta
40916	10,60	16	1
40918	10,80	18	1
40920	11,40	20	1
40922	12,10	22	1
40924	13,30	24	1
40926	14,20	26	1
40928	17,90	28	1
40932	22,40	32	1
40936	30,00	36	1
40940	34,10	40	1



## Tartera con tapa

Plat rond avec couvercle  
Pfanne mit Deckel  
Round dish with lid  
Tarteira com tampa



Ref	€	Ø (cm)	h (cm)	L	U.Venta
40620	47,10	20	6,5	2,00	1
40622	50,10	22	6,5	2,50	1
40624	55,20	24	7,0	3,00	1
40626	59,80	26	7,0	3,50	1
40628	74,60	28	8,0	4,50	1
40632	90,50	32	8,0	6,00	1
40636	120,00	36	8,5	7,50	1
40640	138,70	40	8,5	11,00	1

## Pote cilíndrico

Pot-cilindrique  
Milchtopf  
Cylindrical pot  
Caneca cilíndrica



Ref	€	Ø (cm)	h (cm)	L	U.Venta
40712	29,00	12	12,0	1,00	1
40714	31,00	14	12,5	1,50	1
40716	34,10	16	13,0	2,50	1
40718	37,70	18	14,0	3,50	1

## Sartén

Poêle  
Pfanne  
Frying pan  
Sertã



Ref	€	Ø (cm)	h (cm)	e (mm)	U.Venta
40619	32,90	18	4,5	0,7	1
40621	35,00	20	4,5	0,7	1
40623	36,30	22	5,0	0,7	1
40625	38,80	24	5,2	0,7	1
40627	40,00	26	6,0	0,7	1
40629	42,90	28	6,5	0,7	1



# Batería GOURMET

Inox  
18/10



Sandwich



Vitro



Electric



Gas



Induction



Oven



Dishwasher



- Toda la pieza (cuerpo, asas y mangos) fabricada en acero inoxidable 18/10.
- Favorece una distribución rápida y homogénea del calor.
- Extremadamente robustos.
- Acabado pulido brillante exterior y lijado mate interior.
- Apta para todo tipo de cocinas (incluido inducción y horno).
- Triple fondo difusor que asegura un eficiente reparto del calor.

- Toute la pièce (corps, poignées et manches) est fabriquée en acier inoxydable 18/10.
- Favorise une distribution rapide et homogène de la chaleur.
- Extrêmement robustes.
- Finition extérieure polie brillante et intérieure limage mat.
- Compatible avec tout type de cuisinières (y compris induction et four).
- Triple fond diffuseur qui garantit une répartition efficace de la chaleur.

- Ganzes Stück (Topf, Griffe und Stiele) aus rostfreiem Stahl 18/10.
- Fördert gleichmäßige und schnelle Wärmeverteilung.
- Sehr robust.
- Hochglanzpolierte Außen- und glänzend matte Innenseite.
- Für alle Herdarten geeignet (inkl. Induktion und Ofen).
- Dreifachboden gewährleistet leistungsstarke Wärmeleitung.

- The whole product (body, handles and grips) is made in 18/10 stainless steel.
- It favours quick and homogeneous heat distribution.
- Extremely robust.
- Exterior glossy, polished finish and sanded matte interior.
- Suitable for all types of cooking surfaces (including induction and the oven).
- Triple diffuser bottom assuring efficient distribution of heat.

- Peça fabricada integralmente (corpo, asas e mangos) em aço inoxidável 18/10.
- Favorece a distribuição rápida e homogénea do calor.
- Extremamente robustas.
- Acabamento exterior polido brilhante, e mate lixado no interior.
- Aptas para todo o tipo de fogões (incluindo placas de indução e forno).
- Fundo difusor triplo, para uma distribuição eficiente do calor.

## Cacerola con tapa

Faitout avec couvercle  
Bratentopf mit Deckel  
Casserole with lid  
Caçarola com tampa



Ref	€	Ø (cm)	h (cm)	L	U.Venta
90016	43,60	16	8,0	1,50	1
90018	46,70	18	8,5	2,00	1
90020	51,30	20	8,5	2,50	1
90022	55,60	22	9,0	3,00	1
90024	60,10	24	9,5	3,50	1
90026	67,40	26	9,5	4,50	1
90028	82,70	28	11,0	6,50	1
90032	102,80	32	12,5	9,50	1

## Olla con tapa

Marmite avec couvercle  
Fleischtopf mit Deckel  
Stock pot with Lid  
Panela com tampa



Ref	€	Ø (cm)	h (cm)	L	U.Venta
90116	47,80	16	13,0	2,50	1
90118	51,70	18	14,0	3,50	1
90120	54,80	20	14,5	4,50	1
90122	61,00	22	14,5	5,50	1
90124	67,60	24	15,0	6,50	1
90126	72,90	26	15,0	7,50	1
90128	90,60	28	17,0	10,00	1
90132	117,40	32	17,5	13,50	1

## Olla super alta con tapa

Marmite S. Haute a/couvercle  
Hoher Fleischtopf mit Deckel  
Deep Stock pot with Lid  
Panela super alta com tampa



Ref	€	Ø (cm)	h (cm)	L	U.Venta
90125	77,60	24	20,0	9,00	1
90129	100,70	28	22,0	13,50	1

## Cazo recto

Casserole  
Stielkasserole, flach  
Saucepan  
Caçarola direita



Ref	€	Ø (cm)	h (cm)	L	U.Venta
90212	26,60	12	7,0	0,80	1
90214	28,10	14	7,5	1,00	1
90216	31,50	16	8,0	1,50	1
90218	34,10	18	8,5	2,00	1
90220	38,20	20	8,5	2,50	1

### Cacerola vapor

Panier vapeur  
Dampfkoch-Aufsatz  
Steam casserole  
Caçarola a vapor



Ref	€	Ø (cm)	h (cm)	L	U.Venta
90420	39,70	20	8,5	2,50	1
90424	48,80	24	9,5	3,50	1

### Tartera con tapa

Plat rond a/couvercle  
Pfanne mit Deckel  
Round dish with lid  
Tarteira com tampa



Ref	€	Ø (cm)	h (cm)	L	U.Venta
90620	51,30	20	6,5	2,00	1
90622	54,90	22	6,5	2,50	1
90624	58,70	24	7,0	3,00	1
90626	63,60	26	7,0	3,50	1
90628	75,70	28	8,0	4,50	1
90632	94,20	32	8,0	6,00	1

### Escurridera

Passoire sur pied  
Abtropfschüssel  
Colander with stand  
Escorredor



Ref	€	Ø (cm)	h (cm)	U.Venta
90324	47,40	24	11,0	1

### Colador esférico

Passoire à queue  
Seiher, mit Stiel  
Strainer  
Coador esférico



Ref	€	Ø (cm)	h (cm)	U.Venta
90318	31,30	18	8,5	1

### Pote cilíndrico

Pot-cilindrique  
Milchtopf  
Cylindrical pot  
Caneca cilíndrica



Ref	€	Ø (cm)	h (cm)	L	U.Venta
90712	29,60	12	12,0	1,00	1
90714	31,30	14	12,5	1,50	1
90716	35,20	16	13,0	2,50	1
90718	38,10	18	14,0	3,50	1

### Tapa

Couvercle  
Deckel  
Lid  
Tampa



Ref	€	Ø (cm)	U.Venta
90916	11,70	16	1
90918	11,70	18	1
90920	11,80	20	1
90922	12,00	22	1
90924	13,20	24	1
90926	14,20	26	1
90928	18,60	28	1
90932	24,00	32	1

# Batería BASIC



- Toda la pieza (cuerpo, asas y mangos) fabricada en acero inoxidable.
- La tapa, con cierre de precisión, preserva los aromas y retiene el calor.
- Ideal para cocinar de forma saludable y ahorrar energía.
- Acabado interior lijado satinado y exterior pulido brillante.
- Apta para todo tipo de cocinas (incluido inducción y horno).
- Apta para el lavavajillas.

- Toute la pièce (corps, poignées et manches) est fabriquée en acier inoxydable.
- Le couvercle, avec fermeture de précision, préserve les arômes et retient la chaleur.
- Idéal pour cuisiner sainement et réaliser des économies d'énergie.
- Finition intérieur limée satinée et extérieur polie brillante.
- Compatible avec tout type de cuisinières (y compris induction et four).
- Apte pour le lave-vaisselle.

- Ganzes Stück (Topf, Griffe und Stiele) aus rostfreiem Stahl.
- Deckel mit Druckverschluss bewahrt Geschmack und Wärme.
- Ideal für gesundheitsbewusste und energiesparende Küche.
- Außenseit mit mattem Schliff und Innenseite hochglanzpoliert.
- Für alle Herdarten geeignet (inkl. Induktion und Ofen).
- Waschmaschinen tauglich.

- The whole product (body, handles and grips) is made in stainless steel .
- The cover, with precision fit, retains the aromas and heat.
- Ideal for cooking healthy while saving energy.
- A sanded, satin interior finish and shiny, polished exterior.
- Suitable for all types of cooking surfaces (including induction and the oven).
- Dishwasher safe.

- Peça fabricada integralmente (corpo, asas e mangos) em aço inoxidável.
- Tampa com fecho de precisão, para preservar melhor os aromas e conservar o calor.
- Ideal para cozinhar de forma saudável e poupar energia.
- Acabamento interior acetinado lixado, e brilhante polido no exterior.
- Apta para todo o tipo de fogões (incluindo placas de indução e forno).
- Apta para máquinas de lavar louça.

## Cacerola con tapa

Faitout a/couvercle  
Bratentopf mit Deckel  
Casserole with lid  
Caçarola com tampa



Ref	€	Ø (cm)	h (cm)	L	U.Venta
32016	32,40	16	8,0	1,50	1
32020	39,40	20	8,5	2,50	1
32024	48,90	24	9,5	3,50	1
32028	63,20	28	11,0	6,50	1

## Olla con tapa

Marmite avec couvercle  
Fleischtopf mit Deckel  
Stock pot with Lid  
Panela com tampa



Ref	€	Ø (cm)	h (cm)	L	U.Venta
32116	39,40	16	13,0	2,50	1
32120	43,70	20	13,5	4,50	1
32124	55,30	24	15,0	6,50	1
32128	71,90	28	17,0	10,00	1

## Olla super alta con tapa

Marmite S. Haute a/couvercle  
Hoher Fleischtopf mit Deckel  
Deep Stock pot with Lid  
Panela super alta com tampa



Ref	€	Ø (cm)	h (cm)	L	U.Venta
32125	67,80	24	20,0	9,00	1
32129	85,60	28	22,5	13,50	1

## Cazo recto

Casserole  
Stielkasserole, flach  
Saucepan  
Caçarola direita



Ref	€	Ø (cm)	h (cm)	L	U.Venta
32214	19,20	14	7,5	1,00	1
32216	22,20	16	8,0	1,50	1
32218	24,60	18	8,5	2,00	1
32220	28,00	20	8,5	2,50	1

### Cacerola vapor

Panier vapeur  
Dampfkoch-Aufsatz  
Steam casserole  
Çaçarola a vapor



Ref	€	Ø (cm)	h (cm)	L	U.Venta
32420	25,10	20	8,5	2,50	1
32424	29,40	24	9,5	3,50	1

### Tartera con tapa

Plat rond avec couvercle  
Pfanne mit Deckel  
Round dish with lid  
Tarteira com tampa



Ref	€	Ø (cm)	h (cm)	L	U.Venta
32624	41,00	24	7,0	3,00	1
32628	57,50	28	8,0	4,50	1

### Escurridera

Passoire sur pied  
Abtropfschüssel  
Colander with stand  
Escorredor



Ref	€	Ø (cm)	h (cm)	U.Venta
32324	52,20	24	11,0	1

### Tapa

Couvercle  
Deckel  
Lid  
Tampa



Ref	€	Ø (cm)	U.Venta
32916	9,30	16	1
32920	11,20	20	1
32924	13,10	24	1
32928	16,40	28	1

### Colador esférico

Passoire à queue  
Seiher, mit Stiel  
Strainer  
Coador esférico



Ref	€	Ø (cm)	h (cm)	U.Venta
32318	37,70	18	8,5	1

### Pote cilíndrico

Pot-cilindrique  
Milchtopf  
Cylindrical pot  
Caneca cilíndrica



Ref	€	Ø (cm)	h (cm)	L	U.Venta
32714	24,60	14	12,5	1,50	1
32716	28,80	16	13,0	2,50	1

### Lote 4 cazos

Ensemble 4 casseroles  
Set 4 Tlg. Stielkasserollen  
Set 4 saucepans  
Lote de 4 çaçarola

Ref	€	U.Venta
32003	93,10	1

Ø14 cm  
Ø16 cm  
Ø18 cm  
Ø20 cm



# Batería NOVA-LADYCOR

Inox  
18/10



Sandwich



Vitro



Electric



Gas



Induction



Oven



Dishwasher



- Cuerpo fabricado en acero inoxidable 18/10.
- Asas, mangos y pomo en baquelita termoaislante.
- Destaca por su diseño clásico, funcionalidad y sencillez.
- Acabado pulido brillante exterior y lijado mate interior.
- Triple fondo difusor que asegura un eficiente reparto del calor.
- Apta para todo tipo de cocinas (incluido inducción). Apta para el lavavajillas.

- Corps fabriqué en acier inoxydable 18/10.
- Poignées, manches et pommeau en bakélite thermo-isolante.
- Se distingue par son style classique, sa fonctionnalité et sa simplicité.
- Finition polie brillante extérieur et limage mat intérieur.
- Triple fond diffuseur qui garantit une répartition efficace de la chaleur.
- Compatible avec tout type de cuisinières (y compris induction). Apte pour le lave-vaisselle.

- Körper aus nicht rostendem 18/10-Stahl.
- Griffe, Stiele und Deckelgriff aus wärmeabweisendem Bakelit.
- Punktet mit klassischem Design, Funktionalität und einfacher Handhabung.
- Hochglanzpolierte Außen- und glänzend matte Innenseite.
- Dreifachboden garantiert leistungsstarke Wärmeleitung.
- Für alle Herdarten geeignet (inkl. Induktion). Waschmaschinen tauglich.

- Body made in 18/10 stainless steel.
- Handles, grips and knob in heat resistant bakelite.
- Stands out for its classic design, functionality and simplicity.
- Exterior glossy, polished finish and sanded matte interior.
- Triple diffuser bottom assuring efficient distribution of heat.
- Suitable for all types of cooking surfaces (including induction). Dishwasher safe.

- Corpo fabricado em aço inoxidável 18/10.
- Asas, mangos e pomo em baquelite termo-isolante.
- Design clássico, prático e funcional.
- Acabamento exterior brilhante polido, e interior mate lixado.
- Fundo difusor triplo, para uma distribuição eficiente do calor.
- Apta para todo o tipo de fogões (incluido indução). Apta para máquinas de lavar louça.

## Cacerola con tapa

Faitout avec couvercle  
Bratentopf mit Deckel  
Casserole with lid  
Çaçarola com tampa



Ref	€	Ø (cm)	h (cm)	L	U.Venta
88016	44,40	16	8,0	1,50	1
88018	47,50	18	8,5	2,00	1
88020	51,70	20	8,5	2,50	1
88022	56,60	22	9,0	3,00	1
88024	60,40	24	9,5	3,50	1
88026	67,70	26	9,5	4,50	1
88028	82,40	28	11,0	9,50	1
88032	104,80	32	12,5	9,50	1

## Olla con tapa

Marmite avec couvercle  
Fleischtopf mit Deckel  
Stock pot with Lid  
Panela com tampa



Ref	€	Ø (cm)	h (cm)	L	U.Venta
88116	48,90	16	13,0	2,50	1
88118	51,60	18	14,0	3,50	1
88120	55,20	20	14,5	4,50	1
88122	60,40	22	14,5	5,50	1
88124	67,50	24	15,0	6,50	1
88126	75,00	26	15,0	7,50	1
88128	91,30	28	17,0	10,00	1
88132	110,20	32	17,5	13,50	1

## Olla super alta con tapa

Marmite S. Haute a/couvercle  
Hoher Fleischtopf mit Deckel  
Deep Stock pot with Lid  
Panela super alta com tampa



Ref	€	Ø (cm)	h (cm)	L	U.Venta
88121	60,30	20	17,5	5,50	1
88125	76,70	24	20,0	9,00	1
88129	108,00	28	22,0	13,50	1

## Cazo recto

Casserole  
Stielkasserole, flach  
Saucepan  
Çaçarola direite



Ref	€	Ø (cm)	h (cm)	L	U.Venta
88212	26,40	12	7,0	0,80	1
88214	27,30	14	7,5	1,00	1
88216	30,00	16	8,0	1,50	1
88218	32,90	18	8,5	2,00	1
88220	37,70	20	8,5	2,50	1

### Cacerola vapor

Panier vapeur  
Dampfkoch-Aufsatz  
Steam casserole  
Caçarola a vapor



Ref	€	Ø (cm)	h (cm)	L	U.Venta
88420	41,30	20	9,0	2,50	1
88424	50,70	24	10,5	3,50	1

### Tartera con tapa

Plat rond avec couvercle  
Pfanne mit Deckel  
Round dish with lid  
Tarteira com tampa



Ref	€	Ø (cm)	h (cm)	L	U.Venta
88620	51,30	20	6,5	2,00	1
88622	55,20	22	6,5	2,50	1
88624	59,20	24	7,0	3,00	1
88626	63,70	26	7,0	3,50	1
88628	72,50	28	8,0	4,50	1
88632	92,60	32	8,0	6,00	1

### Colador esférico

Passoire à queue  
Seiher, mit Stiel  
Strainer  
Coador esférico



Ref	€	Ø (cm)	h (cm)	U.Venta
88318	33,80	18	8,5	1

### Escurridera

Passoire sur pied  
Abtropfschüssel  
Colander with stand  
Escorredor



Ref	€	Ø (cm)	h (cm)	U.Venta
88324	47,80	24	11,0	1

### Pote cilíndrico

Pot-cilindrique  
Milchtopf  
Cylindrical pot  
Caneca cilíndrica



Ref	€	Ø (cm)	h (cm)	L	U.Venta
88712	28,90	12	12,0	1,00	1
88714	31,30	14	12,5	1,50	1
88716	34,20	16	13,0	2,50	1
88718	37,70	18	14,0	3,50	1

### Tapa

Couvercle  
Deckel  
Lid  
Tampa



Ref	€	Ø (cm)	U.Venta
88916	10,40	16	1
88918	10,60	18	1
88920	11,20	20	1
88922	11,50	22	1
88924	12,30	24	1
88926	13,80	26	1
88928	17,10	28	1
88932	23,40	32	1

# Batería ESTUDIO

Inox  
18/10



Sandwich



Vitro



Electric



Gas



Induction



Oven



Dishwasher



- Cuerpo fabricado en acero inoxidable 18/10.
- Asas, mangos y pomo en baquelita termoaislante.
- Su pomo abatible consigue una reducción del espacio manteniendo una ergonomía perfecta.
- Acabado pulido brillante exterior y lijado mate interior.
- Triple fondo difusor que asegura un eficiente reparto del calor.
- Apta para todo tipo de cocinas (incluido inducción). Apta para el lavavajillas.

- Corps fabriqué en acier inoxydable 18/10.
- Poignées, manches et pommeau en bakélite thermo-isolante.
- Son pommeau rabattable permet un gain d'espace en conservant une ergonomie parfaite.
- Finition extérieur polie brillante et intérieur limage mat.
- Triple fond diffuseur qui garantit une répartition efficace de la chaleur.
- Compatible avec tout type de cuisinières (y compris induction). Apte pour le lave-vaisselle.

- Körper aus nicht rostendem 18/10-Stahl.
- Griffe, Stiele und Deckelgriff aus wärmeabweisendem Bakelit.
- Mit umklappbarem Deckelgriff - platzsparend und sehr ergonomisch.
- Hochglanzpolierte Außen- und matt geschliffene Innenseite.
- Dreifachboden garantiert leistungsstarke Wärmeleitung.
- Für alle Herdarten geeignet (inkl. Induktion). Waschmaschinen tauglich.

- Body made in 18/10 stainless steel.
- Handles, grips and knob in heat resistant bakelite.
- Its folding knob reduces storage space maintaining ergonomic perfection.
- Exterior glossy, polished finish and sanded matte interior.
- Triple diffuser bottom assuring efficient distribution of heat.
- Suitable for all types of cooking surfaces (including induction). Dishwasher safe.

- Corpo fabricado em aço inoxidável 18/10.
- Asas, mangos e pomo em baquelite termo-isolante.
- O pomo rebatível permite reduzir o espaço ocupado conservando a sua ergonomia.
- Acabamento exterior brilhante polido, e mate lixado no interior.
- Fundo difusor triplo, para uma distribuição eficiente do calor.
- Apta para todo o tipo de fogões (incluindo placas de indução). Apta para máquinas de lavar louça.



**Pomo abatible**  
Folding knob

## Cacerola con tapa

Faitout avec couvercle  
Bratentopf mit Deckel  
Casserole with lid  
Caçarola com tampa



Ref	€	Ø (cm)	h (cm)	L	U.Venta
85016	44,90	16	8,0	1,50	1
85018	48,40	18	8,5	2,00	1
85020	52,80	20	8,5	2,50	1
85022	56,70	22	9,0	3,00	1
85024	61,10	24	9,5	3,50	1
85026	66,70	26	9,5	4,50	1
85028	76,80	28	11,0	6,50	1

## Olla con tapa

Marmite a/couvercle  
Fleischtopf mit Deckel  
Stock pot with Lid  
Panela com tampa



Ref	€	Ø (cm)	h (cm)	L	U.Venta
85118	51,50	18	14,0	3,50	1
85120	56,60	20	14,5	4,50	1
85122	61,80	22	14,5	5,50	1
85124	67,70	24	15,0	6,50	1
85126	72,90	26	15,0	7,50	1
85128	86,10	28	17,0	10,00	1

## Cazo recto

Casserole  
Stielkasserole, flach  
Saucepan  
Caçarola direite



Ref	€	Ø (cm)	h (cm)	L	U.Venta
85212	26,10	12	7,0	0,80	1
85214	27,30	14	7,5	1,00	1
85216	30,00	16	8,0	1,50	1
85218	33,30	18	8,5	2,00	1
85220	37,50	20	8,5	2,50	1



### Olla super alta con tapa

Marmite S. Haute a/couvercle  
Hoher Fleischtopf mit Deckel  
Deep Stock pot with Lid  
Panela super alta com tampa

Ref	€	Ø (cm)	h (cm)	L	U.Venta
85125	77,00	24	20,0	9,00	1
85129	95,00	28	22,0	13,50	1



### Cacerola vapor

Panier vapeur  
Dampfkoch-Aufsatz  
Steam casserole  
Caçarola a vapor

Ref	€	Ø (cm)	h (cm)	L	U.Venta
85420	39,60	20	9,0	2,50	1
85424	48,50	24	10,5	3,50	1



### Pote cilíndrico

Pot-cilindrique  
Milchtopf  
Cylindrical pot  
Caneca cilíndrica

Ref	€	Ø (cm)	h (cm)	L	U.Venta
85712	29,50	12	12,0	1,00	1
85714	31,60	14	12,5	1,50	1
85716	33,50	16	13,0	2,50	1
85718	37,20	18	14,0	3,50	1



### Sautex

Sauteuse  
Sauteuse  
Sauteuse  
Frigideira

Ref	€	Ø (cm)	h (cm)	L	U.Venta
85624	40,40	24	7,0	3,50	1



### Tapa

Couvercle  
Deckel  
Lid  
Tampa

Ref	€	Ø (cm)	U.Venta
85916	9,20	16	1
85918	9,90	18	1
85920	10,90	20	1
85922	11,10	22	1
85924	12,30	24	1
85926	12,80	26	1
85928	16,50	28	1



### Sartén

Poêle  
Pfanne  
Frying pan  
Sertãs

Ref	€	Ø (cm)	h (cm)	L	U.Venta
85625	38,20	24	7,0	3,50	1
85629	41,50	28	8,0	4,50	1

Ø12 cm  
Ø14 cm  
Ø16 cm  
Ø18 cm  
Ø20 cm



### Lote 5 cazos

Ensemble 5 casseroles  
Set 5 Tlg. Stielkasserollen  
Set 5 saucepans  
Lote de 5 caçarola

Ref	€	U.Venta
85003	154,10	1



# Batería TRIMETAL



- Cuerpo fabricado en 3 capas: acero inoxidable 18/10, aluminio, acero inoxidable 18%.
- El aluminio interior garantiza una cocción uniforme de los alimentos, además de un ahorro importante en el uso de energía.
- La capa exterior, es de acero inoxidable con componentes ferríticos, lo que la convierte totalmente compatible con las cocinas de inducción.
- Las asas y los mangos están fabricados en acero inoxidable 18/10 y recubiertas con un protector térmico de silicona para un agarre perfecto y seguro.
- La tapa de vidrio cuenta con un borde de silicona que le permite un cierre más eficiente y retener mayor calor, logrando así una mejor cocción.

- Corps fabriqué avec 3 couches : acier inoxydable 18/10, aluminium, acier inoxydable 18%.
- L'aluminium intérieur garantit une cuisson uniforme des aliments, ainsi qu'une importante économie de l'utilisation de l'énergie nécessaire.
- La couche extérieure est en acier inoxydable avec des composants ferritiques, ce qui lui permet d'être totalement compatible avec les cuisinières à induction.
- Les poignées et les manches sont fabriqués en acier inoxydable 18/10 et recouverts d'une protection thermique en silicone pour faciliter une prise en main parfaite et sûre.
- Le couvercle en verre possède un bord en silicone qui lui permet une fermeture plus efficace et de retenir davantage de chaleur, obtenant ainsi une meilleure cuisson.

- Körper aus dreilagigem Material: rostfreier Stahl 18/10, Aluminium, rostfreier Stahl 18%.
- Zwischenlage aus Aluminium gewährleistet gleichmäßigen Kochvorgang und wirkt energiesparend.
- Induktionsherdgeeignet dank Außenschicht aus rostfreiem Stahl mit ferritischen Bestandteilen. Die Griffe und Stiele aus rostfreiem Stahl 18/10 und mit wärmeabweisender Silikonummantelung geben sicheren und perfekten Halt.
- Der Glasdeckel mit Silikonumrandung sorgt für festen Verschluss und Wärmerückhalt und damit für einen optimierten Kochvorgang.

- Body manufactured in a 3-layered: 18/19 stainless steel, aluminium, 18% stainless steel.
- The interior aluminium guarantees uniform cooking of the food. Besides an important savings in the use of the necessary energy.
- Exterior layer, of stainless steel with ferrite materials, making it completely compatible with induction cookers.
- The handles and grips are made in 18/10 stainless steel and covered in a silicon heat protection for easy and safe gripping.
- The glass cover has a silicone border permitting a more efficient covering and heat retention, resulting in better cooking.

- Corpo fabricado em 3 capas: aço inoxidável 18/10, alumínio, aço inoxidável 18%.
- O interior de alumínio garante uma cocção uniforme dos alimentos, e uma grande poupança de energia.
- Capa exterior de aço inoxidável com componentes ferríticos, totalmente compatível com as placas de indução.
- Asas e mangos fabricados em aço Inoxidável 18/10, revestidos com um protetor térmico de silicone para uma sujeição perfeita e segura.
- Tampa de vidro com rebordo de silicone, para um fecho mais eficiente e uma maior retenção do calor, proporcionando uma cocção melhor dos alimentos.



## Cacerola con tapa

Faitout avec couvercle  
Bratentopf mit Deckel  
Casserole with lid  
Caçarola com tampa



Ref	€	Ø (cm)	h (cm)	L	U.Venta
53016	76,50	16	9,0	1,80	1
53018	88,90	18	10,0	2,50	1
53020	99,10	20	11,0	3,50	1
53024	117,60	24	13,0	5,50	1

## Cazo recto

Casserole  
Stielkasserole, flach  
Saucepan  
Caçarola direita



Ref	€	Ø (cm)	h (cm)	L	U.Venta
53214	51,00	14	7,0	0,80	1
53216	55,70	16	8,0	1,30	1
53218	61,50	18	9,0	2,00	1
53220	68,70	20	10,0	3,00	1

### Tapa

Couvercle  
Deckel  
Lid  
Tampa



Ref	€	Ø (cm)	U.Venta
53916	20,00	16	1
53918	20,50	18	1
53920	21,40	20	1
53924	22,30	24	1

### Sautex

Sauteuse  
Sauteuse  
Sauteuse  
Frigideira



Ref	€	Ø (cm)	h (cm)	L	U.Venta
53625	76,80	24	7,0	2,60	1

### Recubrimiento antiadherente TRlcapa Eclipse Plus

TRlcapa Eclipse Plus non-stick coating



### Sartén

Poêle  
Pfanne  
Frying pan  
Sertã

Ref	€	Ø (cm)	h (cm)	L	U.Venta
53720	57,80	20	4,5	1,00	1
53724	64,40	24	5,0	1,50	1
53728	78,90	28	5,5	2,50	1

### Sartén antiadherente

Poêle antiadherent  
Pfanne, Antihaft  
Non-stick frying pan  
Sertã anti-aderente

Ref	€	Ø (cm)	h (cm)	L	U.Venta
53721	68,00	20	4,5	1,00	1
53725	81,40	24	5,0	1,50	1
53729	102,80	28	5,5	2,50	1



### Wok

Wok  
Wok  
Wok  
Wok

Ref	€	Ø (cm)	h (cm)	L	U.Venta
53828	85,80	28	8,0	3	1

### Recubrimiento antiadherente TRlcapa Eclipse Plus

TRlcapa Eclipse Plus non-stick coating



### Wok antiadherente

Wok, Antiadherent  
Wok, Antihalt  
Wok, non-stick  
Wok anti-aderente

Ref	€	Ø (cm)	h (cm)	L	U.Venta
53829	97,50	28	8,0	3	1



# Batería GARINOX

Inox  
18/10



Sandwich



Vitro



Electric



Gas



Induction



Oven



Dishwasher



- Cuerpo fabricado en acero inoxidable 18/10.
- Asas, mangos y pomo en baquelita termoaislante.
- Acabado pulido brillante.
- Fondo Termodifusor (inox 18/10 - aluminio - inox).
- Apta para todo tipo de cocinas (incluido inducción).
- Apta para el lavavajillas.

- Corps fabriqué en acier inoxydable 18/10.
- Poignées, manches et pommeau en bakélite thermo-isolante.
- Finition polie brillante.
- Fond thermo-diffuseur (inox 18/10 - aluminium - inox).
- Compatible avec tout type de cuisinières (y compris induction).
- Apte pour le lave-vaisselle.

- Körper aus nicht rostendem 18/10-Stahl.
- Griffe, Stiele und Deckelgriff aus wärmeabweisendem Bakelit.
- Hochglanzpoliert.
- Wärmeleitender Boden (Edelstahl 18/10 - Aluminium - Edelstahl).
- Für alle Herdarten geeignet (inkl. Induktion).
- Waschmaschinen tauglich.

- Body made in 18/10 stainless steel.
- Handles, grips and knob in heat resistant bakelite.
- Glossy polished finish.
- Heat diffuser bottom (18/10 stainless steel - aluminium - stainless Steel).
- Suitable for all types of cooking surfaces (including induction).
- Dishwasher safe.

- Corpo fabricado em aço inoxidável 18/10.
- Asas, mangos e pomo em baquelite termo-isolante.
- Acabamento brilhante polido.
- Fundo termodifusor (inox 18/10 - alumínio - inox).
- Apta para todo o tipo de fogões (incluindo placas de indução).
- Apta para máquinas de lavar louça.

## Cacerola con tapa

Faitout a/couvercle  
Bratentopf mit Deckel  
Casserole with lid  
Çaçarola com tampa



Ref	€	Ø (cm)	h (cm)	L	U.Venta
14318	28,60	18	9,0	2,00	1
14320	33,00	20	10,0	3,00	1
14322	39,00	22	11,0	4,00	1
14324	45,00	24	12,0	5,00	1

## Olla con tapa

Marmite avec couvercle  
Fleischtopf mit Deckel  
Stock pot with Lid  
Panela com tampa



Ref	€	Ø (cm)	h (cm)	L	U.Venta
14420	35,40	20	12,0	3,80	1
14422	41,50	22	13,0	5,00	1
14424	49,70	24	15,0	7,00	1

## Cazo recto

Casserole  
Stielkasserole, flach  
Saucepan  
Çaçarola direite



Ref	€	Ø (cm)	h (cm)	L	U.Venta
14212	10,20	12	5,5	0,60	1
14214	12,70	14	6,5	1,50	1
14216	15,80	16	7,5	1,50	1
14218	19,10	18	9,0	2,00	1
14220	22,50	20	10,0	3,00	1

# Batería FORTE



- Fabricada en aluminio fundido y construida en una sola pieza.
- Máxima robustez y gran resistencia a la deformación.
- Ideal para guisos, cocidos, sopas y salsas.
- Revestimiento antiadherente interior y exterior, libre de PFOA.
- Apta para todo tipo de cocinas (incluido inducción).
- Incluye una tapa de vidrio templado con válvula resistente a los golpes.

- Fabriqué en fonte d'aluminium et construite en une seule pièce.
- Robustesse maximale et grande résistance à la déformation.
- Idéale pour les ragoûts, pot-au-feu, soupes et sauces.
- Revêtement antiadhésif intérieur et extérieur sans PFOA.
- Compatible avec tout type de cuisinières (y compris induction).
- Inclut un couvercle en verre trempé avec soupape résistante aux chocs.

- In einem Stück aus Aluminium gegossen.
- Höchst widerstandsfähig und formbeständig.
- Ideal für Schmorgerichte, Eintöpfe, Suppen und Soßen.
- Antihafbeschichtung innen und außen, ohne PFOA.
- Für alle Herdarten geeignet (inkl. Induktion).
- Deckel aus gehärtetem Glas mit stoßfestem Ventil.

- Made in Cast Aluminium and in a single piece.
- Maximum robustness and great resistance to deformation.
- Ideal product for stews, soups and sauces.
- Interior non-stick coating and exterior, PFOA free.
- Suitable for all types of cooking surfaces (including induction).
- It includes a tempered glass cover with pressure valve resistant to bumps.

- Fabricada em alumínio fundido e como uma única peça.
- Máxima robustez e grande resistência à deformação.
- Ideal para estofados, cozidos, sopas e molhos.
- Revestimento antiaderente interior e exterior, isento de PFOA.
- Apta para todo o tipo de fogões (incl. placas de indução).
- Tampa de vidro temperado com válvula, resistente aos golpes.

## Cacerola con tapa cristal

Faitout avec couvercle verre  
Bratentopf mit Glasdeckel  
Round casserole with glass lid  
Caçarola com tampa de vidro



Ref	€	Ø (cm)	h (cm)	L	U.Venta
25816	31,60	16	8,5	1,50	1
25820	34,20	20	8,5	2,50	1
25824	42,70	24	10,5	4,50	1
25828	52,30	28	12,5	7,00	1
25831	62,10	30	13,5	8,70	1

## Cacerola baja con tapa cristal

Faitout bas avec couvercle verre  
Bratentopf mit Glasdeckel  
Round low casserole with glass lid  
Caçarola baixa com tampa de vidro



Ref	€	Ø (cm)	h (cm)	L	U.Venta
25823	42,90	24	7,5	2,60	1
25827	52,60	28	7,5	3,60	1
25832	68,10	32	7,5	5,20	1
25835	78,80	36	8,5	7,50	1

## Cacerola cuadrada con tapa cristal

Faitout carré avec couvercle verre  
Bratentopf mit Glasdeckel  
Square casserole with glass lid  
Caçarola quadrada com tampa de vidro



Ref	€	cm	h (cm)	L	U.Venta
25825	49,20	24x24	10,0	4,70	1
25829	61,80	28x28	12,0	7,50	1

# Batería TITANIUM<sup>PRO</sup>



- Cacerola robusta y duradera gracias a su cuerpo fabricado en aluminio fundido.
- Fabricada en una sola pieza.
- Antiadherente TRIcapa Quantanium. Recubrimiento de máxima calidad reforzada con partículas a base de titanio.
- Libre de materiales pesados y tóxicos. ECO y libre de PFOA.
- Compatible con todas las fuentes de calor, incluida la inducción.
- Fácil limpieza interior y exterior.

- Casserole robuste et durable grâce à son corps fabriqué en fonte d'aluminium.
- Fabriquée en une seule pièce.
- Antiadhésif Tri-couche Quantanium. Revêtement de la plus grande qualité renforcé avec des particules à base de titane.
- Sans matériaux lourds et toxiques. ECO et sans PFOA.
- Compatible avec toutes les sources de chaleur, y compris l'induction.
- Nettoyage intérieur et extérieur facile.

- Solider und haltbarer Kochtopf aus Aluminiumguss.
- Aus einem Stück.
- Dreilagige Antihafbeschichtung Quantanium Äußerst hochwertige Beschichtung mit Titanbeimischung
- Frei von Schwermetallen und Giftstoffen ECO-zertifiziert und PFOA-frei.
- Für alle Herdarten geeignet, einschließlich Induktion.
- Innen und außen einfach zu reinigen.

- Robust and durable casserole thanks to its cast aluminium body.
- One piece construction.
- Non-stick TRI-layer. Quantanium top quality coating reinforced with titanium-based particles.
- Free of heavy and toxic materials. ECO and PFOA-free.
- Compatible with all heat sources, including induction.
- Easy to clean interior and exterior

- Caçarola robusta e durável, graças ao seu corpo fabricado em alumínio fundido
- Fabricada numa só peça.
- Antiaderente TRIcapa Quantanium. Revestimento da máxima qualidade, reforçado com partículas à base de titânio.
- Não contém materiais pesados e tóxicos. ECO e livre de PFOA.
- Compatível com todas as fontes de calor, incluindo placas de indução.
- Fácil limpeza interior e exterior.

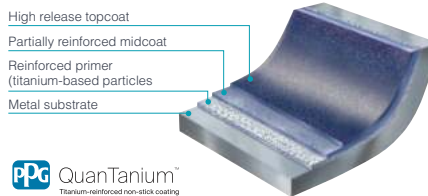
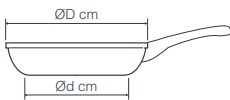

PPG Quantanium<sup>™</sup>  
Titanium-reinforced non-stick coating



- **Tapa de vidrio templado reforzada con un aro protector de silicona antipactos y una válvula de salida de vapor.**
- Couvercle en verre trempé renforcé avec un pourtour de protection en silicone anti-impacts et une valve de sortie de vapeur.
- Deckel aus gehärtetem Glas, stoßfest, verstärkt mit Schutzring aus Silikon, mit Druckregelventil.
- Tempered glass lid reinforced with an anti-shock silicone protective ring and a steam outlet valve.
- Tampa de vidro temperado, reforçada com um aro protetor de silicone anti-impactos e com válvula de saída de vapor.



- **Asas EXTRAÍBLES fabricadas en silicona de máxima calidad, termoaislantes, altamente resistentes y ergonómicas, permiten un agarre seguro. Mango con acabado SOFT TOUCH, termoaislante, altamente resistente y ergonómico, permite un agarre seguro.**
- Poignées AMOVIBLES fabriquées en silicone de la plus grande qualité, thermo-isolantes, hautement résistantes et ergonomiques, qui permettent de tenir l'ustensile en toute sécurité. Manche avec finition SOFT TOUCH, thermo-isolant, hautement résistant et ergonomique, permet une prise en main sûre.
- Hochwertige, ergonomische ABNEHMBARE Silikongriffe mit hoher Temperaturfestigkeit gewährleisten ein sicheres Halten des Geschirrs. Soft-Touch-Stiel, wärmeisoliert, hoch widerstandsfähig und ergonomisch, sorgt für sicheren Halt.
- Heat insulating, highly resistant, ergonomic REMOVABLE handles made of high quality silicone which provide a secure grip on pots and pans. Handle with SOFT TOUCH finish, heat insulating, highly resistant and ergonomic, allows a secure grip.
- Asas REMOVÍVEIS fabricadas em silicone de grande qualidade, termo-isolantes, altamente resistentes e ergonómicas, que permitem agarrar a peça com segurança. Mango com acabamento SOFT TOUCH, termo-isolante, altamente resistente e ergonómico, que permite uma sujeição segura.



- **Fondo difusor FULL INDUCTION; asegura un rendimiento óptimo en todo tipo de cocinas, con un reparto de calor inmejorable logrando la máxima eficiencia y ahorro de energía.**
- Fond diffuseur FULL INDUCTION ; garantit un rendement optimal sur tout type de cuisinière, avec une répartition de la chaleur unique, obtenant ainsi une efficacité et une économie d'énergie maximales.
- Wärmeverteiler Boden FULL INDUCTION für optimale Leistung bei allen Herdtypen, mit hervorragender Wärmeverteilung, maximale Effizienz und Energieeinsparung.
- The FULL INDUCTION diffuser base ensures optimum performance with all kinds of cookers. Its unbeatable heat distribution achieves the best efficiency and energy savings.
- Fundo difusor FULL INDUCTION, que assegura um ótimo rendimento em todo o tipo de placas de cocção e fogões, com excelente distribuição do calor, para máxima eficiência e economia energética.

**Incluye asas de silicona**  
Includes silicone handles



### Cacerola con tapa

Faitout avec couvercle  
Bratentopf mit Deckel  
Casserole with lid  
Çaçarola com tampa

Ref	€	Ø (cm)	h (cm)	L	U.Venta
27520	50,60	20	9,5	2,60	1
27524	61,20	24	11,0	4,40	1
27528	74,50	28	12,0	6,60	1



### Cazo recto

Casserole  
Stielkasserolle, flach  
Saucepan  
Çaçarola direita



Ref	€	Ø (cm)	h (cm)	L	U.Venta
27516	29,30	16	8,0	1,35	1

**Incluye asas de silicona**  
Includes silicone handles



### Tartera con tapa

Plat rond avec couvercle  
Pfanne mit Deckel  
Round dish with lid  
Tarteira com tampa

Ref	€	Ø (cm)	h (cm)	L	U.Venta
27728	69,70	28	7,5	4,10	1
27732	83,60	32	8,0	5,70	1
27736	98,50	36	8,0	7,30	1



### Sartén

Poêle  
Pfanne  
Frying-pan  
Sertã



Ref	€	ØD (cm)	Ød (cm)	h (cm)	U.Venta
27820	30,70	20	16,6	5,0	6
27824	37,80	24	20,2	5,5	4
27828	45,90	28	23,4	6,0	6



4 in 1

**Compartimentos individuales**  
Individual compartments



### Grill

Grill  
Grill Induktionfähig  
Grill  
Grelhador

Ref	€	cm	Ød (cm)	h (cm)	U.Venta
27827	53,40	28x28	21,0	4,0	1



### Sartén 4 cavidades

Poêle 4 cavités  
Pfanne, 4-fache Einteilung  
Frying-pan 4 cavities  
Sertã 4 cavidades

Ref	€	cm	Ød (cm)	h (cm)	U.Venta
27832	46,20	32x26	21,0	3,5	1



**Aro protector de silicona**  
Silicone protective ring



### Tapa de cristal

Couvercle en verre  
Glasdeckel  
Glass lid  
Tampa de vidro

Ref	€	Ø (cm)	U.Venta
27420	10,40	20	1
27424	12,10	24	1
27428	14,00	28	1
27432	15,90	32	1
27436	17,70	36	1

**Válvula salida de vapor**  
Steam outlet valve

### Si

Silicone

### Asas para batería TITANIUM

Poignées  
Griffchutz, Silikon  
Handles  
Asas

Ref	€	Ø (cm)	U.Venta
R27520A	4,30	20	1
R27528A	4,40	24-28	1
R27732A	5,50	32-36	1



# Batería FIT



- Gracias al tratamiento electrolítico empleado en su proceso de fabricación, el aluminio se sella completamente y se endurece para que no pase a los alimentos.
- Antiadherente QuanTanium® reforzado con partículas de titanio; libre de tóxicos, materiales pesados y sin PFOA.
- Gran durabilidad y ultrarresistente: superficie robusta altamente resistente a roces, deformación y corrosión.
- Difunde el calor de forma uniforme evitando el sobrecalentamiento y obteniendo excelentes resultados de cocción.
- Mangos / Asas de acero inoxidable con remaches de aluminio que impiden la transferencia de calor.
- Tapas de vidrio templado reforzadas en el borde con acero inoxidable.
- Compatible con todas las fuentes de calor, incluida la inducción.

- Grâce au traitement électrolytique utilisé lors de son processus de fabrication, l'aluminium est totalement scellé et durci pour ne pas pouvoir atteindre les aliments.
- Revêtement antiadhésif QuanTanium® renforcé avec des particules de titane; sans produits toxiques, sans matériaux lourds et sans PFOA.
- Grande durabilité et ultra résistante : Surface robuste hautement résistante aux rayures, à la déformation et à la corrosion.
- Diffuse la chaleur de façon uniforme, évitant ainsi la surchauffe et obtenant d'excellents résultats de cuisson.
- Anses et poignées en acier inoxydable avec des rivets en aluminium qui empêchent le transfert de chaleur.
- Couverts en verre trempé renforcés avec le bord en acier inoxydable.
- Compatible avec toutes les sources de chaleur, y compris l'induction.

- Dank der elektrolytischen Behandlung während des Herstellungsprozesses wird das Aluminium komplett versiegelt und härtet aus, um die Lebensmittel nicht zu kontaminieren.
- Antihafbeschichtung QuanTanium®, verstärkt mit Titanpartikeln; frei von Giftstoffen, Schwermetallen und PFOA-frei.
- Lange Haltbarkeit und äußerst beständig: robuste, verformungs-, kratz- und korrosionsbeständige Oberfläche.
- Gleichmäßige Wärmeverteilung bei Vermeidung von Überhitzungen für hervorragende Kochergebnisse.
- Griffe / Stiele aus Edelstahl mit Aluminiumnieten zur Vermeidung von Wärmeübertragungen.
- Gehärteter Glasdeckel mit edelstahlverstärktem Rand.
- Für alle Herdarten geeignet, einschließlich Induktion.

- Because of the electrolytic treatment used in the manufacturing process, the aluminium is completely sealed and hardened so no metal is passed on to the food.
- Non-stick QuanTanium®, reinforced with titanium particles, is free of toxins, heavy metals and PFOA.
- Extremely durable and ultra-high strength: It has a robust surface that is highly resistant to abrasion, warping and corrosion.
- It distributes heat evenly to avoid overheating and provide excellent cooking results.
- Stainless steel handles with aluminium rivets that avoid heat transfer.
- The lid is tempered glass with stainless steel reinforcement around the edge.
- Compatible with all heat sources, including induction.

- O tratamento eletrolítico utilizado no processo de fabrico sela e endurece o alumínio, evitando a contaminação dos alimentos com partículas de metal.
- Antiaderente QuanTanium® reforçado com partículas de titânio, sem produtos tóxicos, materiais pesados ou PFOA.
- Grande durabilidade e ultra resistente: superfície robusta, altamente resistente à fricção, deformação e corrosão.
- Difunde o calor de forma uniforme, evitando o sobreaquecimento, com excelentes resultados de cocção.
- Mango/Asas em aço inoxidável com rebites de alumínio que impedem a transferência do calor.
- Tampas de vidro temperado, com rebordo reforçado em aço inoxidável.
- Compatível com todas as fontes de calor, incluindo placas de indução.

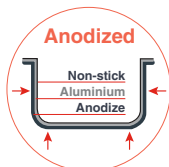

**Capa de óxido natural de protección muy gruesa**  
 Couche d'oxydation naturelle de protection très épaisse  
 Natürliche, sehr dicke Oxidationsschutzschicht  
 Thick natural oxide protective layer  
 Capa de óxido natural com proteção grossa



**Muy resistentes a arañazos, deformaciones y corrosión**  
 Très résistante aux rayures, à la déformation et à la corrosion  
 Äußerst kratzfest, verformungssteif und korrosionsbeständig  
 Very resistant to scratches, deformation and corrosion  
 Muito resistentes a riscos, deformação e corrosão

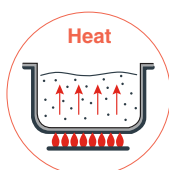

**Distribuye uniformemente el calor, sin áreas de sobrecalentamientos**  
 Distribue uniformément la chaleur, sans zones de surchauffe  
 Gleichförmige Wärmeübertragung ohne Überhitzungen  
 Hot spot free, uniform heat distribution  
 Distribui uniformemente o calor, sem áreas de sobreaquecimento

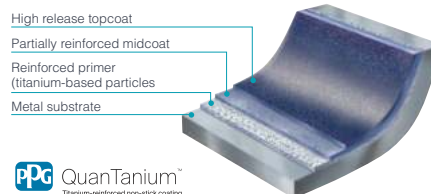

**PPG** QuanTanium™  
 Titanium-reinforced non-stick coating

### Cacerola con tapa

Faitout avec couvercle  
Bratentopf mit Deckel  
Casserole with lid  
Caçarola com tampa



Ref	€	Ø (cm)	h (cm)	L	e (mm)	U.Venta
48016	42,60	16	8,0	1,50	4,5	1
48020	51,70	20	9,0	2,60	4,5	1
48024	63,50	24	10,0	4,20	4,5	1
48028	74,60	28	11,0	6,30	4,5	1

### Olla con tapa

Marmite avec couvercle  
Fleichtopf mit Deckel  
Stock pot with lid  
Panela com tampa



Ref	€	Ø (cm)	h (cm)	L	e (mm)	U.Venta
48116	49,10	16	13,0	2,50	4,5	1
48120	58,10	20	14,0	4,20	4,5	1
48124	73,00	24	15,0	6,50	4,5	1
48128	87,20	28	17,0	10,00	4,5	1

### Cazo recto

Casserole  
Stielkasserolle, flach  
Saucepan  
Caçarola direite



Ref	€	Ø (cm)	h (cm)	L	e (mm)	U.Venta
48214	29,60	14	7,5	1,00	4,5	1
48216	33,00	16	8,0	1,50	4,5	1
48218	37,10	18	9,0	2,10	4,5	1
48220	42,00	20	10,0	2,90	4,5	1

### Tartera con tapa

Plat rond avec couvercle  
Pfanne mit Deckel  
Round dish with lid  
Tarteira com tampa



Ref	€	Ø (cm)	h (cm)	L	e (mm)	U.Venta
48624	57,30	24	7,0	2,90	4,5	1
48628	68,50	28	8,0	4,50	4,5	1

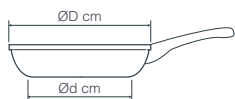

### Sartén

Poêle  
Pfanne  
Frying pan  
Sertã



Ref	€	ØD (cm)	Ød (cm)	h (cm)	L	e (mm)	U.Venta
48720	32,30	20	15,0	4,0	0,90	4,5	6
48724	40,40	24	18,0	4,5	1,50	4,5	6
48728	48,20	28	22,0	5,0	2,70	4,5	6

### Tapa

Couvercle  
Deckel  
Lid  
Tampa



Ref	€	Ø (cm)	U.Venta
48916	12,00	16	1
48920	13,50	20	1
48924	14,90	24	1
48928	16,60	28	1

Vidrio templado  
Tempered glass

Aro protector de acero inoxidable  
Stainless steel protective ring

Válvula salida de vapor  
Steam outlet valve



# Batería EASY

new



- Fabricadas en aluminio forjado de máxima calidad.
- Excelente conductividad térmica.
- Recubrimiento antiadherente TRlcapa, reforzado a base de partículas de piedra.
- Libres de materiales tóxicos y pesados, ecológico y 100% libre de PFOA.
- Fondo FULL INDUCTION compatible con todas las fuentes de calor, incluida la inducción.
- Asas / Mango de fundición de acero inoxidable.
- Tapa de vidrio templado reforzada en el borde con acero inoxidable.

- Fabriquée en aluminium forgé de la plus grande qualité.
- Excellente conductivité thermique.
- Revêtement antiadhésif TRlcapa, renforcé à base de particules de pierre.
- Sans matériaux toxiques ni métaux lourds, écologique et 100% sans PFOA.
- Fond FULL INDUCTION compatible avec toutes les sources de chaleur, y compris l'induction.
- Poignées / Manche en fonte d'acier inoxydable.
- Couvercle en verre trempé renforcé sur le bord avec de l'acier inoxydable.

- Aus geschmiedetem Aluminium bester Qualität.
- Hervorragende Wärmeleitfähigkeit.
- TriCAPA Antihafbeschichtung, verstärkt mit Steinbeimischung.
- Ohne toxische Materialien oder Schwermetalle, umweltfreundlich und 100 % frei von PFOA.
- FULL INDUCTION-Boden für alle Herdarten geeignet, einschließlich Induktion.
- Griffe / Stiel aus Edelstahlguss.
- Deckel aus gehärtetem Glas außen verstärkt mit Edelstahl.

- Made of top quality forged aluminium.
- Excellent thermal conductivity.
- TRlcapa non-stick coating, reinforced with stone particles.
- Free of toxic, heavy materials, environmentally friendly and 100% PFOA-free.
- With FULL INDUCTION base and compatible with all heat sources, including induction.
- Cast stainless steel grips / handle.
- Tempered glass lid with reinforced stainless steel edge.

- Fabricadas em alumínio forjado da máxima qualidade.
- Excelente condutividade térmica.
- Revestimento antiaderente TRlcapa, reforçado com partículas de pedra.
- Não contém materiais tóxicos e pesados. Ecológica e 100% livre de PFOA.
- Fundo FULL INDUCTION compatível com todas as fontes de calor, incluindo as placas de indução.
- Asas / Cabo em aço fundido inoxidável.
- Tapa de vidro temperado reforçada na borda com aço inoxidável.



**Recubrimiento antiadherente TRlcapa, reforzado a base de partículas de piedra**  
TRlcapa non-stick coating, reinforced with stone particles

**Aro protector de acero inoxidable**  
Stainless steel protective ring

**Asas de fundición de acero inoxidable**  
Cast stainless steel handle

**Tapa de vidrio templado**  
Tempered glass lid

**Válvula de salida vapor**  
Steam outlet valve

**Fondo Full induction**  
Full induction base





### Cacerola con tapa

Faitout avec couvercle  
Bratentopf mit Deckel  
Casserole with lid  
Caçarola com tampa

Ref	€	Ø (cm)	h (cm)	L	e (mm)	U.Venta
27040	47,30	20	8,5	2,00	3,00	1
27044	59,10	24	10,5	3,50	3,00	1
27048	71,20	28	12,5	6,00	3,00	1



### Cacerola baja con tapa

Faitout bas avec couvercle  
Bratentopf mit Deckel  
Round low casserole with lid  
Caçarola baixa com tampa

Ref	€	Ø (cm)	h (cm)	L	e (mm)	U.Venta
27034	50,10	24	6,5	2,00	3,00	1
27038	58,80	28	7,0	3,00	3,00	1



### Cazo recto

Casserole  
Stielkasserolle, flach  
Saucepan  
Caçarola direita

Ref	€	Ø (cm)	h (cm)	L	e (mm)	U.Venta
27056	33,50	16	7,5	1,00	3,00	1
27058	36,60	18	8,0	1,50	3,00	1
27060	40,50	20	8,5	2,00	3,00	1



### Mango de fundición de acero inoxidable

Cast stainless steel handle



### Sartén

Poêle  
Pfanne  
Frying-pan  
Sertã

Ref	€	ØD (cm)	Ød (cm)	h (cm)	e (mm)	U.Venta
27018	20,50	18	x	4,0	3,0	6
27020	21,30	20	x	4,0	3,0	6
27022	23,10	22	x	4,5	3,0	6
27024	25,00	24	x	4,5	3,0	6
27026	27,20	26	x	5,0	3,0	6
27028	29,80	28	x	5,5	3,0	6
27030	32,60	30	x	5,5	3,0	6
27032	34,50	32	x	6,0	3,0	6

**Aro protector de acero inoxidable**  
Stainless steel protective ring

**Vidrio templado**  
Tempered glass



### Tapa

Couvercle  
Deckel  
Lid  
Tampa

Ref	€	Ø (cm)	U.Venta
27070	11,30	20	1
27074	13,10	24	1
27078	14,20	28	1

**Válvula salida de vapor**  
Steam outlet valve

# Batería STILO



- Construidas en aluminio fundido de una sola pieza.
- Garantiza una resistencia máxima y una distribución homogénea del calor.
- Revestimiento antiadherente de alta calidad y ecológico, libre de PFOA.
- Reforzada con un acabado en piedra.
- Pomo y asa SOFT TOUCH.
- Tapa de cristal con cierre de silicona.
- Apta para todo tipo de cocinas, incluida la inducción.

- Fabriquéés en fonte d'aluminium d'une seule pièce.
- Garantit une résistance maximale et une distribution homogène de la chaleur.
- Revêtement antiadhésif de grande qualité et écologique, sans PFOA.
- Renforcée avec une finition en pierre.
- Pommeau et poignée SOFT TOUCH.
- Couvercle en verre avec fermeture en silicone.
- Compatible avec tout type de cuisinières, y compris à induction.

- In einem Stück aus Aluminium gegossen.
- Gewährleistet höchste Widerstandsfähigkeit und gleichmäßige Wärmeverteilung.
- Umweltfreundliche und qualitätsvolle Antihafbeschichtung ohne PFOA.
- Mit Steinbeschichtung gehärtet.
- SOFT TOUCH-Griffe.
- Glasdeckel mit Silikondichtung.
- Für alle Herdarten geeignet, inkl. Induktion.

- Made in a single, cast aluminum body.
- This guarantees maximum resistance and a homogeneous distribution of heat.
- Its high quality and eco-friendly non-stick coating is PFOA-free.
- Reinforced with a stone finish.
- SOFT TOUCH knob and handle.
- Glass cover with silicone seal.
- Apt for all types of cooking surfaces (including induction).

- Fabricadas em alumínio fundido de uma só peça.
- Oferece máxima resistência e uma distribuição homogênea do calor.
- Revestimento antiaderente de alta qualidade e ecológico, isento de PFOA.
- Reforçadas com acabamento em pedra.
- Pomo e asa SOFT TOUCH.
- Tampa de vidro com fecho de silicone.
- Aptas para todo o tipo de placas, incluindo as de indução.

## Pomos y asas presentan un aspecto de madera Acabado SOFT TOUCH

Knobs and handles have a wooden look  
SOFT TOUCH finish

## La tapa de cristal se ajusta perfectamente con el cierre de silicona

The glass lid fits perfectly with silicone seal



## Recubrimiento antiadherente acabado en piedra

Non-stick coating finished in stone



### Cacerola con tapa cristal

Faitout avec couvercle verre  
Bratentopf mit Glasdeckel  
Casserole with glass lid  
Caçarola com tampa de vidro

Ref	€	Ø (cm)	h (cm)	L	U.Venta
27320	52,10	20	10,5	2,50	1
27324	60,40	24	12,0	4,00	1
27328	71,20	28	12,5	6,00	1



### Cacerola baja con tapa cristal

Faitout bas avec couvercle verre  
Bratentopf mit Glasdeckel  
Low casserole with glass lid  
Caçarola baixa com tampa de vidro

Ref	€	Ø (cm)	h (cm)	L	U.Venta
27327	67,50	28	8,5	4,00	1



### Cazo recto

Casserole  
Stielkasserole, flach  
Saucepan  
Caçarola direita

Ref	€	Ø (cm)	h (cm)	L	U.Venta
27416	33,20	16	7,5	1,20	1
27418	35,40	18	8,8	1,80	1

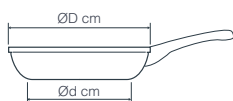

### Sartén

Poêle  
Pfanne  
Frying pan  
Sertã



Ref	€	ØD (cm)	Ød (cm)	h (cm)	U.Venta
27620	34,60	20	16,5	4,5	6
27624	39,50	24	20,0	5,2	6
27626	43,60	26	21,5	5,5	6
27628	47,10	28	24,0	6,0	6

Aro protector de silicona  
Silicone protective ring

### Tapa cristal

Couvercle verre  
Glasdeckel  
Glass lid  
Tampa de vidro



Válvula salida de vapor  
Steam outlet valve

Ref	€	Ø (cm)	U.Venta
27920	9,00	20	1
27924	10,30	24	1
27928	12,70	28	1

### Grill

Grill  
Grill Induktionfähig  
Grill  
Grelhador



Ref	€	cm	Ød (cm)	h (cm)	U.Venta
27625	43,60	24x24	18,6	4,8	1
27629	50,50	28x28	21,5	5,2	1

# Batería **COCOTTES**



- Fabricadas en aluminio fundido. Diseño atractivo y funcional.
- Garantizan la absorción y distribución uniforme del calor, sin puntos de sobrecalentamiento.
- La distribución del calor uniforme por toda la pieza hace que los alimentos no pierdan su jugo durante la cocción, conservando así todos sus nutrientes y vitaminas.
- Las puntas situadas bajo la tapa, hacen que las gotas fruto de la condensación, vuelvan a caer sobre los alimentos formando un flujo circulante y permanente reduciendo la pérdida de sabores y jugos de los alimentos.
- Es la pieza perfecta para: arroces, carnes, pescados, legumbres, verduras, guisos, cremas, salsas, sopas, etc.
- Revestimiento antiadherente ILAG:ULTIMATE.

- Fabriquée en fonte d'aluminium. Style attractif et grande fonctionnalité.
- Garantit l'absorption et la distribution uniforme de la chaleur, sans points de surchauffe.
- La distribution de la chaleur uniforme sur toute la pièce permet aux aliments de ne pas perdre leur jus pendant la cuisson, conservant ainsi tous leurs nutriments et vitamines.
- Les pointes situées sous le couvercle permettent aux gouttes issues de la condensation de retomber sur les aliments, formant ainsi un flux permanent de circulation qui réduit la perte des saveurs et des jus des aliments.
- C'est la pièce parfaite pour : riz, viandes, poissons, légumes, ragoûts, crèmes, sauces, soupes, etc.
- Revêtement antiadhésif ILAG: ULTIMATE.

- Made in cast aluminium. Attractive design and great functionality.
- It guarantees the absorption and uniform distribution of heat, without overheating points.
- The uniform distribution of heat throughout the product makes keep its juices during cooking, preserving all its nutrients and vitamins.
- The points located under the lid cause the condensation drops to fall back onto the food, forming a permanent and circulating flow and reducing the loss of the food's flavours and juices.
- This is an ideal product for: rice, meats, fish, beans, vegetables, stews, creams, sauces, soups, etc.
- Non-stick coating ILAG: ULTIMATE.



**Las puntas situadas bajo la tapa, hacen que las gotas fruto de la condensación, vuelvan a caer sobre los alimentos formando un flujo circulante y permanente reduciendo la pérdida de sabores y jugos de los alimentos.**

The points located under the lid cause the condensation drops to fall back onto the food, forming a permanent and circulating flow and reducing the loss of the food's flavours and juices.

## Cacerola con tapa MINI

Faitout avec couvercle "MINI"  
"MINI" Bratentopf mit Deckel  
"MINI" round casserole with lid  
Çaçarola com tampa "MINI"



Ref	€	Ø (cm)	h (cm)	L	U.Venta
25909	22,50	10	5,0	0,24	12
25914	33,00	14	7,5	0,90	1

## Cacerola con tapa MINI negra

Faitout avec couvercle MINI noir  
MINI Bratentopf mit Deckel, grau  
"MINI" black round casserole with lid  
Çaçarola com tampa MINI negra



Ref	€	Ø (cm)	h (cm)	L	U.Venta
25910	22,50	10	5,0	0,24	1
25915	33,00	14	7,5	0,90	1

## Cacerola oval con tapa MINI

Faitout Ovale avec couvercle "MINI"  
"MINI" Oval Bratentopf mit Deckel  
"MINI" oval round casserole with lid  
Çaçarola oval com tampa "MINI"



Ref	€	cm	h (cm)	L	U.Venta
25911	23,70	12x8,5	5,0	0,25	1

## Cacerola oval c/tapa MINI negra

Faitout ovale avec couvercle MINI noir  
MINI Oval Bratentopf mit Deckel, grau  
"MINI" black oval round casserole with lid  
Çaçarola oval com tampa MINI negra



Ref	€	cm	h (cm)	L	U.Venta
25912	22,40	12x8,5	5,0	0,25	1

### Cacerola con tapa

Faitout avec couvercle  
Bratentopf mit Deckel  
Round casserole with lid  
Caçarola com tampa



Ref	€	Ø (cm)	h (cm)	L	U.Venta
25916	48,60	16	7,0	1,30	1
25920	63,30	20	8,0	2,40	1
25924	81,70	24	10,0	4,20	1
25928	104,20	28	11,5	6,70	1

Incluye asas de silicona  
Includes silicone handles

### Cacerola con tapa negra

Faitout avec couvercle noir  
Bratentopf mit Deckel, grau  
Black round casserole with lid  
Caçarola com tampa negra



Ref	€	Ø (cm)	h (cm)	L	U.Venta
25917	54,00	16	7,0	1,30	1
25921	71,20	20	8,0	2,40	1
25925	89,10	24	10,0	4,20	1
25929	109,00	28	11,5	6,70	1

### Cacerola oval con tapa

Faitout Ovale avec couvercle  
Oval Bratentopf mit Deckel  
Oval round casserole with lid  
Caçarola oval com tampa



Ref	€	cm	h (cm)	L	U.Venta
25927	75,30	26x20	9,0	3,50	1
25931	103,40	31x25	11,0	6,30	1

Incluye asas de silicona  
Includes silicone handles

### Cacerola oval c/apa negra

Faitout ovale avec couvercle noir  
Oval Bratentopf mit Deckel, grau  
Black oval round casserole with lid  
Caçarola oval com tampa negra



Ref	€	cm	h (cm)	L	U.Venta
25933	81,30	26x20	9,0	3,50	1
25935	112,00	31x25	11,0	6,30	1

### Si

Silicone

### Manoplas de silicona GRIS

Mouflettes en silicone  
Griffchutz aus Silikon  
Silicone mitten  
Pegas de silicone

Ref	€	Ø (cm)	U.Venta
R25917G	8,20	16	6
R25921G	7,80	20-24-28	6
R25933G	8,20	26x20	6
R25935G	7,80	31x25	6



Protección total  
Full protection

### Cazo recto

Casserole  
Stielkasserole, flach  
Saucepan  
Caçarola direita



Ref	€	ØD (cm)	Ød (cm)	h (cm)	e (mm)	L	U.Venta
25956	29,70	16	12,0	8,0	1,6	1,30	1
25958	33,30	18	15,0	8,5	1,6	1,80	1
25950	36,50	20	16,5	9,0	1,6	2,40	1

new

**Full Induction**  
TOTAL



Revestimiento antiadherente  
**Xylan Plus**  
Nonstick coating



Incluye asas de silicona  
Includes silicone handles

### Paellera COCOTTE

Plat rond  
Pfanne  
Round  
Paelheira

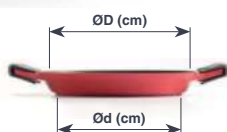

Ref	€	ØD (cm)	Ød (cm)	h (cm)	e (mm)	Raciones	U.Venta
25932	82,10	32	25,5	4,5	1,6	5	1
25936	95,90	36	29,5	4,5	2,0	7	1
25940	106,60	40	33,5	4,5	2,0	9	1

- Fabricadas en aluminio fundido.
- Garantizan la absorción y distribución uniforme del calor, sin puntos de sobrecalentamiento.
- La distribución del calor uniforme por toda la pieza hace que los alimentos no pierdan su jugo durante la cocción, conservando así todos sus nutrientes y vitaminas.
- Fondo difusor FULL INDUCTION; asegura un rendimiento óptimo en todo tipo de cocinas, con un reparto de calor inmejorable logrando la máxima eficiencia y ahorro de energía.
- Perfectas para arroces, carnes, pescados, legumbres, verduras, guisos, cremas, salsas, sopas, etc.
- Revestimiento antiadherente Xylan Plus.
- Diseño atractivo y funcional.
- Compatibles con todo tipo de cocinas, incluida la inducción.

new

- Made in cast aluminium.
- It guarantees the absorption and uniform distribution of heat, without overheating points.
- The uniform distribution of heat throughout the product makes keep its juices during cooking, preserving all its nutrients and vitamins.
- The FULL INDUCTION diffuser bottom ensures optimal performance on all kinds of cookers with unbeatable heat distribution that achieves maximum efficiency and energy savings.
- Ideal product for: rice, meats, fish, beans, vegetables, stews, creams, sauces, soups, etc.
- Non-stick coating Xylan Plus.
- Attractive design and great functionality.
- It's compatible with all kinds of cookers, including induction.

# Batería MINI

new



- Fabricadas en aluminio fundido de máxima calidad.
- Ideal tanto para cocinar como para presentar aperitivos o platos.
- Antiadherente bicapa de alta calidad y 100% libre de PFOA.
- Libres de materiales tóxicos, pesados, disolventes y sustancias químicas.
- Diseñadas para una cocina saludable: permite cocinar sin apenas aceite garantizando que los alimentos no se peguen.
- Distribución homogénea del calor que permite una cocción rápida y uniforme.
- Aptas para todo tipo de fuegos: gas, eléctrica, vitrocerámica e inducción.
- Tapa fabricada en vidrio templado con válvula de salida de vapor. Pomo baquelita con acabado Soft Touch. Mango ergonómico con acabado Soft Touch.

- Fabriqué en fonte d'aluminium de la plus grande qualité.
- Idéale aussi bien pour cuisiner que pour la présentation d'apéritifs ou de plats.
- Finition antiadhésive bi-couche de grande qualité et 100% sans PFOA.
- Sans matériaux toxiques, métaux lourds, dissolvants et substances chimiques.
- Conçue pour une cuisine saine : permet de cuisiner sans à peine utiliser d'huile et avec la garantie que les aliments ne collent pas.
- Distribution homogène de la chaleur, ce qui permet une cuisson rapide et uniforme.
- Apte pour tous types de feux : gaz, électricité, vitrocéramique, four et induction.
- Couverture fabriqué en verre trempé avec valve à vapeur et poignée en bakélite avec finition Soft Touch. Manche ergonomique avec finition Soft Touch.

- Kasserolle aus einteiligem Aluminiumguss bester Qualität.
- Ideal zum Kochen und Anrichten von Vor- oder Hauptspeisen.
- Hochwertige zweilagige Antihaftbeschichtung ohne PFOA.
- Ohne Giftstoffe, Schwermetalle, Lösungsmittel und chemische Stoffe.
- Für eine gesunde Küche: Schon wenig Öl reicht aus und es bleibt garantiert nichts kleben.
- Gleichmäßige Wärmeverteilung sorgt für schnelle und einheitliche Ergebnisse.
- Für alle Herdarten geeignet: Gas, Elektro, Glaskeramik, Backofen und Induktion.
- Deckel aus Hartglas mit Dampfzug und Soft Touch-Knauf aus Bakelit.

- Made from a single piece of top quality cast aluminium.
- It's perfect for both cooking and presenting appetisers or dishes.
- It has a high quality bi-layer non-stick coating that is 100% PFOA free.
- It's free of toxic materials, heavy metals, solvents and chemical substances.
- It's designed for healthy cooking. It lets you cook with practically no oil and be sure that food won't stick.
- Food is cooked quickly and evenly because of the homogeneous heat distribution.
- It's suitable for all kinds of cookers: gas, electric, vitroceramic, oven and induction.
- The lid is made of tempered glass with a steam valve and has a bakelite handle with a Soft Touch finish. Ergonomic handle with a Soft Touch finish.

## Cacerola con tapa

Faitout avec couvercle  
Bratentopf mit Deckel  
Casserole with lid  
Caçarola com tampa



- Fabricadas em alumínio fundido de qualidade superior.
- Ideal para cozinhar e também para servir aperitivos ou pratos
- Acabamento antiaderente bi-capa de alta qualidade, 100% livre de PFOA.
- Não contém materiais tóxicos nem pesados, dissolventes e substâncias químicas.
- Pensada para uma cozinha saudável, permitem cozinhar praticamente sem azeite nem óleo, sem que os alimentos agarrem ao fundo.
- Distribuição homogénea do calor para uma cocção rápida e uniforme.
- Apta para todo o tipo de fogões: A gás, elétricos, placas de vitrocerâmica e de indução.
- Tapa fabricada em vidro temperado, com válvula de saída de vapor e pega de baquelite com acabamento Soft Touch. Cabo ergonómico com acabamento Soft Touch.

Ref	€	Ø (cm)	ØBase (cm)	h (mm)	e (mm)	L	U.Venta
25160	20,90	16	12,0	5,0	1,6	0,8	1

## Paellera

Plat à paella  
Pfanne  
Round dish  
Paelheira



## Sartén

Poêle  
Pfanne  
Frying pan  
Sertã



Ref	€	Ø (cm)	ØBase (cm)	h (mm)	e (mm)	L	U.Venta
25161	20,90	20	11,5	4,5	1,8	1,0	1

Ref	€	Ø (cm)	ØBase (cm)	h (mm)	e (mm)	U.Venta
25163	12,80	14	10,0	3,0	1,6	1

## Cazo recto

Casserole  
Stielkasserole, flach  
Saucepan  
Caçarola direita



## Grill

Grill  
Grill Induktionfähig  
Grill  
Grilhador



Ref	€	Ø (cm)	ØBase (cm)	h (mm)	e (mm)	L	U.Venta
25164	16,20	14	10,0	8,0	1,6	1,0	1

Ref	€	cm	ØBase (cm)	h (mm)	e (mm)	U.Venta
25162	14,10	14x14	10,0	2,5	1,6	1

# Colección SMALT



- Cacerola y paellera de hierro muy resistentes.
  - Cubiertas con una capa de esmalte vitrificado antiácido de máxima calidad.
  - Asas altamente reforzadas.
  - Perfectas para presentar y servir sabrosas tapas, raciones o pinchos.
- Faitout et poêle à paella en fer très résistantes.
  - Possèdent un revêtement avec une couche d'acier émaillé de la plus grande qualité.
  - Anses hautement renforcées.
  - Parfaites pour présenter et servir de savoureuses tapas, de petites portions ou des amuse-bouches.
- Sehr widerstandsfähige Bratentopf und Paellapfanne aus Eisen.
  - Mit emailierter Stahlbeschichtung von höchster Qualität.
  - Hochverstärkte Griffe.
  - Ideal zum Anrichten und Servieren von leckeren Tapas, Gerichten oder Snacks.
- Extremely strong metal casserole and paella dish.
  - Coated with a layer of top quality antacid vitrified enamel.
  - Heavily reinforced handles.
  - Perfect for serving or presenting delicious tapas, dishes or pinchos.
- Caçarola e paelheira de ferro muito resistentes.
  - Revestidas com uma capa de aço esmaltado da máxima qualidade.
  - Asas extra reforçadas.
  - Perfeitas para apresentar e servir saborosas tapas, rações ou aperitivos.

new



## Cacerola esmaltada

Faitout à paella  
Bratentopf, emailiert  
Casserole  
Caçarola esmaltada

Ref	€	Ø (cm)	h (cm)	U.Venta
60192	6,50	12	4,0	1
60196	7,70	16	4,5	1
60190	8,50	20	4,7	1

## Paellera esmaltada

Plat à paella  
Paellapfanne, emailiert  
Round dish for paella  
Paelheira esmaltada

Ref	€	Ø (cm)	U.Venta
60170	5,10	10	10
60172	5,70	12	10
60175	6,70	15	6
60180	8,60	20	6



# Batería MAGMA



**Hierro Fundido**  
Cast Iron

- Construida en una sola pieza.
  - Recubierta con una capa de aceite vegetal.
  - Ideal para cocinar, prolonga suavemente la cocción.
  - Gran conductor del calor, mantiene el calor mientras disfrutas y saboreas la comida.
  - Base de madera para servir y presentar la comida recién cocinada.
- Construite en une seule pièce.
  - Revêtu d'une couche d'huile végétale.
  - Idéal pour cuisiner, prolonge délicatement la cuisson.
  - Grand conducteur de chaleur, maintient le plat au chaud pendant que vous dégustez la nourriture.
  - Base en bois pour servir et présenter le plat fraîchement cuisiné.
- Aus einem Stück gefertigt.
  - Beschichtet mit einer Schicht von Pflanzenöl.
  - Ideal zum Kochen, verlängert den Kochvorgang auf sanfte Weise.
  - Hervorragender Wärmeleiter; erhält die Wärme während Sie die Speisen genießen.
  - Holzbasis, auf der das soeben zubereitete Gericht serviert und präsentiert wird.
- Built in one piece.
  - Coated with a layer of vegetable oil.
  - Ideal for cooking; gently continues to cook.
  - Great heat conductor; retains heat while you enjoy and savour the food.
  - Wooden base to serve and present freshly cooked food.
- Elementos fabricados a partir de uma única peça.
  - Revestidos com uma camada de óleo vegetal.
  - Ideal para cozinhar, prolonga suavemente a cocção.
  - Excelente condutor do calor, mantém o calor enquanto desfrutas da comida.
  - Base de madeira para servir e apresentar a comida recém-preparada.

## Cacerola con base

Faitout avec basse  
Bratentopf mit Holzsockel  
Casserola with base  
Caçarola com base



Ref	€	Ø (cm)	ml	U.Venta
25871	15,40	12,5	230	4
25872	21,00	16,2	470	1
25873	27,00	18,5	720	1

## Cacerola

Faitout  
Bratentopf  
Casserola  
Caçarola



Ref	€	Ø (cm)	ml	U.Venta
25771	10,70	12,5	230	4
25772	15,60	16,2	470	4
25773	18,80	18,5	720	1

## Cacerola oval con base

Faitout ovale avec basse  
Oval Bratentopf mit Holzsockel  
Oval casserola with base  
Caçarola oval com base



Ref	€	cm	ml	U.Venta
25881	15,60	15x10	200	4
25882	24,00	17,5x12,5	300	1
25883	26,70	21,7x15	700	1

## Cacerola oval

Faitout ovale  
Oval Bratentopf  
Oval casserola  
Caçarola oval



Ref	€	cm	ml	U.Venta
25781	12,10	15x10	200	4
25782	19,00	17,5x12,5	300	1
25783	21,60	21,7x15	700	1



### Mini plancha grill lisa rectangular con base

Mini plaque Grill lisse rectangulaire avec basse  
Mini Platte Grill, glatt, rechteckiger mit Holzsocket  
Mini rectangular grill plaque flat with base  
Mini plancha grill liso rectangular con base

Ref	€	cm	h (cm)	U.Venta
25874	15,00	17x10	2,5	4



### Mini plancha grill lisa rectangular

Mini plaque grill lisse rectangulaire  
Mini Platte Grill, glatt, rechteckiger  
Mini rectangular grill plaque flat  
Mini plancha grill liso rectangular

Ref	€	cm	h (cm)	U.Venta
25774	10,20	17x10	2,5	4



### Mini plancha grill cuadrado c/base

Mini plaque grill carré ave basse  
Mini Platte Grill, Quadrat mit Holzsocket  
Mini square grill plaque with base  
Mini plancha grill cuadrado com base

Ref	€	cm	h (cm)	U.Venta
25875	15,00	14x14	1,7	4



### Mini plancha grill cuadrado

Mini plaque grill carré  
Mini Platte Grill, Quadrat  
Mini square grill plaque  
Mini plancha grill cuadrado

Ref	€	cm	h (cm)	U.Venta
25775	10,70	14x14	1,7	4



### Mini grill con base

Mini grill avec basse  
Mini Grillmit Holzsocket  
Mini grill with base  
Mini grill com base

Ref	€	cm	h (cm)	U.Venta
25876	17,30	14x14	2,5	1



### Mini grill

Mini grill  
Mini Grill  
Mini grill  
Mini grill

Ref	€	cm	h (cm)	U.Venta
25776	11,10	14x14	2,5	4



### Mini sartén lisa c/base

Mini poêle lisse avec basse  
Mini Pfanne mit Holzsocket  
Mini frying pan flat with base  
Mini sertã lisa com base

Ref	€	Ø (cm)	h (cm)	U.Venta
25877	16,10	13	1,7	1



### Mini sartén lisa

Mini poêle lisse  
Mini Pfanne  
Mini frying pan flat  
Mini sertã lisa

Ref	€	Ø (cm)	h (cm)	U.Venta
25777	11,20	13	1,7	4

# Batería MAGMA GREY & RED



- Acabado exterior e interior esmaltado, muy resistente y de gran durabilidad.
- Muy versátil: ideal para cocinar asados, arroces, pasta, cocer a fuego lento e incluso hornear tartas dulces y pan.
- Conserva todos los nutrientes, vitaminas y sabores de los alimentos.
- Excelente retención y distribución uniforme del calor.
- Incluye base de madera, ideal para servir y presentar.
- Apta para todo tipo de fuegos.

- Finition extérieure et intérieure émaillée. Émail très résistant et d'une grande durabilité.
- Très versatile : idéale pour cuisiner des ragoûts, du riz, des pâtes, cuire à feu doux et même enfourner des gâteaux et du pain.
- Conserve tous les nutriments, les vitamines et les saveurs des aliments.
- Excellente rétention et distribution uniforme de la chaleur.
- Inclut une base en bois, idéale pour servir et présenter.
- Apte pour tous types de feux.

- Emaillierte Außen- und Innenflächen. Sehr beständige und langlebige Emaillierung.
- Sehr vielseitig: ideal zum Kochen, Braten und Garen, zum Bereiten von Nudeln und Reis und sogar zum Kuchen und Brot backen.
- Erhält Nährstoffe, Vitamine und Geschmack der Nahrungsmittel.
- Äußerst gleichmäßige Wärmeaufnahme und -verteilung.
- Inkl. Holzuntersatz -ideal zum Servieren und Anrichten.
- Für alle Herdarten geeignet.

- Enamel finish inside and outside. Very strong and durable enamel.
- Extremely versatile: perfect for roasts, rice, pasta, low heat cooking and even baking bread or cake.
- Preserves all the nutrients, vitamins and flavours of the food.
- Excellent heat retention and uniform heat distribution.
- Wooden base included, perfect for serving or presentation.
- Appropriate for all kinds of cookers.

- Acabamento exterior e interior esmaltado, muito resistente e de grande durabilidade.
- Grande versatilidade: ideal para cozinhar assados, arrozes, massas, cocção a fogo lento e inclusive para cozer no forno tartes doces e pão.
- Conserva todos os nutrientes, vitaminas e sabores dos alimentos.
- Excelente retenção e distribuição uniforme do calor.
- Inclui base de madeira, ideal para servir e apresentar.
- Apta para todo o tipo de fogões.

## Cacerola redonda GREY

Faitout rond  
Rund Bratentopf  
Round casserole  
Caçarola redonda



Ref	€	Ø (cm)	h (cm)	ml	U.Venta
25841	17,60	12,0	3,0	200	1
25848	27,30	16,2	3,0	470	1
25849	33,90	18,5	3,0	720	1

## Cacerola redonda RED

Faitout rond  
Rund Bratentopf  
Round casserole  
Caçarola redonda



Ref	€	Ø (cm)	h (cm)	ml	U.Venta
25851	17,60	12,0	3,0	200	1
25858	27,30	16,2	3,0	470	1
25859	33,90	18,5	3,0	720	1

## Cacerola oval GREY

Faitout ovale  
Oval Bratentopf  
Ocal casserole  
Caçarola oval



Ref	€	cm	h (cm)	ml	U.Venta
25842	23,50	17,5x12,5	3,0	250	1
25840	33,80	21,7x15	3,0	700	1

## Cacerola oval RED

Faitout ovale  
Oval Bratentopf  
Ocal casserole  
Caçarola oval



Ref	€	cm	h (cm)	ml	U.Venta
25852	23,70	17,5x12,5	3,0	250	1
25850	34,10	21,7x15	3,0	700	1

### Sartén GREY

Poêle  
Pfanne  
Frying pan  
Sertã



Ref	€	Ø (cm)	h (cm)	ml	U.Venta
25843	17,70	13,5	3,0	275	1

### Sartén RED

Poêle  
Pfanne  
Frying pan  
Sertã



Ref	€	Ø (cm)	h (cm)	ml	U.Venta
25853	17,70	13,5	3,0	275	1

### Cacerola rectang. c/tapa GREY

Faitout rectangulaire avec couvercle  
Bratentopf, rechteckig mit Deckel  
Rectangular casserole with lid  
Caçarola rectangular com tampa



Ref	€	cm	h (cm)	ml	U.Venta
25845	33,40	13x9	4,5	300	1

### Cacerola rectang. c/tapa RED

Faitout rectangulaire avec couvercle  
Bratentopf, rechteckig mit Deckel  
Rectangular casserole with lid  
Caçarola rectangular com tampa



Ref	€	cm	h (cm)	ml	U.Venta
25855	33,40	13x9	4,5	300	1

### Cacerola redonda c/tapa GREY

Faitout rond avec couvercle  
Rund Bratentopf mit Deckel  
Round casserole with lid  
Caçarola redonda com tampa



Ref	€	Ø (cm)	h (cm)	ml	U.Venta
25846	28,50	10	5,0	200	1

### Cacerola redonda c/tapa RED

Faitout rond avec couvercle  
Rund Bratentopf mit Deckel  
Round casserole with lid  
Caçarola redonda com tampa



Ref	€	Ø (cm)	h (cm)	ml	U.Venta
25856	28,50	10	5,0	200	1

### Cacerola oval c/tapa GREY

Faitout ovale avec couvercle  
Oval Bratentopf mit Deckel  
Oval casserole with lid  
Caçarola oval com tampa



Ref	€	cm	h (cm)	ml	U.Venta
25847	33,80	13x10	5,0	400	1

### Cacerola oval c/tapa RED

Faitout ovale avec couvercle  
Oval Bratentopf mit Deckel  
Oval casserole with lid  
Caçarola oval com tampa



Ref	€	cm	h (cm)	ml	U.Venta
25857	33,80	13x10	5,0	400	1

# Ollas a presión

Pressure cookers



# Olla a presión **CHEF-LUXE**

Inox  
18/10



Sandwich



Vitro



Electric



Gas



Induction



Oven  
Cuerpo/Body



Dishwasher  
Cuerpo/Body



- Sistema de apertura y cierre con una sola mano.
- Selección de posiciones (3 posiciones: 0 - I - II).
- Se puede utilizar como una cacerola normal.

- Ouverture et de fermeture d'une seule main.
- Sélection positions(3 positions: 0 - I - II).
- Peut être utilisé comme une casserole normale.

- Das Öffnen und Schließen mit einer Hand.
- Auswählen Stellungen (3 Position: 0 - I - II).
- Kann auch als normaler Topf verwendet werden.

- Opening and closing system with one hand.
- Selecting positions (3 position: 0 - I - II).
- Can be used as a normal casserole.

- Sistema de abertura e fechar com uma mão.
- A seleção de posições (3 posições: 0 - I - II).
- Pode ser usado como uma panela normais.

## Sistema de apertura y cierre con una sola mano

Opening and closing system with one hand



## Cuerpo olla a presión

Corps cocotte à pression  
Schnellkochtopf-Körper  
Pressure cooker stockpot  
Corpo panela de pressão

Ref	€	Ø (cm)	h (cm)	L	U.Venta
50816	203,90	32	18,0	15,0	1
50819	221,10	32	23,0	20,0	1
50824	251,80	32	32,0	23,0	1

## Tapa

Couvercle  
Deckel  
Lid  
Tampa



Ref	€	Ø (cm)	Año	U.Venta
50933	383,20	32	=<2015	1
50934	386,90	32	=>2015	1

## Tapa

Couvercle  
Deckel  
Lid  
Tampa



Ref	€	Ø (cm)	U.Venta
54932	27,80	32	1



## Olla a presión

Cocotte à pression  
Schnellkochtopf  
Pressure cooker  
Panela de pressão

Ref	€	Ø (cm)	h (cm)	L	U.Venta
50815	590,80	32	18,0	15,0	1
50818	608,00	32	23,0	20,0	1
50823	638,70	32	32,0	23,0	1

# Olla a presión **ROBUST**



**Gran durabilidad**  
High durability



## Olla a presión

Cocotte à pression  
Schnellkochtopf  
Pressure cooker  
Panela de pressão

Ref	€	Ø (cm)	h (cm)	L	U.Venta
20830	1.357,80	42	31	30	1
20840	1.447,90	42	39	40	1
20850	1.538,30	42	46	50	1



- Para uso profesional.
- Fabricada en aluminio de máxima calidad (grado de pureza 99,55%).
- Diseño elegante, selecto, de gran durabilidad.
- Triple sistema de seguridad.
- Ahorro de tiempo y energía (reduce los tiempos de cocción hasta un 70%).
- Puente más robusto y resistente. Asas de baquelita antiquemaduras.

· À usage professionnel.  
· Il est conçu en aluminium haute qualité (degré de pureté de 99,5 %).  
· Design élégant, sélect, d'une grande durabilité.  
· Triple système de sécurité.  
· Gain de temps et économie d'énergie (réduit les durées de cuisson jusqu'à 70%).  
· Pont plus robuste et résistant. Poignées en bakélite anti-brûlures.

· Für den gewerblichen Gebrauch.  
· Aus hochwertigem Aluminium (mit einem Reinheitsgrad von 99,5 %) gefertigt.  
· Elegantes, ausgesuchtes Design und äußerst robust.  
· Dreifaches Sicherheitssystem.  
· Zeit- und Energieersparnis (die Garzeiten werden um bis zu 70% reduziert).  
· Mehr robust und widerstandsfähig Brücke. Wärmeisolierte Bakelitgriffe.

· For professional use.  
· Made of high quality aluminium (with a 99.5% degree of purity).  
· Elegant, exclusive and highly durable design.  
· Triple safety system.  
· Time and energy saving (Reduces cooking times by up to 70%).  
· The safety - pressure release valve is activated if the pressure valve fails.  
· More robust and resistant bridge.

· Para uso profissional.  
· Fabricada em alumínio da máxima qualidade, (grau de pureza é de 99,5 %).  
· Design elegante e exclusivo, de grande durabilidade.  
· Triplo sistema de segurança.  
· Poupa tempo e energia (reduz os tempos de cocção até 70%).  
· Ponte mais robusto e resistente. Asas de baquelite anti-queimaduras.

# Olla a presión **PRO-CLASSIC**



**Fabricada en aluminio puro**  
Manufactured in pure aluminium



## Olla a presión

Cocotte à pression  
Schnellkochtopf  
Pressure cooker  
Panela de pressão

Ref	€	Ø (cm)	h (cm)	L	U.Venta
20511	111,50	28	22	11,0	1
20515	128,20	30	25	15,0	1
20518	159,50	32	23	18,0	1
20522	177,30	34	23	22,0	1
20533	211,90	36	32	33,0	1



- Para uso profesional.
- Válvula de presión/contrapeso, permite que se libere el vapor regulando la presión interior de la olla.
- Válvula de seguridad - despresurización, actúa si la válvula de presión falla.
- Puente más robusto y resistente. Asas de baquelita antiquemaduras.

· À usage professionnel.  
· Soupape à pression/contrepois, permet de libérer la vapeur en régulant la pression intérieure de l'autocuiseur.  
· Soupape de sécurité - dépressurisation, agit dans le cas d'un dysfonctionnement de la soupape à pression.  
· Pont plus robuste et résistant. Poignées en bakélite anti-brûlures.

· Für den gewerblichen Gebrauch.  
· Druckventil/Ausgleichsventil: Regelt den Innendruck, indem Dampf nach außen geleitet werden kann.  
· Sicherheitsventil: Führt den Druckausgleich aus, wenn das Druckventil versagt.  
· Mehr robust und widerstandsfähig Brücke. Wärmeisolierte Bakelitgriffe.

· For professional use.  
· The pressure/counterweight valve lets steam escape and regulates pressure inside the pot.  
· The safety - pressure release valve is activated if the pressure valve fails.  
· More robust and resistant bridge. Anti-scald Bakelite Handles.

· Para uso profissional.  
· Válvula de pressão/contrapeso, que permite a libertação do vapor regulando a pressão interior da panela.  
· Válvula de segurança - despresurização, atua em caso de falha da válvula de pressão.  
· Ponte mais robusto e resistente. Asas de baquelite anti-queimaduras.

# Olla a presión **CLASSIC**



**Válvula de seguridad**  
Safety valve



- Fabricada en acero inoxidable 18/10 de máxima calidad.
- Marcaje interior, grabado con la capacidad del uso de la olla.
- Asas de baquelita antiquemaduras. Válvula de seguridad.
- Apta para todo tipo de cocinas. Triple fondo FULL INDUCTION para una distribución rápida y homogénea del calor.
- \* Las referencias 71872-71875 contienen un cestillo.

- Fabrication en acier inoxydable 18/10 de qualité maximale.
- Marquage intérieur, marquage gravé de la capacité d'utilisation de l'autocuiseur.
- Poignées en bakélite anti-brûlures. Soupape de sécurité.
- Apte pour tout type de feux. Triple fond FULL INDUCTION pour une distribution rapide et homogène de la chaleur.
- \* Les références 71872-71875 contiennent un panier.

- Materia, Edelstahl 18/10 bester Qualität mit Hochglanzschliff an der Außenseite.
- Innenmarkierung, füllstandsanzeige mit Min-Max-Gravierung.
- Wärmeisolierte Bakelitgriffe. Sicherheitsventil.
- Für alle möglichen Kochstellen geeignet. Dreifacher Boden FULL INDUCTION für eine schnelle und gleichförmige Hitzeverteilung.
- \* In den Artikeln 71872-71875 ist ein Korb im Lieferumfang enthalten.

- Manufactured in high-quality 18/10 stainless steel.
- Inner marking, engraved with the cooker's capacity.
- Burn-resistant Bakelite handles Safety valve.
- Suitable for any type of hob. Tri-ply FULL INDUCTION base for quick, even heat distribution.
- \* The 71872-71875 references contain a basket.

- Fabricada em aço inoxidável 18/10 da máxima qualidade.
- Marcação interior, gravação com a capacidade de uso da panela.
- Asas de baquelite anti-queimaduras. Válvula de segurança.
- Utilizável com todo o tipo de fogões. Fundo triplo FULL INDUCTION para uma distribuição rápida e homogénea do calor.
- \* As referências 71872-71875 incluem um cesto.

## Olla a presión

Cocotte à pression  
Schnellkochtopf  
Pressure cooker  
Panela de pressão

Ref	€	Ø (cm)	h (cm)	L	U.Venta
71874	86,60	22	11,5	4,0	1
71876	95,00	22	17,0	6,0	1
71878	103,90	24	19,0	8,0	1
71871	113,20	24	23,0	10,0	1
71872	178,60	26	23,0	12,0	1 *
71875	192,30	26	29,0	15,0	1 *

**Marcaje interior**  
Inner marking

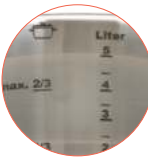

# Olla a presión **SICURO**

new



**Sistema de apertura y cierre con una sola mano**  
One-handed opening and closing mechanism



**Nivel de cocción: 0 y 100kpa**  
Cooking level



- Fabricada en acero inoxidable 18/10 de máxima calidad con acabado satinado.
- Fondo termodifusor sándwich; distribución rápida y uniforme del calor.
- Marcaje interior en litros.
- Asas termorresistentes que aseguran un manejo cómodo y seguro.
- Ahorra un 70% de energía conservando el aroma y sabor de los alimentos.
- Nivel de cocción totalmente ajustable: gira el pomo y elige la presión entre 0 y 100kpa.
- Cierre fácil y 100% seguro: sistema de apertura y cierre con una sola mano.
- Triple sistema de seguridad:
  - \* Válvula de seguridad: actúa en caso de aumento excesivo de presión, despresurizando rápidamente la olla.
  - \* Sistema de bloqueo de seguridad: imposibilidad de apertura de la tapa mientras cocinamos.
  - \* Ventana lateral de seguridad.
- Compatible con todas las fuentes de calor, incluida la inducción. Cuerpo apto para el lavavajillas.

- Made of top quality 18/10 stainless steel with satin finish.
- Sandwich thermo-diffuser bottom for fast, even heat distribution.
- Graduated litre marks inside.
- Heat-resistant handles for comfortable, safe grip.
- Saves 70% energy whilst still retaining the aroma and flavour of the food.
- Fully adjustable cooking level: turn the knob to select the pressure setting from 0 to 100 kPa.
- Simple, 100% safe one-handed opening and closing mechanism.
- Triple safety system:
  - \* Safety valve, which opens in the event of excessive pressure and quickly depressurises the cooker.
  - \* Safety locking system, preventing the lid from being opened while cooking is in progress.
  - \* Safety pressure relief opening on the side.
- Compatible with all heat sources, including induction. Dishwasher safe body.

## Olla a presión

Cocotte à pression  
Schnellkochtopf  
Pressure cooker  
Panela de pressão

Ref	€	Ø (cm)	h (cm)	L	U.Venta
71874	199,20	22	11,0	4,0	1
71876	205,10	22	16,0	6,0	1
71878	215,60	22	21,1	8,0	1

**Fondo termodifusor**  
Thermo-diffuser bottom





# Olla a presión MASTER



## Niveles de cocción Cooking levels

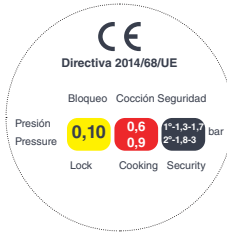

- Fabricada en acero inoxidable 18/10 de máxima calidad.
- Marcaje interior, grabado con la capacidad del uso de la olla.
- Visualizador de los niveles de cocción mediante anillas de colores.
- 2 niveles de cocción: 1.- Rápida (verduras, hortalizas y pescados).  
2.- Superrápida (carnes y estofados).
- Válv. de seguridad · Sist. de bloqueo de seguridad · Ventanas laterales de seguridad.
- Apta para todo tipo de cocinas. Fondo FULL INDUCTION.

- Fabrication en acier inoxydable 18/10 de qualité maximale.
- Marquage intérieur, marquage gravé de la capacité d'utilisation de l'autocuiseur.
- Visualisateur des niveaux de cuisson via anneaux de couleur.
- 2 niveaux de cuisson : 1.- Rapide (légumes et les poissons).  
2.- Super rapide (viandes et les ragoûts).
- Soupape de sécurité · Syst. de blocage de sécurité · Fenêtres latérales de sécurité.
- Apte pour tout type de feux. Fond FULL INDUCTION.

- Materia, Edelstahl 18/10 bester Qualität.
- Innenmarkierung, füllstandsanzeige mit Min-Max-Gravierung.
- Anzeige der Garstufen mittels farbigen Ringmarkierungen.
- 2 Garstufen: 1.- Schnelle (Feld- und Gartengemüse sowie Fisch).  
2.- Sehr schnelle (Speisen wie Fleischgerichte).
- Sicherheitsventil · Deckelverriegelung · Seitliche Sicherheitsfenster.
- Für alle möglichen Kochstellen geeignet. Boden FULL INDUCTION.

- Manufactured in high-quality 18/10 stainless steel.
- Inner marking, engraved with the cooker's capacity.
- Cooking level indicator-display using coloured rings.
- 2 cooking levels: 1.- Fast (vegetables and fish).  
2.- Super-fast (meats and stews).
- Safety valve · Safety locking system · Side safety windows.
- Suitable for any type of hob. FULL INDUCTION base.

- Fabricada em aço inoxidável 18/10 da máxima qualidade.
- Marcação interior, gravação com a capacidade de uso da panela.
- Visualizador dos níveis de cocção com anéis de cor.
- 2 níveis de cocção: 1.- Rápida (verduras, hortaliças e peixes).  
2.- Super rápida (carnes e estofados).
- Válv. de segurança · Sist. de bloqueio de segurança · Janelas laterais de segurança.
- Utilizável com todo o tipo de fogões. Fundo FULL INDUCTION.

## Olla a presión

Cocotte à pression  
Schnellkochtopf  
Pressure cooker  
Panela de pressão

Ref	€	Ø (cm)	h (cm)	L	U.Venta
71884	79,30	22	15,5	4,0	1
71886	86,10	22	22,0	6,0	1
71887	103,80	24	23,5	8,0	1

## Marcaje interior Inner marking

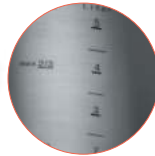

# Olla a presión TEMPO



## Niveles de cocción Cooking levels



- Fabricada en acero inoxidable 18/10 de máxima calidad.
- Marcaje interior, grabado con la capacidad del uso de la olla.
- Válvula de control para seleccionar el nivel de presión.
- Niveles de cocción: cocción lenta y cocción rápida.
- Válvula de seguridad · Sistema de bloqueo de seguridad · Ventanas laterales de seguridad.
- Apta para todo tipo de cocinas. Triple fondo FULL INDUCTION para una distribución rápida y homogénea del calor.

- Manufactured in high-quality 18/10 stainless steel.
- Inner marking, engraved with the cooker's capacity.
- Control valve for selecting the power level.
- Cooking levels: slow cooking and fast cooking.
- Safety valve · Safety locking system · Side safety windows.
- Suitable for any type of hob. Tri-ply FULL INDUCTION base for quick, even heat distribution.

## Olla a presión

Cocotte à pression  
Schnellkochtopf  
Pressure cooker  
Panela de pressão

Ref	€	Ø (cm)	h (cm)	L	U.Venta
71864	87,20	22	15,0	4,0	1
71866	89,70	22	23,0	6,0	1
71868	96,30	22	27,0	8,0	1

## Marcaje interior Inner marking



## Set de ollas a presión

Ensemble de cocottes à pression  
Schnellkochtopf-Satz  
Set of pressure cooker  
Conj. de panelas de pressão

Ref	€	Ø (cm)	h (cm)	L	U.Venta
71862	136,80	22	16,0	6,0	1
		22	12,0	4,0	





# Sartenes

Frypans

# Sartenes CHEF-INOX

Inox  
18/10



Sandwich



Vitro



Electric



Gas



Induction



Oven



Dishwasher



- Fabricadas en acero inoxidable 18/10 de la mejor calidad.
- Máxima garantía en resistencia, durabilidad e higiene.
- Acabado interior y exterior lijado satinado.
- Fondo termodifusor sándwich, distribución rápida y uniforme del calor.
- Homogeneidad y eficacia térmica. Cocción ultrarrápida.
- Aptas para todos los fuegos.

- Fabriquéés en acier inoxydable 18/10 de la meilleure qualité.
- Garantie maximale de résistance, de durabilité et d'hygiène.
- Finition interne et externe en brossage satiné.
- Fond thermo-diffuseur sandwich, distribution rapide et uniforme de la chaleur.
- Homogénéité et efficacité thermique. Cuisson ultra-rapide.
- Aptes pour tous les feux.

- Aus Edelstahl 18/10 bester Qualität.
- Garantiert robust, langlebig und hygienisch.
- Außen- und Innenseite in mattem Schliff.
- Wärmeleitender Sandwichboden, schnelle und gleichmäßige Wärmeverteilung.
- Gleichförmigkeit und thermische Effektivität. Ultraschnelles Garen.
- Für alle Herdarten geeignet.

- Made of 18/10 stainless steel of the best quality.
- Maximum guarantee in resistance, durability and hygiene.
- Glossy sanded interior and exterior finish.
- Heat-diffusing sandwiched base, quick and even heat distribution.
- Thermal homogeneity and efficiency. Ultra-rapid cooking.
- Suitable for all types of cookers.

- Fabricadas em aço inoxidável 18/10 da melhor qualidade.
- Máxima garantia de resistência, durabilidade e higiene.
- Acabamento interior e exterior acetinado.
- Fundo termodifusor tipo sanduiche, que assegura uma distribuição rápida e uniforme do calor.
- Homogeneidade e eficácia térmica. Cocção ultra-rápida.
- Aptas para todos os fogões.



## Sartén CHEF-INOX

Poêle  
Pfanne  
Frying-pan  
Sertã

Ref	€	Ø (cm)	h (cm)	e (mm)	U.Venta
51620	40,90	20	4,0	1,0	1
51624	45,20	24	4,5	1,0	1
51628	54,70	28	5,5	1,0	1
51632	65,50	32	6,0	1,0	1
51636	82,20	36	6,5	1,0	1
51640	98,30	40	6,5	1,0	1



Antiadherente · Non-stick  
ECLIPSE PLUS



## Sartén CHEF-INOX PLUS

Poêle  
Pfanne  
Frying-pan  
Sertã

Ref	€	Ø (cm)	h (cm)	e (mm)	U.Venta
51621	50,20	20	4,0	1,0	1
51625	56,30	24	4,5	1,0	1
51629	67,80	28	5,5	1,0	1
51633	84,20	32	6,0	1,0	1
51637	109,10	36	6,5	1,0	1
51641	127,20	40	6,5	1,0	1



Acabado cerámico  
Ceramic finished



## Sartén CHEF-INOX CERAM

Poêle  
Pfanne  
Frying-pan  
Sertã

Ref	€	Ø (cm)	h (cm)	e (mm)	U.Venta
51720	51,90	20	4,0	1,0	1
51724	58,90	24	4,5	1,0	1
51728	71,10	28	5,5	1,0	1
51732	88,80	32	6,0	1,0	1
51736	110,00	36	6,5	1,0	1
51740	128,90	40	6,5	1,0	1

# Sartenes ALUMINIO



## Sartén CHEF-TRICAPA

Poêle  
Pfanne  
Frying pan  
Sertã



- Sartenes fabricadas en aluminio de máxima calidad diseñadas para uso profesional.
- Óptima distribución del calor conservando las propiedades nutritivas de los alimentos, con un mínimo gasto de aceite y energía.
- Recubrimiento antiadherente.
- Ecológico, libre de materiales tóxicos y pesados. Libre de PFOA.
- Ideales para un uso continuo. Ligeras, ergonómicas y fáciles de limpiar.
- Aptas para todo tipo de cocinas, excepto inducción.

Ref	€	Ø (cm)	h (cm)	e (mm)	U.Venta
21618	26,30	18	3,8	2,5	6
21620	28,80	20	4,0	3,5	6
21622	31,50	22	4,0	3,5	6
21624	34,80	24	4,5	3,5	6
21626	38,50	26	4,5	4,0	6
21628	43,80	28	4,5	4,0	6
21632	51,70	32	4,7	4,0	6
21636	61,60	36	5,5	4,0	4
21640	71,40	40	5,5	4,0	4

- Poêles fabriquées en aluminium de grande qualité conçues pour un usage professionnel.
- Distribution optimale de la chaleur en conservant les propriétés nutritives des aliments, avec une utilisation d'huile et d'énergie minimales.
- Revêtement antiadhésif.
- Écologique, exempt de matériaux toxiques et lourds. Sans PFOA.
- Idéales pour un usage continu. Légères, ergonomiques et faciles à nettoyer.
- Compatible tous feux sauf induction, excepté induction.

- Pans made in top quality aluminium and design for professional use.
- Optimal heat distribution, preserving the nutritional properties, with a minimal waste of oil and energy.
- Non-stick coating.
- Ecological, free of toxic and heavy materials. PFOA free.
- Ideal for continuous use. Light, ergonomic and easy to clean.
- Suitable for all types of cooking surfaces, except induction.

new



## Sartén DYNAMIC

Poêle  
Pfanne  
Frying-pan  
Sertã



## Sartén honda CHEF-TRICAPA

Poêle profonde  
Tiefe Pfanne  
Deep frying-pan  
Sertã funda

Ref	€	ØD (cm)	Ød (cm)	h (cm)	e (mm)	U.Venta
21524	53,20	24	18,5	6,5	3,5	1
21528	65,80	28	22,0	6,5	4,0	1

Ref	€	Ø (cm)	h (cm)	e (mm)	U.Venta
23416	14,80	16	3,5	2,5	6
23418	16,00	18	3,5	2,5	6
* 23420	19,00	20	4,0	3,5	6
* 23422	22,30	22	4,0	3,5	6
* 23424	24,70	24	4,5	3,5	6
* 23426	29,50	26	4,5	4,0	6
* 23428	31,90	28	4,5	4,0	6
* 23432	38,50	32	4,7	4,0	6
23436	49,60	36	5,5	4,0	4

- \* Compatible con nuestro mango de silicona (Ref.: 23900)  
Compatible with our silicone handle (Ref.: 23900)



## Sartén con fondo TRICAPA PLUS

Poêle avec fond  
Pfanne mit Boden  
Frying-pan with bottom  
Sertã com fundo

Ref	€	Ø (cm)	h (cm)	e (mm)	U.Venta
* 21718	29,10	18	3,8	2,5	6
* 21720	33,10	20	4,0	3,5	6
* 21722	35,00	22	4,0	3,5	6
* 21724	38,80	24	4,5	3,5	6
* 21726	45,20	26	4,5	4,0	6
* 21728	48,60	28	4,5	4,0	6
* 21732	56,40	32	4,7	4,0	6
21736	68,90	36	5,5	4,0	4

- \* Compatible con nuestro mango de silicona (Ref.: 23900)  
Compatible with our silicone handle (Ref.: 23900)



## Sartén c/fondo ECO-CHEF

Poêle avec fond  
Pfanne mit Boden  
Frying-pan with bottom  
Sertã com fundo



Acabado cerámico  
Ceramic finished

Ref	€	Ø (cm)	h (cm)	e (mm)	U.Venta
22718	31,30	18	3,8	2,5	6
22720	35,50	20	4,0	3,5	6
22722	38,80	22	4,0	3,5	6
22724	41,40	24	4,5	3,5	6
22726	48,00	26	4,5	4,0	6
22728	52,30	28	4,5	4,0	6
22732	61,30	32	4,7	4,0	6
22736	72,20	36	5,5	4,0	4

# Colección **ROBUST**



- Sartenes fabricadas en aluminio de máxima calidad diseñadas para uso profesional.
- Óptima distribución de calor conservando las propiedades nutritivas de los alimentos y con un mínimo gasto de aceite y energía.
- Recubrimiento antiadherente multicapa (5 capas) ecológico y libre de PFOA.
- Ideales para un uso continuo. Ligeras, manejables y fáciles de limpiar gracias a su antiadherente exterior. Aptas para todo tipo de cocinas, excepto inducción.

- Poêles fabriquées en aluminium de grande qualité conçues pour un usage professionnel.
- Distribution optimale de la chaleur en conservant les propriétés nutritives des aliments et avec une utilisation d'huile et d'énergie minimales.
- Revêtement antiadhésif multicouches (5 couches) écologique et sans PFOA.
- Idéales pour un usage continu. Légères, maniables et faciles à nettoyer grâce à leur revêtement antiadhésif extérieur. Compatibles avec tout type de cuisinière, excepté l'induction.

- Pfannen aus qualitativem Aluminium für professionellen Gebrauch.
- Optimale Wärmeverteilung bewahrt Nährwert der Speisen und verbraucht wenig Energie und Öl.
- Umweltfreundliche mehrlagige Antihafbeschichtung (5 Lagen) ohne PFOA.
- Ideal für dauernden Einsatz. Leicht, handlich und einfach zu reinigen dank Antihafbeschichtung an der Außenseite. Für alle Herdarten mit Ausnahme von Induktion geeignet.

- Pans made in top quality aluminium and design for professional use.
- Optimal heat distribution, preserving the nutritional properties and with a minimal waste of oil and energy.
- Multi-layer (5 layers) eco-friendly non-stick coating, PFOA-free.
- Ideal for continuous use. Light, easy handling and easy to clean due to its nonstick exterior. Suitable for all types of cooking surfaces, except induction.

- Sertãs fabricadas em alumínio da máxima qualidade, pensadas para uso profissional.
- Ótima distribuição do calor, conservando as propriedades nutritivas dos alimentos, e reduzindo ao mínimo o gasto de óleo e de energia.
- Revestimento antiaderente Multicapa ( 5 capas), ecológico e sem PFOA.
- Ideais para um uso contínuo. Leves, fáceis de manipular e de limpar, graças ao seu revestimento exterior antiaderente. Aptas para todo o tipo de fogões (exceto placas de indução).

## Sartén

Poêle  
Pfanne  
Frying-pan  
Sertã



Ref	€	Ø (cm)	h (cm)	e (mm)	U.Venta
23616	14,80	16	3,5	2,5	6
23618	16,00	18	3,5	2,5	6
* 23620	19,00	20	4,0	3,5	6
* 23622	22,30	22	4,0	3,5	6
* 23624	24,40	24	4,5	3,5	6
* 23626	29,50	26	4,5	4,0	6
* 23628	31,60	28	4,5	4,0	6
* 23632	38,10	32	4,7	4,0	6
23636	49,60	36	5,5	4,0	4
23640	58,20	40	5,5	4,0	4

\* Compatible con nuestro mango de silicona (Ref.: 23900)  
Compatible with our silicone handle (Ref.: 23900)

## Sartén ROBUST PLUS

Poêle  
Pfanne  
Frying-pan  
Sertã



Ref	€	Ø (cm)	h (cm)	e (mm)	U.Venta
23816	16,60	16	3,5	2,5	6
23818	17,70	18	3,5	2,5	6
23820	21,40	20	4,0	3,5	6
23822	24,10	22	4,0	3,5	6
23824	26,80	24	4,5	3,5	6
23826	31,00	26	4,5	4,0	6
23828	36,10	28	4,5	4,0	6
23832	41,90	32	4,7	4,0	6
23836	51,40	36	5,5	4,0	4
23840	62,10	40	5,5	4,0	4

new



### Sartén honda

Poêle profonde  
Tiefe Pfanne  
Deep frying-pan  
Sertã funda

Ref	€	ØD (cm)	Ød (cm)	h (cm)	e (mm)	U.Venta
* 23625	41,80	24	18,5	6,5	3,5	1
* 23629	47,50	28	22,0	6,5	4,0	1

\* Compatible con nuestro mango de silicona (Ref.: 23900)  
Compatible with our silicone handle (Ref.: 23900)



### Sartén Blinis

Poêle Blinis  
Pfanne Blinis  
Frying-pan Blinis  
Sertã Blinis

Ref	€	Ø (cm)	h (cm)	e (mm)	U.Venta
23612	11,40	12	2,1	2,5	6
23614	13,40	14	2,2	2,5	6

### Wok

Wok  
Wok  
Wok  
Wok



Ref	€	Ø (cm)	h (cm)	e (mm)	U.Venta
* 23830	43,80	30	7,0	4,0	1

\* Compatible con nuestro mango de silicona (Ref.: 23900)  
Compatible with our silicone handle (Ref.: 23900)

### Crepera

Crêpiere  
Crêpes Pfanne  
Crepiera  
Crepeira



Ref	€	Ø (cm)	h (cm)	e (mm)	U.Venta
* 23322	18,00	22	1,8	2,5	1
* 23326	22,70	26	1,8	2,7	1
* 23330	32,80	30	2,2	4,0	1

\* Compatible con nuestro mango de silicona (Ref.: 23900)  
Compatible with our silicone handle (Ref.: 23900)

### Sartén oval

Poêle ova  
Pfanne, oval  
Oval frying-pan  
Sertã oval



Ref	€	cm	h (cm)	e (mm)	U.Venta
23637	63,70	36x26	5,0	2,7	1
23641	66,30	40x29	5,5	2,7	1

### Sartén rectangular

Poêle rectangulière  
Pfanne, rechteckig  
Rectangular frying-pan  
Sertã rectangular



Ref	€	cm	h (cm)	e (mm)	U.Venta
* 23638	55,70	38x26	5,0	4,0	1

\* Compatible con nuestro mango de silicona (Ref.: 23900)  
Compatible with our silicone handle (Ref.: 23900)

# Colección FERRUM



- Disfruta de una sartén para toda la vida.
- Fabricadas artesanalmente con 100% hierro natural.
- Calidad Premium; duraderas y resistentes a arañazos.
- Alta conductividad térmica. El hierro al ser un excelente conductor del calor, permite conseguir y mantener la temperatura ideal de cocción con un menor consumo energético.
- Espesor 2,5 mm. Fácil limpieza. Cocina ecológica, cocina saludable.
- Antiadherente premium, libre de PFOA (sartén antiadherente).

- Une poêle qui vous durera toute la vie.
- Fabriquées de façon artisanale avec 100% de métal naturel.
- Qualité Premium; durables et résistantes aux rayures.
- Haute conductivité thermique. Le métal, excellent conducteur de chaleur, permet d'obtenir et de maintenir la température de cuisson idéale avec une consommation d'énergie moins importante.
- Épaisseur 2,5mm. Nettoyage facile. Cuisine écologique, cuisine saine.
- Antiadhésif premium, sans PFOA (Poêle antiadherent).

- Eine Pfanne an der Sie lebenslang Freude haben.
- Von Hand aus 100% natürlichem Eisen hergestellt.
- Premiumqualität - langlebig und kratzfest.
- Hohe Wärmeleitfähigkeit Sehr stark wärmeleitendes Eisen sorgt für anhaltend ideale Kochtemperatur bei geringerem Energieverbrauch.
- 2,5 mm dick. Einfach zu reinigen. Umweltfreundliche und gesunde Küche.
- Antihaft Premium ohne PFAO (Eisen-Pfanne, Antihafit).

- Enjoy this one pan your whole life.
- Hand-made in 100% natural iron.
- Premium Quality; long lasting and resistant to scratching.
- High heat conduction. Iron is an excellent conductor of heat, allowing you to obtain and maintain the ideal temperature with less energy consumption
- 2.5mm thickness. Easy to clean. Eco-friendly, healthy kitchen.
- Premium Quality; long lasting and resistant to scratching (Non-stick frying-pan).

- Desfrute de uma sertã para toda a vida.
- Fabricadas artesanalmente, 100% ferro natural.
- Qualidade Premium, de longa duração e resistentes aos riscos.
- Alta condutividade térmica. Ao ser um excelente condutor do calor, o ferro permite alcançar e manter a temperatura ideal de cocção com um menor consumo energético.
- Espessura de 2,5 mm. Fácil limpeza. Cozinha ecológica, cozinha saudável energético.
- Antiaderente Premium, sem PFOA (sertã anti-aderente).



## Sartén

Poêle  
Pfanne  
Frying-pan  
Sertã

Ref	€	Ø (cm)	h (cm)	e (mm)	U.Venta
* 63620	30,00	20	3,5	2,5	1
* 63624	34,60	24	4,5	2,5	1
* 63626	37,30	26	4,5	2,5	1
* 63628	39,30	28	5,0	2,5	1
* 63632	47,10	32	5,3	2,5	1
63636	60,00	36	5,5	2,5	1
63640	66,50	40	5,8	2,5	1

\* Compatible con nuestro mango de silicona (Ref.: 23900)  
Compatible with our silicone handle (Ref.: 23900)



## Sartén antiadherente

Poêle antiadherent  
Pfanne, Antihafit  
Frying-pan, non-stick  
Sertã anti-aderente

Ref	€	Ø (cm)	h (cm)	e (mm)	U.Venta
* 63720	33,90	20	3,5	2,5	1
* 63724	37,30	24	4,5	2,5	1
* 63726	39,90	26	4,5	2,5	1
* 63728	42,20	28	5,0	2,5	1
* 63732	49,60	32	5,3	2,5	1
63736	62,70	36	5,5	2,5	1
63740	72,50	40	5,8	2,5	1

\* Compatible con nuestro mango de silicona (Ref.: 23900)  
Compatible with our silicone handle (Ref.: 23900)

## Sartén honda

Poêle profonde  
Tiefe Pfanne  
Deep frying-pan  
Sertã funda



Ref	€	Ø (cm)	h (cm)	e (mm)	U.Venta
* 63424	50,20	24	7,0	2,5	1
* 63428	58,10	28	8,0	2,5	1
* 63432	85,80	32	8,8	2,5	1

Con asa · With handle

\* Compatible con nuestro mango de silicona (Ref.: 23900)  
Compatible with our silicone handle (Ref.: 23900)

## Cazo bombado

Casserole bombée  
Kasserolle, Bauchig  
Rounded saucepan  
Çaçarola bojuda



Ref	€	Ø (cm)	h (cm)	e (mm)	U.Venta
* 63419	46,20	20	10	2,5	1
* 63423	58,10	24	12	2,5	1

\* Compatible con nuestro mango de silicona (Ref.: 23900)  
Compatible with our silicone handle (Ref.: 23900)

## Sartén Blinis

Poêle Blinis  
Blinis Pfanne  
Blinis frying pan  
Sertã Blinis



Ref	€	Ø (cm)	h (cm)	e (mm)	U.Venta
63613	25,00	12	2,1	2,0	6
63614	28,00	14	2,2	2,0	6

## Sartén Blinis antiadherente

Poêle Blinis antiadherent  
Blinis Pfanne, Antihaft  
Blinis frying pan, Non-stick  
Sertã Blinis anti-aderente



Ref	€	Ø (cm)	h (cm)	e (mm)	U.Venta
63712	26,40	12	2,1	2,0	6
63714	29,10	14	2,2	2,0	6



## Asador

Rôtissoire  
Grill  
Rotisserie  
Grelhador



Ref	€	Ø (cm)	h (cm)	e (mm)	U.Venta
* 63725	37,30	26	3,0	2,5	1

\* Compatible con nuestro mango de silicona (Ref.: 23900)  
Compatible with our silicone handle (Ref.: 23900)

## Asador antiadherente

Rôtissoire, antiadherent  
Grill, Antihaft  
Non-stick rotisserie  
Grelhador anti-aderente



Ref	€	Ø (cm)	h (cm)	e (mm)	U.Venta
* 63727	38,40	26	3,0	2,5	1

\* Compatible con nuestro mango de silicona (Ref.: 23900)  
Compatible with our silicone handle (Ref.: 23900)

Asas de acero inoxidable  
Stainless steel handles

## Paellera

Plat à paella  
Paellapfanne  
Round dish for paella  
Paelheira



Ref	€	Ø (cm)	h (cm)	e (mm)	Raciones	U.Venta
63928	57,10	28	4,5	2,5	3	1
63932	64,70	32	4,7	2,5	5	1
63936	80,70	36	5,5	2,5	7	1
63940	88,90	40	5,5	2,5	9	1



Asas de acero Inoxidable  
Stainless steel handles



### Plancha Grill lisa

Plaque à Grill lisse  
Platte Grill, glatt  
Grill flat plaque  
Plancha Grill lisa

Ref	€	cm	h (cm)	e (mm)	U.Venta
63642	69,20	37 x 27	5,0	2,5	1

Asas de acero Inoxidable  
Stainless steel handles



### Plancha Grill

Plaque à Grill  
Platte Grill  
Grill plaque  
Plancha Grill

Ref	€	cm	h (cm)	e (mm)	U.Venta
63644	73,50	37 x 27	5,0	2,5	1



### Wok

Wok  
Wok  
Wok  
Wok

Ref	€	Ø (cm)	h (cm)	e (mm)	U.Venta
* 63828	48,40	28	8,0	2,0	1

\* Compatible con nuestro mango de silicona (Ref.: 23900)  
Compatible with our silicone handle (Ref.: 23900)



### Wok antiadherente

Wok, Antiadherent  
Wok, Antihalt  
Wok, non-stick  
Wok anti-aderente

Ref	€	Ø (cm)	h (cm)	e (mm)	U.Venta
* 63829	50,40	28	8,0	2,0	1

\* Compatible con nuestro mango de silicona (Ref.: 23900)  
Compatible with our silicone handle (Ref.: 23900)



### Crepera antiadherente

Crêpière, antiadherent  
Crêpes-Pfanne, Antihalt  
Crepiere, Non-stick  
Crepeira anti-aderente

Ref	€	Ø (cm)	h (cm)	e (mm)	U.Venta
* 23323	27,20	22	1,8	2,5	1
* 23327	31,10	26	2,2	2,5	1

\* Compatible con nuestro mango de silicona (Ref.: 23900)  
Compatible with our silicone handle (Ref.: 23900)



### Wok antiadherente

Wok, Antiadherent  
Wok, Antihalt  
Wok, Non-stick  
Wok anti-aderente

Ref	€	Ø (cm)	h (cm)	e (mm)	U.Venta
63729	35,80	28	8,5	0,9	1

# Accesorios



## Protector de silicona

Protection en silicone  
Silikonschutz  
Silicone handle cover  
Protector de silicone

Ref	€	L (cm)	U.Venta
23900	6,40	13,5	1

- Mango protector de silicona de alta calidad para sartenes.
- Fácil de colocar, se ajusta perfectamente al mango de la sartén.
- Antideslizante y termorresistente, protege de las temperaturas elevadas.
- Compatible con nuestras sartenes Robust, Ferrum, Dynamic y Tricapa Plus (Ø16-32).

- Manche de protection en silicone de grande qualité pour poêles.
- Facile à installer, il s'adapte parfaitement au manche de la poêle.
- Antidérapant et thermorésistant, il protège des températures élevées.
- Compatible avec nos poêles Ferrum, Robust, Dynamic et Tricapa Plus (Ø16-32).

- High quality protective silicone handle for frying pans.
- Easy to put on, it fits the pan handle perfectly.
- Non-slip and heat-resistant, it protects from high temperatures.
- Compatible with our Ferrum, Robust, Dynamic and Tricapa Plus frying pans (Ø16-32).



## Tapa de cristal con desvaporizador

Couvercle en verre avec sortie de vapeur  
Glasdeckel mit Dampfloch  
Glass Lid with steam hole  
Tampa de vidro con desvaporizador

Ref	€	Ø (cm)	U.Venta
71914	10,70	14	1
71916	11,00	16	1
71918	11,30	18	1
71920	12,20	20	1
71922	12,30	22	1
71924	12,80	24	1
71926	14,10	26	1
71928	14,70	28	1
71932	16,60	32	1



- Se adapta a todo tipo de baterías de cocina.
- Vidrio térmico resistente a altas temperaturas.
- Borde de acero inoxidable 18/10.

- Convient à tous les types d'atteries de cuisine.
- Verre trempé résistant aux températures élevées.
- Jante en acier inoxydable 18/10.

- Passend für alle Arten von Kochgeschirr.
- Gehärtetes Glas beständig gegen hohe Temperaturen.
- Felge aus Edelstahl 18/10.

- Fits all types of cookware.
- Tempered glass resistant to high temperatures.
- 18/10 stainless steel rim.

- Adequado para todos os tipos de baterias de cozinha.
- Vidro temperado resistente a altas temperaturas.
- Aro em aço inoxidável 18/10.

# Colección **ECO-PIEDRA BLACK** Doméstico



- Fabricadas en aluminio fundido de gran calidad y espesor, están reforzadas con partículas a base de piedra y una máxima resistencia al rayado, duración y desgaste.
- La base de aluminio permite una distribución homogénea del calor, permitiendo que los alimentos se cocinen rápidamente y de manera uniforme, sin apenas utilizar aceite.
- Su antiadherente TRICapa de máxima calidad y ecológico, es libre de PFOA.
- Fácil limpieza interior y exterior gracias al antiadherente.
- Fondo FULL INDUCTION compatible con todas las fuentes de calor, incluida la inducción. Excelente conductividad térmica.
- Se puede lavar en el lavavajillas.
- Paelleras - Planchas: asas fabricadas en silicona de máxima calidad, termo aislantes, altamente resistentes y ergonómicas, permiten un agarre seguro de la pieza.

- Fabriquées en fonte d'aluminium de grande qualité et épaisseur, elles sont renforcées par particules à base de pierre et confère une résistance maximale aux rayures et à l'usure pour allonger la durée de vie.
- La base en aluminium permet une distribution homogène de la chaleur, permettant aux aliments de se cuire rapidement et de façon uniforme, sans à peine utiliser d'huile Leur antiadhésif.
- Tri-couche d'une qualité maximale et écologique, est sans PFOA.
- Intérieur et extérieur faciles à nettoyer grâce à la protection antiadhésive.
- Fond « FULL INDUCTION » compatible avec toutes les sources de chaleur, y compris l'induction. Excellente conductivité thermique.
- Peut être lavées au lave-vaisselle.
- Plat à paella - Planches : poignées fabriquées en silicone de la plus grande qualité, thermo-isolantes, hautement résistantes et ergonomiques, qui permettent de tenir l'ustensile en toute sécurité.

- Aus besonders dickem und qualitativem Aluminium gegossen und mit Steinbeschichtung mit Steinbeimischung und maximaler Lebensdauer, Kratzfestigkeit und Widerstandsfähigkeit.
- Aluminiumgrundlage sorgt für gleichmäßige Wärmeverteilung um Lebensmittel schnell und gleichmäßig und ohne viel Öl zu kochen Umweltfreundliche und qualitativvolle.
- Antihafbeschichtung TRICapa ohne PFOA.
- Innen und außen einfach zu reinigen, dank Antihafbeschichtung.
- FULL INDUCTION-Boden für alle Herdarten geeignet, einschließlich Induktion Hervorragende Wärmeleitfähigkeit.
- Waschmaschinen tauglich.
- Pfanne - Platte Grill: Hochwertige, ergonomische Silikongriffe mit hoher Temperaturfestigkeit gewährleisten ein sicheres Halten des Geschirrs.



## Sartén

Poêle  
Pfanne  
Frying pan  
Sertã

Ref	€	ØD (cm)	Ød (cm)	h (cm)	e (mm)	U.Venta
24118	27,20	18	14,0	5,0	4,0	6
24120	30,90	20	14,5	5,0	4,0	6
24122	32,90	22	15,6	5,5	4,0	6
24124	35,70	24	17,4	6,0	4,0	6
24126	39,80	26	18,4	6,0	4,0	6
24128	42,30	28	20,5	6,0	4,0	6
24130	45,00	30	21,0	6,0	4,0	6

- Made in high quality and thickness cast aluminium, it is reinforced with stone-based particles and maximum scratch and wear resistance and durability.
- The aluminium base allows for a homogeneous heat distribution, allowing the food to cook quickly and uniformly, without barely any oil.
- Its high quality and eco-friendly non-stick coating TRICapa is PFOA-free.
- Easy to clean interior and exterior with its non-stick protection.
- FULL INDUCTION base that can be used with all kinds of heat sources, including induction cookers. Excellent thermal conductivity.
- Dishwasher safe.
- Round dish - Grill plaque: heat insulating, highly resistant, ergonomic handles made of high quality silicone which provide a secure grip on pots and pans.

- Fabricadas em alumínio fundido de grande qualidade e espessura, reforçadas com partículas à base de pedra, durável e resistente aos riscos e ao desgaste.
- A base de alumínio permite uma distribuição homogénea do calor, e uma cocção mais rápida de uniforme dos alimentos, com uma quantidade mínima de óleo.
- Revestimento antiaderente TRICapa de máxima qualidade e ecológico, sem PFOA.
- Fácil limpeza interior e exterior graças à sua proteção antiaderente.
- Fundo "FULL INDUCTION", compatível com todo o tipo de fontes de calor, incluindo placas de indução. Excelente condutividade térmica.
- Para máquinas de lavar louça.
- Paelheiras - Planchas: asas fabricadas em silicone de grande qualidade, termoisolantes, altamente resistentes e ergonómicas, que permitem agarrar a peça com segurança.

## Wok

Wok  
Wok  
Wok  
Wok



Ref	€	ØD (cm)	Ød (cm)	h (cm)	e (mm)	U.Venta
24138	43,00	28	16,0	9,0	4,0	1

## Sartén Blinis

Poêle Blinis  
Pfanne Blinis  
Frying pan Blinis  
Sertã Blinis



Ref	€	ØD (cm)	Ød (cm)	h (cm)	e (mm)	U.Venta
24114	13,00	14	10,0	5,6	4,0	1

new

**Full Induction**

TOTAL



Incluye asas de silicona  
Includes silicone handles

**Paellera**

Plat à paella  
Pfanne  
Round dish  
Paelheira

Ref	€	ØD (cm)	Ød (cm)	h (cm)	Raciones	e (mm)	U.Venta
25432	74,50	32	25,5	4,5	5	1,6	1
25436	79,70	36	29,5	4,5	7	2,0	1
25440	93,00	40	33,5	4,5	9	2,0	1

**Si**

Silicone

**Asas para paellera ECO-PIEDRA**

Poignées pour plat rond  
Griffschutz for Pfanne  
Handles for round dish  
Asas para paelheira

Ref	€	Ø (cm)	U.Venta
R25436A	11,60	32-36-40	1



**Grill liso**

Grill lisse  
Grill glatt  
Grill flat  
Grelhador liso



Ref	€	cm	Ød (cm)	h (cm)	e (mm)	U.Venta
24123	37,10	24x24	16,7	4,5	4,0	1
24127	44,60	28x28	19,0	4,5	4,0	1

**Grill**

Grill  
Grill  
Grill  
Grelhador



Ref	€	cm	Ød (cm)	h (cm)	e (mm)	U.Venta
24125	37,20	24x24	16,7	4,5	4,0	1
24129	44,70	28x28	19,0	4,5	4,0	1

**Crepera**

Crépiere  
Crêpes Pfanne  
Crepiere  
Crepeira



Ref	€	ØD (cm)	Ød (cm)	h (cm)	e (mm)	U.Venta
24137	32,50	24	17,0	1,8	4,0	1
24136	36,10	26	18,0	1,8	4,0	1

Incluye asas de silicona  
Includes silicone handles



**Plancha Grill**

Plaque à Grill  
Platte Grill  
Grill plaque  
Plancha Grill



Fondo NO Full Induction  
NOT Full induction bottom

Ref	€	Area cocción (cm)	ØBase (cm)	h (cm)	cm (Total)	e (mm)
25536	37,00	25,5x20	18,0	1,5	37,5x23x4,5	4,0
25547	51,30	33,5x25	21,0	2,0	47,5x29x5,5	4,0



**Plancha Grill**

Plaque à Grill  
Platte Grill  
Grill plaque  
Plancha Grill



Incluye asas de silicona  
Includes silicone handles

Ref	€	Area cocción (cm)	ØBase (cm)	h (cm)	cm (Total)	e (mm)	U.Venta
24134	65,10	33x25	24,0	2,0	46x27,5x6	4,0	1



**Plancha Grill lisa**

Plaque à Grill lisse  
Platte Grill, glatt  
Grill flat plaque  
Plancha Grill lisa



Incluye asas de silicona  
Includes silicone handles

Ref	€	Area cocción (cm)	ØBase (cm)	h (cm)	cm (Total)	e (mm)	U.Venta
24135	67,70	33x25	24,0	2,0	46x27,5x6	4,0	1

**Si**

Silicone

**Asas para plancha Grill GREY**

Poignées pour plaque à Grill  
Griffschutz for Platte Grill  
Handles for grill plaque  
Asas para plancha Grill



Ref	€	cm	U.Venta
R25736A	4,00	36	1
R25747A	5,60	47	1

**Si**

Silicone

**Asas para plancha Grill RED**

Poignées pour plaque à Grill  
Griffschutz for Platte Grill  
Handles for grill plaque  
Asas para plancha Grill



Ref	€	cm	U.Venta
R25536A	4,00	36	1
R25547A	5,60	47	1

# Plancha Grill TitanFull

new



- Fabricada en aluminio fundido de gran calidad.
- Diseñada para cocinar todo tipo de verduras, carnes, pescados, etc. de forma saludable y sin apenas utilizar aceite.
- Recubrimiento antiadherente TRlcapa Quantanium® acabado en partículas de titanio, libre de materiales tóxicos y pesados. Ecológico y 100% libre de PFOA.
- Ahorro energético, hasta un 45% más eficiente, gracias a su fondo FULL INDUCTION.
- **DISTRIBUCIÓN HOMOGÉNEA DEL CALOR: permite que los alimentos se cocinen rápidamente y de manera uniforme.**
- Diseñada para uso doméstico y rendimiento profesional.
- Máxima resistencia al desgaste.
- Compatible con todo tipo de cocinas, incluida la inducción.

- Fabriqué en fonte d'aluminium de grande qualité
- Conçue pour cuisiner tous types de légumes, viandes, poissons, etc. de façon saine et sans à peine utiliser d'huile.
- Revêtement antiadhésif TRI-couche Quantanium® avec finition en particules de titane, sans produits toxiques ni métaux lourds. Écologique et 100% sans PFOA.
- Économies d'énergie : jusqu'à 45% plus efficace grâce à son fond FULL INDUCTION rectangulaire.
- Distribution homogène de la chaleur : les aliments cuisent uniformément, sans à peine ajouter d'huile.
- Conçue aussi bien pour une utilisation professionnelle que domestique.
- Résistance maximale contre l'usure.
- Compatible avec tous types de feu, y compris l'induction.

- Grillplatte aus besonders dickem und hochwertigem Aluminiumguss.
- Zum Kochen aller möglichen Sorten von Gemüse, Fleisch, Fisch usw. Gesund und praktisch ohne Fett.
- TRlcapa Quantanium® Antihafbeschichtung mit Titan beimischung, frei von Giftstoffen und Schwermetallen Umweltfreundlich und 100 % frei von PFOA.
- Spart Energie dank 45 % effizienterem FULL INDUCTION-Boden (rechteckig).
- Gleichmäßige Wärmeverteilung ermöglicht, Lebensmittel schnell und gleichmäßig und ohne viel Öl zu kochen.
- Für den häuslichen und professionellen Gebrauch geeignet.
- Sehr verschleißfest.
- Innen und außen einfach zu reinigen, dank Antihafbeschichtung.

- Kitchen grill made of high quality very thick cast aluminium.
- Designed for cooking all kinds of vegetables, meat, fish, etc. in a healthy way with hardly any oil.
- TRlcapa Quantanium® non-stick coating finished with titanium particles, free of toxic materials and heavy metals.
- Environmentally friendly and 100% PFOA free.
- Energy saving, up to 45% more efficient because of its rectangular FULL INDUCTION bottom.
- Even heat distribution: food can be cooked quickly and evenly with hardly any oil.
- Designed for home use and professional performance.
- Maximum wear resistance.
- Compatible with all kinds of cookers, including induction.

- Fabricada em alumínio fundido de grande qualidade.
- Para cozinhar todo o tipo de verduras, carnes, peixes, etc., de maneira saudável e quase sem utilizar óleo.
- Revestimento antiaderente TRlcapa Quantanium® com partículas de titânio, livre de materiais tóxicos e pesados. Ecológico e 100% livre de PFOA
- Poupança energética: até 45% mais eficiente, graças ao seu fundo FULL INDUCTION retangular
- Distribuição homogénea do calor, que permite que os alimentos se cozinhem rapidamente e de maneira uniforme.
- Para uso doméstico e rendimento profissional.
- Máxima resistência ao desgaste.
- Compatível com todo o tipo de fogões, incluindo os de indução.

- **Antiadherente QuanTanium® reforzado con partículas de titanio; libre de materiales tóxicos y pesados, ecológico y libre de PFOA.**
- QuanTanium® non-stick reinforced with titanium particles; free from toxic and heavy materials, environmentally friendly and PFOA-free.

 **Full Induction**  
TOTAL



**Incluye asas de silicona**  
Includes silicone handles

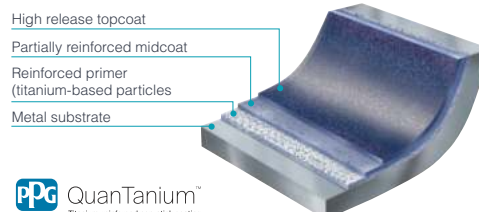

**PPG** Quantanium™  
Titanium-reinforced non-stick coating

## Plancha Grill

Plaque à Grill  
Platte Grill  
Grill plaque  
Plancha Grill

Ref	€	Area cocción (cm)	h (cm)	e (mm)	U.Venta
24347	110,50	28x28	3	5,0	1

# Sartén ETERNITY

new



- Fabricada en aluminio fundido de máxima calidad.
- Antiadherente QuanTanium® reforzado con partículas de titanio; libre de tóxicos, materiales pesados y sin PFOA.
- Diseñada para una cocina saludable: permite cocinar sin apenas aceite garantizando que los alimentos no se peguen.
- Fondo difusor FULL INDUCTION; asegura un rendimiento óptimo en todo tipo de cocinas, con un reparto de calor inmejorable logrando la máxima eficiencia y ahorro de energía.
- Máxima garantía en cuanto a resistencia, durabilidad e higiene.
- Mango ergonómico soft touch termoaislante.
- Compatible con todo tipo de cocinas, incluida la inducción.

- Fabriqué en fonte d'aluminium de la plus grande qualité.
- Antiadhésif QuanTanium® renforcé avec des particules de titane ; sans produits toxiques ni métaux lourds et sans PFOA.
- Conçue pour une cuisine saine : permet de cuisiner sans à peine utiliser d'huile avec la garantie que les aliments ne collent pas.
- Fond diffuseur FULL INDUCTION qui garantit un rendement optimal sur tous les types de feux, avec une répartition parfaite de la chaleur, conférant ainsi une efficacité maximale et une économie d'énergie.
- Garantie maximale en termes de résistance, de durabilité et d'hygiène.
- Manche ergonomique soft touch thermorésistant.
- Compatible avec tout type de feux, y compris l'induction.

- Aus Aluminiumguss höchster Qualität.
- Antihftbeschichtung QuanTanium® mit Titanbeimischung, frei von Schadstoffen, Schwermetallen und ohne PFOA.
- Für eine gesunde Küche: Schon wenig Öl reicht aus und es bleibt garantiert nichts kleben.
- Diffusionsboden „Full Induction“ für beste Kochergebnisse auf allen Herdarten, optimale Hitzeverteilung für maximale Effizienz und Energieeinsparung.
- Garantiert robust, langlebig und hygienisch.
- Ergonomischer, hitzebeständiger Soft Touch-Griff.
- Mit allen Herdarten kompatibel (inkl. Induktion).

- It's made of maximum quality cast aluminium.
- It has a QuanTanium® non-stick coating reinforced with titanium particles. It's free of toxins, heavy metals and it's PFOA free.
- It's designed for healthy cooking. You can cook with hardly any oil while being sure food won't stick.
- The FULL INDUCTION diffuser bottom ensures optimal performance on all kinds of cookers with unbeatable heat distribution that achieves maximum efficiency and energy savings.
- It has a maximum guarantee for strength, durability and hygiene.
- It has an ergonomic thermoresistant soft touch handle.
- It's compatible with all kinds of cookers, including induction.

- Fabricada em alumínio fundido da máxima qualidade.
- Antiaderente QuanTanium® reforçado com partículas de titânio; não contém materiais tóxicos ou pesados, nem PFOA.
- Concebida para uma cozinha saudável: permite cozinhar praticamente sem utilizar óleo, sem que os alimentos se peguem.
- Fundo difusor FULL INDUCTION, que assegura um rendimento ótimo em todo o tipo de fogões, com uma excelente distribuição do calor para máxima eficiência e poupança de energia.
- Máxima garantia de resistência, durabilidade e higiene.
- Cabo ergonómico e termo resistente "Soft Touch".
- Compatível com todo o tipo de fogões e placas de cocção, incluindo as de indução.

- Antiadherente QuanTanium® reforzado con partículas de titanio; libre de materiales tóxicos y pesados, ecológico y libre de PFOA.
- QuanTanium® non-stick reinforced with titanium particles; free from toxic and heavy materials, environmentally friendly and PFOA-free.

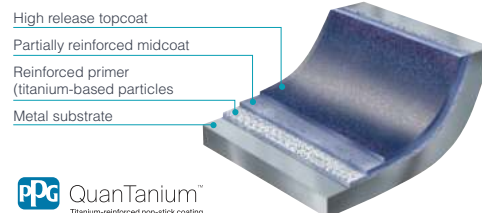

PPG QuanTanium™  
Titanium-reinforced non-stick coating

Full Induction  
TOTAL



## Sartén

Poêle  
Pfanne  
Frying pan  
Sertã

Ref	€	ØD (cm)	Ød (cm)	h (cm)	e (mm)	U.Venta
27120	29,20	20	14,0	5,0	1,8	6
27122	33,80	22	14,0	5,5	1,8	6
27124	38,10	24	15,5	5,5	1,8	6
27126	44,10	26	17,0	6,0	1,8	6
27128	49,10	28	18,5	6,0	1,8	6
27130	54,70	30	19,5	6,5	1,8	6
27132	61,30	32	21,5	6,5	1,8	6

# Colección **TITANIUM**<sup>PRO</sup>



## Sartén

Poêle  
Pfanne  
Frying-pan  
Sertã



Ref	€	ØD (cm)	Ød (cm)	h (cm)	U.Venta
27820	30,70	20	16,6	5,0	6
27824	37,80	24	20,2	5,5	4
27828	45,90	28	23,4	6,0	6

- Cuerpo fabricado en aluminio fundido en una sola pieza.
- Antiadherente Quantanium.
- Recubrimiento de máxima calidad reforzada con partículas a base de titanio.

- Body made of cast aluminum in one piece construction.
- Quantanium non-stick.
- Top quality coating reinforced with titanium-based particles.

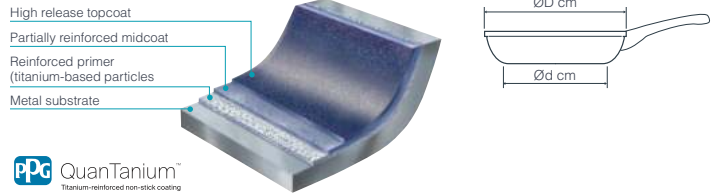

4 in 1



## Sartén 4 cavidades

Poêle 4 cavités  
Pfanne, 4-fache Einteilung  
Frying-pan 4 cavities  
Sertã 4 cavidades

Ref	€	cm	Ød (cm)	h (cm)	U.Venta
27832	46,20	32x26	21,0	3,5	1



## Grill

Grill  
Grill Induktionfähig  
Grill  
Grelhador



Ref	€	cm	Ød (cm)	h (cm)	U.Venta
27827	53,40	28x28	21,0	4,0	1

# Colección **STILO**



## Sartén

Poêle  
Pfanne  
Frying pan  
Sertã



Ref	€	ØD (cm)	Ød (cm)	h (cm)	U.Venta
27620	34,60	20	16,5	4,5	6
27624	39,50	24	20,0	5,2	6
27626	43,60	26	21,5	5,5	6
27628	47,10	28	24,0	6,0	6

- Cuerpo fabricado en una sola pieza.
- Fabricada en aluminio fundido de gran robustez.
- Recubrimiento en piedra hiperresistente a los arañazos.
- Revestimiento antiadherente de alta calidad y ecológico, libre de PFOA.
- Apta para todo tipo de cocinas, incluida la inducción.

- Construite en une seule pièce.
- Fabriquée en fonte d'aluminium d'une grande robustesse.
- Revêtement en pierre hyper résistant aux rayures.
- Revêtement antiadhésif de grande qualité et écologique, exempt de PFOA.
- Compatible avec tout type de cuisines, y compris l'induction.

- Aus einem Stück gefertigt.
- Aus sehr widerstandsfähigem druckgegossenem Aluminium.
- Mit kratzfestem Steinüberzug.
- Mit hochwertiger, ökologischer Antihftbeschichtung, PFOA frei.
- Geeignet für alle Art von Kochfeldern, inklusive Induktion.

- Body made in one piece.
- Manufactured in highly-robust cast aluminium.
- Super scratch-resistant stone coating.
- High-quality, ecological, PFOA-free anti-stick coating.
- Suitable for all types of kitchens, including those with induction cookers.

## Grill

Grill  
Grill Induktionfähig  
Grill  
Grelhador



Ref	€	cm	Ød (cm)	h (cm)	U.Venta
27625	43,60	24x24	18,6	4,8	1
27629	50,50	28x28	21,5	5,2	1

- Elementos fabricados a partir de uma única peça.
- Fabricada em alumínio fundido de grande robustez.
- Fabricada em alumínio fundido de grande robustez.
- Revestimento antiaderente de alta qualidade e ecológico, isento de PFOA.
- Apta para todo o tipo de fogões, incluindo placas de indução.

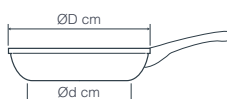

# Sartén Grill SUA

new



- Sartén parrilla grill fabricada en aluminio fundido de máxima calidad.
- Acabado antiadherente bicapa de alta calidad y 100% libre de PFOA. Libre de materiales tóxicos, pesados, disolventes y sustancias químicas.
- Diseñadas para una cocina saludable: permite cocinar sin apenas aceite garantizando que los alimentos no se peguen.
- Mango fabricado en madera de roble, totalmente plegable y ultrarresistente al calor.
- Máxima eficiencia y ahorro de energía; su fondo difusor FULL INDUCTION está especialmente diseñado para repartir el calor de manera rápida y uniforme a lo largo de toda la superficie (base + paredes), consiguiendo así que los alimentos se cocinen de forma uniforme por toda la superficie.
- Apta para todo tipo de fuegos: gas, eléctrica, vitrocerámica e inducción.

- Poêle-grill fabriquée en fonte d'aluminium de la plus grande qualité.
- Finition antiadhésive bi-couche de grande qualité et 100% sans PFOA. Sans matériaux toxiques, métaux lourds, dissolvants ni substances chimiques.
- Conçue pour une cuisine saine : permet de cuisiner sans à peine utiliser d'huile en garantissant que les aliments ne collent pas.
- Manche fabriqué en chêne, entièrement pliable et ultra résistant à la chaleur.
- Efficacité et économies d'énergie maximales : son fond diffuseur FULL INDUCTION a été spécialement conçu pour répartir la chaleur de façon rapide et uniforme sur toute la surface (base + parois), obtenant ainsi une cuisson des aliments uniforme sur toute la surface.
- Apte pour tout type de cuisinières : gaz, électrique, vitrocéramique et induction.

- Grillpfanne aus Aluminiumguss bester Qualität.
- Hochwertige zweilagige Antihaftbeschichtung frei von PFOA. Ohne Giftstoffe, Schwermetalle, Lösungsmittel und chemische Stoffe.
- Für eine gesunde Küche: Schon wenig Öl reicht aus und es bleibt garantiert nichts kleben.
- Eichenholzstiel, klappbar, hochgradig hitzebeständig.
- Maximale Effizienz und Energieeinsparung, Diffusionsboden „FULL INDUCTION“ sorgt für schnelle und gleichmäßige Wärmeverteilung auf der gesamten Fläche (Boden und Rand) für Einheitliche Ergebnisse auf der gesamten Bratfläche.
- Für alle Herdarten geeignet: Gas, Elektro, Glaskeramik und Induktion.

- Grill frying pan made of top quality cast aluminium.
- It has a high quality bi-layer non-stick coating that is 100% PFOA free. It's free of toxic materials, heavy metals, solvents and chemical substances.
- Designed for healthy cooking, it lets you cook with practically no oil with the assurance that food will not stick.
- It has a wooden handle that can be folded and is ultra heat resistant.
- Maximum efficiency and energy savings. The FULL INDUCTION diffuser bottom is specially designed to distribute heat quickly and evenly through the entire surface (base + sides). That means food is cooked evenly on the entire surface.
- It's suitable for all kinds of cookers: gas, electric, vitroceramic and induction.

- Sertã para grelhar fabricada em alumínio fundido da máxima qualidade.
- Acabamento antiaderente bicapa de alta qualidade, 100% livre de PFOA e de materiais tóxicos, pesados, disolventes e substâncias químicas.
- Concebida para uma cozinha saudável: permite cozinhar praticamente sem óleo, sem que os alimentos se agarrem ao fundo.
- Cabo fabricado em madeira de carvalho, totalmente dobrável e ultrarresistente ao calor.
- Máxima eficiência e poupança de energia; o seu fundo difusor FULL INDUCTION está especialmente concebido para distribuir o calor de maneira rápida e uniforme por toda a superfície (base + paredes), conseguindo assim uma cocção uniforme dos alimentos.
- Apta para todo o tipo de placas de cocção: a gás, elétricas, vitrocerâmicas e de indução.

Acanalada  
Ribbed



## Grill

Grill  
Grill Induktionfähig  
Grill  
Grelhador

Ref	€	cm	Øh (cm)	e (mm)	U.Venta
25144	27,60	24x24	3,7	1,7	1
25148	33,60	28x28	3,8	1,7	1

Lisa  
Flat



## Grill

Grill  
Grill Induktionfähig  
Grill  
Grelhador

Ref	€	cm	Øh (cm)	e (mm)	U.Venta
25154	27,60	24x24	3,7	1,7	1
25158	33,60	28x28	3,8	1,7	1



Mango abatible  
de madera de roble  
Wooden folded handle



# Colección JAVA

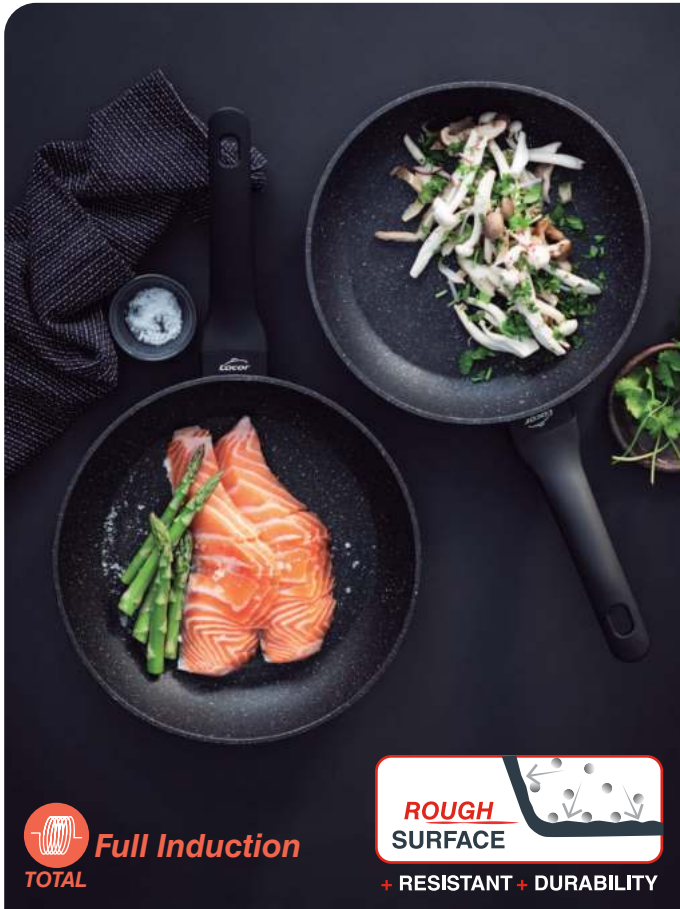

- Fabricada en aluminio forjado de máxima calidad.
- Antiadherente interior y exterior reforzado a base de partículas de piedra.
- Ecológico, libre de materiales tóxicos y pesados. Libre de PFOA.
- Fondo FULL INDUCTION compatible con todas las fuentes de calor, incluida la inducción. Excelente conductividad térmica.

- Fabriqué en aluminium forgé de la plus grande qualité.
- Antiadhésif intérieur et extérieur renforcé à base de particules de pierre.
- Écologique, exempt de matériaux toxiques et lourds. Sans PFOA.
- Fond « FULL INDUCTION » compatible avec toutes les sources de chaleur, y compris l'induction. Excellente conductivité thermique.

- Aus geschmiedetes Aluminium höchster Qualität.
- Anti-Haft-Wände innen und außen, verstärkt mit Steinbeimischung.
- Ökologisch, frei von giftigen und schweren Stoffen. Ohne PFOA.
- FULL INDUCTION-Boden für alle Herdarten geeignet, einschließlich Induktion. Hervorragende Wärmeleitfähigkeit.

- Made of high quality forged aluminum.
- Reinforced non-stick coating inside and outside using stone particles.
- Ecological, free of toxic and heavy materials. PFOA free.
- FULL INDUCTION base that can be used with all kinds of heat sources, including induction cookers. Excellent thermal conductivity.

- Fabricada em alumínio forjado da máxima qualidade.
- Revestimento antiaderente interior e exterior reforçado, à base de partículas de pedra.
- Ecológico, livre de materiais tóxicos e pesados. Livre de PFOA.
- Fundo "FULL INDUCTION", compatível com todo o tipo de fontes de calor, incluindo placas de indução. Excelente condutividade térmica.

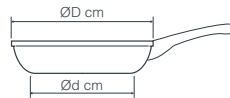

## Sartén

Poêle  
Pfanne  
Frying-pan  
Sertã

Ref	€	ØD (cm)	Ød (cm)	h (cm)	e (mm)	U.Venta
26816	14,00	16	13,0	4,0	3,0	6 <span style="color:red">new</span>
26818	15,00	18	13,8	4,0	3,0	6
26820	16,40	20	15,6	4,0	3,0	6
26822	18,50	22	17,4	4,5	3,0	6
26824	20,10	24	19,0	4,5	3,0	6
26826	22,20	26	20,4	5,0	3,0	6
26828	24,10	28	22,4	5,5	3,0	6
26830	26,80	30	23,7	5,5	3,0	6
26832	37,20	32	25,0	5,5	3,0	6 <span style="color:red">new</span>

## Wok

Wok  
Wok  
Wok  
Wok



Ref	€	ØD (cm)	Ød (cm)	h (cm)	e (mm)	U.Venta
26848	23,80	28	17,0	8,0	3,0	1

## Grill

Grill  
Grill Induktionfähig  
Grill  
Grelhador



Ref	€	cm	Ød (cm)	h (cm)	e (mm)	U.Venta
26858	27,10	28 x 28	24,2	4,5	3,0	1

## Crepera

Crépiere  
Crêpes Pfanne  
Crepiera  
Crepeira



Ref	€	ØD (cm)	Ød (cm)	h (cm)	e (mm)	U.Venta
26844	18,60	24	21,6	2,0	3,0	1

## Sartén honda

Poêle profonde  
Tiefe Pfanne  
Deep frying-pan  
Sertã funda



Ref	€	ØD (cm)	Ød (cm)	h (cm)	e (mm)	U.Venta
26834	21,40	24	18,5	6,5	3,0	1
26838	25,30	28	22,2	7,0	3,0	1

# Colección EASY



**Mango de fundición de acero inoxidable**  
Cast stainless steel handle

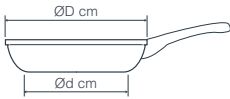

## Sartén

Poêle  
Pfanne  
Frying-pan  
Sertã

Ref	€	ØD (cm)	Ød (cm)	h (cm)	e (mm)	U.Venta
27018	20,50	18	14,0	4,0	3,0	6
27020	21,30	20	15,6	4,0	3,0	6
27022	23,10	22	17,7	4,5	3,0	6
27024	25,00	24	18,8	4,5	3,0	6
27026	27,20	26	20,5	5,0	3,0	6
27028	29,80	28	22,0	5,5	3,0	6
27030	32,60	30	24,0	5,5	3,0	6
27032	34,50	32	25,0	6,0	3,0	6

- Fabricada en aluminio forjado de máxima calidad.
- Recubrimiento antiadherente Whitford reforzado de máxima calidad y libre de PFOA.
- Antiadherente interior reforzado a base de partículas de piedra.
- Fondo FULL INDUCTION compatible con todas las fuentes de calor, incluida la inducción. Excelente conductividad térmica.

- Fabriqué en aluminium forgé de la plus grande qualité.
- Revêtement antiadhésif renforcé Whitford de qualité supérieure et sans PFOA.
- Antiadhésif intérieur renforcé à base de particules de pierre.
- Fond « FULL INDUCTION » compatible avec toutes les sources de chaleur, y compris l'induction. Excellente conductivité thermique.

- Aus geschmiedetes Aluminium höchster Qualität.
- Hochwertige Whitford-verstärkte Antihafbeschichtung und PFOA-frei.
- Anti-Haft-Wände innen, verstärkt mit Steinbeimischung.
- FULL INDUCTION-Boden für alle Herdarten geeignet, einschließlich Induktion. Hervorragende Wärmeleitfähigkeit.

- Made of high quality forged aluminum.
- Top quality Whitford reinforced non-stick coating and PFOA-free.
- Reinforced non-stick coating inside using stone particles.
- FULL INDUCTION base that can be used with all kinds of heat sources, including induction cookers. Excellent thermal conductivity.

- Fabricada em alumínio forjado da máxima qualidade.
- Revestimento antiaderente reforçado Whitford de alta qualidade e livre de PFOA.
- Revestimento antiaderente interior reforçado, à base de partículas de pedra.
- Fundo "FULL INDUCTION", compatível com todo o tipo de fontes de calor, incluindo placas de indução. Excelente condutividade térmica.

# Colección VOGA



**Acero inoxidable, no se calienta**  
St steel, heat-resistant

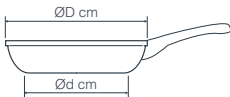

## Sartén VOGA

Poêle  
Pfanne  
Frying-pan  
Sertã

Ref	€	ØD (cm)	Ød (cm)	h (cm)	e (mm)	U.Venta
24720	32,50	20	14,6	4,5	4,0	6
24722	35,50	22	15,6	5,0	4,0	6
24724	39,80	24	17,7	5,0	4,0	6
24726	44,00	26	18,8	5,5	4,0	6
24728	47,10	28	20,4	6,0	4,0	6
24732	54,90	32	23,3	6,5	4,0	6

- Fabricado en aluminio forjado, acabado fuerte y robusto.
- Calentamiento rápido y uniforme.
- Recubrimiento antiadherente ILAG:ULTIMATE (Tricapa) de gran calidad ultrarresistente y de uso intensivo.
- Mango de acero inoxidable, no se calienta.

- Fabriqué en aluminium forgé, finition solide et robuste.
- Chauffe rapide et uniforme.
- Revêtement antiadhésif ILAG:ULTIMATE (tri-couche) de grande qualité ultra résistant et à usage intensif.
- Manche en acier inoxydable, ne chauffe pas.

- Hergestellt aus geschmiedetem Aluminium, starke und robuste Verarbeitung.
- Schnelle und gleichmäßige Erwärmung.
- Qualitativ hochwertige und widerstandsfähige Antihafbeschichtung ILAG:ULTIMATE (dreifach) für hohe Beanspruchung.
- Edelstahlgriff wird nicht heiß.

- Made of forged aluminium, strong and robust finish.
- Quick and even heating.
- Ultra-resistant high-quality ILAG:ULTIMATE non-stick coating (Triple-layer) for intensive use.
- Heat-resistant stainless steel handle.

- Fabricado em alumínio forjado, com um acabamento forte e robusto.
- Aquecimento rápido e uniforme.
- Revestimento antiaderente ILAG:ULTIMATE (Tricapa) de grande qualidade, ultra-resistente e de uso intensivo.
- Mango de aço inoxidável, que não aquece.

# Set sartenes FOGO



**Fondo FULL INDUCTION**  
FULL INDUCTION bottom

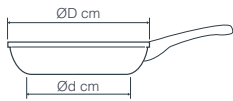

## Set 2 sartenes

Set 2 poêles  
Set 2 Bratpfannen  
Set 2 frying pans  
Conjunto 2 sertãs

Ref	€	ØD (cm)	Ød (cm)	h (cm)	e (mm)	U.Venta
26400	33,80	20	14,5	4,2	3,0	1
		24	18,0	4,7	3,0	

- Fabricada en aluminio forjado de máxima calidad.
- Recubrimiento antiadherente reforzado TRlcapa.
- Ecológico, libre de materiales tóxicos y pesados, libre de PFOA.
- Fondo FULL INDUCTION compatible con todas las fuentes de calor, incluida la inducción.
- Excelente conductividad térmica.

- Fabriqué en aluminium forgé de la plus grande qualité.
- Revêtement antiadhésif renforcé TRlcapa.
- Écologique, exempt de matériaux toxiques et lourds. Sans PFOA.
- Fond « FULL INDUCTION » compatible avec toutes les sources de chaleur, y compris l'induction.
- Excellente conductivité thermique.

- Aus geschmiedetes Aluminium höchster Qualität.
- Mit verstärkter Antihafbeschichtung, beste Qualität TRlcapa.
- Ökologisch, frei von giftigen und schweren Stoffen. Ohne PFOA.
- FULL INDUCTION-Boden für alle Herdarten geeignet, einschließlich Induktion.
- Hervorragende Wärmeleitfähigkeit.

- Made of high quality forged aluminum.
- Reinforced non-stick TRlcapa coating.
- Ecological, free of toxic and heavy materials. PFOA free.
- FULL INDUCTION base that can be used with all kinds of heat sources, including induction cookers.
- Excellent thermal conductivity.

- Fabricada em alumínio forjado da máxima qualidade.
- Revestimento antiaderente reforçado TRlcapa.
- Ecológico, livre de materiais tóxicos e pesados. Livre de PFOA..
- Fundo "FULL INDUCTION", compatível com todo o tipo de fontes de calor, incluindo placas de indução.
- Excelente condutividade térmica.

# Sartén FIT

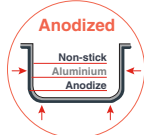

**Capa de óxido natural**  
Natural oxide layer



**Muy resistentes a arañazos, deformaciones y corrosión**  
Very resistant to scratches, deformation and corrosion

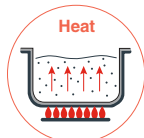

**Distribuye uniformemente el calor**  
Uniform heat distribution

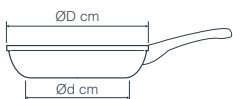

**Acero inoxidable, no se calienta**  
Stainless steel, heat-resistant



## Sartén

Poêle  
Pfanne  
Frying pan  
Sertã

Ref	€	ØD (cm)	Ød (cm)	h (cm)	e (mm)	U.Venta
48720	32,30	20	15,0	4,0	4,5	6
48724	40,40	24	18,0	4,5	4,5	6
48728	48,20	28	22,0	5,0	4,5	6

- Gracias al tratamiento electrolítico empleado en su proceso de fabricación, el aluminio se sella completamente y se endurece para que no pase a los alimentos.
- Antiadherente QuanTanium® reforzado con partículas de titanio; libre de tóxicos, materiales pesados y sin PFOA.
- Gran durabilidad y ultraresistente: superficie robusta altamente resistente a roces, deformación y corrosión.

- Grâce au traitement électrolytique utilisé lors de son processus de fabrication, l'aluminium est totalement scellé et durcit pour ne pas pouvoir atteindre les aliments.
- Revêtement antiadhésif QuanTanium® renforcé avec des particules de titane; sans produits toxiques, sans matériaux lourds et sans PFOA.
- Grande durabilité et ultra résistante : Surface robuste hautement résistante aux rayures, à la déformation et à la corrosion.

- Because of the electrolytic treatment used in the manufacturing process, the aluminium is completely sealed and hardened so no metal is passed on to the food.
- Non-stick QuanTanium®, reinforced with titanium particles, is free of toxins, heavy metals and PFOA.
- Extremely durable and ultra-high strength: It has a robust surface that is highly resistant to abrasion, warping and corrosion.

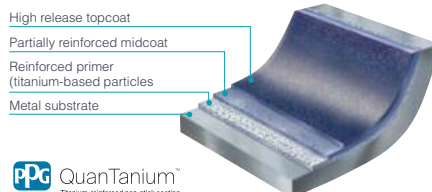

PPG QuanTanium™  
Titanium-reinforced non-stick coating

# Sartén LOFT



- Fabricada en aluminio embutido, acabado fuerte y robusto.
- Recubrimiento antiadherente. Calidad y larga duración.
- Exterior en negro mate.
- Calentamiento rápido y uniforme.
- Mango SOFT TOUCH.

Mango SOFT TOUCH  
SOFT TOUCH handle

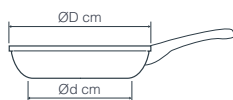

- Fabriquée en aluminium embouti, finition forte et robuste.
- Revêtement antiadhésif. Qualité et longue durée de vie..
- Extérieur en noir mat.
- Chauffe rapide et uniforme.
- Manche SOFT TOUCH.

- Aus gepresstem Aluminium mit gehärtetem und robustem Finish.
- Antihafbeschichtung. Qualität und lange Haltbarkeit.
- Mattschwarzes Äußeres.
- Gleichmäßige und schnelle Erwärmung.
- SOFT TOUCH-Griff.

- Made from deep drawn aluminium, strong and robust finish.
- Non-stick coating. Quality and long life.
- Outside in matte black.
- Quick and uniform heating.
- SOFT TOUCH handle.

- Fabricada em alumínio embutido, com acabamento forte e robusto.
- Revestimento antiaderente, de qualidade e longa duração.
- Exterior em negro mate.
- Aquecimento rápido e uniforme.
- Mango SOFT TOUCH.

## Sartén LOFT

Poêle  
Pfanne  
Frying-pan  
Sertä

Ref	€	ØD (cm)	Ød (cm)	h (cm)	e (mm)	U.Venta
24918	18,90	18	13,5	3,8	3,5	6
24920	20,70	20	14,7	4,3	3,5	6
24922	22,30	22	16,5	4,3	3,5	6
24924	24,90	24	17,6	4,8	3,5	6
24926	26,60	26	19,0	4,8	3,5	6
24928	30,70	28	22,1	5,3	3,5	6

# Sartenes GARINOX & VITE



## Sartén GARINOX

Poêle  
Pfanne  
Frying-pan  
Sertä

Ref	€	ØD (cm)	Ød (cm)	h (cm)	e (mm)	U.Venta
26418	10,90	18	12,5	4,0	3,0	6
26420	12,10	20	14,7	4,0	3,0	6
26422	14,20	22	16,3	4,5	3,0	6
26424	15,70	24	17,5	4,5	3,0	6
26426	17,90	26	19,5	5,0	3,0	6
26428	19,30	28	21,0	5,0	3,0	6
26430	21,00	30	22,0	5,5	3,0	6



Fondo FULL INDUCTION  
FULL INDUCTION bottom

## Sartén VITE

Poêle  
Pfanne  
Frying-pan  
Sertä

Ref	€	ØD (cm)	Ød (cm)	h (cm)	e (mm)	U.Venta
26718	12,40	18	11,5	4,0	3,0	6
26720	13,90	20	14,3	4,0	3,0	6
26722	15,80	22	15,6	4,5	3,0	6
26724	17,40	24	17,0	4,5	3,0	6
26726	19,90	26	19,0	5,0	3,0	6
26728	22,00	28	21,5	5,0	3,0	6
26730	23,70	30	21,2	5,5	3,0	6

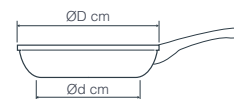

# Colección TRIMETAL



- Cuerpo fabricado en 3 capas: acero inoxidable 18/10, aluminio, acero inoxidable 18%.
- La capa exterior, es de acero inoxidable con componentes ferríticos, lo que la convierte totalmente compatible con las cocinas de inducción.
- Los mangos están fabricados en acero inoxidable 18/10 y recubiertas con un protector térmico de silicona para facilitar un agarre perfecto y seguro.

- Corps fabriqué avec 3 couches : acier inoxydable 18/10, aluminium, acier inoxydable 18%.
- La couche extérieure est en acier inoxydable avec des composants ferritiques, ce qui lui permet d'être totalement compatible avec les cuisinières à induction.
- Les manches sont fabriqués en acier inoxydable 18/10 et recouverts d'une protection thermique en silicone pour faciliter une prise en main parfaite et sûre.

- Kessel aus dreilagigem Material: rostfreier Stahl 18/10, Aluminium, rostfreier Stahl 18%.
- Induktionsherdgeeignet dank Außenschicht aus rostfreiem Stahl mit ferritischen Bestandteilen.
- Die Griffe und Stiele aus rostfreiem Stahl 18/10 und mit wärmeabweisender Silikonummantelung geben sicheren und perfekten Halt.

- Body manufactured in a 3-layered: 18/19 stainless steel, aluminium, 18% stainless steel.
- Exterior layer, of stainless steel with ferrite materials, making it completely compatible with induction cookers.
- The grips are made in 18/10 stainless steel and covered in a silicon heat protection for easy and safe gripping.

- Corpo fabricado em 3 capas: aço inoxidável 18/10, alumínio, aço inoxidável 18%.
- Capa exterior de aço inoxidável com componentes ferríticos, totalmente compatível com as placas de indução.
- Mangos fabricados em aço inoxidável 18/10, revestidos com um protetor térmico de silicone para uma sujeição perfeita e segura.

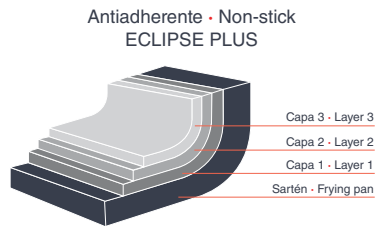

## Sartén

Poêle  
Pfanne  
Frying pan  
Sertã



Ref	€	Ø (cm)	h (cm)	e (mm)	U.Venta
53720	57,80	20	4,5	2,3	1
53724	64,40	24	5,0	2,3	1
53728	78,90	28	5,5	2,3	1



## Sartén antiadherente

Poêle antiadherent  
Pfanne, Antihalt  
Non-stick frying pan  
Sertã anti-aderente



Ref	€	Ø (cm)	h (cm)	e (mm)	U.Venta
53721	68,00	20	4,5	2,3	1
53725	81,40	24	5,0	2,3	1
53729	102,80	28	5,5	2,3	1

## Wok

Wok  
Wok  
Wok  
Wok



Ref	€	Ø (cm)	h (cm)	e (mm)	U.Venta
53828	85,80	28	8,0	2,3	1



## Wok antiadherente

Wok, Antiadherent  
Wok, Antihalt  
Wok, non-stick  
Wok anti-aderente



Ref	€	Ø (cm)	h (cm)	e (mm)	U.Venta
53829	97,50	28	8,0	2,3	1

# Sartenes INOX

Inox  
18/10



Sandwich



Vidro



Electric



Gas



Induction



Oven



Dishwasher

non-stick  
coating  
scratch  
resistant



Antiadherente · Non-stick  
ECLIPSE PLUS



## Sartén lisa HOME

Poêle, lisse  
Pfanne, glatt  
Frying-pan flat  
Sertã

Ref	€	Ø (cm)	h (cm)	e (mm)	U.Venta
71318	37,90	18	5,5	0,7	1
71320	39,80	20	5,5	0,7	1
71322	44,30	22	5,5	0,7	1
71324	48,50	24	6,0	0,7	1
71326	53,30	26	6,0	0,7	1
71328	59,80	28	6,5	0,7	1

- Fabricadas en acero inoxidable 18/10 de la mejor calidad.
- Máxima garantía en resistencia, durabilidad e higiene.
- Fondo termodifusor sandwich, distribución rápida y uniforme del calor.
- Homogeneidad y eficacia térmica. Cocción ultrarrápida.
- Aptas para todos los fuegos.

- Fabriquées en acier inoxydable 18/10 de la meilleure qualité.
- Garantie maximale de résistance, de durabilité et d'hygiène.
- Fond thermo-diffuseur sandwich, distribution rapide et uniforme de la chaleur.
- Homogénéité et efficacité thermique. Cuisson ultra-rapide.
- Aptes pour tous les feux.

- Aus Edelstahl 18/10 bester Qualität.
- Garantiert robust, langlebig und hygienisch.
- Wärmeleitender Sandwichboden, schnelle und gleichmäßige Wärmeverteilung.
- Gleichförmigkeit und thermische Effektivität. Ultraschnelles Garen.
- Für alle Herdarten geeignet.

- Made of 18/10 stainless steel of the best quality.
- Maximum guarantee in resistance, durability and hygiene.
- Heat-diffusing sandwiched base, quick and even heat distribution.
- Thermal homogeneity and efficiency. Ultra-rapid cooking.
- Suitable for all types of cookers.

- Fabricadas em aço inoxidável 18/10 da melhor qualidade.
- Máxima garantia de resistência, durabilidade e higiene.
- Fundo termodifusor tipo sanduíche, que assegura uma distribuição rápida e uniforme do calor.
- Homogeneidade e eficácia térmica. Cocção ultra-rápida.
- Aptas para todos os fogões.

non-stick  
coating  
scratch  
resistant



Antiadherente · Non-stick  
ECLIPSE PLUS



## Sartén HOME

Poêle  
Pfanne  
Frying-pan  
Sertã

Ref	€	Ø (cm)	h (cm)	e (mm)	U.Venta
71818	37,90	18	5,5	0,7	1
71820	39,80	20	5,5	0,7	1
71822	44,30	22	5,5	0,7	1
71824	48,50	24	6,0	0,7	1
71826	53,30	26	6,0	0,7	1
71828	59,80	28	6,5	0,7	1

## Sartén VITROCOR

Poêle  
Pfanne  
Frying pan  
Sertã



Ref	€	Ø (cm)	h (cm)	e (mm)	U.Venta
40619	32,90	18	4,5	0,7	1
40621	35,00	20	4,5	0,7	1
40623	36,30	22	5,0	0,7	1
40625	38,80	24	5,2	0,7	1
40627	40,00	26	6,0	0,7	1
40629	42,90	28	6,5	0,7	1

non-stick  
coating  
scratch  
resistant



QuanTanium™  
Titanium-reinforced non-stick coating

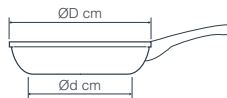

## Sartén antiadherente FOODIE

Poêle antiadherent  
Pfanne, Antihaft  
Frying-pan, non-stick  
Sertã anti-aderente

Ref	€	Ø (cm)	Ød (cm)	h (cm)	e (mm)	U.Venta
45320	36,60	20	13,5	5,5	0,6	1
45324	44,80	24	17,5	6,0	0,6	1
45328	53,70	28	19,5	6,5	0,6	1



## Sartén FOODIE

Poêle  
Pfanne  
Frying pan  
Sertã

Ref	€	Ø (cm)	Ød (cm)	h (cm)	e (mm)	U.Venta
45420	31,20	20	13,5	5,5	0,6	1
45424	37,20	24	17,5	6,0	0,6	1
45428	43,70	28	19,5	6,5	0,6	1

# Rustideras • Horno

Roasting pans • Oven



# Rustideras INOX 18/10

Inox  
18/10



Oven



Dishwasher



- Gran calidad, resistencia, tamaño y capacidad, muy útiles en la cocina.
- Ideales para la cocción de platos y asados al horno.
- Soportan sin problemas temperaturas altas.
- Excelente resistencia a la corrosión y a los ácidos alimentarios y sales.
- Asas atérmicas.

- Grande qualité, robustesse, taille et capacité, très utiles dans la cuisine.
- Idéal pour la cuisson de plats et de rôtis au four.
- Supporte sans problèmes des températures élevées.
- Excellente résistance à la corrosion et aux sels et acides alimentaires.
- Poignées athermiques.

- Qualität, Widerstandsfähigkeit, Größe und Fassungsvermögen auf hohem Niveau. Ein sehr praktischer Küchenhelfer.
- Ideal für Gerichte und Braten aus dem Ofen.
- Hält hohen Temperaturen problemlos stand.
- Sehr korrosionsbeständig und widerstandsfähig gegen Säure aus Lebensmittel und Salzen.
- Hitzeabweisende Griffe.

- Great quality, durability, size and capacity, very useful in the kitchen.
- Ideal for cooking dishes and roasts in the oven.
- Easily withstands high temperatures.
- Excellent resistance to corrosion and to food acids and salts.
- Heat-resistant handles.

- Ótima qualidade e resistência, grande tamanho e capacidade, muito útil na cozinha.
- Ideais para a elaboração de pratos e de assados no forno.
- Suportam temperaturas elevadas sem problemas.
- Excelente resistência à corrosão e aos ácidos e sais alimentares.
- Asas atérmicas.

Rustideras / Horno  
Roasting / Oven

## Rustidera

Plat à rotir  
Lasagneform  
Roaster  
Assadeira



## Rustidera CHEF-INOX

Plat à rotir  
Lasagneform  
Roaster  
Assadeira

Ref	€	cm	h (cm)	U.Venta
62530	32,80	30x21	5,5	1
62535	43,30	35x26	5,5	1
62540	55,10	40x31	6,0	1

Ref	€	cm	h (cm)	e (mm)	U.Venta
50540	115,20	40x30	8,0	1,0	1
50550	152,60	50x40	8,0	1,0	1
50560	192,20	60x45	8,0	1,0	1
50570	219,60	70x45	9,5	1,0	1

Inox

## Rustidera asas abatibles

Plat à gratin anse tombante  
Bratpfanne mit Fallgriffen  
Roaster moving handles  
Assadeira asa abatível



## Rustidera honda asas abatibles

Plat à rotir anse tombante  
Bratpfanne mit Fallgriffen  
Roaster moving handles  
Assadeira funda asa abatível

Ref	€	cm	h (cm)	U.Venta
61530	15,90	30x22	5,0	1
61535	20,20	35x26	6,0	1
61540	25,80	40x28	6,5	1
61545	38,20	45x32	7,5	1
61550	71,10	50x36	8,0	1

Ref	€	cm	h (cm)	U.Venta
62530A	36,30	30x22	7,5	1
62535A	44,20	35x26	8,0	1
62540A	52,60	40x28	8,0	1
62545A	61,00	45x32	9,0	1



# Rustideras ALUMINIO



## Asa de tubo de acero inoxidable 18/10

Handles in a 18/10 stainless steel tube

## Aluminio puro (99,5%)

Made in pure (99.5%) aluminium



- Cuerpo fabricado en aluminio.
- Asas y mangos atérmicos en tubo de acero inoxidable 18/10.
- Ideales para la cocción de platos y asados al horno.
- Apta para todos los tipos de cocina (excepto inducción).
- Máxima garantía en cuanto a resistencia, durabilidad e higiene.

- Corps fabriqué en aluminium.
- Poignées et manches athermiques en tube d'acier inoxydable 18/10.
- Idéal pour la cuisson de plats et de rôtis au four.
- Compatible avec tous les types de cuisinières (excepté l'induction).
- Garantie maximale en termes de résistance, de durabilité et d'hygiène.

## Rustidera con asas fijas

Plat à rotir anse fixe

Bratpfanne m. feststehenden Griffen

Roaster fix handle

Assadeira com asa fixa

Ref	€	cm	h (cm)	e (mm)	L	U.Venta
20540F	53,90	40x30	6,2	2,5	7,45	1
20545F	57,80	45x32	6,2	2,5	10,40	1
20550F	72,60	50x35	7,0	3,0	12,60	1
20555F	78,80	55x37	7,7	3,0	16,30	1
20560F	85,30	60x40	7,7	3,0	18,95	1
20565F	94,80	65x43	7,9	3,0	24,30	1
20570F	100,30	70x45	9,0	3,0	28,65	1

- Kessel aus reinem Aluminium.
- Griffe und Stiele aus hitzeabweisendem Edelstahlrohr 18/10.
- Ideal für Gerichte und Braten aus dem Ofen.
- Für alle Herdarten geeignet (außer Induktion).
- Garantiert robust, langlebig und hygienisch.

- Body made in aluminium.
- Heatproof handles and grips in a 18/10 stainless steel tube.
- Ideal for cooking dishes and roasts in the oven.
- Suitable for all types of cooking surfaces (except induction).
- Maximum guarantee in terms of resistance, durability and hygiene.

- Corpo fabricado em alumínio.
- Asas e mangos térmicos em tubo de aço inoxidável 18/10.
- Ideais para a elaboração de pratos e de assados no forno.
- Apta para todos os tipos de fogões (exceto placas de indução).
- Máxima garantia de resistência, durabilidade e higiene.

## Aluminio puro (99,5%)

Made in pure (99.5%) aluminium



## Rustidera con asas abatibles

Plat à rotir anse tombante

Bratpfanne mit Fallgriffen

Roaster moving handle

Assadeira com asa abatível

Ref	€	cm	h (cm)	e (mm)	L	U.Venta
20540A	53,90	40x30	6,2	2,5	7,45	1
20545A	57,80	45x32	6,2	2,5	10,40	1
20550A	72,60	50x35	7,0	3,0	12,60	1
20555A	78,80	55x37	7,7	3,0	16,30	1
20560A	84,70	60x40	7,7	3,0	18,95	1
20565A	94,80	65x43	7,9	3,0	24,30	1
20570A	100,30	70x45	9,0	3,0	28,65	1

## Tapa de cristal rustidera

Couvercle en verre pour plat à rôtir

Deckel Glas für Bratpfanne

Lid glass for roaster

Tampa de vidro para assadeira

Ref	€	cm	h (cm)	U.Venta
25539	14,60	34x28	8	1

\* Para la rustidera 25534 · For the 25534 roaster



Fondo Full Induction  
Full Induction bottom



## Rustidera Robust antiadherente c/asas abatibles

Plat à rotir Robust anse tombante, antiadherent

Bratpfanne Robust mit Fallgriffen, Aluminium, Antihaft

Roaster Robust moving handle, non-stick

Assadeira Robust com asa abatível anti-aderente

Ref	€	cm	h (cm)	U.Venta
23540A	61,60	40x30	6,2	1
23550A	75,00	50x35	7,0	1

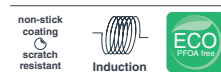

## Rustidera aluminio fundido antiadherente

Plat à gratin en aluminium fondu, antiadherent

Bratpfanne, Aluminium, Antihaft

Aluminium cast roaster, non-stick

Assadeira alumínio fundido anti-aderente

Ref	€	cm	h (cm)	U.Venta
25534	60,40	34x28	8	1

# Rustideras INTENSE

new



- Rustidera fabricada en aluminio de máxima calidad.
- Distribución homogénea del calor por toda la superficie.
- Recubrimiento antiadherente de gran calidad, resistente a arañazos y ralladuras.
- Ecológico, libre de materiales tóxicos y pesados. Libre de PFOA.
- Acabado interior y exterior en negro mate.
- Robusta y resistente a la deformación y a la abrasión.
- Ideal para hornear y gratinar todo tipo de alimentos.
- Aptas hasta 240°C.
- Asas diseñadas para un agarre seguro y cómodo.
- Fácil de limpiar.

- Plat à rôtir fabriqué en aluminium de la plus grande qualité.
- Distribution homogène de la chaleur sur toute la surface.
- Revêtement antiadhésif de grande qualité, résistant aux rayures.
- Écologique, sans matériaux toxiques ni métaux lourds. Sans PFOA.
- Finition intérieure et extérieure noir mat.
- Robuste et résistant à la déformation et à l'abrasion.
- Idéal pour une utilisation au four et pour gratiner tout type d'aliments.
- Résistant à des températures jusqu'à 240°C.
- Poignées conçues pour une prise en mains sûre et pratique.
- Facile à nettoyer.

- Bratpfanne aus Aluminium bester Qualität.
- Gleichmäßige Wärmeverteilung auf der gesamten Fläche.
- Hochwertige Antihafbeschichtung, abrieb- und kratzfest.
- Umweltfreundlich, frei von Giftstoffen und Schwermetallen. Ohne PFOA.
- Außen- und Innenseite in Mattschwarz.
- Strapazierfähig, formbeständig, abriebfest.
- Ideal zum Backen und Überbacken allerlei Lebensmittel.
- Temperaturbeständig bis 240° C.
- Griffe bieten festen und bequemen Halt.
- Leichte Reinigung.

- The roasting tin is made of top quality aluminium.
- Heat is distributed evenly over the entire surface.
- It has a high quality non-stick coating that is scratch and scrape resistant.
- It's environmentally friendly and free of toxic materials and heavy metals. It's PFOA free.
- The inside and outside have a matte black finish.
- It's sturdy and resists warping and scratches.
- It's perfect for baking and cooking all kinds of foods au gratin.
- Can be used up to 240° C.
- The handles are designed for a safe and comfortable grip.
- It's easy to clean.

- Assadeira fabricada em alumínio da máxima qualidade.
- Distribuição homogénea do calor por toda a superfície.
- Revestimento antiaderente de grande qualidade, resistente a riscos e raspões.
- Ecológica, não contém materiais tóxicos e pesados. Não contém PFOA.
- Acabamento interior e exterior em negro mate.
- Robusta e resistente à deformação e à abrasão.
- Ideal para assar e gratinar todo o tipo de alimentos.
- Resistente a temperaturas até 240 °C.
- Asas que permitem uma sujeição segura e cómoda.
- Fácil de limpar.



## Rustidera antiadherente INTENSE

Plat à rotir antiadherent  
Lasagneform, Antihaf  
Non-stick roaster  
Assadeira anti-aderente

Ref	€	cm	h (cm)	e (mm)	U.Venta
15720	14,20	20x15	4,7	1,50	1
15725	16,90	25x19	5,0	1,95	1
15730	22,80	30x22	5,7	3,00	1
15735	30,80	35x26	6,3	4,50	1

# PARRILLAS · PLACAS para horno



Inox

## Parrilla

Grille  
Gitter, Rost  
Grate  
Grelha

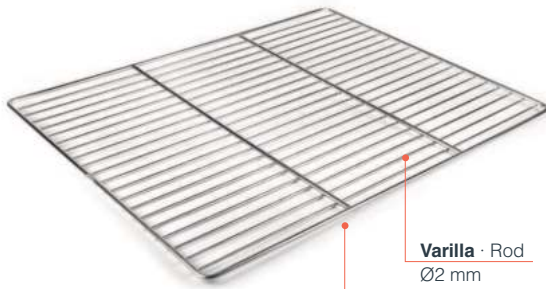

Varilla · Rod  
Ø2 mm

Varilla · Rod  
Ø5 mm

Ref	€	cm	h (cm)	U.Venta
68741	29,80	60x40	0,8	1

Inox

## Parrilla

Grille  
Gitter, Rost  
Grate  
Grelha

Varilla · Rod  
Ø6 mm



Varilla · Rod  
Ø3 mm

Ref	€	cm	Cubeta	U.Venta
66920	53,60	65X53	2/1	1
66921	20,60	53X32,5	1/1	1

AL

Aluminium



## Placa horno aluminio antiadherente

Plaque à four aluminium anti-adhesif teflon  
Backblech, Aluminium, Teflon  
Teflon non-stick coated oven aluminium tray  
Placa forno alumínio anti-aderente

Ref	€	cm	h (cm)	U.Venta
68660	37,20	60x40	1,0	1
68659	33,80	GN 1/1	1,0	1

Fe

Hierro/Iron



## Placa horno acero negro

Plaque à four tole noire  
Backblech, Schwarzstahl  
Baking sheet black steel  
Placa de forno aço negro

Ref	€	cm	h (cm)	U.Venta
68640	36,60	60x40	0,8	1

Inox

## Placa horno

Plaque à four  
Backblech  
Baking sheet  
Placa de forno



Ref	€	cm	h (cm)	U.Venta
68740	44,20	60x40	0,8	1
68739	34,20	GN 1/1	0,8	1

AL

Aluminium



## Placa horno

Plaque à four  
Backblech  
Baking sheet  
Placa de forno

Ref	€	cm	h (cm)	U.Venta
68641	34,70	60x40	0,8	1
68642	28,00	GN 1/1	0,8	1

# Pinzas para HORNO



## Pinza para horno y bandeja GN

Pince inox pour bac Gastronorm  
Zange für GN Behälter  
Tong GN tray  
Pinça para forno e bandejas GN



	Ref	€	L (cm)	U.Venta
A	62989	17,00	20	12
B	62998	17,00	20	12

Con silicona · With silicone

# CORDEL · TAPETES · LÁMINAS para horno



80  
m

## Rayón

Rayon

### Cordel cocina

Fil de cuisine  
Küchenschnur  
Kitchen string  
Fio de cozinha



**Bridar, albardar, atar asados y rellenos**  
Tying, wrapping and trussing roasts and stuffing

- Fabricado en rayón.
- Para bridar, albardar, atar asados y rellenos.
- Con soporte de almacenaje.
- Apto para horno. Temperatura max. 230°C

- Fabriqu  en rayonne.
- Pour ficeler, barder, attacher les r tis et les aliments farcis.
- Avec support de stockage.
- Convient pour le four. Temp rature max. 230°C

- Made of Rayon.
- For tying, wrapping and trussing roasts and stuffing.
- With storage support.
- Oven safe. max temperature 230°C.

Ref	€	m	U.Venta
61414	6,00	80	6

### Incluye - Includes:

- 1.- Tablas de conversi n de temperatura ( C /  F)
- 2.- Peso (gr / oz)
- 3.- Volum n ml / floz / pt)
- 4.- Longitud (mm / inch)
- 5.- Reglas laterales (cm / inch)

**Flexible, antiadherente y reutilizable**  
Flexible, non-stick and reusable

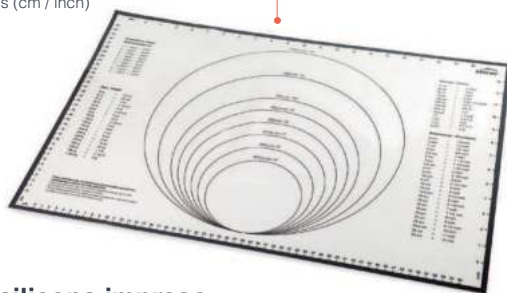

**Flexible, antiadherente y reutilizable**  
Flexible, non-stick and reusable

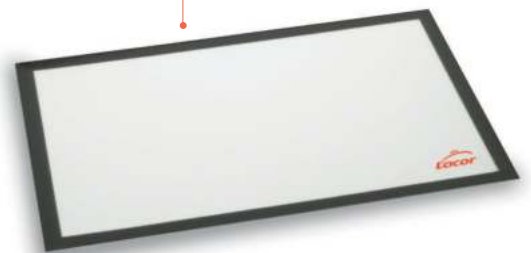

## Tapete de silicona impreso

Tapis en silicone imprime  
Bedruckte Silikonmatte  
Printed silicon mat  
Tapete de silicone impreso

Ref	€	cm	U.Venta
66759	28,90	60x40	1

## Tapete de silicona

Tapis en silicone  
Backblech-Auflage Silikon  
Silicone covering  
Tapete de silicone

Ref	€	cm	U.Venta
66749	20,30	30x40	1
66731	28,10	60x40	1
66732	20,80	52x32 GN 1/1	1



**Permite hornear sin necesidad de utilizar papel de horno**  
Lets you bake without having to use oven paper



## L minas antiadherentes

Feuilles antiadh sif  
Antihft-Bl tter  
Non-stick sheets  
L minas antiaderentes

Ref	€	cm	unidades	U.Venta
66746	9,80	30x40	3	1



- L minas de fibra de vidrio con recubrimiento antiadherente de gran calidad.
- Ideal para colocar sobre bandejas o parrillas de hornos y deshidratadores.
- Vida  til aproximadamente de 1000 hornados.
- Dise adas para soportar temperaturas de hasta 250 C.
- Recortable para adaptar a cualquier recipiente.
- Reutilizables, para una correcta conservaci n se recomienda su lavado a mano.
- No aptas para el lavavajillas.

- Fibreglass sheets with non-stick coating high-quality.
- Ideal for placing on baking trays, oven racks and dehydrators.
- Can be used approximately 1,000 times.
- Designed to withstand temperatures up to 250 C.
- Can be cut to fit any container.
- Reusable; in order to keep the sheets in good condition, we recommend washing by hand.
- Non-dishwasher safe.

# Colección PARIS · MILAN · LIMA

new



## GUANTES · MANOPLAS · DELANTALES

- Permiten manipular todo tipo de utensilios de cocina con total seguridad.
- Combinan la resistencia al calor con la flexibilidad y comodidad del algodón.
- Guantes con manga que cubre la mayor parte del antebrazo.
- Práctica presilla para colgarlo en la cocina.
- Delantales de gran calidad con bolsillo inferior dividido en dos partes. Unisex. Talla única ajustable.

## KITCHEN GLOVES · OVEN MITTS · APRONS

- For safely handling all types of kitchen utensils.
- Perfectly heat resistant together with the flexibility and comfort of cotton.
- Gloves featuring a sleeve that covers most of the forearm.
- Practical clip for hanging in the kitchen.
- Top-quality aprons featuring a bottom pocket divided into two parts. Unisex. One size fits all (adjustable).

## Personalización para cantidades

Personnalisation pour des quantités  
Individuelle Gestaltung bei Abnahme  
Customization for quantities  
Personalização para quantidades

>500 ud.

## Delantal de algodón

Tablier en coton  
Schürze, Baumwolle  
Cotton pinafore  
Avental de algodão

Ref	€	U.Venta
10004	12,00	1



Paris  
Collection



## Delantal

Tablier  
Schürze  
Pinafore  
Avental

Ref	€	cm	U.Venta
60080	13,50	68x83	1

Milan  
Collection



## Delantal

Tablier  
Schürze  
Pinafore  
Avental

Ref	€	cm	U.Venta
60081	11,20	68x83	1

Lima  
Collection



## Delantal

Tablier  
Schürze  
Pinafore  
Avental

Ref	€	cm	U.Venta
60082	8,90	68x83	1

## Guante de cocina

Gant du cuisine  
Küchenhandschuh  
Kitchen glove  
Luva de cozinha



Ref	€	L (cm)	U.Venta
60037	5,50	30	1

## Guante de cocina

Gant du cuisine  
Küchenhandschuh  
Kitchen glove  
Luva de cozinha



Ref	€	L (cm)	U.Venta
60038	5,00	30	1

## Guante de cocina

Gant du cuisine  
Küchenhandschuh  
Kitchen glove  
Luva de cozinha



Ref	€	L (cm)	U.Venta
60039	4,70	30	1

## Manopla

Mouflette  
Fäustling  
Mitten  
Pega



Ref	€	cm	U.Venta
60044	4,30	20x20	1

## Manopla

Mouflette  
Fäustling  
Mitten  
Pega



Ref	€	cm	U.Venta
60045	3,90	20x20	1

## Manopla

Mouflette  
Fäustling  
Mitten  
Pega



Ref	€	cm	U.Venta
60046	3,50	20x20	1

# Colección **GUANTES DE COCINA**



- **Materiales de alta calidad y una alta protección contra el calor por contacto.**
- **Permite manipular todo tipo de utensilios de cocina con total seguridad.**
- **Combina la resistencia al calor con la flexibilidad y comodidad.**
- **Manga que cubre la mayor parte del antebrazo.**

- Matériaux de grande qualité et une haute protection contre la chaleur pour contacts.
- Permet de manipuler tout type d'ustensiles de cuisine en toute sécurité.
- Allie la résistance à la chaleur à la flexibilité et le confort.
- Manche qui recouvre une grande partie de l'avant-bras.

- Hohe Materialqualität und Hitzeschutz per Kontakt.
- Absolut sichere Handhabung sämtlicher Küchengeräte.
- Hitzebeständiger, weicher und bequemer.
- Unterarmschutz.

- High quality materials and excellent heat protection by contact.
- Lets you handle all kinds of cooking utensils with complete safety.
- Combines heat resistance with flexibility and the comfort.
- The sleeve covers most of your forearm.

- Materiais de alta qualidade, que proporcionam uma boa proteção contra o calor por contato.
- Permite manipular todo o tipo de utensílios de cozinha com total segurança.
- Combina a resistência ao calor com a flexibilidade e a comodidade.
- Manga que cobre a maior parte do antebraço.

**SI**

Silicone



## Guante cocina textil+silicona

Gant de cuisine en cotton + silicone  
Küchenhandschuh aus Baumwolle + Silikon  
Gray kitchen cotton + silicone  
Luva de cozinha de algodão + silicone

Ref	€	L (cm)	U.Venta
61034	10,10	32	6



**SI**

Silicone



## Guante cocina algodón+silicona

Gant de cuisine silicone  
Küchenhandschuh, Silikon + Baumwolle, grau  
Gray kitchen silicone + cotton glove  
Luva de cozinha de algodão + silicone

Ref	€	L (cm)	U.Venta
61033	22,30	33	1



## Guante cocina textil

Gant de cuisine en cotton  
Küchenhandschuh aus Baumwolle  
Gray kitchen cotton  
Luva de cozinha de algodão

Ref	€	L (cm)	U.Venta
60070	12,50	36	1



## Guante algodón aluminizado

Gant de cuisine coton aluminisé  
Küchehandschuh, Baumwolle, Aluminisierte  
Aluminized cotton oven glove  
Luva de cozinha de algodão alumínio

	Ref	€	L (cm)	U.Venta
<b>A</b>	61024	6,00	24	1
<b>B</b>	61030	7,10	30	1
<b>C</b>	61036	7,70	36	1



# Guantes de cocina ORKA & ORKA-TEX



- Seguridad máxima: resistencia a las fuertes temperaturas.
- Presión asegurada: ranuras antideslizantes.
- Manejable: exterior del guante de silicona flexible. Forro interior de algodón amovible lavable (60041).
- Práctica anilla para colgar. Ambidiestro.
- Fácil de lavar y desinfectar.

- Sécurité maximum: résistance aux fortes températures.
- Préhension: sécurisée: rainures antidérapantes.
- Maniable: extérieur du gant en silicone flexible. Doublure en coton amovible (60041).
- Pratique anneau de suspension. Ambidextre.
- Facile à laver et désinfecter.

- Maximale Sicherheit: hitzebeständig.
- Sicherer Halt: rutschfeste vertiefungen.
- Einfache Handhabung: Außenseite des Handschuhs aus flexiblem Silikon. Herausnehmbares Baumwollfutter (60041).
- Praktisch: mit Ring zum Aufhängen. Beidhändig.
- Leicht zu reinigen und zu desinfizieren.

- Maximum safety: withstands extremely high temperatures.
- Safe grip: non-slip grooves.
- Easy to handle: exterior of the glove in flexible silicone. Removable cotton lining (60041).
- Practical hanging ring. Fits both hands.
- Easy to wash and disinfect.

- Segurança máxima: resistência às temperaturas elevadas.
- Pressão assegurada: ranhuras antideslizantes.
- Manejável: Exterior da luva em silicone flexível. Forro interior de algodão amovível e lavável (60041).
- Prática anilha para pendurar. Para pessoas ambidexas.
- Fácil de lavar e desinfetar.



## Guante de cocina ORKA

Gant de cuisine  
Küchenhandschuh  
Kitchen glove  
Luva de cozinha

	Ref	€	L (cm)	U.Venta
A	60010	37,10	29	1
B	60011	60,80	42	1

## Guante de cocina ORKA-TEX

Gant de cuisine  
Küchenhandschuh  
Kitchen glove  
Luva de cozinha

	Ref	€	L (cm)	U.Venta
	60041	31,20	29	12

# Guantes · Delantal de **PROTECCIÓN**

**Composición** · Composition:  
62% Polietileno / 62% Polyethylene  
24% Poliéster / 24% Polyester  
14% Fibra de vidrio / 14% Glass fiber

**2**

Unid.



## Guante protección

Gant de protection  
Schutzhandschuh  
Protection glove  
Luva de protecção

Ref	€	Talla	Medida	Perim. mano	L (cm)	U.Venta
61101	19,50	M	8	182 mm	24	1
61102	19,50	L	9	192 mm	25	1
61103	19,50	XL	10	204 mm	26	1

**Guantes certificados según regulación EPI EU 2016/425 módulo B**  
Gloves certified according to regulation EPI EU 2016/425 module B

**Ideal para uso en mandolinas profesionales**  
Ideal for use in professional mandolins



Inox

## Guante cota

Gant en maille  
Netz-Handschuh  
Chainman glove  
Luva de malha

Ref	€	Talla	Medidas	Perím. mano	Color	U.Venta
39169	139,10	S	7	171 mm	Blanco/White	1
39170	139,10	M	8	182 mm	Rojo/Red	1
39171	139,10	L	9	192 mm	Azul/Blue	1
39172	139,10	XL	10	204 mm	Naranja/Orange	1



Inox

## Delantal cota de malla

Tablier en maille  
Kettenhemb Schürze  
Metal butcher's apron  
Avental de malha

Ref	€	cm	Perímetro	U.Venta
39165	322,40	80x55	95-145 cm	1

· **Ambidiestros, cómodo y ligero.**  
· **NO emplear con sierras giratorias o dentadas.**

· Ambidextres, pratiques et légers.  
· NE PAS utiliser avec des scies giratoires ou dentées.  
· Beidhändig verwendbar, bequem und leicht.  
· NICHT mit Kreissägen oder gezahnten Sägen verwenden.

· Ambidextrous, comfortable and light.  
· Do NOT use with rotating or toothed saws.

· Ambidestro, cómodos e leves.  
· NÃO utilizar com serras giratórias ou dentadas.

**Resistencia a la abrasión** **3**  
Abrasion resistance

**Resistencia al corte** **4**  
Blade cut resistance

**Resistencia al PDM** **C**  
PDM resistance

**Resistencia al desgarro** **4**  
Tear resistance

EN 388:2016+1:2018



344 XC

CE certificate issued by CTC FRANCE

· **Guante cinco dedos con correa en la muñeca.**  
· **Reversible para mano derecha como izquierda.**  
· **Diseño de correa extraíble y protección completa de mano.**  
· **Fácil lavar y desinfectar.**

· Gant cinq doigts avec courroie au poignet.  
· Réversible pour main droite ou gauche.  
· Conception de courroie extractible et protection complète de la main.  
· Facile à laver et désinfecter.

· Fingerhandschuh mit Riemen am Handgelenk.  
· Für rechte und linke Hand wendbar.  
· Herausnehmbarer Riemen und vollständiger Handschutz.  
· Leicht zu reinigen und zu desinfizieren.

· Five-finger glove with strap on the wrist.  
· Reversible for both right and left hand.  
· Detachable strap and complete hand protection design.  
· Easy to wash and disinfect.

· Luva de cinco dedos com correia no punho.  
· Reversível, para a mão direita ou esquerda.  
· Design com correia extraível e proteção total da mão.  
· Fácil de lavar e desinfetar.



UNE EN 1082

CE Directive 89/686/EEC and EN 1082-1-1996

· **Ajustable gracias a sus tirantes verticales y horizontales.**  
· **Conviene asegurarse de que las medidas del cuchillo empleado no sean inferiores a:**

· Ajustable grâce à ses bandes verticales et horizontales.  
· Il convient de s'assurer que les dimensions du couteau utilisé ne sont pas inférieures à :

· Anpassbar, dank seiner vertikalen und horizontalen Feststellvorrichtung.  
· Sie sollten sich vergewissern, dass die Größen der verwendeten Messer nicht kleiner sind als:

· Adjustable thanks to its vertical and horizontal straps.  
· Care must be taken to ensure that the knife used does not measure less than:

· Ajustável graças aos seus tirantes verticais e horizontais.  
· É conveniente certificar-se de as dimensões da faca utilizada não serem menores de:

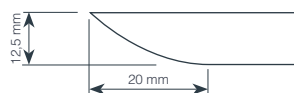

UNE EN 1082

EN ISO 13998: 2003  
NIVEL / LEVEL: 2



# PROTECTORES para mangos / asas



## Protector de silicona

Protection en silicone  
Silikonschutz  
Silicone handle cover  
Protector de silicone

Ref	€	L (cm)	U.Venta
23900	6,40	13,5	1



- Mango protector de silicona de alta calidad para sartenes.
- Fácil de colocar, se ajusta perfectamente al mango de la sartén.
- Antideslizante y termorresistente, protege de las temperaturas elevadas.
- Compatible con nuestras sartenes Robust, Ferrum, Dynamic y Tricapa Plus (Ø16-32 cm).

- Manche de protection en silicone de grande qualité pour poêles.
- Facile à installer, il s'adapte parfaitement au manche de la poêle.
- Antidérapant et thermorésistant, il protège des températures élevées.
- Compatible avec nos poêles Ferrum, Robust, Dynamic et Tricapa Plus (Ø16-32 cm).

- High quality protective silicone handle for frying pans.
- Easy to put on, it fits the pan handle perfectly.
- Non-slip and heat-resistant, it protects from high temperatures.
- Compatible with our Ferrum, Robust, Dynamic and Tricapa Plus frying pans (Ø16-32 cm).

## Manopla de silicona

Mouflette en silicone  
Fäustling aus Silikon  
Silicone mitten  
Pegas de silicone

Ref	€	U.Venta
60014	9,90	6



## Cubre asas ECO-PIEDRA

Couvrir les poignées  
Griffschutz  
Covers handles  
Pegas cobre-asas

Ref	€	Ø (cm)	U.Venta
R25436A	11,60	32-36-40	1



## Cubre asas TITANIUM

Couvrir les poignées  
Griffschutz  
Covers handles  
Pegas cobre-asas

Ref	€	Ø (cm)	U.Venta
R27520A	4,30	20	1
R27528A	4,40	24-28	1
R27732A	5,50	32-36	1



## Cubre asas

Couvrir les poignées  
Griffschutz  
Covers handles  
Pegas cobre-asas

Ref	€	Ø (cm)	U.Venta
R25917G	8,20	16	6
R25921G	7,80	20-24-28	6
R25933G	8,20	26x20	6
R25935G	7,80	31x25	6

## Asas para plancha grill

Poignées pour plaque à grill  
Griffschutz for Platte Grill  
Handles for grill plaque  
Asas para plancha grill

Ref	€	cm	U.Venta
R25536A	4,00	36	1
R25547A	5,60	47	1

## Asas para plancha grill

Poignées pour plaque à grill  
Griffschutz for Platte Grill  
Handles for grill plaque  
Asas para plancha grill

Ref	€	cm	U.Venta
R25736A	4,00	36	1
R25747A	5,60	47	1

# Relojes de COCINA



- Gracias a su parte posterior magnética podrá colocar el reloj de cocina en cualquier parte metálica de su cocina.
- Alarma acústica programable.

- Grâce à sa partie arrière magnétique, le minuteur peut être placé sur n'importe quelle partie métallique de la cuisine.
- Alarme acoustique programmable.

- Dank der magnetischen Rückseite kann die Küchenuhr an jede metalische Oberfläche in Ihrer Küche angebracht werden.
- Programmierbarer akustischer alarm.

- Thanks to the magnet on the back, the kitchen timer can be placed on any metal surface in the kitchen.
- Programmable acoustics alarm.

- Graças à sua parte posterior magnética, poderá colocar o relógio de cozinha em qualquer parte metálica da sua cozinha.
- Alarme sonoro programável.

Magnético  
Magnet



## Reloj de cocina magnético

Minuteur de cuisine magnetique  
Magnetküchentimer  
Magnetic kitchen timer  
Relógio de cozinha magnetico

Ref	€	Tiempo	cm	U.Venta
60803	10,80	60 min	9,2x3,5	1

Magnético  
Magnet



## Reloj digital de cocina con avisador acústico

Minuter Électronique  
Digitale Küchen-Zeitschaltuhr mit Alarm  
Digital kitchen timer w/alarm  
Relógio digital de cozinha com alarme acústico

Ref	€	cm	U.Venta
60805	9,00	10,5x7	1

new

24 23h 59 min 59 seg  
Horas/Hours



Soporte plegable  
con potente imán  
Folding stand with  
powerful magnet

## Reloj de cocina con alarma

Minuteur de Cuisine avec Alarme  
Küchen-Zeitschaltuhr mit Alarm  
Kitchen Timer Alarm  
Relógio de cozinha com alarme

Ref	€	cm	U.Venta
60802	19,60	7x1,4x5,1	1

Magnético  
Magnet  
Resistente al agua (IP65)  
Water resistance



12/24 99:99:99  
Horas/Hours

## Reloj de cocina con alarma

Minuteur de Cuisine avec Alarme  
Küchen-Zeitschaltuhr mit Alarm  
Kitchen Timer Alarm  
Relógio de cozinha com alarme

Ref	€	cm	U.Venta
60804	38,90	13x24,5x2,5	1

# Paelleras

Paella pans



# Paelleras INOXIDABLES

Inox  
18/10



Sandwich

Vitro

Electric

Gas

Induction

Oven

Dishwasher

## Paellera con tapa CHEF-LUXE

Plat rond avec couvercle  
Pfanne mit Deckel  
Round dish with lid  
Paelheira com tampa

Ref	€	Ø (cm)	h (cm)	e (mm)	L	U.Venta
54636	169,50	36	7,0	1,5	7,00	1
54640	206,30	40	8,0	1,5	10,00	1
54645	238,90	45	8,5	2,0	12,00	1
* 54650	301,50	50	9,0	2,0	17,00	1

\* NO inducción · NOT induction

## Paellera s/tapa CHEF-LUXE

Plat rond s/couvercle  
Pfanne ohne Deckel  
Round dish without lid  
Paelheira sem tampa

Ref	€	Ø (cm)	U.Venta
54636S	134,10	36	1
54640S	166,30	40	1
54645S	193,00	45	1
* 54650S	246,80	50	1

\* NO inducción · NOT induction



## Paellera con tapa CHEF-CLASSIC

Plat rond a/couvercle  
Pfanne mit Deckel  
Round with lid  
Paelheira com tampa

Ref	€	Ø (cm)	h (cm)	e (mm)	L	U.Venta
50624	63,00	24	6,0	0,8	2,70	1
50628	85,20	28	6,0	0,8	3,60	1
50632	110,20	32	6,0	0,8	5,00	1
50636	139,30	36	7,0	1,0	7,10	1
50640	160,60	40	8,0	1,0	10,00	1
50645	188,60	45	8,5	1,0	13,50	1
50650	244,60	50	9,0	1,0	17,60	1
* 50660	353,80	60	9,0	1,0	25,40	1

\* NO inducción · NOT induction

## Paellera s/tapa CHEF-CLASSIC

Plat rond s/couvercle  
Pfanne ohne Deckel  
Round dish without lid  
Paelheira sem tampa

Ref	€	Ø (cm)	U.Venta
50624S	48,30	24	1
50628S	68,40	28	1
50632S	87,80	32	1
50636S	112,50	36	1
50640S	130,20	40	1
50645S	152,30	45	1
50650S	200,10	50	1
* 50660S	295,50	60	1

\* NO inducción · NOT induction



## Paellera sin tapa ECO-CHEF

Plat rond sans couvercle  
Pfanne ohne Deckel  
Round without lid  
Paelheira sem tampa

Ref	€	Ø (cm)	h (cm)	e (mm)	L	U.Venta
57624	40,10	24	6,5	0,8	3,00	1
57628	55,50	28	6,5	0,8	4,00	1
57632	70,90	32	7,0	0,8	5,00	1
57636	93,70	36	7,0	1,0	7,10	1
57640	108,00	40	8,0	1,0	10,00	1



## Paellera sin tapa WAGNER

Plat rond s/couvercle  
Pfanne ohne Deckel  
Round dish without lid  
Paelheira sem tampa

Ref	€	Ø (cm)	h (cm)	e (mm)	L	U.Venta
50624W	50,70	24	6,0	0,8	2,70	1
50628W	67,30	28	6,0	0,8	3,60	1
50632W	83,50	32	6,0	0,8	5,00	1
50636W	113,50	36	7,0	1,0	7,10	1
50640W	129,80	40	8,0	1,0	10,00	1
50645W	149,50	45	8,5	1,0	13,50	1
50650W	202,20	50	9,0	1,0	17,60	1
* 50660W	288,00	60	9,0	1,0	25,40	1

\* NO inducción · NOT induction





### Paellera Valenciana antiadherente

Plat à paella anti-adhesif  
 Paellapfanne, Antihaf  
 Round dish for paella non-stick  
 Paelheira valenciana anti-aderente

Ref	€	Ø (cm)	Raciones	U.Venta
60228	66,50	28	3	1
60232	77,00	32	5	1
60236	91,00	36	7	1
60240	110,00	40	9	1



### Paellera Valenciana

Plat à paella  
 Paellapfanne  
 Round dish for paella  
 Paelheira valenciana

Ref	€	Ø (cm)	Raciones	U.Venta
60130	61,80	30	4	1
60134	74,40	34	6	1
60138	88,50	38	8	1
60142	108,10	42	10	1
60146	128,50	46	12	1
60150	166,40	50	14	1
60155	211,80	55	16	1
60160	263,30	60	18	1

Mantiene el diseño  
 de las paelleras clásicas y elegantes  
 Maintains the classic and elegant  
 paella pan design

Asas con baño dorado  
 Golden bath handles



# Paelleras ALUMINIO



**Full Induction**  
TOTAL



Incluye asas de silicona  
Includes silicone handles



## Paellera ECO-PIEDRA BLACK

Plat à paella  
Pfanne  
Round dish  
Paelheira

Ref	€	ØD (cm)	Ød (cm)	h (cm)	Raciones	e (mm)
25432	74,50	32	25,5	4,5	5	1,6
25436	79,70	36	29,5	4,5	7	2,0
25440	93,00	40	33,5	4,5	9	2,0

**Si**

Silicone

## Asas para paellera ECO-PIEDRA

Poignées pour plat rond  
Griffschutz for Pfanne  
Handles for round dish  
Asas para paelheira



Ref	€	Ø (cm)	U.Venta
R25436A	11,60	32-36-40	1

**Full Induction**  
TOTAL



Revestimiento antiadherente  
**Xylan Plus**  
Nonstick coating

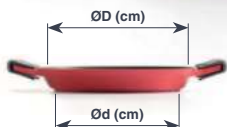

Incluye asas de silicona  
Includes silicone handles

## Paellera COCOTTE

Plat rond  
Pfanne  
Round  
Paelheira

Ref	€	ØD (cm)	Ød (cm)	h (cm)	e (mm)	Raciones	U.Venta
25932	82,10	32	25,5	4,5	1,6	5	1
25936	95,90	36	29,5	4,5	2,0	7	1
25940	106,60	40	33,5	4,5	2,0	9	1

- Fabricadas en aluminio fundido de gran calidad y espesor, reforzadas con partículas a base de piedra y una máxima resistencia al rayado, duración y desgaste.
- Distribución homogénea del calor, permitiendo que los alimentos se cocinen rápidamente y de manera uniforme, sin apenas utilizar aceite.
- Antiadherente TRlcapa de máxima calidad y ecológico. Libre de PFOA.
- Fácil limpieza interior y exterior gracias a protección antiadherente.
- Aptas para todo tipo de fuegos y se puede lavar en el lavavajillas.
- Asas fabricadas en silicona de máxima calidad, termoaislantes, altamente resistentes y ergonómicas, permiten un agarre seguro en la pieza.

- Fabriquées en fonte d'aluminium de grande qualité et épaisseur, elles sont renforcées par particules à base de pierre et confère une résistance maximale aux rayures et à l'usure pour allonger la durée de vie.
- Distribution homogène de la chaleur, permettant aux aliments de se cuire rapidement et de façon uniforme, sans à peine utiliser d'huile.
- Antiadhésif Tri-couche d'une qualité maximale et écologique, est sans PFOA.
- Intérieur et extérieur faciles à nettoyer grâce à la protection antiadhésive
- Compatibles avec tout type de feux et peuvent être lavées au lave-vaisselle.
- Poignées fabriquées en silicone de la plus grande qualité, thermo-isolantes, hautement résistantes et ergonomiques, qui permettent de tenir l'ustensile en toute sécurité.

- Made in high quality and thickness cast aluminium, it is reinforced with stone-based particles and maximum scratch and wear resistance and durability.
- Allows for a homogeneous heat distribution, allowing the food to cook quickly and uniformly, without barely any oil.
- Its high quality and eco-friendly non-stick coating TRlcapa is PFOA-free.
- Easy to clean interior and exterior with its non-stick protection.
- Suitable for all range cookers and they are dishwasher safe.
- Heat insulating, highly resistant, ergonomic handles made of high quality silicone which provide a secure grip on pots and pans.

new

- Fabricadas en aluminio fundido.
- Garantizan la absorción y distribución uniforme del calor, sin puntos de sobrecalentamiento.
- La distribución del calor uniforme por toda la pieza hace que los alimentos no pierdan su jugo durante la cocción, conservando así todos sus nutrientes y vitaminas.
- Fondo difusor FULL INDUCTION; asegura un rendimiento óptimo en todo tipo de cocinas, con un reparto de calor inmejorable logrando la máxima eficiencia y ahorro de energía.
- Perfectas para arroces, carnes, pescados, legumbres, verduras, guisos, cremas, salsas, sopas, etc.
- Revestimiento antiadherente Xylan Plus.
- Diseño atractivo y funcional.
- Compatibles con todo tipo de cocinas, incluida la inducción.

- Fabriquées en fonte d'aluminium.
- Garantit l'absorption et la distribution uniforme de la chaleur, sans points de surchauffe.
- La répartition uniforme de la chaleur dans toute la pièce signifie que les aliments ne perdent pas leur jus pendant la cuisson, préservant ainsi tous leurs nutriments et vitamines.
- Fond diffuseur FULL INDUCTION; garantit un rendement optimal sur tout type de feux, avec une répartition de la chaleur unique, obtenant ainsi une efficacité et une économie d'énergie maximales.
- Parfait pour le riz, la viande, le poisson, les légumineuses, légumes, ragoûts, crèmes, sauces, soupes, etc.
- Revêtement antiadhésif Xylan Plus.
- Conception attrayante et fonctionnelle.
- Compatible avec tout type de feux, y compris l'induction.

- Made in cast aluminium.
- It guarantees the absorption and uniform distribution of heat, without overheating points.
- The uniform distribution of heat throughout the product makes keep its juices during cooking, preserving all its nutrients and vitamins.
- The FULL INDUCTION diffuser bottom ensures optimal performance on all kinds of cookers with unbeatable heat distribution that achieves maximum efficiency and energy savings.
- Ideal product for: rice, meats, fish, beans, vegetables, stews, creams, sauces, soups, etc.
- Non-stick coating Xylan Plus.
- Attractive design and great functionality.
- It's compatible with all kinds of cookers, including induction.



### Paellera CHEF-ALUM.

Plat rond  
Pfanne  
Round  
Paelheira

Ref	€	Ø (cm)	h (cm)	e (mm)	L	U.Venta
20628	41,80	28	7,0	2,5	4,30	1
20630	44,40	30	6,5	2,5	4,75	1
20632	47,50	32	7,0	2,5	5,50	1
20634	50,20	34	7,0	2,5	6,35	1
20636	53,10	36	7,5	2,5	7,45	1
20638	53,90	38	7,5	2,5	8,60	1
20640	63,40	40	8,0	3,0	10,05	1
20645	69,30	45	8,0	3,0	12,50	1
20650	80,80	50	8,0	3,5	15,50	1
20660	115,50	60	10,0	4,5	28,00	1



### Paellera ROBUST

Plat rond  
Paellapfanne  
Round dish  
Paelheira



Ref	€	Ø (cm)	h (cm)	U.Venta
23724	22,80	24	4,00	1
23728	29,90	28	4,50	1
23732	35,20	32	5,00	1
23736	42,50	36	5,50	1
23740	52,60	40	6,00	1

## Paelleras MASTER



### Paellera STEEL PRO

Plat à paella  
Paellapfanne  
Round dish for paella  
Paelheira

Ref	€	Ø (cm)	Raciones	U.Venta
63621	6,70	20	1	6
63623	6,80	22	1	6
63625	7,10	24	1	6
63627	7,80	26	2	6
63629	8,10	28	3	6
63631	8,80	30	4	6
63633	9,80	32	5	6
63635	10,60	34	6	6
63637	11,40	36	7	1
63639	12,80	38	8	1
63641	13,90	40	9	1
63643	16,00	42	10	1
63647	18,00	46	12	1
63651	21,40	50	14	1
63656	35,00	55	16	1
63661	41,40	60	19	1
63666	51,30	65	22	1
63671	73,00	70	25	1
63681	100,30	80	40	1
63691	140,10	90	50	1
63115	417,60	115	120	1
63130	867,10	130	200	1

Con 4 asas  
With 4 handles  
Con 6 asas  
With 6 handles

- Clásicas paelleras fabricadas en acero.
- Máxima garantía en cuanto a resistencia, durabilidad e higiene.
- Ideales para eventos, catering y fiestas populares.
- Apts para cocina de gas, vitrocerámica, eléctrica.
- Disponible en diferentes diámetros.

- Poêles à paella classiques en acier.
- Garantie maximale en termes de résistance, durabilité et hygiène.
- Idéal pour les événements, la restauration et les fêtes populaires.
- Convient aux cuisinières à gaz, vitrocéramiques et électriques.
- Disponible en différents diamètres.

- Classic paella pans made of steel.
- Maximum guarantee in terms of resistance, durability and hygiene.
- Ideal for events, catering and popular parties.
- Suitable for Gas, Vitroceramic, Electric cookers.
- Available in different diameters.

Asas de acero inoxidable  
Stainless steel handles



### Paellera FERRUM

Plat à paella  
Paellapfanne  
Round dish for paella  
Paelheira

Ref	€	Ø (cm)	h (cm)	e (mm)	Raciones	U.Venta
63928	57,10	28	4,5	2,5	3	1
63932	64,70	32	4,7	2,5	5	1
63936	80,70	36	5,5	2,5	7	1
63940	88,90	40	5,5	2,5	9	1



### Paellera antiadherente STEEL

Plat à paella, antiadhesive  
Paellapfanne, Antihaf  
Round dish for paella, non stick  
Paelheira anti-aderente

Ref	€	Ø (cm)	Raciones	U.Venta
60127	21,80	28	3	1
60131	24,60	32	5	1
60135	28,50	36	7	1
60139	32,00	40	9	1
60144	42,70	45	12	1
60149	51,60	50	14	1
60159	65,40	60	19	1

**Esmalte vitrificado**  
Vitrified enamel



### Paellera SMALT

Plat à paella  
Paellapfanne, emailiert  
Round dish for paelle  
Paelheira esmaltada

Ref	€	Ø (cm)	Raciones	U.Venta
60170	5,10	10	1	10
60172	5,70	12	1	10
60175	6,70	15	1	6
60180	8,60	20	1	6
60184	10,40	24	1	1
60188	12,70	28	3	1
60182	17,40	32	5	1
60186	19,50	36	7	1
60141	24,00	40	9	1
60151	36,80	50	14	1
60161	57,90	60	19	1

## Accesorios para PAELLERAS

Diseñado para el soporte paellero ref. 63700  
Designed for base for burner



### Paellero Gas Butano

Rechaud  
Brenner  
Burner  
Paelheira gás butanos

Ref	€	Ø (cm)	Quemadores	Kw	Presión (mbar)	U.Venta	Paelleras recomendadas
63731	46,70	30	1	6,50	37	1	Ø36-38-40-42-46
63741	80,80	20-40	2	11,40	37	1	Ø28-30-32-34-36-46-50-55
63751	106,80	30-50	2	14,10	37	1	Ø38-40-42-46-60-65-70
63761	150,40	20-40-60	3	21,00	37	1	Ø28-30-32-34-36-46-50-55-70-80
63771	247,20	30-50-70	3	24,50	37	1	Ø38-40-42-46-60-65-70-80-90

Válido para propano y butano · NO válidas Gas Natural y Gas Ciudad  
Valid for propane and butane · NOT valid Natural Gas and Gas City

Regulable para distintas medidas  
Adjustable for different measures



### Soporte paellero

Pied pour rechaud  
Stände für Brenner  
Base for burner  
Cuporte paelheria

Ref	€	U.Venta
63700	46,30	1



# Utensilios

Utensils





**Juegos de cocina**  
Kitchen tools

**Preparación**  
Food processing

**Básculas · Termómetros**  
Scales · Thermometers

# Colección U.P.

Inox



Dishwasher

## Cacillo perforado

Louche perforée  
Schöpfkelle, gelocht  
Perforated ladle  
Concha perforada

Ref	€	Ø (cm)	L (cm)	L	U.Venta
61308	11,00	8	38,0	0,12	6
61310	14,20	10	46,0	0,25	6
61312	16,90	12	48,0	0,50	1



## Cacillo

Louche  
Schöpfkelle  
Ladle  
Concha

Ref	€	Ø (cm)	L (cm)	L	U.Venta
60306	10,20	6,50	34,5	0,07	6
60308	11,70	8,00	38,0	0,12	6
60309	12,40	9,00	46,0	0,20	6
60310	14,00	10,00	46,0	0,25	6
60312	16,40	12,00	48,0	0,50	6
60314	21,10	14,00	55,0	0,75	6
60316	21,80	16,00	55,5	1,00	6



## Cuchara lisa

Cuillère lisse  
Servierlöffel  
Spoon  
Colher lisa

Ref	€	Ø (cm)	L (cm)	U.Venta
60507	11,00	10,5	48,0	1



## Cuchara perforada

Cuillère perforée  
Servierlöffel, gelocht  
Perforated spoon  
Colher perforada

Ref	€	Ø (cm)	L (cm)	U.Venta
60508	13,30	7,50	48,0	6



## Espátula lisa

Spatule lisse  
Backschaufel  
Spatula  
Espátula lisa

Ref	€	cm	L (cm)	U.Venta
61410	12,30	9x10	49,5	6
61412	13,90	11x12	51,0	6



## Espátula perforada

Spatule perforée  
Backschaufel, gelocht  
Perforated spatula  
Espátula perforada

Ref	€	cm	L (cm)	U.Venta
61411	13,20	9x10	49,50	6
61413	14,40	11x12	51,0	6



## Espumadera

Ecumoire  
Schaumlöffel  
Skimmer  
Escumadeira

Ref	€	Ø (cm)	L (cm)	U.Venta
60408	9,70	8	35,0	1
60410	11,70	10	47,0	6
60412	12,30	12	49,5	6
60414	16,40	14	57,0	6
60416	18,00	16	57,0	6



## Paleta de pescado Profesional

Pelle à poisson Professionnel  
Fischheber, professional  
Professional long fish turner  
Espátula de peixe professional

Ref	€	cm	L (cm)	U.Venta
62988	19,90	20,5x8	37,0	12



## Cuchara oblicua

Cuillère oblique  
Giesslöffel, quer  
Crosswire spoon  
Colher oblíqua

Ref	€	cm	L (cm)	ml	U.Venta
60509	14,40	8x10	345,0	70	1



## Tenedor

Fourchette  
Tranchiergabel  
Fork  
Garfo

Ref	€	Puntas	cm	L (cm)	U.Venta
60002	15,40	2	7x8	57,5	6
60003	17,10	3	7x13	57,5	6



Inox  
18/10



### Rasera alambre

Araignée à fil  
Fritierlöffel  
Mesh skimmer  
Escumadeira arame

Ref	€	Ø (cm)	L (cm)	U.Venta
67410	13,90	10	37,0	6
67412	18,90	12	44,0	6
67415	30,30	15	55,5	6
67417	35,30	17	56,0	6
67420	43,30	20	58,0	6



### Espumadera alambre

Ecumoire à friture  
Fritierlöffel  
Skimmer  
Escumadeira arame

Ref	€	Ø (cm)	L (cm)	U.Venta
60409	12,80	10	47,0	6
60411	13,90	12	49,0	6
60413	16,70	14	50,5	6
60415	18,40	16	52,0	6
60417	21,70	18	58,0	6
60419	25,90	20	59,0	6
60423	32,70	24	71,5	6
60427	38,30	28	74,0	6



### Espumadera alambre

Ecumoire etamee  
Fritierschaufel  
Tinned skimmer  
Escumadeira de arame

Ref	€	Ø (cm)	L (cm)	U.Venta
63514	11,90	14	54,0	1
63516	12,70	16	56,5	1
63518	13,10	18	56,5	1
63520	16,30	20	67,0	1
63524	18,00	24	70,5	1
63528	21,30	28	76,0	1

Alambre estañado · Tinned wire



Inox  
18/10

### Cazo servir 'POCHON'

Pochon  
Suppenkelle "Pochon" (Fur server)  
Pochon soup ladle for server  
Çaçarole servir "Pochon"

Ref	€	Ø (cm)	Mango (cm)	L (cm)	L	U.Venta
60520	59,70	20	22,50	42,5	2,00	1

Mango de madera  
Wooden handle



### Colador doble malla

Passoir maillee  
Passiersieb, stark  
Mesh strainer  
Coador rede dupla

	Ref	€	Ø (cm)	L (cm)	U.Venta
	61316	8,10	16	32,0	1
A	61318	9,40	18	34,0	1
	61320	11,00	20	37,0	1
	61323	28,00	23	56,0	1
B	61326	30,50	26	58,0	1
	61330	54,30	30	78,5	1
C	61335	65,50	35	84,0	1

2 Ganchos  
2 Hooks

1 Gancho  
1 Hook

Alambre estañado · Tinned wire

### Nidos de alambre

Panier à nid  
Nestbacklöffel  
Bird's nest mould  
Ninhos de arame



Ref	€	cm	L (cm)	U.Venta
62957	22,60	7-9	35	1
62959	26,40	9-11	37	1



### Cuchara apoya utensilios

Cuillère ramasse ustensiles  
Vorlegelöffel  
Spoon holder utensils  
Colher recolhe utensílios

Ref	€	cm	L (cm)	U.Venta
62972	11,50	25x12	25	1

# Colección **BUFFET**

Inox  
18/10



Dishwasher

## Cacillo

Louche  
Schöpfkelle  
Ladle  
Concha



Ref	€	Ø (cm)	ml	L (cm)	U.Venta
72853	11,30	6	70	24,5	6

## Cuchara lisa

Cuillère lisse  
Servierlöffel  
Spoon  
Colher lisa



Ref	€	cm	ml	L (cm)	U.Venta
72857	10,40	5x8	100	27,5	6

## Cuchara perforada

Cuillère perforée  
Servierlöffel, gelocht  
Perforated spoon  
Colher perfurada



Ref	€	cm	ml	L (cm)	U.Venta
72858	10,40	5x8	100	27,5	6

## Espumadera

Ecumoire  
Schaumlöffel  
Skimmer  
Escumadeira



Ref	€	Ø (cm)	L (cm)	U.Venta
72854	12,60	8	27,0	6

## Espátula perforada

Spatule perforée  
Pfannenschaufel, gelocht  
Perforated spatula  
Espátula perfurada



Ref	€	cm	L (cm)	U.Venta
72859	11,30	7x9	28,5	6

## Cacillo salsa

Louche sauce  
Saucengliesslöffle  
Gravy ladle  
Concha para molho



Ref	€	cm	ml	L (cm)	U.Venta
72850	11,30	5x7,5	35	23,5	6

## Pala ensalada

Pelle à salade  
Salatschaufel  
Salat scoop  
Espátula de salada



Ref	€	cm	L (cm)	U.Venta
72851	10,80	6x8,5	28,0	6

## Pala pastel perforada

Palette à gâteau perforée  
Kuchenschaufel, gelocht  
Perforated cake scoop  
Espátula de bolos



Ref	€	cm	L (cm)	U.Venta
72856	11,30	6,5x11	31,5	6

## Tenedor

Fourchette  
Tranchiergabel  
Fork  
Garfo



Ref	€	cm	L (cm)	U.Venta
72855	9,20	4,5x9	28,5	6

# Colección PROFESIONAL

Inox  
18/10



Dishwasher

## Cacillo

Louche  
Schöpfkelle  
Ladle  
Concha



Ref	€	Ø (cm)	ml	L (cm)	U.Venta
72803	20,70	10	150	37,0	6

## Cuchara lisa

Cuillère lisse  
Servierlöffel  
Spoon  
Colher lisa



Ref	€	cm	L (cm)	U.Venta
72807	15,40	7x11	36,0	6

## Cuchara perforada

Cuillère perforee  
Servierlöffel, gelocht  
Perforated spoon  
Colher perfurada



Ref	€	cm	L (cm)	U.Venta
72808	15,70	7x11	35,5	6

## Espátula lisa

Spatule lisse  
Backschaufel  
Spatula  
Espátula lisa



Ref	€	cm	L (cm)	U.Venta
72806	14,90	9x12	39,0	6

## Espátula perforada

Spatule perforee  
Pfannenschaufel, gelocht  
Perforated spatula  
Espátula perfurada



Ref	€	cm	L (cm)	U.Venta
72809	16,70	9x12	39,0	6

## Espumadera

Ecumoire  
Schaumlöffel  
Skimmer  
Escumadeira



Ref	€	Ø (cm)	L (cm)	U.Venta
72804	17,20	11	37,0	6

## Tenedor

Fourchette  
Tranchiergabel  
Fork  
Garfo



Ref	€	cm	L (cm)	U.Venta
72805	14,00	3x10	35,5	6

## Cacillo salsa

Louche sauce  
Saucengliesslöffle  
Gravy ladle  
Concha para molho



Ref	€	Ø (cm)	ml	L (cm)	U.Venta
72810	15,60	6,5	50	29,0	6

## Servidor espaguetis

Cuillère à spaguetis  
Spaghettiheber  
Spaguetti server  
Servidor de esparguete



Ref	€	cm	L (cm)	U.Venta
72811	16,10	6,5x9	34,0	6

# Colección SUPER MONOBLOCK

Inox  
18/10



Dishwasher

## Cacillo

Louche  
Schöpfkelle  
Ladle  
Concha



Ref	€	Ø (cm)	ml	L (cm)	U.Venta
62603	16,80	10	100	31,0	6

## Cacillo salsa

Louche sauce  
Saucengliesslöffle  
Gravy ladle  
Concha para molho



Ref	€	cm	ml	L (cm)	U.Venta
62609	14,70	7x9	30	31,0	1

## Cuchara lisa

Cuillère lisse  
Servierlöffel  
Spoon  
Colher lisa



Ref	€	cm	L (cm)	U.Venta
62607	12,60	7x10	32,0	6

## Cuchara perforada

Cuillère perforee  
Servierlöffel, gelocht  
Perforated spoon  
Colher perforada



Ref	€	cm	L (cm)	U.Venta
62608	11,80	7x10	32,0	1

## Espumadera

Ecumoire  
Schaumlöffel  
Skimmer  
Escumadeira



Ref	€	Ø (cm)	L (cm)	U.Venta
62604	16,80	11	36,5	6

## Espátula

Spatule lisse  
Backschaufel  
Spatula  
Espátula



Ref	€	cm	L (cm)	U.Venta
62606	12,30	8x9	33,5	6

## Tenedor

Fourchette  
Tranchiergabel  
Fork  
Garfo



Ref	€	cm	L (cm)	U.Venta
62605	10,70	3x8	33,5	1

## Servidor espaguetis

Cuillère à spaguettis  
Spaghettiheber  
Spaguetti server  
Servidor de esparguete



Ref	€	Ø (cm)	L (cm)	U.Venta
62811	14,00	7,5	31,0	6

Cacillo (62603)  
Espumadera (62604)  
Tenedor (62605)  
Espátula (62606)  
Cuchara lisa (62607)

## Jgo. de cocina 5 pzas. pie giratorio

5 Ustensiles de cuisine sur serviteur pivotant  
5 Tlg. Vorlegeteile auf Drehgestell  
5 piece kitchen tool set revolving rack  
Jogo de cozinha 5 peças pé giratório



Ref	€	h (cm)	U.Venta
62601	90,10		1
62630	23,90	40,0	1

Soporte · Hanging rack

# Colección MONOBLOCK



## Cacillo

Louche  
Schöpfkelle  
Ladle  
Concha



Ref	€	Ø (cm)	ml	L (cm)	U.Venta
62503	8,20	9	100	31,5	1

## Cuchara lisa

Cuillère lisse  
Servierlöffel  
Spoon  
Colher lisa



Ref	€	cm	L (cm)	U.Venta
62507	6,60	6,5x10	34,5	1

## Espumadera

Ecumoire  
Schaumlöffel  
Skimmer  
Escumadeira



Ref	€	Ø (cm)	L (cm)	U.Venta
62504	8,30	11,5	35,0	1

## Espátula

Spatule lisse  
Backschaufel  
Spatula  
Espátula



Ref	€	cm	L (cm)	U.Venta
62506	6,40	8x10	35,5	1

## Tenedor

Fourchette  
Tranchiergabel  
Fork  
Garfo



Ref	€	cm	L (cm)	U.Venta
62505	5,60	2,5x10	33,5	1



# Colección DUE

Inox  
18/10

PA  
Nylon

Si  
Silicone  
Colgador/ Hanger

Dishwasher

BPA free



## Cuchara lisa

Cuillère  
Servierlöffel  
Spoon  
Colher lisa

Ref	€	cm	L (cm)	U.Venta
68270	8,40	7x10,5	36,5	6



## Cacillo

Louche  
Schöpfkelle  
Ladle  
Concha

Ref	€	cm	ml	L (cm)	U.Venta
68271	8,60	10,5x9,5	100	33,5	6



## Espumadera

Ecumoire  
Schaumlöffel  
Skimmer  
Escumadeira

Ref	€	cm	L (cm)	U.Venta
68272	8,40	10,5x10,5	36,5	6



## Servidor espaguetis

Cuillère à spaguëtis  
Spaghettiheber  
Spaguetti server  
Servidor de esparguete

Ref	€	cm	L (cm)	U.Venta
68273	8,10	6,5x9,5	36,5	6



## Espátula

Spatule  
Schaufel  
Spatula  
Espátula

Ref	€	cm	L (cm)	U.Venta
68274	8,60	8,5x10,5	37,5	6



## Espátula perforada

Spatule perforée  
Schaufel, Gelocht  
Perforated spatula  
Espátula perforada

Ref	€	cm	L (cm)	U.Venta
68275	8,50	8,5x10,5	37,5	6



## Paleta de pescado

Pelle à poisson  
Fischheber  
Fish turner  
Espátula de peixe

Ref	€	cm	L (cm)	U.Venta
68276	8,60	8x14,5	36,5	6



# Colección **BLACK**



## Cacillo

Louche  
Schöpfkelle  
Ladle  
Concha



Ref	€	cm	ml	L (cm)	U.Venta
98903	3,80	8x9,5	125	31,0	12

## Espumadera

Ecumoire  
Schaumlöffel  
Skimmer  
Escumadeira



Ref	€	Ø (cm)	L (cm)	U.Venta
98904	3,80	11	33,0	12

## Cuchara salsa

Cuillère sauce  
Saucenservierlöffel  
Gravy spoon  
Colher para molho



Ref	€	cm	L (cm)	U.Venta
98905	3,80	7,5x9	25,0	12

## Espátula perforada

Spatule perforée  
Schaufel, Gelocht  
Perforated spatula  
Espátula perforada



Ref	€	cm	L (cm)	U.Venta
98906	3,80	9x10	31,0	12

## Cuchara lisa

Cuillère  
Servierlöffel  
Spoon  
Colher lisa



Ref	€	cm	L (cm)	U.Venta
98907	3,80	6,5x10	30,0	12

## Cuchara perforada

Cuillère perforée  
Servierlöffel, gelocht  
Perforated spoon  
Colher perforada



Ref	€	cm	L (cm)	U.Venta
98908	3,80	6,5x9	30,0	12

## Paleta de pescado

Pelle à poisson  
Fischheber  
Fish turner  
Espátula de peixe



Ref	€	cm	L (cm)	U.Venta
98909	3,80	8x16	32,0	12

## Cacillo salsa

Louche sauce  
Saucengliesslöffel  
Gravy andle  
Concha para molho



Ref	€	cm	ml	L (cm)	U.Venta
98910	3,80	6x8,5	30	27,0	12

## Servidor espaguetis

Cuillère à spaguettis  
Spaghettiheber  
Spaguetti server  
Servidor de esparguete



Ref	€	cm	L (cm)	U.Venta
98911	3,80	6x8	30,0	12

## Espátula corta

Spatule court  
Palette, Kurz  
Short spatula  
Espátula corta



Ref	€	cm	L (cm)	U.Venta
98912	3,80	8x12	28,0	12

## Espátula larga

Spatule longue  
Palette, Lang  
Long spatula  
Espátula comprida



Ref	€	cm	L (cm)	U.Venta
98913	3,80	4x7	31,0	12

## Batidor

Fouet  
Schneebeesen  
Whisk  
Batedor



Ref	€	cm	L (cm)	U.Venta
98914	3,80	7x7	30,0	12

# Colección **ECO**

**PA**

Nylon



Dishwasher



BPA free

## Cacillo

Louche  
Schöpfkelle  
Ladle  
Concha



Ref	€	Ø (cm)	ml	L (cm)	U.Venta
98803	5,10	9,5	110	29,0	12

- No rayan.
- Pensadas para rendir a la perfección con piezas antiadherentes.

· Ils ne rayent pas.  
· Conçus pour une efficacité optimum avec récipients antiadhésifs.

· Kein Verkratzen.  
· Ideal für Töpfe und Pfannen mit Antihafbeschichtung.

· They do not scratch.  
· Designed to perform perfectly with non-stick parts.

· Não riscam.  
· Pensados para tirar o máximo rendimento e perfeição com peças anti-aderentes.

## Cuchara lisa

Cuillère  
Servierlöffel  
Spoon  
Colher lisa



Ref	€	cm	L (cm)	U.Venta
98807	4,30	7,5x10	30,5	12

## Cuchara perforada

Cuillère perforee  
Servierlöffel, gelocht  
Perforated spoon  
Colher perfurada



Ref	€	cm	L (cm)	U.Venta
98808	4,00	7,5x10	30,5	12

## Espumadera

Ecumoire  
Schaumlöffel  
Skimmer  
Escumadeira



Ref	€	Ø (cm)	L (cm)	U.Venta
98804	4,80	11	31,5	12

## Espátula perforada

Spatule perforee  
Schaufel, gelocht  
Perforated spatula  
Espátula perfurada



Ref	€	cm	L (cm)	U.Venta
98806	4,40	8x10	33,0	12

## Cacillo salsa

Louche sauce  
Saucengliesslöffel  
Gravy ladle  
Concha para molho



Ref	€	cm	ml	L (cm)	U.Venta
98810	3,80	8x6,5	40	27,0	12

## Servidor espaguetis

Cuillère à spaguetis  
Spaghettiheber  
Spaguetti server  
Servidor de esparguete



Ref	€	Ø (cm)	L (cm)	U.Venta
98811	3,90	7,5	29,0	12



## Cacillo

Louche  
Schöpfkelle  
Ladle  
Concha

Ref	€	Ø (cm)	ml	L (cm)	U.Venta
64466	7,70	9,5	110	29,0	1



- Fabricados en silicona de alta calidad libre de BPA.
- Núcleo reforzado para una mayor resistencia sin perder flexibilidad en los bordes. Diseñados en una sola pieza, sin costuras ni grietas.
- Resistentes a altas temperaturas.
- Mango ergonómico suave al tacto y antideslizante.
- No rayan ni dañan artículos de cocina con antiadherente.
- Fácil de limpiar. Aptas para el lavavajillas.

- Fabriqué en silicone de haute qualité sans BPA.
- Noyau renforcé pour une résistance accrue sans perte de flexibilité des bords. Conception monobloc, sans coutures ni fissures.
- Résistant aux hautes températures.
- Poignée ergonomique, douce au toucher et antidérapante.
- Ne raye pas et n'endommage pas les ustensiles de cuisine antiadhésifs.
- Facile à nettoyer. Lavable au lave-vaisselle.

- Made of high quality BPA free silicone.
- Reinforced core improves strength without losing flexibility around the edges. Designed in a single piece without seams or cracks.
- Can withstand high temperatures.
- Soft and non-slip ergonomic handle.
- Does not scratch cooking utensils with non-stick coating.
- Easy to clean. Dishwasher safe.

## Cuchara lisa

Cuillere  
Servierlöffel  
Spoon  
Colher lisa

Ref	€	cm	L (cm)	U.Venta
64469	6,80	5,6x9,5	29,0	1



## Espumadera

Ecumoire  
Schaumlöffel  
Skimmer  
Escumadeira

Ref	€	Ø (cm)	L (cm)	U.Venta
64467	7,70	9	29,0	1



## Espátula perforada

Spatule perforée  
Schaufel, gelocht  
Perforated spatula  
Espátula perforada

Ref	€	cm	L (cm)	U.Venta
64468	6,80	7,5x9,5	29,0	1



## Servidor espaguetis

Cuillere à spaguetis  
Spaghettiheber  
Spaguetti server  
Servidor de esparguete

Ref	€	cm	L (cm)	U.Venta
64470	7,50	5,5x9,5	27,0	1



## Espátula estrecha

Spatule étroite  
Palette  
Narrow spatula  
Espátula estreita

Ref	€	cm	L (cm)	U.Venta
64471	6,80	4x12,5	27,0	1



## Pinza larga

Pince longue  
Znge,Lange  
Long tong  
Pinça comprida

Ref	€	L (cm)	U.Venta
64462	7,70	29,0	1



## Cuchara

Cuillere  
Servierlöffel  
Spoon  
Colher

Ref	€	L (cm)	U.Venta
64463	5,50	27,5	1



## Espátula

Spatule  
Schaufel  
Spatula  
Espátula

Ref	€	cm	L (cm)	U.Venta
64464	5,50	5,5x8	27,5	1



## Pincel

Pinceau  
Silikonpinsel  
Brush  
Pincel

Ref	€	L (cm)	U.Venta
64465	5,60	27,5	1



# Colección **NATURAL & BLACK**

new



- Fabricadas en fibra de madera, máxima calidad. Natural y ecofriendly.
- Robustas, resistentes y antibacterianas.
- Orificio para colgar.
- Fáciles de limpiar y aptas para el lavavajillas.

- Fabriqués en fibres de bois de la plus haute qualité. Naturel et ecofriendly.
- Robusts, résistants et antibactériens.
- Orifice pour suspendre.
- Facile à nettoyer et apte pour le lave-vaisselle.

- Hergestellt aus hochwertigsten Holzfasern. Natürlich und Ecofriendly.
- Robust, widerstandsfähig und antibakteriell.
- Einfach zu reinigen and Spülmaschinengeeignet.
- Praktische Öffnung zum Aufhängen.

- Made from wood fibre of the highest quality. Natural and ecofriendly.
- Robust, resistant and anti-bacterial.
- Hole for hanging.
- Easy to clean and dishwasher safe.



- Fabricadas em fibra de madeira da mais alta qualidade. Natural e ecofriendly.
- Robusto, resistente e antibactérias
- Orifício para pendurar.
- Fáciles de limpar e apta para a máquina de lavar louça.

## Utensilios NATURAL

Ustensiles  
Utensilien  
Utensils  
Utensílios

	Ref	€	L (cm)	U.Venta	
A	68165	7,20	29,5	1	Cuchara
B	68166	6,70	29,5	1	Espátula
C	68167	7,40	29,5	1	Cuchara perforada
D	68168	6,90	29,5	1	Espátula perforada
E	68169	7,00	29,5	1	Tenedor



## Utensilios BLACK

Ustensiles  
Utensilien  
Utensils  
Utensílios

	Ref	€	L (cm)	U.Venta	
A	68265	7,60	29,5	1	Cuchara
B	68266	7,00	29,5	1	Espátula
C	68267	7,70	29,5	1	Cuchara perforada
D	68268	7,20	29,5	1	Espátula perforada
E	68269	7,30	29,5	1	Tenedor



# Colección BRUN



## Cuchara lisa

Cuillère  
Servierlöfel  
Spoon  
Colher lisa

Ref	€	cm	L (cm)	U.Venta
68175	6,00	6x10	30,0	6

- Imprescindible en cualquier cocina por su resistencia a altas temperaturas y durabilidad.
- Conserva mejor los sabores de los alimentos al cocinarlos.
- Fabricadas en madera de haya natural de alta calidad, acabadas con aceites naturales.
- Mango que hace muy fácil el agarre y el manejo en la cocina.
- Apta para uso en sartenes con revestimiento antiadherente.

- Indispensable dans toute cuisine en raison de sa résistance aux hautes températures et sa durabilité.
- Conserve mieux les saveurs des aliments lors de leur cuisson.
- Fabriquées en hêtre naturel de grande qualité et dotées d'une finition aux huiles naturelles.
- Manche qui rend très facile la prise en main et la manipulation dans la cuisine.
- Apte pour un usage sur des poêles avec revêtement antiadhésif cuisine.



## Cuchara perforada

Cuillère perforée  
Servierlöfel, gelocht  
Perforated spoon  
Colher perfurada

Ref	€	cm	L (cm)	U.Venta
68176	6,30	7x10	30,0	6

- Sehr temperaturbeständig und langlebig und daher in jeder Küche unentbehrlich.
- Geschmack der Lebensmittel bleibt beim Kochen besser erhalten.
- Aus naturbelassenem Buchenholz von hoher Qualität und mit organischer Lasur.
- Handgriff, der das Greifen und die Handhabung in der Küche erleichtert.
- Zur Verwendung mit antihafbeschichteten Pfannen geeignet.

- Essential in any kitchen because of their resistance to high temperatures and their durability.
- Better preserve the flavours of cooked food.
- Made from natural beech wood of high quality and finished with natural oils.
- Handle making it very easy to pick up and manipulate when cooking.
- Suitable for use in frying pans with non-stick coating.



## Espátula lisa

Spatule  
Backschauffel  
Spatule  
Espátula lisa

Ref	€	cm	L (cm)	U.Venta
68177	6,00	6,5x10	30,0	6

- Imprescindível em qualquer cozinha pela sua durabilidade e resistência a altas temperaturas.
- Conservam melhor os sabores dos alimentos ao cozinhá-los.
- Fabricados em madeira de faia natural de alta qualidade e com acabamento de óleos naturais.
- Mango que facilita o agarre e o manejo na cozinha.
- Apta para uso em sertãs com revestimento antiaderente.



## Espátula perforada

Spatule perforée  
Backschauffel, gelocht  
Perforated spatule  
Espátula perfurada

Ref	€	cm	L (cm)	U.Venta
68178	6,20	7,5x12	30,0	6

## Cuchara ensalada

Cuillère à salade  
Salat Servierlöfel  
Salad spoon  
Colher de salada

Ref	€	cm	L (cm)	U.Venta
68173	7,00	8x7	30,0	6



## Cuchara especial

Cuillère spécial  
Salat-Servierlöfel  
Special spoon  
Colher especial

Ref	€	cm	L (cm)	U.Venta
68179	6,50	6,5x10	30,0	6

## Tenedor ensalada

Fourchette à salade  
Salat-Gabel  
Salad fork  
Garfo de salada

Ref	€	cm	L (cm)	U.Venta
68174	7,00	8x7	30,0	6



# Colección UNITE



- Amplia colección de utensilios de cocina de calidad premium.
- Cabezal fabricado en silicona de grado alimentario de máxima calidad (libre de BPA).
- Mango ergonómico y antideslizante fabricado en madera de haya natural.
- Diseñados para proteger las sartenes, cacerolas, ollas, etc. y evitar ralladuras.
- Resistentes a altas temperaturas.
- Se pueden lavar en el lavavajillas, pero se recomienda lavar a mano.
- Incluyen un práctico orificio para colgar.

- Élargissez votre collection d'ustensiles de cuisine de qualité premium.
- Tête fabriquée en silicone alimentaire de la plus grande qualité (sans BPA).
- Manche ergonomique et antidérapant fabriqué en hêtre naturel.
- Conçus pour protéger les poêles, les casseroles, les faitouts, etc. et éviter les rayures.
- Résistants aux hautes températures.
- Pas de lave vaisselle.
- Incluent un orifice pratique pour les suspendre.

- Große Küchengeräte-Kollektion in Premium-Qualität.
- Kopfteil aus lebensmittelechtem Silikon höchster Qualität (BPA-frei).
- Ergonomischer und rutschfester Stiel aus biologischem Buchenholz.
- Schützt Pfannen, Kochtöpfen, Kasserollen usw. und verhindert Kratzer.
- Sehr hitzebeständig.
- Spülmaschinengeeignet, Handreinigung wird empfohlen.
- Mit praktischem Loch zum Aufhängen.

- A large collection of premium quality kitchen utensils.
- Head made of top quality food grade silicone (BPA free).
- Ergonomic non-slip handle made of natural beech wood.
- They are designed to protect frying pans, casseroles, pots, etc. and prevent scratches.
- Can withstand high temperatures.
- Dishwasher safe, but hand washing is recommended.
- Includes practical hole for hanging.

- Ampla coleção de utensílios de cozinha de qualidade premium.
- Cabeça fabricada em silicone de grau alimentar, da máxima qualidade (livre de BPA).
- Cabo ergonómico e antideslizante, fabricado em madeira natural de faia.
- Para proteger sertãs, caçarolas, panelas, etc. e evitar riscos.
- Resistentes a altas temperaturas.
- Podem lavar-se na máquina de lavar louça, embora se recomende a lavagem à mão.
- Incluem um prático orifício para pendurar.

## Cacillo

Louche  
Schöpfkelle  
Ladle  
Concha



Ref	€	Ø (cm)	ml	L (cm)	U.Venta
68187	6,48	8,0	130	31,5	1

## Cuchara lisa

Cuillère  
Servierlöffel  
Spoon  
Colher lisa



Ref	€	cm	L (cm)	U.Venta
68185	5,80	6,7x10,5	32	1

## Espátula

Spatule  
Backschauffel  
Spatule  
Espátula



Ref	€	cm	L (cm)	U.Venta
68195	4,30	5,6x8,5	26,5	1

## Espátula perforada

Spatule perforée  
Backschauffel, gelocht  
Perforated spatule  
Espátula perforada



Ref	€	cm	L (cm)	U.Venta
68186	5,90	7,5x10,5	33,5	1

## Espumadera

Ecumoire  
Schaumlöffel  
Skimmer  
Escumadeira



Ref	€	Ø (cm)	L (cm)	U.Venta
68188	6,80	11,5	33,5	1

## Servidor espaguetis

Cuillère à spaguetis  
Spaghettiheber  
Spaguetti server  
Servidor de esparguete



Ref	€	L (cm)	U.Venta
68189	5,90	32,5	1

## Pincel

Pinceau  
Silikonpinsel  
Brush  
Pincel



Ref	€	cm	L (cm)	U.Venta
68196	4,10	5,5x0,5	24,5	1

## Pelador liso

Éplucheuse plate  
Normalen Schäler  
Peeler plain blade  
Descascador liso



Ref	€	L (cm)	U.Venta
68197	4,20	14,5	1

## Pelador dentado

Éplucheuse dentelé  
Gezackter Schäler  
Serrated peeler  
Descascador serrilhado



Ref	€	L (cm)	U.Venta
68198	4,20	14,5	1

## Inox PP

Cuchilla  
Blade  
Polypropylene

- **Cabezal fabricado en polipropileno (libre de BPA) y fibra de vidrio; material ultrarresistente y duradero.**
- **Cuchilla de acero inoxidable de máxima calidad.**

- Tête fabriquée en polypropylène (sans BPA) et fibre de verre ; matériau ultrarésistant et durable.
- Lame en acier inoxydable de la plus grande qualité.

- Kopfteil aus Polypropylen (BPA-frei), Glasfaser, äußerst widerstandsfähiges und haltbares Material.
- Messer aus rostfreiem Stahl in höchster Qualität

- Head made of polypropylene (BPA free) and fibreglass, which is ultra-durable and long lasting.
- Top quality stainless steel knife.

- Cabeça fabricada em polipropileno (livre de BPA) e fibra de vidro; material ultra-resistente e durável.
- Lâmina de aço inoxidável da máxima qualidade.



Batidor  
Whisk

Multifuncional · 2 en 1  
Multifunctional · 2 in 1



Espátula  
Spatula

- **Batidor de varilla con práctico raspador de silicona incorporado.**
- **2 en 1: bate y recoge toda la mezcla del bol de forma fácil y rápida.**
- **Varillas fabricadas en acero inoxidable.**
- **Espátula de silicona inyectada en una de las varillas (certificado LFGB y libre de BPA).**

- Blade mixer with practical built-in silicone scraper.
- 2 in 1: Beat and scrape out the entire mixture from the bowl quickly and easily.
- Blades made of stainless steel.
- Silicone spatula injected into one of the blades (LFGB certified and BPA free).

## Batidor varilla con espátula

Fouet avec grattoir  
Schneebeesen mit Schaber  
Whisk with spatula  
Batedeira de varas com espátula



Ref	€	L (cm)	U.Venta
68199	5,90	27,0	1



# Colección NORDIC

new



- Cabezal fabricado en nylon, resistente y duradero, libre de BPA.
- Mango ergonómico de madera de haya 100% natural.
- No rayan; pensadas para rendir a la perfección con piezas antiadherentes.
- Tête fabriquée en nylon, résistant et durable, sans BPA.
- Manche ergonomique en 100% hêtre naturel.
- Ne raye pas; conçu pour un rendement parfait avec des ustensiles antiadhésifs.
- Kopf aus Nylon, widerstandsfähig und langlebig, BPA-frei.
- Ergonomischer Griff aus 100 % natürlichem Buchenholz.
- Sie kratzen nicht; entwickelt, um perfekt mit Antihaft-Teilen zu funktionieren.
- Head made of nylon. Strong and long lasting. BPA free.
- Ergonomic natural beech wood handle.
- Does not scratch. Intended to perform perfectly with non-stick pieces.
- Cabeça em nylon, resistente e durável, livre de BPA.
- Cabo ergonómico em madeira de faia 100% natural.
- Não riscam; projetados para funcionar perfeitamente com peças antiaderentes.

## Cacillo

Louche  
Schöpfkelle  
Ladle  
Concha



Ref	€	Ø(cm)	ml	L (cm)	U.Venta
68280	4,80	9	130	32,0	1

## Cuchara lisa

Cuillère  
Servierlöffel  
Spoon  
Colher lisa



Ref	€	cm	L (cm)	U.Venta
68281	4,80	6,2	34,0	1

## Espátula perforada

Spatule perforée  
Backschauffel, gelocht  
Perforated spatule  
Espátula perforada



Ref	€	cm	L (cm)	U.Venta
68282	4,80	8,4	35,3	1

## Espumadera

Ecumoire  
Schaumlöffel  
Skimmer  
Escumadeira



Ref	€	cm	L (cm)	U.Venta
68283	4,80	11,2	34,3	1

## Servidor espaguetis

Cuillère à spaguëtis  
Spaghettiheber  
Spaguëtti server  
Servidor de espaguete



Ref	€	cm	L (cm)	U.Venta
68284	4,80	6,5	34,0	1

# Cacillo para salsa **PIZZA**

new

Inox



Dishwasher



## Cacillo salsa

Louche sauce  
Saucengliesslöffel  
Gravy ladle  
Concha para molho

Fondo plano para extender de manera uniforme las salsas sobre la base de la pizza

- **Cacillo para salsas fabricado en acero inoxidable de máxima calidad. Acabado en brillo.**
- **Ideal para salsa de tomate.**
- **80 g de capacidad, ofrece la porción ideal para pizzas estándar de 30cm.**
- Louche à fond plat pour sauces fabriquée en acier inoxydable de la plus grande qualité. Finition brillante
- Idéal pour la sauce tomate.
- D'une capacité de 80 g, elle offre la dose idéale pour des pizzas standards de 30 cm.
- Saucenlöffel aus Edelstahl bester Qualität. Hochglanzpoliert.
- Ideal für Tomatensauce.
- 80 g Schöpfmenge, genau richtig für normale Pizza mit 30 cm Durchmesser.
- This sauce ladle is made of top quality stainless steel. It has a shiny finish.
- It's perfect for tomato sauce.
- The 80 g capacity is the perfect portion for standard 30 cm pizzas.
- Caçarola pequena para molhos, fabricada em aço inoxidável da máxima qualidade, com acabamento brilhante.
- Ideal para molho de tomate.
- Com uma capacidade de 80 g, a porção ideal para pizzas standard de 30 cm.

Ref	€	Ø(cm)	L (cm)	g	U.Venta
60562	5,60	7	27,0	80	1

# Espátula · Cuchara **SONDA**

SI

Silicone

Inox

Sonde

300°C  
-50°C  
572°F  
-64°F



2 in 1

**Espátula. Funda de silicona extraíble**  
Spatula. Removable silicone sleeve

**Termómetro. Sonda de acero inoxidable**  
Thermometer. Stainless steel probe



2 in 1

**Cuchara. Funda de silicona extraíble**  
Spoon. Removable silicone sleeve

**Termómetro. Sonda de acero inoxidable**  
Thermometer. Stainless steel probe



## Espátula silicona con termómetro sonda

Spatule en silicone avec Thermometre sonde  
Teigschaber mit Thermometer/Sonde  
Silicone spatula with Thermometer probe  
Espátula silicone com Termómetro sonda

Ref	€	L (cm)	U.Venta
62500	16,00	25	1

## Cuchara silicona con termómetro sonda

Cuillère en silicone avec Thermometre sonde  
Löffel mit Thermometer/Sonde  
Silicone spoon with Thermometer probe  
Colher silicone com Termómetro sonda

Ref	€	L (cm)	U.Venta
62528	17,20	25	1

# Utensilios VARIOS

Sección cuadrada  
(2,5x2,5 mm)  
Square section



Inox  
18/10  
Dishwasher



## Pincho moruno (6) Inox

Brochette carne en inox. (6)  
Fleischspiesse (6), Rostfrei  
St. steel skewersquare wire (6)  
Espeto moruno Inóx (6)

Ref	€	L (cm)	U.Venta
* 62446	4,90	20,0	12
62435	5,60	30,5	12
62445	6,60	40,5	12



Inox

## Contenedor cubiertos

Panier à couverts  
Besteckköcher  
Cutlery holder  
Copos para talheres



Ref	€	Ø (cm)	h (cm)	L	U.Venta
62962	21,00	12	13,6	1,40	1
62963	24,40	12	18,7	2,00	1

\* Aptas para las freidoras de aire (ref: 69508-69511)  
Suitable for air fryers (ref: 69508-69511)

## 6 ganchos carnicero

6 crochets de boucher  
6-Tlg Metzgerhaken  
6 butchers hook  
6 ganchos de carnicero

Ref	€	Puntas	Ø (mm)	L (cm)	A (cm)	U.Venta
39043	11,70	1	5	12,5	3,7	4
39044	18,10	1	5	18,5	4,5	1
39047	11,80	2	5	12,5	3,7	4
39048	18,30	2	5	18,5	4,5	1

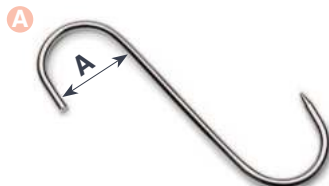

AL

Aluminium

## Barra sujeción notas

Barre à notes  
Zettelhalter  
Order rall  
Barra fixação notas

Ref	€	L (cm)	U.Venta
60731	11,70	30,50	1
60746	15,20	46,00	1
60761	18,20	61,00	1
60776	21,00	76,00	1
60791	26,10	91,50	1



## Colgador de barra

Penderie murale  
Hängeleiste  
Wall hanger  
Suporte de barra

Ref	€	Unidades	L (cm)	U.Venta
60740	22,50	6	40	1
60760	31,00	8	60	1
60710	42,90	12	100	1

## Juego de 6 ganchos

Ensemble 6 crochets  
Aufhänggehaken, 6er.-Set  
6 hook set  
Jogo de 6 ganchos

Ref	€	U.Venta
60700	6,70	12



# Preparación

Food processing

# Espátulas INOX



- Gran flexibilidad, ideal para voltear los alimentos.
- Su borde biselado ayuda a deslizarse debajo de los alimentos.
- Las ranuras de la espátula permiten que la grasa se escurra.

- Grande flexibilité, idéale pour retourner les aliments.
- Son bord biseauté aide à se glisser sous les aliments.
- Les rainures de la spatule permettent à la graisse de s'écouler.

- Kelle mit extra viel Flexibilität, Eignet sich ideal zum schonenden Wenden.
- Die abgeschrägte Kante gleitet problemlos unter das Kochgut.
- Mit fettabführenden Lamellen.

- Highly flexible, perfect for turning over food.
- Its bevelled edge helps it slide under food.
- The grooves on the spatula let fat flow away.

- Grane flexibilidade, ideal para voltear os alimentos.
- O seu rebordo biselado permite-lhe deslizar mais facilmente debaixo dos alimentos.
- As ranhuras da espátula permitem que a gordura esorra dos alimentos.



Inox  
18/10

SI  
Silicone



## Espátula de pescado PRO

Spatule à poisson  
Fischheber  
Fish spatula  
Espátula de peixe

Ref	€	L total (cm)	Paleta (cm)	U.Venta
60726	13,60	30	18x8	1



## Espátula flexible pescado

Spatule flexible à poisson  
Fisch Schaufel, flexible  
Flexible spatula to fish  
Espátula flexível para peixe

Ref	€	L (cm)	U.Venta
60426	4,40	30	6



## Espátula grill acodada

Spatule coudeée our grill  
Winkelpalette  
Bent grillspatula  
Espátula comprida grelha

Ref	€	cm	U.Venta
60434	5,90	12x27	6



## Espátula serrada

Spatule à gâteau  
Backschaufel  
Serrated spatula  
Espátula com serrilha

Ref	€	cm	U.Venta
62677	8,80	30x5,5	6



2 in 1  
Cortar · Cut    Servir · Serve up



## Paleta triangular mango solido

Grattoir manche noir m/solide  
Bratenspachtel, mit solidem Stiel  
Straight Scraper/turner  
Espátula triangular cabo sólido

Ref	€	cm	U.Venta
60430	6,80	10x11,5	12

### Espátula plancha mango solido

Spatule m/solide  
Grillspachtel, mit solidem Stiel  
Straight spatula  
Espátula grelha cabo sólido

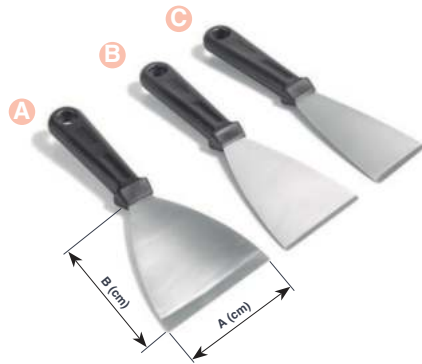

	Ref	€	A (cm)	B (cm)	U.Venta
A	60422	4,60	10	11,5	12
B	60445	3,90	8	11,5	12
C	60446	3,80	6	11,5	12

### Espátula lisa mango solido

Spatule lisse m/solide  
Spachtel, mit solidem Stiel  
Straight spatula  
Espátula lisa cabo sólido

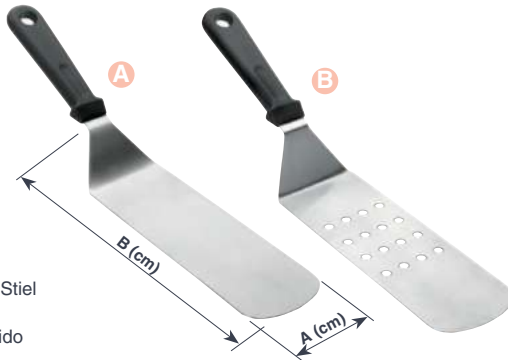

	Ref	€	AxB (cm)	U.Venta
A	60420	5,30	7,5x21,5	12
B	60421	5,20	7,5x21,5	12

### Espátula mango negro

Spatule manche noir  
Schaufel mit schwarzem Stiel  
Solid turner w/black H.  
Espátula cabo negro

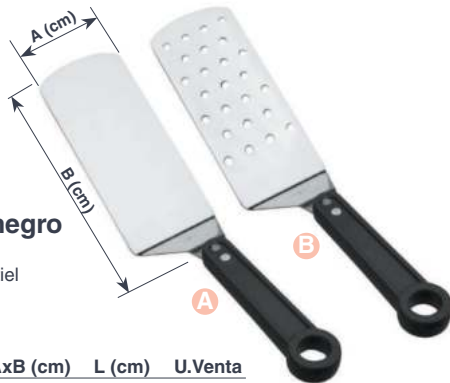

	Ref	€	AxB (cm)	L (cm)	U.Venta
A	60435	7,60	7,5x17	35	6
B	60438	7,70	7,5x17	35	6



### Espátula larga recta mango solido

Spatule longue droite m/solide  
Palette, lang, gerade  
Long straight spatula  
Espátula comprida c/cabo sólido

	Ref	€	L (cm)	U.Venta
	60461	3,70	15	12
	60462	3,80	20	12
	60463	3,90	25	12
	60464	4,00	30	12
	60465	4,10	35	12

### Espátula lisa mango solido

Spatule lisse m/solide  
Backschaufel, f. Festsoffe  
Straight spatula  
Espátula lisa cabo sólido

Ref	€	cm	U.Venta
60425	4,80	7x13,5	12



### Espátula repostería

Patisserie spatule  
Gebackpalette  
Pastry spatula  
Espátula pasteleria

Ref	€	cm	U.Venta
60443	4,00	6,5x14,5	12



### Espátula mini acodada

Mini spatule coudée  
Winkpalette Mini  
Mini bent spatula  
Espátula mini comprida

Ref	€	cm	U.Venta
60442	3,70	2x9	12



### Espátula acodada

Spatule coudée  
Winkpalette  
Bent spatula  
Espátula comprida

	Ref	€	L (cm)	U.Venta
A	60482	3,90	15	12
B	60483	4,20	19	12
C	60484	4,50	24	12



### Espátula larga acodada mango solido

Spatule longue coudée m/solide  
Winkpalette, lang  
Long bent spatula  
Espátula comprida c/cabo sólido

Ref	€	L (cm)	U.Venta
60467	3,90	20	12
60468	4,00	25	12
60469	4,10	30	12

**Inox**  
**18/10**

### Espátula gigante inox

Spatule geante en Inox  
Rührspatel, Edelstahl  
St steel long handle Turner  
Espátula gigante Inóx



Ref.	€	L (cm)	U.Venta
61481	66,60	80	1
61421	72,80	120	1



### Pala profesional polietileno

Pelle professionnelle polyéthylène  
Professionelle Ruhrspatel, Polyethylen  
Polyethylene professional shovel  
Pá professional polietileno

Ref.	€	L (cm)	U.Venta
60404	77,20	81,5	1

### Pala pizza mango desmontable

Pelle pizza manche démontable  
Pizzeriaofen-Schaufel, viereckig  
Square pizza oven scoop  
Pá de pizza cabo desmontável

Ref.	€	L (cm)	U.Venta
61460	102,90	160	1

**Inox**  
**18/10**

### Espátula pizza

Spatule pizza  
Pizzaspatel  
Pizza spatula  
Espátula pizza



Ref	€	cm	U.Venta
60424	13,80	16,5x17,5x5	12

**ABS**

Plastic

### Pala pizza

Pelle pizza  
Pizzaschaufel, flach  
Pizza flat scoop  
Espátula pizza



Ref	€	cm	U.Venta
61461	14,00	25x36	1

### Cortapizza

Roulette pizza  
Pizzaschneider  
Pizza cutter  
Corta-Pizza



**Inox**  
**18/10**

	Ref	€	Ø (cm)	U.Venta
<b>A</b>	60429	5,00	10	12
<b>B</b>	67004	17,50	10	1
<b>C</b>	67028	12,10	10	1
<b>D</b>	67027	5,80	8	6

# Colección RASQUETAS



Inox	PP	Si	Fibra de vidrio
	Polypropylene	Silicone	Fibre glass

new

- Cortador de masa fabricado en acero inoxidable de máxima calidad con escalas de medición en cm e in. Dispone de un mango antideslizante y ergonómico. Diseñado para cortar, dividir y formar masas, así como recoger harinas, etc.
- Espátula de silicona flexible de gran calidad. Ideal para el empleo en superficies poco uniformes, como boles esféricos.
- Raspador fabricado en polipropileno + fibra de vidrio de grado alimenticio y diseñado principalmente para decorar tartas y pasteles de forma práctica y sencilla.
- Duraderos y resistentes. Se limpian fácilmente. Aptos para el lavavajillas. Libres de BPA.

- Dough cutter made of top quality stainless steel with measurements marked in cm and inches. It has a non-slip ergonomic handle. It's designed to cut, divide and shape dough or pick up flour, etc.
- High quality flexible food safe silicone spatula, perfect for using on uneven surfaces like spherical bowls.
- Scraper made of food grade Polypropylene + Glass fiber mainly designed for decorating cakes and pies in a simple and easy way.
- Strong and long lasting, easy to clean and dishwasher safe. BPA free.



## Rasqueta

Coupe pate  
Schaber  
Scraper  
Raspador

Ref	€	cm	U.Venta
67041	25,10	13,8x13	1

Diseño apilable  
Stackable design

- Amasan, cortan y limpian.
- Indispensables a la hora de trabajar con masas.
- Nos ayudan a mover y cortar el amasado gracias a su filo.
- Gran ayuda a la hora de limpiar la superficie de trabajo eliminando los restos.

- They knead, cut and cleaning.
- Indispensables when working with mass.
- We help both move in the kneading and cutting edge thanks to its.
- Great help when cleaning the working surface by removing debris.



## Rasqueta

Coupe pate  
Schaber  
Scraper  
Raspador

Escala de medición  
Measurement scale

Ref	€	cm	U.Venta
67029	9,40	16,5x10,5	6

SI 230°C  
Silicone max



## Rasqueta silicona

Coupe pate en Silicone  
Schaber, Silikon  
Silicone scraper  
Raspador silicone

Ref	€	cm	U.Venta
67414	8,90	9x15	1

Inox  
18/10

## Rasqueta

Coupe pate  
Schaber  
Scraper  
Raspador



Ref	€	cm	U.Venta
A 67005	12,80	15x9	6
B 67006	12,40	15x9	6



# Espátulas SILICONA



## Espátula silicona

Spatule en silicone  
Teigschaber  
Silicone spatula  
Espátula de silicone

Ref	€	L (cm)	U.Venta
A 64450	5,60	25	6
A 64451	8,90	35	6
B 64460	5,80	25	6
B 64461	9,70	35	6



## Espátula silicona GREY

Spatule en silicone  
Teigschaber  
Silicone spatula  
Espátula de silicone

Ref	€	L (cm)	U.Venta
67434	4,70	30	12
67435	5,40	29	12



## Espátula UNITE

Spatule  
Backschauffel  
Spatule  
Espátula

Ref	€	cm	L (cm)	U.Venta
68195	4,30	5,6x8,5	26,5	1



## Espátula silicona WHITE

Spatule en silicone  
Teigschaber  
Silicone spatula  
Espátula de silicone

Ref	€	L (cm)	U.Venta
67421	4,60	20	1
67427	6,80	26	1
67433	14,90	32	1

## Espátula silicona

Spatule en silicone  
Teigschaber  
Silicone spatula  
Espátula de silicone

Ref	€	L (cm)	U.Venta
A 64444	5,90	28	1
B 64445	6,60	30	1
C 64446	6,70	31	1



## Set repostería (20 pcs.)

Exposant pâtisserie  
Aufsteller Pastry  
Pastry display  
Expositor pasteleria

Ref	€	L (cm)	Pieza	U.Venta
A 64424	78,30	-	Caja (20 pcs.) / Set (20 pcs.)	1
B 64426	4,00	23,0	Pincel / Brush	12
C 64427	4,00	23,0	Espátula / Spatula	12
D 64428	4,00	23,0	Lengua gato / Spatula	12
E 64429	4,00	23,0	Batidor / Whisk	12

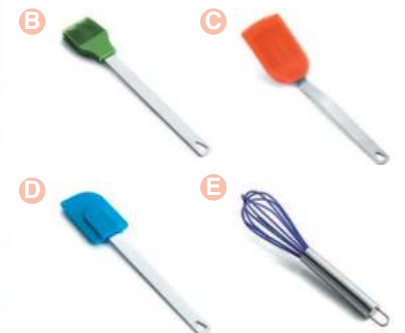

# Colección GREY & OCEAN



- Fabricados en silicona de alta calidad libre de BPA.
- Núcleo reforzado para una mayor resistencia sin perder flexibilidad en los bordes. Diseñados en una sola pieza, sin costuras ni grietas.
- Resistentes a altas temperaturas.
- Mango ergonómico suave al tacto y antideslizante.
- No rayan ni dañan artículos de cocina con antiadherente.
- Fáciles de limpiar. Aptas para el lavavajillas.

- Fabriqués en silicone de haute qualité sans BPA.
- Noyau renforcé pour une résistance accrue sans perte de flexibilité des bords. Conception monobloc, sans coutures ni fissures.
- Résistant aux hautes températures.
- Poignée ergonomique, douce au toucher et antidérapante.
- Ne raye pas et n'endommage pas les ustensils de cuisine antiadhésifs.
- Facile à nettoyer. Lavable au lave-vaisselle.

- Aus hochwertigem Silikon, BPA-frei.
- Verstärkter Kern für mehr Widerstand, flexible Schale. Sehr hitzebeständig.
- Ergonomischer Griff, angenehmes Handgefühl, rutschfest.
- Aus einem Stück gefertigt, ohne Nähte, ohne Spalten.
- Verkratzt oder beschädigt nie wieder die Antihafbeschichtung von Pfannen oder Töpfen.
- Leichte Reinigung. Spülmaschinengeeignet.

- Made of high quality BPA free silicone.
- Reinforced core improves strength without losing flexibility around the edges. Designed in a single piece without seams or cracks.
- Can withstand high temperatures.
- Soft and non-slip ergonomic handle.
- Does not scratch cooking utensils with non-stick coating.
- Easy to clean. Dishwasher safe.

- Fabricado em silicone de alta qualidade, sem BPA.
- Núcleo reforçado para uma maior resistência, sem perda de flexibilidade nas bordas. Design de uma única peça, sem costuras nem gretas.
- Resistente a altas temperaturas.
- Cabo ergonómico, suave ao tato e antideslizante.
- Não risca nem danifica os artigos de cozinha com revestimento antiaderente.
- Fácil de limpar. Apto para máquinas de lavar louça.



## Utensilios GREY

Ustensiles en silicone  
Silikonutensilien  
Silicone utensils  
Utensílios de silicone

	Ref	€	L (cm)	U.Venta	
	64459	15,60	27,5	1	<b>Set 3 utensilios</b> · Set 3 utensils
A	64463	5,50	27,5	1	<b>Cuchara</b> · Spoon
B	64464	5,50	27,5	1	<b>Espátula</b> · Spatula
C	64465	5,60	27,5	1	<b>Pincel</b> · Brush



## Utensilios OCEAN

Ustensiles en silicone  
Silikonutensilien  
Silicone utensils  
Utensílios de silicone

	Ref	€	L (cm)	U.Venta	
	64452	16,70	27,5	1	<b>Set 3 utensilios</b> · Set 3 utensils
A	64453	5,80	27,5	1	<b>Cuchara</b> · Spoon
B	64454	5,80	27,5	1	<b>Espátula</b> · Spatula
C	64455	5,80	27,5	1	<b>Pincel</b> · Brush

# Colección BATIDORES

Inox  
18/10



Dishwasher



Inox

## Batidor MINI

Mini fouet Inox  
Mini-Schneebeesen  
Mini whisk  
Mini batedor Inóx

Ref	€	L (cm)	U.Venta
61615	5,40	15	12
61620	6,00	20	12



## Batidor EXTRA 8

Fouet inox extra 8  
Schneebeesen, Extra 8  
Extra 8 whisk  
Batedor Extra 8

Ref	€	L (cm)	U.Venta
61625	8,50	25	6
61630	8,70	30	6
61635	9,10	35	6
61640	10,00	40	6
61645	10,80	45	6
61650	12,10	50	6
61655	12,80	55	6
61660	13,80	60	6



- Batidor de varilla con práctico raspador de silicona incorporado.
- 2 en 1: bate y recoge toda la mezcla del bol de forma fácil y rápida.
- Varillas fabricadas en acero inoxidable (Ø 2 mm).
- Espátula de silicona inyectada en una de las varillas (certificado LFGB y libre de BPA).

- Blade mixer with practical built-in silicone scraper.
- 2 in 1: Beat and scrape out the entire mixture from the bowl quickly and easily.
- Blades made of stainless steel (Ø 2 mm).
- Silicone spatula injected into one of the blades (LFGB certified and BPA free).

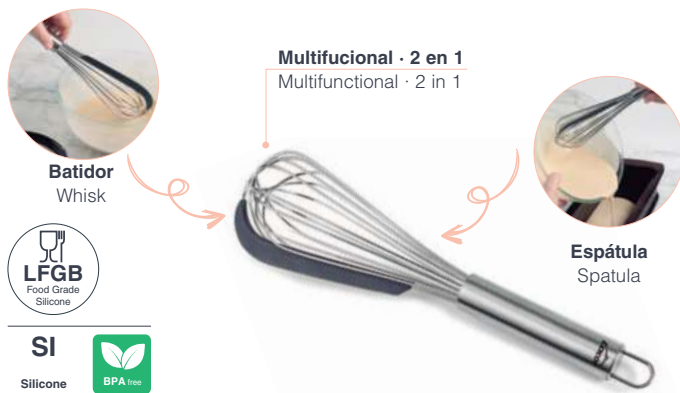

## Batidor SUPER 12

Fouet inox super 12  
Schneebeesen, super 12  
Super 12 whisk  
Batedor Super 12

Ref	€	L (cm)	U.Venta
61626	7,80	25	6
61631	8,40	30	6
61636	9,10	35	6
61641	9,60	40	6
61646	9,90	45	6
61651	10,80	50	6



SI 250°C  
Silicone max BPA free

## Batidor varilla silicona

Fouet en silicone  
Rührbesen auf Silikon  
Silicone wire whisk  
Batedor vareta silicone

Ref	€	L (cm)	U.Venta
61621	8,00	20	12
61622	8,90	25	6
61623	9,90	30	12

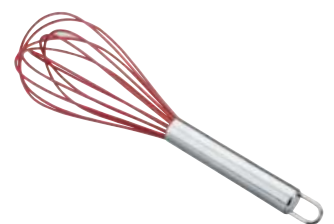

## Batidor de varillas con raspador de silicona

Fouet avec grattoir en silicone  
Schneebeesen mit Silikonschaber  
Whisk with built-in silicone  
Batedeira de varas com raspador de silicone

Ref	€	L (cm)	U.Venta
61627	6,20	32	12



**Batidor**  
Whisk

**Multifuncional · 2 en 1**  
Multifunctional · 2 in 1



**Espátula**  
Spatula



- Batidor de varilla con práctico raspador de silicona incorporado.
- 2 en 1: bate y recoge toda la mezcla del bol de forma fácil y rápida.
- Varillas fabricadas en acero inoxidable.
- Espátula de silicona inyectada en una de las varillas (certificado LFGB y libre de BPA).

- Blade mixer with practical built-in silicone scraper.
- 2 in 1: Beat and scrape out the entire mixture from the bowl quickly and easily.
- Blades made of stainless steel.
- Silicone spatula injected into one of the blades (LFGB certified and BPA free).

### Batidor varilla con espátula

Fouet avec grattoir  
Schneebeesen mit Schaber  
Whisk with spatula  
Batedeira de varas com espátula

Ref	€	L (cm)	U.Venta
68199	5,90	27,0	1

### Batidor FIBREGLASS

Fouet  
Schneebeesen  
Whisk  
Batedores

Ref	€	L (cm)	U.Venta
61624	11,80	25	6
61629	13,60	30	6
61634	15,40	35	6
61639	17,00	40	6
61644	20,40	45	6
61649	21,40	50	6



**Ergonómico**  
Ergonomic



### Batidor silicona FIBREGLASS

Fouet en silicone  
Schneebeesen, Silikon  
Silicone whisk  
Batedores silicona

Ref	€	L (cm)	U.Venta
61524	10,80	25	6
61529	11,70	30	6
61534	13,60	35	6



**Ergonómico**  
Ergonomic

### Batidor gigante

Fouet à purée  
Kesselbesen  
Big whisk  
Batedor gigante

Ref.	€	cm	Ø Varilla (mm)	U.Venta
60610	62,40	100	3	12
60612	80,00	129	3	12



**Varilla · Rod: Ø3 mm**

Inox

### Batidor manivela

Batteur-mélangeur à manivelle  
Schneequirl  
Egg beater  
Batedor de manivela

Ref	€	U.Venta
62901	19,10	6



### Batidor capuccino

Batteur pour cappuccino  
Capuccino- Mixer  
Capuccino mixer  
Batedor capuccino

Ref	€	W	U.Venta
69041	26,70	2,7	1



# Colección PINCELES



## Pincel virola Inox mango polipropileno

Pinceau patisier V. Inox M. polipropylene  
Fett-/Kuchenpinsel, mit Stiel aus Polypropylen, schaft Edelstahl  
Flat pastry brush s.steel polypropylene handle  
Pincel aro Inóx cabo polietileno

Ref	€	L (cm)	Cerdas (cm)	U.Venta
64430	4,30	23,0	4,4x3,0	1
64435	5,00	24,0	4,4x3,5	1
64440	5,20	24,5	4,4x4,0	1
65044	6,40	25,0	5,0x4,5	1
65050	7,70	26,0	5,0x5,0	1

- Para cocina o repostería.
- Prácticas espátulas o lenguas de gato para rebañar boles, cazuelas, fuentes, etc.
- Pinceles ideales para pincelar con aceites o salsas, marinar carnes o pescados, engrasar moldes, untar con aceite, huevo batido, almíbar, etc.
- No absorben olores ni sabores.

- Pour la cuisine ou la pâtisserie.
- Pratiques spatules ou langues de chats pour récupérer les éléments restant dans les bols, casseroles, etc.
- Pinceaux parfaits pour badigeonner de l'huile ou des sauces, mariner des vandes ou des poissons, graisser des moules, étaler de l'huile, de l'œuf battu, du sirop, etc.
- N'absorbent ni les odeurs ni les goûts.

- Zum Kochen oder Backen.
- Praktische Spachtel oder Schaber zum auskratzen von Schalen, Kasserollen, Schüsseln, etc.
- Pinsel ideal zum Einstreichen mit Öl, Sauce, Marinieren von Fleisch oder Fisch
- Einfetten von Backformen, zum Einölen, zum Bestreichen mit Ei oder Sirup usw.
- Nehmen weder Geschmack noch Geruch an.

- For cooking or baking.
- Practical spatulas for scraping bowls, pots, dishes, etc.
- Brushes ideal for brushing oils or sauces, marinating meat or fish, greasing baking tins, and basting with oil, egg, syrup, etc.
- Doesn't absorb smells or tastes.

- Para cozinha ou pastelaria.
- Prácticas espátulas ou linguas de gato para barrar boles, caçarolas, formas e travessas, etc.
- Pinceles ideais para pincelar com óleos ou molhos, marinar carnes ou peixes, untar formas, untar com óleo, ovo batido, caldas, etc.
- Não absorvem odores nem sabores.

Dimensiones reales - Real dimensions

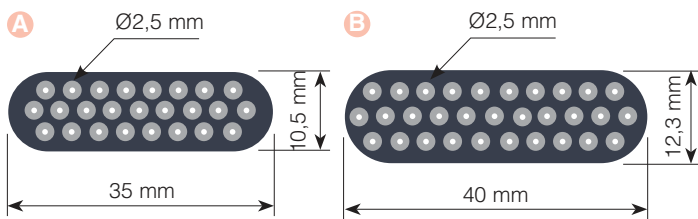

## Pincel de silicona mango inox

Pinceau de cuisine embout en silicone  
Silikonpinsel, langer stiel  
Silicone brush st.steel long handle  
Pincel de silicone cabo inóx

Ref	€	L (cm)	U.Venta
A 64425	6,80	24	12
B 64431	7,20	24	12



## Pincel de silicona

Pinceau en silicone  
Silikonpinsel,  
Silicon brush  
Pincel de silicone

Ref	€	L (cm)	U.Venta
64441	6,70	23	1



**HAYA**  
Beech  
Wood

## Pincel UNITE

Pinceau  
Silikonpinsel  
Brush  
Pincel

Ref	€	cm	L (cm)	U.Venta
68196	4,10	5,5x0,5	24,5	1



**Inox**  
18/10

## Pincel de silicona

Pinceau en silicone  
Silikonpinsel  
Silicon brush  
Pincel silicone

Ref	€	L (cm)	U.Venta
A 64418	10,80	22	1
B 64422	12,10	23	1



# Pala para PATATAS

new

Inox ABS  
Plastic Dishwasher



- Palas profesionales fabricadas en acero inoxidable de gran calidad.
- Diseño trapezoidal para recoger y embolsar patatas fritas en fracciones individuales de forma rápida.
- Multifuncional: también se puede usar para servir palomitas de maíz, nueces, hielo o dulces.
- 1 o 2 mangos ergonómicos y antideslizantes para usuarios zurdos y diestros.
- Fácil de limpiar. Apts para el lavavajillas.

- Pelle professionnelle fabriquée en acier inoxydable de grande qualité.
- Forme trapézoïdale pour attraper et mettre rapidement en cornet des frites en portions individuelles.
- Multifonctions : peut également être utilisée pour servir du pop-corn, des noix, des glaçons ou des bonbons.
- 1 ou 2 manches ergonomiques et antidérapants pour des utilisateurs aussi bien gauchers que droitiers.
- Facile à nettoyer. Compatible avec le lave-vaisselle.

- These professional French fry scoops are made of high quality stainless steel.
- They have a trapezoidal design for scooping and bagging individual portions of French fries quickly.
- Multi-function: they can also be used to serve popcorn, nuts, ices or sweets.
- They have one or two ergonomic non-slip handles for right and left-handed users.
- Easy to clean and dishwasher safe.

## Pala para patatas

Pelle à pommes de terre  
Kartoffelschaufel  
Potato shovel  
Pá de batatas

	Ref	€	cm	e (mm)	NºAsas	U.Venta
A	62678	12,60	20x22	0,7	1	1
B	62679	14,80	20x22	0,7	2	1

# Colección HUEVO

Inox 18/10  
Dishwasher



Asegura una separación limpia  
Ensures clean separation

## Separador de claras

Séparateur à oeuf  
Eier-Separator  
Eggs separator  
Separador de ovos

Ref	€	U.Venta
61608	7,80	6



## Soporte huevo OVUM

Support d'oeufs  
Eierbecher  
Egg stand  
Suporte de ovo

Ref	€	Ø (cm)	h (cm)	U.Venta
68285	2,90	4,5	5	6



SI  
Silicone BPA free

## Molde huevo

Moule à oeufs  
Eierform  
Egg mould  
Molde ovo

	Ref	€	cm	U.Venta
A	68080	6,10	Ø10x2	1
B	68082	6,10	10,5x10,5x2	1

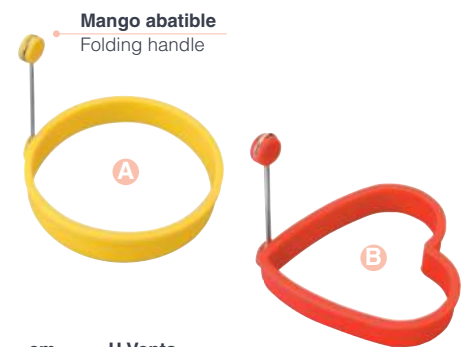

Inox

## Molde huevo-sándwich

Moule à oeufs-sandwich  
Eier-/Sandwichring  
Mould for egg-sandwich  
Molde ovo-Sandwich

	Ref	€	cm	U.Venta
A	68005	3,20	Ø8,5	12
B	68006	3,20	8,5x8,5	12



# Jarras MEDIDORAS

Inox  
18/10



Dishwasher



**Vertedor antigoteo**  
Non-drip spout

**Marcajes de capacidad**  
Capacity markings

## Jarra 5 litros

Pot en inox 5 L  
Kanne 5 L  
5 L. pitcher  
Jarra 5 L

Ref.	€	Ø (cm)	L	U.Venta
62750	75,80	17x22,5	5,00	1

## Jarra de medidas cónica

Pot mesureur  
Messbecher  
Measuring cup  
Jarra de medidas cónica



Ref	€	L	U.Venta
67010	36,00	1,00	1

**Marcajes de capacidad en el interior en onzas, ml, L y ccm (centímetro cúbico)**  
Capacity markings inside in ounces, mL, L and ccm (cubic centimetres)

**Vertedor antigoteo**  
Non-drip spout

**Jarra medidora** Pot  
mesureur  
Mass  
Behälter  
Measuring jug  
Jarra de medidas

	Ref	€	Ø (cm)	h (cm)	L	U.Venta
A	62745	14,40	9,0	10,5	0,5	1
B	62741	21,80	11,5	13,0	1,0	1
C	62742	25,80	15,0	17,0	2,0	1



**Sist. de lectura rápida en mililitros y cups**  
Easily readable markings in millilitres and cups

- Jarra fabricada en vidrio borosilicato.
- Sistema de lectura rápida en mililitros y cups.
- Vertedor antigoteo.
- Resistente a choques térmicos.
- Fácil limpieza: apto para el lavavajillas.



- Pichet fabriqué en verre borosilicaté.
- Système de lecture rapide en millilitres et en tasses.
- Bec verseur anti-gouttes.
- Résistant aux chocs thermiques.
- Nettoyage facile : apte pour le lave-vaisselle.

- Jug made of borosilicate glass.
- Easily readable markings in millilitres and cups.
- Non-drip spout.
- Highly resistant to thermal shock
- Easy to clean: dishwasher safe.

**100% higiénica**  
100% hygienic

Vidrio



Glass Microwave

## Jarra medidora

Pot mesureur  
Mass Behälter  
Measuring jug  
Jarra de medidas

Ref	€	L	U.Venta
67133	11,00	0,5	1

**Sistema de lectura rápida en ml, L y ccm (centímetro cúbico)**  
Easily readable markings in ml, l and ccm (cubic centimeter)

**Vertedor antigoteo**  
Non-drip spout

PP



Polypropylene

BPA Free

## Jarras medidoras

Pot mesureur  
Mass Behälter  
Measuring jugs  
Jarras de medidas

	Ref	€	Ø (cm)	h (cm)	L	U.Venta
A	67210	3,50	9,0	13,8	0,5	1
B	67211	4,60	12,0	17,0	1,0	1
C	67212	7,90	15,0	20,8	2,0	1
D	67213	10,30	17,0	23,5	3,0	1
E	67214	16,00	20,0	27,5	5,0	1





### Set 5 jarras medidoras

Setn5 pichets doseurs  
Messbecher, 5 Er-Set  
Set of 5 measuring jugs  
Conjunto 5 jarras medidas

Ref	€	cm	h (cm)	L	U.Venta
67215	39,90	15x9	15,3	0,5	1
		18x11	18,8	1,0	
		22x15	23,0	2,0	
		24x17	26,0	3,0	
		27x20	30,2	5,0	

**Vertedor antigoteo**  
Non-drip spout

**Jarras apilables**  
Stackable jugs

**Sistema de lectura rápida en mililitros (ml) , litros (L) y ccm (centímetro cúbico)**

Easily readable markings in milliliters (ml), Liters (l) and ccm (cubic centimeter)



**Sist. de lectura rápida en mililitros y cups**  
Easily readable markings in millilitres and cups



### Jarra medidora

Pot mesureur  
Mass Behälter  
Measuring jug  
Jarra de medidas

Ref	€	L	U.Venta
67136	5,10	0,5	1



### Jarra medidora SPIN

Pot mesureue  
Mass Behälter  
Measuring jug  
Jarra de medidas

Ref	€	L	U.Venta
67165	11,80	0,5	1



**Sist. de lectura rápida en mililitros y cups**  
Easily readable markings in millilitres and cups

**Marcajes de capacidad en ml, dl, onzas y cup**  
Capacity markings in ml, dl, ounces and cups



### Vaso medidor BASIC

Verre doseur  
Messbecher  
Measuring cup  
Copo medidor

	Ref	€	Ø (cm)	h (cm)	L	U.Venta
A	67075	7,40	8,5	16,0	0,5	1
B	67071	9,60	10,5	19,0	1,0	1

**Incluye borde para facilitar el vertido**  
Includes rim for easy pouring



**Sist. de lectura rápida en litros, mililitros, onzas y cups**

Easily readable markings in liters, millilitres, ounces and cups



### Juego 3 jarras medidoras

Ensemble de 3 pot mesureur  
3-tlg. Satz Messbecher  
3 piece measuring jugs  
Jogo 3 jarras de medidas

Ref	€	L	U.Venta
67131	15,20	0,25-0,5-1,0	1





# Set de medición EXACT

new

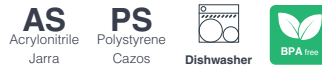

Raspador · Scraper

6 cazos medidores

6 measuring cups  
(7,5 ml, 15 ml, 60 ml,  
85 ml, 125 ml, 250 ml)

Embudo · Funnel

Jarra medidora

Measuring jug  
(1,0 L / 4 cups)



9  
pcs

## Set de medición EXACT

Set de mesure  
Messbecher-Set  
Measuring set  
Conjunto de medição



Compacto  
Compact

Ref	€	cm	h (cm)	L	U.Venta
62740	16,00	20x11	13,6	1,0	1

- Todas las piezas fabricadas en materiales de máxima calidad, libres de BPA.
- Versátil. Ideal para ingredientes líquidos y secos.
- Jarra con sistema de lectura rápida en litros y cups. Permite comprobar el nivel del líquido mientras se está vertiendo el contenido.
- Cazos marcados en ml y bps para una rápida identificación.

· Toutes les pièces sont fabriquées avec des matériaux de la plus grande qualité, sans BPA.

· Polyvalent, idéal pour les ingrédients liquides et secs.

· Pichet avec système de lecture rapide en Litres et Cups. Permet de vérifier le niveau du liquide tout en versant le contenu.

· Cuillères marquées en ml et bps pour une identification rapide.

· Alle Teile des Sets sind aus Materialien bester Qualität hergestellt, BPA-frei.

· Vielseitig einsetzbar, ideal für flüssige und trockene Zutaten.

· Messkanne mit gut lesbaren Markierungen in Liter und Cups. Füllstand beim Einfüllen der Flüssigkeit ablesbar.

· Löffel mit gut sichtbaren Markierungen in ml und bps.

· All parts made of top quality, BPA-free materials.

· Versatile: ideal for liquid and dry ingredients.

· Jug with easy to see quantities marked in litres and cups and easy to check liquid level while pouring contents.

· Ladles with ml and bps markings for easy reference.

· Todas as peças fabricadas em materiais da máxima qualidade, sem BPA.

· Colheres medidoras marcadas em ml e bps, para uma rápida identificação.

· Jarra com sistema de leitura rápida em litros e chávenas. Permite comprovar o nível do líquido enquanto se verte o conteúdo.

· Versátil, ideal para ingredientes líquidos e secos.

# Set medición & Bol PRACTIC

new



Jarra medidora · Measuring jug (0,5 L)

Jarra medidora · Measuring jug (1,0 L)

Escurreidor · Colander (2,0 L)

Bol mezclador · Mixing bowl (3,5 L)



· Práctico y versátil.

· Fabricadas en polipropileno de máxima calidad. 100% Libre de BPA.

· Jarras medidoras graduadas (mililitros /cups).

· Pequeño vertedor lateral para facilitar el vertido.

· Asas ergonómicas para facilitar el transporte.

· 100% estable gracias a los pies antideslizantes.

· Apilables, ocupan el mínimo espacio posible.

· Aptas para el lavavajillas.

· Pratique et versatile.

· Fabriqués en polypropylène de la plus grande qualité. 100% sans BPA.

· Verres doseurs gradués (millilitres /cups).

· Petit verseur latéral pour verser plus facilement.

· Poignées ergonomiques pour faciliter le transport.

· 100% stables grâce aux pieds antidérapants.

· Complètement empilables. Prenant ainsi une place très réduite.

· Compatibles lave-vaisselle.

· Practical and versatile.

· Made of top quality polypropylene. 100% BPA free.

· Measuring jugs with graduated ml and cup markings.

· Small side spout for easy pouring.

· Ergonomic handles for easy carrying.

· 100% with non-slip feet.

· Fully stackable. Up as little space as possible.

· Dishwasher safe.

## Set 4 boles PRACTIC

Ensemble de 4 récipients  
Schüsseln, 4er-Set  
Set of 4 bowls  
Conjunto de 4 tigelas

Ref	€	Ø (cm)	h (cm)	L	U.Venta
62633	35,10	11,5	9,3	0,5	1
		14,5	10,6	1,0	
		18,5	13,0	2,0	
		22,0	15,0	3,5	

# Colección BOLES PP

new



**Pico vertedor. Vierte el contenido sin derrames**  
Pouring spout. Pour the content no spills

**Pestaña de agarre antideslizante**  
Non-slip grip



## Set 3 boles GREY

Ensemble de 3 récipients  
Schüsseln, 3er-Set  
Set of 3 bowls  
Conjunto de 3 tigelas

**Base 100% antideslizante**  
100% non-slip base

Ref	€	Ø (cm)	h (cm)	L	U.Venta
60054	41,80	21,0	12,5	1,4	1
		26,0	14,2	2,8	
		31,2	14,8	4,7	

- Set de 3 boles de polipropileno de máxima calidad, 100% libres de BPA.
- Versátiles: ideales para mezclar, batir, preparar masas y servir ensaladas o salsas.
- Compuesto por 3 boles perfectamente apilables entre sí.
- Dispone de pico vertedor y pestaña de agarre antideslizante. Base 100% antideslizante.
- Fácil limpieza. No aptos para el lavavajillas.

- Ensemble de 3 bols en polypropylène de la plus grande qualité, 100% sans BPA.
- Polyvalents : parfaits pour mélanger, battre, préparer des pâtes et servir des salades ou des sauces.
- Composé de 3 bols parfaitement empilables entre eux.
- Bec verseur et poignée antidérapante pour une meilleure prise en main. Fond 100% antidérapant.
- Nettoyage facile. Ne convient pas au lave-vaisselle.

- Set of 3 top quality BPA-free polypropylene bowls.
- Versatile: ideal for mixing, whisking, making doughs and serving salads or sauces.
- Comprises 3 perfectly stackable bowls.
- Featuring a pouring spout and non-slip grip. 100% non-slip base.
- Easy to clean. Not suitable for the dishwasher.



**Tapas**  
Lids



## Set 6 boles MULTI

Ensemble de 6 récipients  
Schüsseln, 6er-Set  
Set of 6 bowls  
Conjunto de 6 tigelas

Ref	€	Ø (cm)	h (cm)	L	U.Venta
60055	20,00	10,0	5,0	0,25	1
		14,0	6,8	0,80	
		17,0	8,0	1,15	
		20,3	9,5	2,00	
		24,3	11,0	3,35	
		28,3	12,5	5,25	

- Set de 6 boles de polipropileno de máxima calidad, 100% libres de BPA.
- Versátiles: ideales para mezclar, batir, preparar masas, servir ensaladas o salsas.
- Compuesto por 6 boles perfectamente apilables entre sí.
- Incluye 6 tapas fabricadas en polipropileno, libres de BPA.
- Perfectos para almacenar y conservar los alimentos.
- Fácil limpieza. Cuerpos aptos para el lavavajillas.

- Lot de 6 bols avec couvercles en polypropylène de qualité supérieure, sans BPA.
- Polyvalents : parfaits pour mélanger, battre, préparer des pâtes et servir des salades ou des sauces.
- Composé de 6 bols parfaitement empilables entre eux.
- Comprend 6 couvercles en polypropylène, sans BPA.
- Parfait pour stocker et conserver les aliments.
- Facile à nettoyer. Bols aptes pour le micro-ondes et le lave-vaisselle.

- Set of 6 bowls with lids made of top quality 100% BPA-free polypropylene.
- Versatile: ideal for mixing, whisking, making doughs, serving salads or sauces.
- Comprises 6 perfectly stackable bowls.
- Includes 6 lids made of polypropylene, BPA free.
- Perfect for storing and preserving food.
- Easy to clean. Microwave and dishwasher safe bodies.

# Colección BOLES INOX

Inox



- Set de 3 boles de acero inoxidable de máxima calidad.
- Acabado interior y exterior satinado.
- Versátiles: ideales para mezclar, batir, preparar masas y servir ensaladas o salsas.
- Perfectos para almacenar y conservar los alimentos.
- Compuesto por 3 boles perfectamente apilables entre sí.
- Base 100% antideslizante.
- Incluye 3 tapas herméticas fabricadas en polipropileno, libres de BPA.
- Marcaje de capacidad en el interior (L).
- Fácil limpieza. No aptos para el lavavajillas.

- Ensemble de 3 bols en acier inoxydable de la plus grande qualité.
- Finition intérieure et extérieure satinée.
- Polyvalents : parfaits pour mélanger, battre, préparer des pâtes et servir des salades ou des sauces.
- Parfaits pour ranger et conserver les aliments.
- Composé de 3 bols parfaitement empilables entre eux.
- Fond 100% antidérapant.
- Inclut 3 couvercles hermétiques fabriqués en polypropylène, sans BPA.
- Marquage de capacité à l'intérieur (L).
- Nettoyage facile. Ne convient pas au lave-vaisselle.



- Set of 3 top quality stainless steel bowls.
- Inner and outer satin finish.
- Versatile: ideal for mixing, whisking, making doughs and serving salads or sauces.
- Ideal for storing and preserving food.
- Comprises 3 perfectly stackable.
- 100% non-slip base.
- Includes 3 airtight lids made of BPA-free polypropylene.
- Capacity marks inside (L).
- Easy to clean. Not suitable for the dishwasher.

new



PP



Polypropylene

## Set 3 boles INOX

Ensemble de 3 récipients  
Schüsseln, 3er-Set  
Set of 3 bowls  
Conjunto de 3 tigelas



Ref	€	Ø (cm)	h (cm)	L	U.Venta
60050	46,10	16	10,0	1,5	1
		18	11,0	2,2	
		20	12,5	3,0	

PP



Polypropylene

## Set 3 boles INOX

Ensemble de 3 récipients  
Schüsseln, 3er-Set  
Set of 3 bowls  
Conjunto de 3 tigelas

Ref	€	Ø (cm)	h (cm)	L	U.Venta
60051	62,10	20	12,5	3,0	1
		22	13,5	3,8	
		24	14,0	4,8	

## Bol cónico

Bol conique  
Schüssel, konisch  
Conical mixing bowl  
Bacia cônica

Ref	€	Ø (cm)	h (cm)	L	U.Venta
14016	3,80	16	6,5	0,90	12
14019	5,20	20	7,5	1,40	12
14025	9,40	24	9,0	2,50	1
14029	12,80	30	11,0	4,30	1
14033	17,80	34	13,5	7,50	1
14040	22,70	40	15,5	11,50	1
14046	32,20	45	17,5	17,40	1
14049	37,80	50	19,0	22,60	1

new  
new  
new

**GAR INOX**



**Diseño cónico con base estable**  
Conical design with stable base

# Colección CALDEROS INOX



## Caldero semiesférico sin asas

Bassine hemispherique s/anses  
Schneeschlagkessel ohne Griffe  
Semi-spherical mixing bowl wout/handles  
Bacia semi-esférica sem asas

Ref.	€	Ø (cm)	h (cm)	L	U.Venta
50323S	36,50	22	11,0	2,70	1
50327S	42,60	26	13,0	4,00	1
50333S	57,20	32	17,0	9,50	1
50337S	64,90	36	18,0	12,00	1
50341S	108,90	40	21,0	14,50	1

- Ideal para mezclar los alimentos.
- Para uso profesional o doméstico.
- Fabricados en acero inoxidable 18/10, material muy resistente a la corrosión y ácidos alimentarios.
- Fácil limpieza: apto para el lavavajillas.

- Idéal pour mélanger les aliments.
- Pour un usage professionnel ou domestique.
- Fabriqué en acier inoxydable 18/10, un matériau hautement résistant à la corrosion et aux acides alimentaires.
- Nettoyage facile : passe au lave-vaisselle.

- Ideal zum Mischen von Speisen.
- Für den professionellen oder privaten Gebrauch.
- Hergestellt aus Edelstahl 18/10, einem Material mit hoher Beständigkeit gegen Korrosion und Lebensmittelsäuren.
- Einfache Reinigung: Spülmaschinenfest.

- Ideal for mixing food.
- For professional or home use.
- Made of 18/10 stainless steel, a material highly resistant to corrosion and food acids.
- Easy cleaning: dishwasher safe.



## Caldero semiesférico c/asas

Bassine hemispherique a/anses  
Schneeschlagkessel mit Griffe  
Semi-spherical mixing bowl w/handles  
Bacia semi-esférica com asas

Ref.	€	Ø (cm)	h (cm)	L	U.Venta
50323	48,10	22	11,0	2,70	1
50327	54,70	26	13,0	4,00	1
50333	70,30	32	17,0	9,50	1
50337	75,60	36	18,0	12,00	1
50341	108,10	40	21,0	14,50	1

- Ideal para misturar alimentos.
- Para uso profesional o doméstico.
- Fabricado em aço inoxidável 18/10, um material altamente resistente à corrosão e aos ácidos alimentares.
- Fácil limpeza: lavável na máquina de lavar louça.



## Caldero cónico

Bassine conique  
Wanne  
Mixing bowl  
Bacia cónica

Ref	€	Ø (cm)	h (cm)	L	U.Venta
60013	12,40	13	6,1	0,55	1
60016	13,40	16	9,1	1,00	1
60020	18,40	20	11,7	2,12	1
60024	22,10	24	12,6	3,50	1
60028	27,60	28	13,4	5,25	1
60032	31,00	32	15,0	7,65	1
60036	42,90	36	16,0	11,00	1
60040	49,80	40	18,0	15,00	1

## Soporte de calderos s/esféricos

Support cul de poule  
Ringständer  
Bowl stand  
Suporte de bacias semi-esféricas



Ref.	€	U.Venta
50300	25,70	1



## Cubo

Seau.  
Eimer  
Pail  
Balde



Ref	€	Ø (cm)	h (cm)	L	U.Venta
14114	9,30	16-12	15,5	1,40	1
14119	17,60	20-15	20,0	4,60	1
14124	21,90	24-17,2	20,5	5,60	1
14128	39,80	28-21	25,8	14,00	1

## Caldero cónico con asas

Bassine conique à anses  
Wanne mit Griffe  
Conical mixing bowl  
Bacia cónica con asas



Ref.	€	Ø (cm)	h (cm)	L	U.Venta
50828	43,10	28	13,2	5,00	1
50832	47,80	32	14,5	7,00	1
50836	54,70	36	16,0	11,00	1
50840	60,80	40	18,0	15,00	1
50845	72,60	45	20,0	22,00	1
50850	87,10	50	21,0	30,00	1

# Colección **ESCURRIDORES**

Inox  
18/10



Dishwasher

Inox



## Escurridera con base

Passoire sur pied  
Abtropfschüssel mit Fussreif  
Colander with stand  
Escorredora com base



Ref.	€	Ø (cm)	h (cm)	L	U.Venta
50332	216,80	32	18	9,5	1
50336	263,50	36	19	12,0	1
50340	308,70	40	21	14,5	1

## Escurridera

Passoire  
Abtropfschüssel  
Colander  
Escorredor



Ref	€	Ø (cm)	L	U.Venta
14122	18,40	22	3,0	1
14125	22,60	25	5,0	1
14130	32,70	30	8,0	1

## Escurridera cónica con base

Passoire conique sur pied  
Abtropfschüssel  
Conical colander with stand  
Escorredor cónico com base



Ref	€	Ø (cm)	h (cm)	L	U.Venta
50829	70,70	28	17	13,2	1
50833	77,60	32	20	14,5	1
50837	88,40	36	23	16,0	1
50841	95,70	40	26	18,0	1
50846	109,70	45	29	20,0	1
50851	124,80	50	33	22,0	1

Varillas extensibles  
Extendable rods



## Escurridor extensible para fregadera

Passoire extensible pour l'évier  
Spülbank-Sieb, ausziehbar  
Extensible sink strainer  
Escorredor extensível para bancada

Ref	€	cm	Max (cm)	U.Venta
62987	24,00	34x24	55x24	1

Malla metálica donde se depositan los alimentos  
Metal mesh where food is deposited

Agujeros · Holes  
1x1 cm

## Escurrefritos

Passoire a friture  
Abtropfschüssel für Frittiertes  
Fry colander  
Escorre-fritos

Recipiente donde se recoge el aceite sobrante  
Container where excess oil is collected

Ref.	€	cm	h (cm)	U.Venta
50541	181,30	40x29	8,0	1
50551	213,90	50x39	8,0	1
50561	245,70	60x39	8,0	1

Asas robustas  
Robust handles



Ayuda a preparar rebozados perfectos  
Helps prepare perfect batters



## Harinero

Tamis à farine à glissière  
Mehlbehälter  
Flour bin mesh  
Farinheiro

Harina tamizada, para su recuperación  
Sifted flour, for its recovery

Ref.	€	cm	h (cm)	U.Venta
50438	162,70	37x26,5	18	1
50450	167,90	50x26,5	18	1



# Colección COLADORES

Inox  
18/10



Dishwasher



- Ideales para colar todo tipo de líquidos (tés, caldos, salsas), alimentos (pasta, arroz, verdura) y hasta tamizar ingredientes.
- Disponen de gancho de sujeción.
- Aptos para el lavavajillas.

- Idéales pour filtrer tout type de liquides (thé, bouillons, sauces) et égoutter toute sorte d'aliments (pâtes, riz, légumes), et même tamiser des ingrédients.
- Dispose d'un crochet de fixation.
- Aptes pour aller au lave-vaisselle.

- Ideals zum Abseihen von Flüssigkeiten (Tees, Brühen, Saucen) und Festem (Pasta, Reis, Gemüse) und auch zum Trennen von Zutaten.
- Mit Haken zum Aufhängen.
- Spülmaschinengeeignet.

- Ideals for straining all types of liquids (teas, broths, sauces), food (pasta, rice, vegetables) and even for sifting ingredients.
- Complete with hanging hook.
- Dishwasher safes.

- Ideales para coar todo o tipo de líquidos (chá, caldos, molhos), alimentos (pasta, arroz, verdura) e para peneirar ingredientes.
- Com gancho de sujeição.
- Aptos para a máquina de lavar louça.



Dishwasher

## Mano chino en haya

Poussoir á chinois en hêtre

Holz-Stössel, Buche

Chinese strainer pusher in beech wood

Pilão p/passador chinês em faia



Ref	€	L (cm)	U.Venta
60300	6,10	25	1

## Posibilidad de completar colador en 4 sectores solicitando 4 unidades

Possibility of completing strainer in 4 sectors requesting 4 units



## Colador

Passoire

Teigwaren-Einsatz

Colander

Coador

Ref.	€	Ø (cm)	h (cm)	U.Venta
50334	69,50	36	23,0	1
50338	84,20	40	26,0	1

Precio unitario · Unit price

## Colador

Passoire à queue

Seiher mit Stiel

Strainer

Coador



Ref.	€	Ø (cm)	h (cm)	L	U.Venta
50320	55,70	20	12	3,5	1
50324	63,50	24	14	6,5	1
50328	74,40	28	15	9,3	1

## Colador chino

Passoire "Chinois"

Spitzsieb mit Flachstiel

"Chinese" strainer

Passador chinês



Ref	€	Ø (cm)	U.Venta
60311	17,30	10	1
60313	17,80	12	1
60315	18,70	14	1
60317	20,40	16	1
60318	21,60	18	1
60320	23,40	20	1
60322	25,40	22	1
60324	26,70	24	1
60326	28,60	26	1



### Colador chino m/varilla c/pestaña

Passoire "Chinois" manche fil  
Spitzsieb mit Rundstiel  
Wire handle "Chinese" strainer  
Passador chinês cabo vareta com suporte

Ref	€	Ø (cm)	U.Venta
60316P	17,10	16	1
60318P	18,30	18	1
60320P	19,70	20	1
60322P	22,30	22	1
60324P	23,80	24	1



### Colador chino mango varilla s/pestaña

Passoire "Chinois" manche fil  
Spitzsieb mit Rundstiel  
Wire handle "Chinese" strainer  
Passador chinês cabo vareta sem suporte

Ref	€	Ø (cm)	U.Venta
60316V	17,80	16	1
60319V	20,20	20	1



### Colador chino de malla

Passoire "Chinois" toile-metallique  
Gazespitzsieb  
Meshed "Chinese" strainer  
Coador chinês de rede

Ref	€	Ø (cm)	U.Venta
60319	27,80	18	1
60321	34,50	20	1
60323	34,90	22	1
60325	38,30	24	1



### Colador malla con refuerzo

Chinois toile-metallique a croissillon  
Gewebedurchschlang, konisch, verstärkt  
Conical mesh strainer w/protec tion  
Coador de rede com reforço

Ref.	€	Ø (cm)	U.Venta
62621	52,80	20x22	1



### Colador cónico

Passoire conique  
Passiersieb, konisch  
Conical sieve  
Coador cónico

Ref	€	Ø (cm)	U.Venta
62690	7,00	8	1
62611	9,20	10	1
62613	11,70	12	1
62615	14,50	14	1
62617	17,00	16	1
62619	19,50	18	1

### Colador 1/2 esfera

Passe-bouillon  
Passiersieb  
Sieve  
Coador 1/2

Ref	€	Ø (cm)	U.Venta
62680	5,20	8	1
62610	8,70	10	1
62612	11,20	12	1
62614	12,90	14	1
62616	15,20	16	1
62618	17,80	18	1
62620	23,10	20	1
62623	27,70	23	1



Inox **PP**  
Polypropilene **BPA free**

### Colador DRAIN

Passe-bouillon  
Passiersieb  
Sieve  
Coador

Ref	€	Ø (cm)	U.Venta
62697	5,20	7,5	6
62691	7,80	12,0	6
62698	12,40	18,0	1
62692	14,20	22,0	1

**PE**  
Polyethilene **BPA free**

### Triangulo

Triangle  
Dreieck  
Triangle  
Triângulo

Ref.	€	h (cm)	mm	U.Venta
60402	55,30	2	400	1

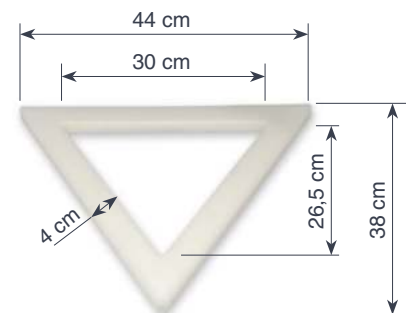

# Colección EMBUDOS

Inox  
18/10  
Dishwasher



Ranura de desgasificación  
Degassing groove



Filtro  
Filter



Tapón  
Cap

## Embudo

Entonnoir  
Trichter  
Funnel  
Funil

Ref	€	Ø (cm)	U.Venta
62512	15,70	12	1
62516	22,70	16	1
62521	29,40	20	1
62524	32,90	24	1

SI 180°C  
Silicone max BPA free

## Embudo expandible

Entonnoir extensible  
Trichter  
Foldable funnel  
Funil extensível

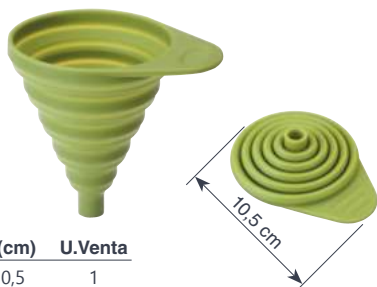

Ref	€	Ø (cm)	h (cm)	U.Venta
68085	5,90	8	10,5	1



Cuello ancho para verter con mayor rapidez en tarros/botellas sin riesgo de quemaduras.  
Wide neck for faster pouring into jars / bottles without risk of burns.

Filtro extraíble  
Removable filter



## Embudo con filtro

Entonnoir à filtre mobile  
Trichter mit Sieb  
Funnel with movable filter  
Funil com filtro

Ref	€	Ø (cm)	A (Ø cm)	U.Venta
62531	12,80	10	1,2	1
62513	15,00	12	1,5	1
62515	17,20	14	1,5	1



Ranura de desgasificación  
Degassing groove

## Embudo mermelada

Entonnoir à confiture  
Mermeladentrichter  
Funnel for jam  
Funil de congestionamento



Ref	€	Ø (cm)	h (cm)	A (Øcm)	U.Venta
62517	10,00	13,5	6,5	6	1

# Colección HERVIDORES

Inox  
18/10  
Dishwasher



## Hervidor extensible

Panier marguerite extensible  
Kocher, ausdehnbar, Rostfrei  
Extensible steamer  
Grelha extensível



Ref	€	Ø (cm)	U.Venta
60349	6,70	24	12
60348	9,80	28	6



## Cuece especias

Diffuseur épices  
Kräuterkochsieb  
Spice cooker  
Cozedor de especiarias



Ref	€	Ø (cm)	h (cm)	U.Venta
62958	12,30	4	15,4	1

## Cacerola vapor

Panier vapeur  
Dampfkoch-Aussatz o/Untertopf  
Steam casserole  
Caçarola a vapor



Ref	€	Ø (cm)	h (cm)	U.Venta
50428	58,90	28	11,0	1
50432	65,00	32	12,5	1

## Hervidor pescado

Poissonniere avec grille  
Fischkochkessel mit Einsatz  
Fish kettle with grill  
Peixeira



Ref.	€	cm	h (cm)	L	U.Venta
50440	102,80	40x19	11	10,05	1
50445	108,50	50x17	11	13,80	1
50460	141,70	60x19	11	20,80	1



# Colección CORTADORES



- Picadora de mecanismo manual que pica todo tipo de alimentos, como verduras, frutas, frutos secos, dátiles, jengibre, ajo, cebolla, hierbas, etc.
- Incluye tres potentes cuchillas ultrarresistentes fabricadas en acero inoxidable de máxima calidad.
- Ajuste de dos velocidades: velocidad baja (I) para cortar y picar más grueso y velocidad alta (II) para un corte y picado más fino (60599).
- Práctico y muy fácil de usar: con tal solo tirar del asa las cuchillas se activan.
- Corta con precisión y homogéneamente.
- Asa ergonómica y base antideslizante 100% segura.
- Ocupa poco espacio ya que su asa-tirador se pliega sobre la tapa de la picadora.
- Pequeño, compacto y muy fácil de limpiar.

- Hachoir à mécanisme manuel qui hache tout type d'aliments, comme les légumes, les fruits secs, les dattes, le gingembre, l'ail, les oignons, les herbes, etc.
- Il possède trois puissantes lames ultra-résistantes fabriquées en acier inoxydable de la plus grande qualité.
- Réglage de deux vitesses: Vitesse faible (I) pour couper et hacher plus épais, et vitesse haute (II) pour couper et hacher plus finement (60599).
- Pratique et très facile à utiliser : il suffit de tirer de la poignée pour activer les lames.
- Coupe avec précision et de façon homogène.
- Poignée ergonomique et base antidérapante 100% sûre.
- Prend peu de place car sa poignée se replie sur le couvercle du hachoir.
- Petit, compact et très facile à nettoyer.

- Manual chopper that chops all kinds of food, like vegetables, fruit, nuts, dates, ginger, garlic, onion, herbs, etc.
- It includes three ultra-strong blades made of top quality stainless steel.
- There are two speed settings: Low speed (I) is for cutting and chopping more coarsely and high speed (II) is for cutting and chopping more finely (60599).
- Practical and very easy to use: The blades are activated by simply pulling the handle.
- It cuts precisely and evenly.
- It has an ergonomic handle and a 100% safe non-slip base.
- It doesn't take up much space because the handle-pull folds onto the chopper lid.
- It's small, compact and very easy to clean.

**Pica y corta alimentos en segundos**  
It chops and slices foods in seconds

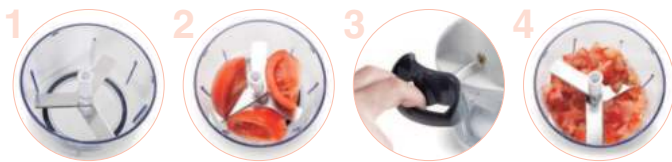

**3 cuchillas ultrarresistentes**  
3 ultra-strongs blades

**5 cuchillas ultrarresistentes**  
5 ultra-strongs blades



## Cortador manual SHARP

Coupe manuel  
Manueller Schneider  
Manual cutter  
Cortador manual

	Ref	€	Ø (cm)	h (cm)	L	U.Venta
A	60299	21,10	12	11	0,5	1
B	60499	22,40	13	14	1,0	1

**II Velocidad I - Speed I**  
**Corta y pica más grueso**  
I Cut and chopp more coarsely

**II Velocidad II - Speed II**  
**Corta y pica más fino**  
I Cut and chopp more finely



**Cuchillas SpinPro ultrarresistentes de acero inoxidable**

SpinPro blades ultra-resistant stainless steel

## Cortador manual AFFILATO

Coupe manuel  
Manuelle Schneider  
Manual chopper  
Cortador manual

	Ref	€	Ø (cm)	h (cm)	L	U.Venta
	60599	24,90	13	14	1,2	1



## Cortador de verdura y chips

Coupe de légumes  
Gemüseschneidemaschine  
Chips and vegetable cutter  
Cortador de verdura e chips

Ref	€	cm	h (cm)	U.Venta
60344	45,30	11,5x21,5	11	1

Cuchillas de acero inoxidable de alta calidad  
High quality wear resistant stainless steel blades

3 cuchillas (6 - 9 - Rodajas 6 mm)  
3 blades (6 - 9 - Slice 6 mm)

2 empujadores.  
Fácil de colocar  
2 pushers. Easy to place

Contenedor para almacenar los alimentos  
Food storage container

Bloque empujador  
Pusher block

Peines de limpieza  
Cleaning combs



Pinchos de acero inoxidable 18/10  
18/10 stainless-steel skewers

Mango antideslizante  
Non-slip handle

Inox 18/10 ABS  
Plastic

## Cortador de patatas HASSELBACK

Coupe-pommes de terre Hasselback  
Hasselback-Kartoffelschneider  
Hasselback potato slicer  
Cortador de batatas Hasselback

Ref	€	cm	h (cm)	U.Venta
68180	9,60	18x10	2,1	1



- 2 en 1: cortador de verduras y cortador para preparar patatas Hasselback.
- Ideal para cortar en rodajas cualquier tipo de alimento como patata, cebolla, tomate, pepino, zanahoria e incluso carne y pescado.
- Mango antideslizante para un agarre firme y pinchos que guían el cuchillo para un corte perfecto y uniforme.
- Fácil de limpiar. Apto para el lavavajillas.

- 2 en 1 coupe-légumes et coupe-pommes de terre pour préparer des pommes de terre Hasselback.
- Idéal pour couper en rondelles tout type d'aliments comme les pommes de terre, les tomates, les concombres, les carottes et même la viande et le poisson.
- Manche antidérapant pour une prise en main ferme et des pointes qui guident le couteau pour une découpe parfaite et uniforme.
- Facile à nettoyer. Convient au lave-vaisselle.

- 2 in 1: vegetable slicer and Hasselback potato slicer.
- Ideal for slicing any type of food such as potatoes, onions, tomatoes, cucumbers, carrots and even meat and fish.
- Non-slip handle for a firm grip and skewers that guide the knife for perfect and even slicing.
- Easy to clean. Suitable for the dishwasher.

2 in 1

ABS  
Plastic

## Deshojador de hierbas aromáticas

Effeuilleuse à herbes aromatiques  
Entblätterer für gewürzkräuter  
Aromatic herb stripper  
Desfolhador de ervas aromáticas

Ref	€	cm	U.Venta
61359	6,50	16,5x7,5x2	1

Separador de hojas  
Separating leaves

Parte aguda para cortar  
Sharp part for cutting



- Funcionamiento sencillo; insertar el tallo en el agujero que mejor se adapte y deslizar la rama en dirección contraria.
- Contiene agujeros de distinto tamaños:
  - Los pequeños para deshojar hierbas aromáticas como el romero, orégano, tomillo estragón, etc.
  - Los más grandes para separar el tallo más duro que tienen algunas verduras de la hoja como las acelgas, espinacas, col rizada, etc.
- Gracias a la parte más aguda, se pueden cortar las hojas con el mismo utensilio.

- Fonctionnement simple : insérer la tige dans le trou qui s'adapte le mieux et faire glisser la branche dans le sens contraire.
- Contient des trous de différentes tailles :
  - Les petits; servent à effeuiller les herbes aromatiques telles que le romarin, l'origan, le thym, l'estragon, etc.
  - Les plus grands; servent à séparer la tige plus dure de certains légumes comme les blettes, les épinards, le chou frisé, etc.
- Grâce à la partie plus pointue, les feuilles peuvent être coupées avec le même ustensile.

- Easy to use. Put the stalk into the hole where it fits best and pull the herb in the opposite direction.
- There are different sized holes:
  - The small holes are for stripping leaves from aromatic herbs like rosemary, oregano, thyme, tarragon, etc.
  - The bigger holes are for separating harder stalks found in some leafy vegetables like chards, spinach, kale, etc.
- With the sharp end you can use the same utensil to cut leaves.

# Colección PICADORES

Inox  
18/10



- Picadora de mecanismo manual que pica todo tipo de alimentos, como verduras, frutas, jengibre, ajo, cebolla, frutos secos y hierbas.
- Cuchilla de acero inoxidable de máxima calidad.
- Recipiente transparente para visualizar el proceso. Libre de BPA.
- Muy fácil y cómodo de usar gracias a su sistema manual PressTurn.
- Tapa de polietileno antideslizante para facilitar la tarea y evitar desplazamientos.
- Fácil de desmontar y limpiar.

- Hachoir à mécanisme manuel qui hache tout type d'aliments, comme les légumes, les fruits, le gingembre, l'ail, l'oignon, les fruits secs et les herbes.
- Lame en acier inoxydable de la plus grande qualité.
- Récipient transparent. Sans BPA.
- Très facile et pratique à utiliser grâce à son système manuel **PressTurn**.
- Couverture antidérapante pour faciliter la tâche et éviter les glissements.
- Facile à démonter et à nettoyer.

- Handschneider zum Zerkleinern von Gemüse, Obst, Ingwer, Knoblauch, Zwiebeln, Dörrobst, Kräutern usw.
- Messer aus rostfreiem Stahl bester Qualität.
- Arbeitsfortschritt im Klarsichtbehälter zu sehen. Ohne BPA.
- Einfach und bequem per **PressTurn** von Hand zu bedienen.
- Müheloses und sicheres Arbeiten dank rutschfestem Deckel.
- Teile einfach abnehmbar und zu reinigen.

- Hand-operated food processor for chopping all types of food, such as vegetables, fruit, ginger, garlic, onion, nuts and herbs.
- Top quality stainless steel blade.
- Transparent jar for easy viewing. BPA free.
- Very simple, easy to use manual **PressTurn**.
- Non-slip lid to simplify the process and avoid slipping.
- Easy to dismantle and clean.

- Picadora de mecanismo manual para picar todo o tipo de alimentos, como verduras, frutas, gengibre, alho, cebola, frutos secos e ervas aromáticas.
- Lâmina de aço inoxidável da máxima qualidade.
- Recipiente transparente para visualizar o processo. Não contém BPA.
- Muito fácil e cómodo de usar, graças ao seu sistema manual **PressTurn**.
- Tampa antideslizante, para facilitar o trabalho e evitar deslizamentos.
- Fácil de desmontar e de limpar.



Diseño compacto  
Compact design



## Picadora manual PRESS

Hachoir manuel  
Handschneider  
Manual food chopper  
Picador manual

Ref	€	Ø (cm)	h (cm)	U.Venta
62819	35,70	9,4	22,7	1

## Picadora manual

Hachoir manuel  
Handschneider  
Manual food chopper  
Picador manual

Ref	€	Ø (cm)	h (cm)	U.Venta
62980	31,90	9,5	22	6



## Picaperejil

Hachoir à manivelle pour fines herbes  
Kräutermühle, fein, Rostfrei  
St. steel fine herbs mincer  
Pica-salsa



Ref	€	cm	U.Venta
60334	22,30	13,5x20x7,5	1

## Inox

## Picadora de carne manual

Hachoir avec manivelle  
Fleischwolf mit handkurve  
Meat mincer  
Picadora de carne manual



Ref	€	cm	U.Venta
60329	123,80	17x12x19	1

**Mecanismo de manivela que requiere muy poca fuerza**  
Crank mechanism requiring very little force

**Multifuncional: pica, bate y centrifuga**  
Multifunctional: chop, beat and spin



### Mini picadora-batidora manual

Mini hachoir-fouet manuel  
Minizerhacker-Schneebesens  
Manual mini chooper-whisk  
Mini picadora-batedeira manual

Ref	€	Ø (cm)	L	U.Venta
60361	18,10	Ø17x18	1,00	1

**Sistema TurnCut**  
**Accionamiento manual de la manivela**  
TurnCut System  
Manual crank operation

**Cuchillas de acero inoxidable**  
Stainless steel blades

**El empujador facilita y agiliza el proceso**  
The pusher, facilitates and speeds up the process



**100% estable. Sujeción mediante ventosa**  
100% stable  
Suction cup fastening

**Inox**  
**ABS**  
Plastic

### Picadora

Mincer  
Fleischwolf  
Hachoir  
Picadora

Ref	€	cm	U.Venta
60340	34,70	18x22	1

## Garras de OSO

**Inox**

Baquelita  
Bakelite  
Mangos  
Handles



Dishwasher

**Manipula carnes**  
Manipulate meat



**Desmenuza carnes**  
Crumble meats



- Fabricadas en acero inoxidable de máxima calidad.
- Diseñadas para desmenuzar y manipular carnes hechas al horno o barbacoa, como pollo, carne de vacuno, pavo, aves, jamón, etc.
- Puntas afiladas para manipular la carne sin esfuerzo. Forma curvada para un mejor agarre y mayor comodidad.
- Mangos ergonómicos de baquelita resistentes al calor, 100% seguros.
- Multifuncional: desmenuza y traslada la carne, facilita la sujeción para cortes con cuchillo, remueve las ensaladas o pastas, etc.
- Fácil de limpiar. Aptas para el lavavajillas.

- Fabriquées en acier inoxydable de la plus grande qualité.
- Conçues pour émincer et manipuler des viandes cuites au four ou au barbecue comme du poulet, du boeuf, de la dinde, de la volaille, du jambon, etc.
- Pointes aiguisées pour manipuler la viande sans effort. Forme courbée pour une meilleure prise en main et un plus grand confort.
- Poignées ergonomiques en bakélite résistantes à la chaleur, 100% sûres.
- Multifonctions : émincer et transférer la viande, faciliter la prise en main pour une découpe au couteau, remuer les salades ou les pâtes, etc.
- Facile à nettoyer. Aptes pour le lave-vaisselle.

- Made of top quality stainless steel.
- Designed for shredding and handling baked or barbecued meats, such as chicken, beef, turkey, poultry, ham, etc.
- Sharp tips for easy handling of meats. Curved shape for better grip and comfort.
- Ergonomic heat-resistant Bakelite handles, 100% safe.
- Multifunctional: perfect for shredding, turning and holding meat in place while cutting it with a knife, ideal for mixing salads or pasta, etc.
- Easy to clean. Dishwasher safe.

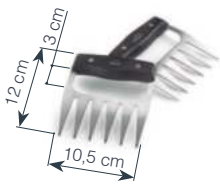

### Garras de oso para carne

Griffes à viande  
Fleisch Bärenkrallen  
Bear claws for meat  
Garras de urso para carne

Ref	€	cm	U.Venta
38015	12,70	10,5x12	1

# Triturador manual de TOMATE

new

Inox **ABS SAN LDPE**  
 Plastic Plastic Container Polyethylene Tapa/Lid **BPA free**



Incluye empujador  
Includes pusher

Salida de jugo, libre de pieles y semillas  
 Juice outlet with no peels or seeds



Salida para desechos  
 Outlet for waste



- Saca el máximo jugo a los alimentos, libre de pieles y semillas.
- Filtro de acero inoxidable de gran calidad y contenedor de polipropileno, libre de BPA.
- Superversátil: prepara salsas de tomate, purés de patata, mermeladas, conservas, etc. con un único aparato.
- Entrada de alimentación de gran capacidad.
- Dispone de un orificio de salida para desechos.
- 100% estable: sistema de sujeción mediante ventosa.
- Incluye empujador para facilitar y agilizar el procesado.
- Totalmente desmontable y fácil de limpiar.

- Recueillir au maximum le jus des aliments, sans peaux ni pépins.
- Filtre en acier inoxydable de grande qualité et conteneur en polypropylène, sans BPA.
- Très polyvalent: préparer des sauces tomate, des purées, des confitures, des conserves, etc. avec un seul appareil.
- Entrée d'aliments de grande capacité.
- Dispose d'un orifice de sortie pour déchets.
- 100% stable : système de fixation via des ventouses.
- Inclut un poussoir pour faciliter et accélérer le processus.
- Entièrement démontable et facile à nettoyer. Compatible lave-vaisselle.

- Designed to get the most juice out of food with no peels or seeds.
- It has a high quality stainless steel filter and a BPA free polypropylene container.
- Extremely Versatile: make tomato sauces, potato purée, marmalade, preserves, etc. with a single appliance.
- High capacity food input
- It has an outlet for waste.
- 100% Stable: it has an attachment system that uses suction cups.
- A pusher is included to make processing food faster and easier.
- It can be completely disassembled and it's very easy to clean.

## Triturador manual de tomate

Presse-tomates manuel  
 Handpresse für Tomaten  
 manual tomato chopper  
 Triturador manual de tomate



Ref	€	U.Venta
60394	47,20	1

## Pasapurés INOX

Inox 18/10  
 Dishwasher

3 discos  
 3 discs



### Pasapurés

Presse-puree  
 Passiergerät  
 Potato mashing machine  
 Passa-puré

Ref	€	Ø (cm)	L	Ø Disco (cm)	U.Venta
60048	55,10	18	0,7	10,5	1
60027	72,40	24	1,5	13,5	1

2 discos  
 2 discs



### Pasapurés profesional

Presse-Puree  
 Passiergerät  
 Potato mashing machine  
 Passa-puré professionnel

Ref.	€	Ø (cm)	L	Ø Disco (cm)	U.Venta
60026	124,20	26	5,0	16,5	1
60031	129,80	32	8,0	16,5	1

2 discos  
 2 discs



### Pasapurés

Presse-puree  
 Passiergerät  
 Potato mashing machine  
 Passa-puré

Ref	€	Ø (cm)	L	Ø Disco (cm)	U.Venta
60030	82,40	30	3,5	16,5	1

2 discos  
 2 discs



### Pasapurés doméstico

Presse-Puree  
 Passiergerät  
 Home potato mashing machine  
 Passa-puré doméstico

Ref	€	Ø (cm)	L	Ø Disco (cm)	U.Venta
60021	55,90	20	1,5	11,5	1

# Prensadores INOX

Inox  
18/10



Dishwasher



## Prensador de patatas

Presse-purée  
Kartoffelpresse  
Potato masher  
Prensa-batatas

Ref	€	cm	h (cm)	U.Venta
62892	19,40	10,5x8,5	24	1



## Prensa patatas

Presse-pomme de terre  
Kartoffelpresse  
Potato press  
Esmaga-batatas

Ref	€	cm	U.Venta
62902	34,90	9x28x11	1



## Ablandacarne Inox

Attendrisseur à viande en Inox  
Fleischklopfen, Edelstahl  
St. steel meat tenderizer  
Ablandacarne Inóx

Ref	€	cm	U.Venta
60432	37,70	12x2	1



Pica y lamina  
Chop and slice

Zamak  
Zinc  
Alloy

## Prensa ajos y laminador

Presse ail coupe  
Knoblauchpresse, Schneider  
Garlic press and slicer  
Esmaga-alhos y laminador

Ref	€	L (cm)	U.Venta
60387	26,40	20	1

Accesorio para eliminar los restos  
Accessory for eliminating the remains

Liso para reducir el grosor de la carne.  
Rugoso para ablandar y para que penetre mejor los adobos

Smooth side, to reduce the thickness of the meat. Rough side for softening and better marinade penetration



Mango ergonómico y antideslizante  
Ergonomic non-slip handle

## Martillo ablandacarne

Marteau attendrisseur de viande  
Fleischklopfen Hammer  
Meat hammer tenderizer  
Martelo ablandador de carne

Ref	€	cm	U.Venta
60431	16,90	7x24	1



Resultados perfectos  
Empanadillas iguales y perfectamente selladas  
Perfect results. Equal and perfectly sealed dumplings

## Molde empanadillas

Moule à chaussons  
Pastetenformen  
Dumpling mould  
Forma para salgados

Ref	€	Ø (cm)	U.Venta
68101	20,90	10	1
68102	22,90	12	1



# Colección MORTEROS



**Granito de calidad PREMIUM**  
PREMIUM quality granite

- Fabricados en granito de calidad premium.
  - Interior no poroso, permite extraer los aceites naturales de las hierbas y especias.
  - El diseño de la mano permite maniobrar con facilidad y con poco esfuerzo.
  - Pesado y bien balanceado.
- Composé de granit de qualité supérieure.
  - Intérieur non poreux permettant d'extraire les huiles essentielles des herbes et épices.
  - La conception de la main facilite les manœuvres et réduit les efforts.
  - Lourd et bien équilibré.
- Manufactured from premium quality granite.
  - Interior not porous allowing extracting natural oils from herbs and spices.
  - The design of the hand allows easy manoeuvres with little effort.
  - Heavy and well balanced.

## PE

Polyethilene

### Mano mortero

Poussoir à mortier  
Stössel  
Pestle  
Pilão p/almofariz

Ref.	€	Ø (cm)	U.Venta
60401	39,20	Ø4,8x25	1



## PE

Polyethilene

### Mortero

Mortier  
Mörser  
Mortar  
Almofariz

Ref.	€	Ø (cm)	U.Venta
60403	160,70	18	1



### Mortero con mano de granito

Mortier et pilon en granit  
Mörser und Stössel aus Granit  
Granite mortar and pestles  
Argamassa e pilão do granito

	Ref	€	Ø (cm)	h (cm)	ml	U.Venta
<b>A</b>	60512	25,80	12	8	250	1
	60514	30,10	14	10	375	1
<b>B</b>	60516	31,30	16	12	600	1



### Mortero con mano de granito

Mortier et pilon en granit  
Mörser und Stössel aus Granit  
Granite mortar and pestles  
Argamassa e pilão do granito

	Ref	€	Ø (cm)	h (cm)	ml	U.Venta
<b>A</b>	60517	25,00	10,5	7,5	225	1
<b>B</b>	60518	25,40	12	12,0	365	1



# Prensa HAMBURGUESAS



## Paso a paso...



**ABS**

Plastic

## Prensa hamburguesas MULTI

Presse à hamburguers  
Hanburger-Formen  
Hamburg presser  
Moldes para hambúrgueres

Ref	€	Ø (cm)	U.Venta
60259	7,30	12,5x6	1
R60259A	1,40	10	1

60 separadores · separators



## 60258

- Molde de aleación de aluminio fundido de gran calidad con recubrimiento antiadherente.
- Pomo de madera desmontable y ergonómico, permite una distribución uniforme de la presión para crear hamburguesas caseras de carne, vegetarianas o veganas.
- Perfectas en proporción y consistencia.
- Superficie interior acanalada, proporciona un aspecto profesional.
- Incluye 60 unidades de papel antiadherente de Ø11 cm.
- Fácil de limpiar.

- Moule en alliage de fonte d'aluminium de grande qualité avec revêtement anti-adhésif.
- Pommeau en bois démontable et ergonomique, permet une distribution uniforme de la pression pour créer des steaks à hamburger maison de viande, végétariens ou végans.
- Proportion et consistance parfaites.
- Surface interne cannelée, qui confère un aspect professionnel.
- Comprend 60 unités de papier antiadhésif Ø11 cm.
- Facile à nettoyer.

- High quality cast aluminum alloy mold with non-stick coating.
- Removable ergonomic wooden handle, facilitates uniform distribution of pressure to make homemade beef, vegetarian or vegan burgers.
- Perfect proportions and consistency.
- Ribbed inner surface, provides a professional appearance.
- Includes 60 units of Ø11 cm non-stick paper.
- Easy to clean.

## 60259

- Fabricado en plástico ABS de alta calidad y durabilidad. Libre de BPA.
- Compuesto por 6 piezas totalmente desmontables.
- Versátil: ideal para preparar y rellenar todo tipo de hamburguesas.
- Base extraíble acanalada para facilitar la extracción de la hamburguesa.
- Compacto: se guarda en una sola pieza.
- Práctico y muy fácil de usar.
- Medidas (mm): hamburguesa grande Ø10x3 cm / mini Ø6,5x2 cm.
- Incluye 60 unidades de papel antiadherente de Ø10 cm.
- Fácil de limpiar. Apto para el lavavajillas.

- Fabriquée en plastique ABS d'une grande qualité et durabilité. Sans BPA.
- Composée de 6 pièces entièrement démontables.
- Polyvalente : Idéale pour préparer et garnir tout type de hamburgers.
- Base extractible cannelée pour faciliter l'extraction du steak.
- Compacte : Se range en une seule pièce.
- Pratique et très facile à utiliser.
- Dimensions (mm) : Grand steak Ø10x3 cm/Mini steak mini Ø6,5x2 cm.
- Comprend 60 unités de papier antiadhésif Ø10 cm.
- Facile à nettoyer. Apte pour le lave-vaisselle.

- Made of high quality, durable ABS plastic. BPA free.
- Comprised of 6 fully detachable parts.
- Fully versatile: perfect for making and filling all types of burgers.
- Detachable grooved base to simplify burger extraction.
- Compact: single piece storage.
- Very practical and easy to use
- Dimensions (in mm): Large burger Ø10x3 cm/Mini burger Ø6,5x2 cm.
- Includes 60 units of Ø10 cm non-stick paper.
- Easy to clean. Dishwasher safe.



**AL FU HAYA**

Aluminium Cast Beech wood

## Prensa hamburguesas

Presse à hamburguers  
Hanburger-Formen  
Hamburg presser  
Moldes para hambúrgueres

Ref	€	Ø (cm)	U.Venta
60258	14,60	11,5x7,5	1
R60258A	1,50	11	1

60 separadores · separators





# EXPRIMIDORES manuales

Inox  
18/10



Dishwasher



## Disfruta del zumo recién exprimido

Enjoy freshly squeezed juice

- Ideales para limas, limones, naranjas e incluso pomelos.
- Extraen el jugo sin cascara, pulpa y semillas.
- Idéales pour les citrons verts, les citrons jaunes, les oranges et même les pamplemousses.
- Extrait le jus sans peau, pilpe ou graines.
- Ideals für Limetten, Zitronen, Orangen und sogar Grapefruit.
- Entsaftet ohne Schale, Fruchtfleisch und Kerne.
- Ideals for limes, lemons, oranges and even grapefruit.
- Extracts the juice without peel, pulp and seeds.
- Ideales para limas, limoes, laranjas e pomelos.
- Extraí o sumo sem cascas, polpa ou sementes.

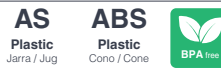

### Exprimidor con jarra medidora

Presse-citron avec pot mesureur  
Zitruspresse mit Mass Behälter  
Juicer with measuring jug  
Espresmedor com jarra de medidas

Jarra medidora (ml/cup)  
Measuring jug (ml/cup)

Ref	€	cm	h (cm)	L	U.Venta
67134	7,30	18,5 x 11	15	0,5	1

Tres salidas vertedoras  
Three pouring outlets

Medidor (ml/cup)  
Measure (ml/cup)



### Mini exprimidor

Mini presse-citron  
Minizitruspresse  
Mini squeezer  
Mini espresmedor

Ref	€	cm	h (cm)	ml	U.Venta
68181	6,40	10x9,5	8,5	70	1

### Exprimidor limón

Presse-citron  
Zitruspresse  
Lemón squeezer  
Espresmedor de limão



Ref	€	U.Venta
62946	11,70	1

Inox

### Exprimidor manual

Presse citron manuel  
Manuelle zitronenpresse  
Manual reamer  
Espresmedor manual



Ref	€	Ø (cm)	L	U.Venta
62952	17,60	10	0,15	6
62912	20,60	12	0,20	6

### Exprimidor

Presse-fruit  
Zitruspresse  
Citrus press  
Espresmedor



Ref	€	Ø (cm)	h (cm)	U.Venta
63912	12,70	4,5	16	1



## Exprimidor de zumo

Presse-fruits manuel  
Manuelle fruchtpresse  
Manual squeezer  
Espremedor de sumos



	Ref	€	cm	h (cm)	U.Venta
A	63913	58,30	21x18	21	1 <b>Bajo</b> · Low
B	63914	53,70	15x19	39	1 <b>Alto</b> · High

**AL**

Aluminium

## Exprimidor manual

Presse citron manuel  
Manuelle zitronenpresse  
Manual reamer  
Espremedor manual



**Ideal para limas, limones, naranjas e incluso pomelos**

Ideal for limes, lemons, oranges and even grapefruit

Ref	€	L (cm)	U.Venta
63915	11,10	22	1

## CONTENEDOR de alimentos

**PE** **ASA**  
Polyethylene Acrylic



1000 ml



750 ml



600 ml



450 ml

**Ideal para especias y condimentos**

Ideal for spices and condiments

## Contenedor alimentos con tapa

Boîte à condiments avec couvercle  
Gewürzkasten mit Deckel  
Condiments holder with lid  
Caixa condimentos com tampa



	Ref	€	cm	Cavidades	Unidad (ml)	U.Venta
A	61133	27,70	50x16x9	3	1000	1
B	61134	27,70	50x16x9	4	750	1
C	61135	27,70	50x16x9	5	600	1
D	61136	27,70	50x16x9	6	450	1

# Máquinas laminadoras de PASTA



**Regulador de grosor de pasta (3,4 mm - 0,93 mm)**  
Pasta thickness Regulator (3,4 mm - 0,93 mm)



## Máquina laminadora pasta

Machine Lamineuse à pâte  
Pastmaschine  
Pasta Machine Slicer  
Maquina de Pasta

	Ref	€	mm	U.Venta
A	60390	45,40	145	1
B	60391	83,80	260	1

## Disfruta cocinando tu propia pasta fresca

Enjoy cooking your own fresh pasta

- Rodillos de acero inoxidable, permiten conseguir hasta 9 grosores de pasta.
- Posibilidad del accesorio para Raviolis.

- Rouleaux en acier inoxydable, qui permettent d'obtenir jusqu'à 9 épaisseurs de pâtes.
- Possibilité d'ajouter l'accessoire pour raviolis.

- Edelstahlwalzen mit 9 verschiedenen Stärken für Ihre Nudeln.
- Mit Ravioli-Aufsatz erhältlich.

- Stainless steel rollers with 9 different thickness settings allowing you to make different varieties of pasta.
- Additional accessory for making ravioli.

- Rolos de aço inoxidável, para elaborar até 9 espessuras diferentes de massas.
- Possibilidade de utilização de acessório para elaborar raviolis.

## Amplía las recetas con el accesorio para ravioli

Expand recipes with ravioli accessory



## Accesorio para ravioli

Accessoire pour raviolis  
Zubehör für Ravioli  
Ravioli maker  
Acessório para ravióis

	Ref	€	Columnas	Ravioli	U.Venta
A	60497	21,80	2	45x45 mm	1
B	60498	21,80	3	30x30 mm	1

Solo puede utilizarse en la máquina de 145 mm (Ref: 60390)  
Only can be used in the machine of 145 mm (Ref: 60390)

Inox  
18/10

## Medidor de pasta Inox

Mesureur pour pâtes en Inox  
Spaghetti-Mass Rostfrei  
St steel pasta measurer  
Medidor para macarrao en Inóx

	Ref	€	cm	U.Venta
A	62942	3,30	18	1
B	62943	4,60	11x9	1



# EMBUTIDORA manual

**Incluye boquillas**  
Includes nozzles  
Ø38 mm Ø32 mm Ø22 mm Ø16 mm



**Contenedor inclinable 90°**  
90° tiltable container

**Cambio rápido de boquillas**  
Quick tube change

**Inox**  
18/10



## Embutidora manual

Poussoir manuel  
Manuelle Wurstfüller  
Manual stuffer  
Máquina para encher salsichas manual

Ref	€	L	Cilindro (cm)	U.Venta
60253	278,70	3	Ø14 x 20	1
60255	319,50	5	Ø14 x 32	1
60257	368,40	7	Ø14 x 46	1
60251	424,30	10	Ø22 x 27	1

**2 velocidades**  
2 speed

- Fabricada en acero inoxidable de gran calidad.
- Permite producir diferentes tipos de embutidos como chorizos, butifarras, salchichas, etc.
- Gran capacidad, ideal para carnicerías, restaurantes y cocinas industriales.
- Produce los embutidos de forma rápida y eficiente.
- Incluye 4 boquillas de llenado de Ø16, 22, 32 y 38 mm.
- Tuerca de unión de fácil manejo que permite cambiar rápidamente las boquillas de llenado.
- Cuenta con dos velocidades (lenta/rápida) gracias a un mecanismo de dos marchas accionado por rodamiento.
- El contenedor es inclinable a 90 grados para facilitar el llenado y limpieza.

- Fabriqué en acier inoxydable de grande qualité.
- Permet de produire différents types de saucisses comme les chorizos, les saucisses catalanes, les saucisses classiques, etc.
- Grande capacité, idéal pour les boucheries, les restaurants et les cuisines industrielles.
- Produit des saucisses de façon rapide et efficace.
- Inclut 4 tuyaux de remplissage de Ø16, 22, 32 et 38 mm.
- Vis d'assemblage facile à utiliser qui permet de changer rapidement les tuyaux de remplissage.
- Dispose de deux vitesses (lent/rapide) grâce à un mécanisme à deux vitesses actionné par roulement.
- Le conteneur est inclinable à 90 degrés pour faciliter le remplissage et le nettoyage.

- Made of high quality stainless steel.
- Can be used to make different kinds of sausages, like chorizo or butifarra.
- High capacity, perfect for butcher shops, restaurants and industrial kitchens.
- Make sausages quickly and efficiently.
- Includes four 16, 22, 32 and 38 mm diameter filling tubes.
- The easy to use bolt makes it easy to change the filling tubes quickly.
- It has 2 speeds (slow/fast) because of its two gear bearing driven mechanism.
- The container can be tilted 90° for easy filling and cleaning.

# CLIPADORA manual

**Capacidad de grapas: 200 unidades**  
Clip capacity: 200 units

**Regulación de presión**  
Pressure adjustment

**GRAPAS · STAPLES**  
Ref: 61201  
No incluidas · Not included



**Inox**

## Clipadora de alimentos

Clippeuse d'aliments  
Lebensmitteltacker  
Food clipping machine  
Agrafadora para alimentos

**Amplia base; estabilidad máxima**  
Wide base; maximum stability



- Fabricada en acero inoxidable de máxima calidad.
- Diseñada para grapar embutidos, mallas de fruta, bolsas, etc. con el mínimo esfuerzo.
- Accionamiento manual fácil y muy cómodo.
- Sistema de apoyo de zamak macizo que garantiza una estabilidad máxima.
- Capacidad de grapas: 200 unidades (ref: 61201 - no incluidas).
- Fácil de limpiar.

- Fabriqué en acier inoxydable de la plus grande qualité.
- Conçue pour agraffer de la charcuterie, des filets de fruits, des sachets, etc. avec un minimum d'efforts.
- Actionnement manuel facile et très pratique.
- Base en zamak massif qui garantit une stabilité maximale.
- Capacité d'agrafes : 200 unités (réf. : 61201 - non incluses).
- Facile à nettoyer.

- Aus Edelstahl bester Qualität hergestellt.
- Ideal zum mühelosen Tackern von Wurstwaren, Obstnetzen, Beuteln usw.
- Äußerst leichter und bequemer Handbetrieb.
- Stützvorrichtung aus massiver Zamak-Legierung garantiert maximale Standfestigkeit.
- Fassungsvermögen: 200 Klammern (Art.-Nr. 61201 – nicht inbegriffen).
- Leichte Reinigung.

- Made of top-quality stainless steel.
- Designed to staple sausages, fruit nets, bags, etc. with minimal effort.
- Easy, very comfortable manual operation.
- Solid zamak support system ensuring maximum stability.
- Staple capacity 200 units (ref: 61201 - not included).
- Easy to clean.

- Fabricada em aço inoxidável de grande qualidade.
- Para agrafar enchidos, malhas de fruta, sacos, etc., com o mínimo esforço.
- Acionamento manual, fácil e cómodo.
- Sistema de apoio de zamak maciço, que garante total estabilidade.
- Capacidade de agrafos: 200 unidades (ref: 61201 – não incluídos).
- Fácil de limpar.

Ref	€	cm	h (cm)	U.Venta
61200	299,50	37x15	58,5	1
61201	22,10	4,6 - 6	-	1

**Grapas (set de 4000 unidades)**  
Staples (set of 400)

# Centrifugadoras de VERDURAS



- Diseñadas para escurrir ensaladas y verduras.
- Gracias a su gran velocidad de centrifugado escurren la lechuga y las verduras en segundos.
- Fácil manejo gracias a su palanca EasySpeed (61400).
- Fácil manejo gracias al pomo giratorio ergonómico (61422 / 61404 / 61405).
- Versátiles: están compuestas por 3 piezas: tapa (61422: vertedor-escorridor integrado), rejilla y bol, perfecto para servir la ensalada en el mismo recipiente.
- Base antideslizante y 100% estable.
- Fácil limpieza: apto para el lavavajillas.
- 100% Libre de BPA.

- Conçue pour essorer des salades et des légumes.
- Grâce à sa grande force centrifuge, elle essore la salade et les légumes en quelques secondes.
- Facile à manipuler grâce à son levier EasySpeed (61400).
- Manipulation facile grâce au pommeau rotatif ergonomique (61422 / 61404 / 61405).
- Versatiles : composée de 3 pièces : couvercle avec bec verseur intégré, panier grillagé et saladier, parfait pour y servir la salade.
- Base antidérapante et 100% stable.
- Nettoyage facile : apte pour le lave-vaisselle.
- 100% sans BPA.

- Zum Schleudern von Salat und Gemüse
- Schleudert Salat und Gemüse schnell und effektiv.
- Leichtgängige EasySpeed Kurbel (61400).
- Am Drehgriff einfach zu bedienen (61422 / 61404 / 61405).
- Vielseitig einsetzbar: Aus 3 Teilen: (61422: Deckel zum Abgießen/ Abtropfen, Sieb und Behälter) Deckel, Sieb und Behälter (ideal zum Servieren von Salat).
- Rutschfester Boden, 100 % standfest.
- Einfach zu reinigen: spülmaschinengeeignet.
- 100% BPA-frei.

- Designed for removing excess water from salads and vegetables.
- Because of its high centrifuge speed it can strain salads and vegetables in seconds.
- Easy to use because of its EasySpeed lever (61400).
- Easy to handle because of the ergonomic rotating handle (61422 / 61404 / 61405).
- Versatile: they are made up of 3 pieces: lid (61422: integrated pourer-drainer), lid, grate, bowl, perfect for serving salad right from the container.
- Easy to clean. Dishwasher safe.
- 100% BPA free.

- Projetado para escorrer saladas e legumes.
- A sua grande velocidade de centrifugação permite escorrer perfeitamente a alface e as verduras em poucos segundos
- Fácil de utilizar graças à sua alavanca EasySpeed (61400).
- Fácil de utilizar, graças à pega giratória ergonómica (61422 / 61404 / 61405).
- Versátil: estão compostas com 3 elementos: tampa (61422: vertedor e escorridor integrado, grelha e taça. Ideal para servir a salada no mesmo recipiente.
- Base antideslizante, 100% estável
- Fácil de limpar. Apto para máquinas de lavar louça
- 100% sem BPA.

## 3 in 1

**Centrifugadora**  
Essoreuse  
Kreisel  
Spinner  
Centrifugadora

**Escorridor**  
Passoire  
Abtropfschüssel  
Colander  
Escorridor

**Ensaladera**  
Saladier  
Salatschüssel  
Salad bowl  
Saladeira

**Para uso profesional,  
sencillo y eficaz**  
For professional use,  
simple and efficient



**Fuerte construcción**  
Strong construction



**Tapa accionamiento de giro**  
Turn drive cover

**Cestillo escurridor**  
Basket wringer

**Bol**  
Bowl

**PP**

Polypropilene

## Centrifugadora profesional

Essoreuse à salade  
Salatschleuder  
Salad spinner drier  
Centrifugadora professional

Ref.	€	Ø (cm)	h (cm)	L	U.Venta
61420	202,40	32	33	12,0	1
61425	225,60	42	40	25,0	1

Article non vendu en France

**PP SAN**  
Polypropylene plastic

### Centrifugadora WHITE

Essoreuse  
Salatschleuder  
Spinner  
Centrifugadora

Ref	€	Ø (cm)	L	U.Venta
61403	29,60	26x20	5,00	1



**Botón de frenado**  
Button braking



**Sistema de palanca**  
Lever system



700  
r.p.m.



**Vertedor**  
Spout

**Inox 18/10 ASA**  
Acrylic

### Centrifugadora

Essoreuse  
Salatschleuder  
Spinner  
Centrifugadora

Ref	€	Ø (cm)	L	U.Venta
61404	79,00	24	4,00	1



**Incluye tapa. Ideal para servir y guardar alimentos**

Includes lid. Ideal for serving and storing food



**Inox**

### Centrifugadora INOX

Essoreuse  
Salatschleuder  
Spinner  
Centrifugadora

Ref	€	Ø (cm)	L	U.Venta
61405	98,70	24	4,50	1



**Tapa hermética**  
Hermetic lid



**Tapa centrifugadora**  
Spinner lid



**Escurreidor**  
Colander



**Bol antideslizante**  
Non-slip bowl

new



**Sistema de accionamiento**  
Drive system



**Sistema de frenado**  
Brake system



### Centrifugadora MINI

Essoreuse  
Salatschleuder  
Spinner  
Centrifugadora

Ref	€	cm	L	Ø Bol (cm)	Rejilla (cm)	U.Venta
61400	18,40	Ø19x16	1,8	Ø18,5x11,5	Ø18x10	1

new



**Vertedor**  
Spout



**Sistema de bloqueo**  
Lock system



### Centrifugadora KLEIN

Essoreuse  
Salatschleuder  
Spinner  
Centrifugadora

Ref	€	cm	L	Ø Bol (cm)	Rejilla (cm)	U.Venta
61422	19,10	Ø20,5x19	2,6	Ø18,5x13	Ø17x10	1

# Aguja de MECHAR

Inox  
18/10



Dishwasher



**Carnes y pescados más jugosos**  
Meats and fish juicier

**Puntiaguda y alargada**  
Pointed and elongated shape



**Doble superficie dentada para una perfecta sujeción**

Double-toothed surface for optimal grip

## Aguja de mechar

Aiguille à larder  
Spicknadel  
Stuffing needle  
Aguilha de mechar

Ref	€	L (cm)	U.Venta
61362	4,80	19	6

- Su forma puntiaguda y alargada, permite abrir orificios fácilmente en la carne o pescado e insertar tiras de beicon, verduras, frutas, quesos o especias.
- Sistema de amarre con doble superficie dentada para una perfecta sujeción.
- Consigue carnes más sabrosas y pescados más jugosos.
- Apta para lavavajillas.

- Sa forme pointue et allongée permet d'ouvrir facilement des orifices dans la viande ou le poisson et d'y insérer du bacon, des légumes, des fruits, du fromage ou des épices.
- Système d'adhérence avec double surface dentée pour une meilleure fixation.
- Obtenez des viandes plus savoureuses et des poissons plus juteux.
- Apte pour le lave-vaisselle.

- Seine spitze und längliche Form durchdringt Fleisch und Fisch problemlos zum Einziehen von Speck, Gemüse, Früchten, Käse oder Gewürzen.
- Doppelseitiges Befestigungssystem mit verzahnten Oberflächen für optimalen Halt.
- Holen Sie sich schmackhaftes Fleisch und saftiger Fisch.
- Spülmaschinengeeignet.

- Its pointed and elongated shape allows easy opening of holes in meat or fish and inserting strips of bacon, vegetables, fruits, cheeses or spices.
- Fastening system with double-toothed surface for optimal grip.
- Get tastier meats and juicier fish.
- Dishwasher safe.

- Sua forma pontiaguda e alongada permite abrir facilmente orificios em carnes ou peixes, e inserir tiras de bacon, verduras, frutas, queijos e especiarias.
- Sistema de fixação com superfície dentada dupla, para uma sujeição perfeita.
- Adquira carnes mais saborosas e peixes mais suculentos.
- Apta para máquina de lavar louça.

# JERINGA & PIPETAS para cocina

ASA

Acrylic



Dishwasher



BPA free



## Jeringa para cocina

Seringue pour cuisine  
Spritze Küche  
Kitchen syringe  
Seringa para cozinha

Ref	€	ml	Unidades	U.Venta
61418	6,00	30	ml-oz-tsp-Tbsp	6

- Inyecta salsas o especias.
- Extrae la salsa para reducirla en la sartén.

- Injecter des sauces ou des épices.
- Extraire du plat afin de les réduire dans une poêle à feu vif.

- Spritze zum Einspritzen von Saucen und Gewürzen.
- Extrahieren von Saucen um Sie in der Pfanne zu reduzieren.

- Syringe to inject sauces or spices.
- Extract them to separately reduce them in a frying pan.

- Injetar molhos ou especiarias.
- Extrair os molhos para reduzi-los numa frigideira a lume vivo.



Inox

## Pipeta para salsa

Poire à jus  
Sossenspritze  
Sauce syringe  
Pipeta para molho

Ref	€	L (cm)	ml	U.Venta
61408	17,60	30	40	1

## Pipeta para salsa

Poire à jus  
Sossenspritze  
Sauce syringe  
Pipeta para molho

Ref	€	L (cm)	ml	U.Venta
61416	12,90	30	40	1

# Botellas BIBERÓN



- Ideales para salsas, cremas, aceites, aliños, vinagretas y todo tipo de condimentos líquidos. Dibuja, adorna y personaliza con estilo tus platos.
- Idéal pour les sauces, les crèmes, les huiles, les assaisonnements, les vinaigrettes et tout type de condiments liquides. Il dessine, décore et personnalise les plats.
- Ideal für Soßen, Cremes, Öle, Dressings, Vinaigretten und alle möglichen flüssigen Gewürze. Verschönern und verzieren Sie Ihre Gerichte und geben Sie ihnen Ihren persönlichen Touch.
- Ideal for sauces, creams, oils, dressings, vinaigrettes and all kinds of liquid condiments. Draw, decorate and personalize your dishes with style.
- Ideais para molhos, cremes, óleos e azeites, temperos, vinagretas e todo o tipo de condimentos líquidos. Desenha, decora e personaliza com estilo.

Polyethylene (PE)

Polyethylene (PELD)  
Polyethylene Low Density



## Botella biberón c/boquilla triple

Bouteille biberon avec douille triple  
Dosierflasche mit Dreifachdüse  
Squeeze bottle with triple nozzle  
Garrafa com boquilha tripla

Ref	€	Ø (cm)	L	U.Venta
61974	4,00	7x20	0,47	6
61977	4,30	7x26	0,71	6

Polyethylene (PE)

Polyethylene (PELD)  
Polyethylene Low Density

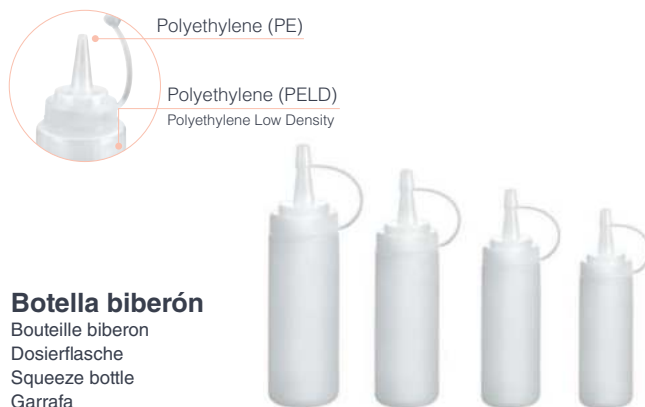

## Botella biberón

Bouteille biberon  
Dosierflasche  
Squeeze bottle  
Garrafa

Ref	€	Ø (cm)	L	U.Venta
61912	1,50	4x10	0,12	12
61925	1,60	5x19	0,25	12
61940	1,70	5,5x21,5	0,40	12
61970	1,90	7x26	0,70	12

Sist. de boca ancha que facilita el llenado  
Wide mouth system for easy filling

PE

Polyethylene

## Botella biberón PUSH

Bouteille biberon  
Dosierflasche  
Squeeze bottle  
Garrafa



Ref	€	Ø (cm)	L	U.Venta
61978	4,50	6x20	0,50	1
61979	4,60	7x20	0,60	1
61980	4,80	7x26	0,70	1

Ideal para ketchup  
Ideal for ketchup

## Botella biberón

Bouteille biberon  
Dosierflasche  
Squeeze bottle  
Garrafa



Ref	€	Ø (cm)	L	U.Venta
61925R	1,60	5x19	0,25	12
61940R	1,70	5,5x21,5	0,40	12
61970R	2,00	7x26	0,70	12

Ideal para mostaza  
Ideal for mustard

## Botella biberón

Bouteille biberon  
Dosierflasche  
Squeeze bottle  
Garrafa



Ref	€	Ø (cm)	L	U.Venta
61925A	1,60	5x19	0,25	12
61940A	1,70	5,5x21,5	0,40	12
61970A	2,00	7x26	0,70	12

SI

Silicone

## Biberón decoración

Biberon à decorer  
Dekorierflasche  
Decorating pen  
Garrafa decoração



Ref	€	Ø (cm)	L	U.Venta
64457	9,50	5,5x16	0,14	1



# Colección DOSIFICADORES

Inox  
18/10



Dishwasher

Salado · Salty



Dulce · Sweet



**Ideal para rellenar, verter y decorar**  
Perfect for filling, pouring and decorating

- Ideal para rellenar o decorar platos con salsas y cremas calientes y frías.
- Sistema de palanca para un caudal ajustable; práctico y preciso.
- Sistema antigoteo y antisalpicaduras.
- Mango con diseño ergonómico que permite el manejo con una sola mano.
- Fácil desmontaje para una sencilla limpieza. Apto para el lavavajillas.
- Ref.: 67150: Contiene 3 boquillas de distintos diámetros (4, 6 y 8 mm) para que las cremas y salsas fluyan de la forma deseada, en menor o mayor cantidad.

- Idéal pour remplir ou décorer des assiettes avec des sauces chaudes et froides.
- Système de piston pour un débit ajustable ; pratique et précis.
- Système anti-goutte et anti-éclaboussures.
- Manche ergonomique qui permet de le manipuler d'une seule main.
- Facile à démonter pour un nettoyage aisé, et apte pour le lave-vaisselle.
- Ref.: 67150: Contient 3 embouts de différents diamètres (4, 6 et 8 mm) pour que les crèmes et les sauces coulent de la façon souhaitée, en plus ou moins grande quantité.

- Er eignet sich ideal zum Anrichten oder Servieren von Saucen und Cremes, gleich ob kalt oder warm.
- Das Hebelsystem ermöglicht einen dosierten, bequemen und genauen Ausschank.
- Antitropf- und Antispritzsystem.
- Ergonomischer Griff für Einhandbedienung.
- Zum Reinigen einfach auseinandernehmbar und spülmaschinengeeignet.
- 3 Aufsätze im Durchmesser von 4, 6 und 8 Millimeter für einen Ausschank von Saucen und Cremes genau nach Bedarf.

- Perfect for filling or decorating dishes with hot or cold sauces and cream.
- Its lever system for controlling the flow is practical and precise.
- Anti-drip and anti-splash system.
- The ergonomic handle means it can be used with just one hand.
- It's easy to disassemble for easy cleaning and it's dishwasher safe.
- Ref.: 67150: Includes 3 nozzles with different diameters (4, 6 and 8 mm) so cream or sauce can flow just how you want, at a higher or lower quantity.

- Ideal para decorar platos e dispensar molhos e cremes, quentes ou frios.
- Caudal ajustável mediante sistema de alavanca, prático e preciso.
- Sistema anti-gotejamento e anti-salpicaduras.
- Mango com desenho ergonómico, que permite a manipulação com uma só mão.
- Fácil de desmontar para a sua limpeza. Apto para máquinas de lavar louça.
- Ref.: 67150: Inclui 3 boquilhas de diferentes diâmetros (4, 6 e 8 mm), que asseguram um fluxo adequado dos cremes e molhos, em menor ou maior quantidade.



Incluye soporte y un platillo antigoteo  
Includes support and a drip dish

## Dosificador

Entonnoir à decor  
Dosierer  
Portionner  
Dosificador

Ref	€	Ø (cm)	h (cm)	L	U.Venta
67150	61,60	19	27	2,0	1
R67150B	19,90	4/6/8			1

Set 3 boquillas  
Set 3 nozzles

Marcas de medición  
en el contenedor (ml - cup)  
Measuring marks  
on the container (ml - cup)

Ahorre tiempo frente a métodos tradicionales  
Save time compared to traditional methods



Si PS  
Silicone Polystyrene

## Dosificador

Entonnoir à decor  
Dosierer  
Portionner  
Dosificador

Ref	€	cm	h (cm)	L	U.Venta
67026	11,80	16x11	18	1,0	1

Sistema antigoteo y salpicaduras  
Anti drip and splash system



## Diseño premiado en certámenes internacionales

International award-winning flow  
 Good Design 2003 International Industrial  
 Graphic Design Competition The Chicago Athenaeum



Salado · Salty



Dulce · Sweet

**Sistema de gatillo para un caudal ajustable**  
 Trigger system for an adjustable flow



**Base con mucha estabilidad**  
 Base offers great stability

ASA

Acrylic



### Dosificador

Entonnoir à decor  
 Dosierer  
 Portionner  
 Dosificador

Ref.	€	L	U.Venta
67000	88,60	2,00	1

Inox  
 18/10

### Cono

Cône  
 Trichter  
 Cone  
 Cone

Ref.	€	L	U.Venta
R67000	39,30	2,00	1



### Soporte mango

Support  
 Stütze  
 Support  
 Suporte cabo

Ref.	€	U.Venta
R67001	35,40	1



### Base negra

Base noire  
 Ständer, schwarz  
 Black base  
 Base negra

Ref.	€	U.Venta
R67002	13,90	1



### Boquillas

Douille  
 Düse  
 Nozzle  
 Boquilhas

	Ref.	€	Ø (mm)	U.Venta
A	R67003	1,60	1	1
B	R67004	1,80	4	1
C	R67005	1,80	6	1
D	R67006	1,80	8	1

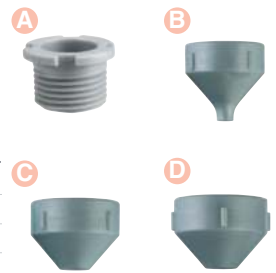

# SIFONES crema



**APTO SOLAMENTE PARA MEZCLAS FRIAS Y TEMPLADAS (<40°C)**  
**À UTILISER UNIQUEMENT POUR LES MÉLANGES FROIDS ET TREMPÉS (<40°C)**  
**ONLY SUITABLE FOR COLD AND TEMPERED MIXTURES (<40°C)**

- Realice en segundos purés, mousses, cremas montadas, espumas, salsas y deliciosos postres, un toque de elegancia en la cocina.
- Ofrece 4 veces más volúmen que el volúmen líquido.
- **NO** debe ser empleado con líquidos calientes. **NUNCA** ponga los sifones al baño maría, puede producirse una explosión con graves consecuencias.

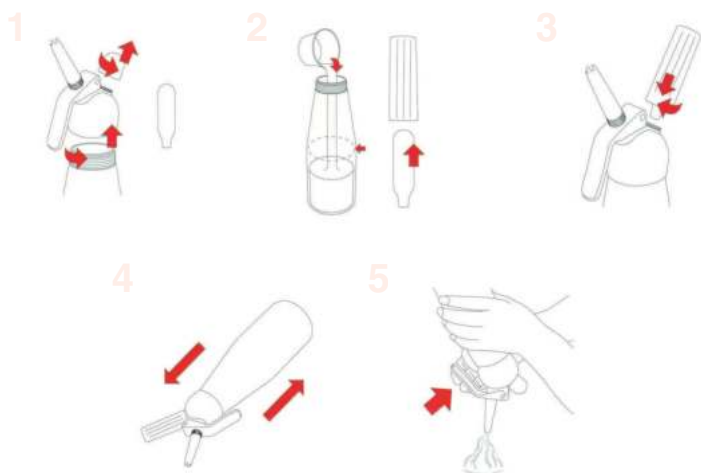

- Réalisez en quelques secondes des purées, des mousses, des crèmes montées, des sauces et de délicieux desserts, une touche d'élégance dans la cuisine.
- Confère 4 fois plus de volume que le volume liquide.
- **NE DOIT PAS** être utilisé avec des liquides chauds. **NE JAMAIS** mettre les siphons au bain marie car une explosion pourrait avoir lieu et provoquer de graves conséquences.
- Pürees, Mousses, Schlagsahne, Schäume, Saucen und köstliche Desserts im Nu zubereiten, ein Hauch von Eleganz in der Küche.
- Vervierfacht das Ausgangsvolumen der Flüssigkeit.
- **NICHT** für Verwendung mit heißen Flüssigkeiten geeignet. Gerät **NIEMALS** ins Wasserbad legen. Dies kann zu einer folgenschweren Explosion führen.

- Make purées, mousses, whipped creams, foams, sauces and delicious desserts in seconds. A touch of elegance in the kitchen.
- Whips content up to 4 times the liquid volume.
- Should **NOT** be used with hot liquids. **NEVER** put siphons in a water bath, as this may cause an explosion with serious consequences.

- Prepare em segundos purés, mousses, cremes batidos, espumas, molhos e deliciosas sobremesas, dando um toque de elegância à sua cozinha.
- Proporciona 4 vezes mais volume do que o volume líquido.
- **NÃO** utilizar com líquidos quentes. **NUNCA** coloque os sifões em banho-maria, para evitar o risco de explosão com consequências graves.



## Cargas sifón N2O

Cartouches N<sub>2</sub>O pour siphon  
 N<sub>2</sub>O Kapsel für Sahnebereiter  
 N<sub>2</sub>O cream charger  
 Botijas de sifão N<sub>2</sub>O



**EXCLUSIVAMENTE PARA USO ALIMENTICIO**  
**EXCLUSIVELY FOR FOOD USE**

Ref	€	Botellas	g	U.Venta
68402	8,30	10	8	1
68403	19,40	24	8	1

**Cabezal: aluminio**  
 Head: aluminium



**Botella: inox**  
 Bittle: inox

## Sifón MIX

Siphon à crème  
 Sahnebereite  
 Cream whipper  
 Sifão creme

Ref	€	Ø (cm)	L	U.Venta
68404	117,70	7,8x25	0,50	1
68405	135,20	9,3x32,5	1,00	1

**Temperatura de uso** · Use temperature  
 min = +5°C / max = +40°C

**Cabezal: plástico PBT**  
 Head: PBT plastic

**Botella: aluminio**  
 Bittle: aluminium

## Sifón WHITE

Siphon à creme  
 Sahnebereiter  
 Cream whipper  
 Sifão creme

Ref	€	Ø (cm)	L	U.Venta
68502	40,60	9x27	0,25	1
68500	48,10	9x31	0,50	1
68501	53,60	11x36	1,00	1

**Temperatura de uso** · Use temperature  
 min = +5°C / max = +40°C



**Cabezal: aluminio**  
 Head: aluminium

**Botella: aluminio**  
 Bittle: aluminium

## Sifón BLACK

Siphon à creme  
 Sahnebereiter  
 Cream whipper  
 Sifão creme

Ref	€	Ø (cm)	L	U.Venta
68604	50,70	7,8x27,3	0,50	1
68605	55,90	9,3x32,5	1,00	1

**Temperatura de uso** · Use temperature  
 min = +5°C / max = +40°C



# AHUMADORES de alimentos



69221 - 69321  
**Incluyen bolsa de serrín (100 g)**  
 Wood Chips bag included (100 g)  
**Olivo · Olive**

- Técnica popular de la cocina creativa; otorga a los platos aromas especiales y personalizados.
  - Perfecto para ahumar todo tipo de alimentos (carnes, pescados, quesos...).
  - La construcción y su diseño facilitan la limpieza y el mantenimiento.
  - Ideal para presentar y terminar platos delante del cliente.
  - Incluye un set de filtros de recambio.
  - Fácil de transportar gracias a su forma y tamaño .
  - Pilas no incluidas.
  - \* Compatible con nuestras campanas de ahumado (ref.: 61813, 61816, 61815, 61817) y la tapa (ref.: 69554).
- Technique populaire de la cuisine créative; qui confère aux plats des arômes spéciaux et personnalisés.
  - Parfait pour fumer tout type d'aliments (viandes, poissons, fromages...).
  - La fabrication et la conception de chacune de ses parties facilite son nettoyage et son entretien.
  - Idéal pour présenter et apporter la touche finale à des plats devant le client.
  - Inclut un set de filtres de recharge.
  - Facile à transporter grâce à sa forme et sa taille.
  - Piles non incluses.
  - \* Compatible avec nos cloches de fumage (réf.: 61813, 61815, 61816, 61817) et à couvercle (réf.: 69554).
- Beliebtes und kreatives Verfahren; das Speisen ein spezielles und individuelles Aroma verleiht.
  - Ideal geeignet, möglichen Lebensmittel (Fleisch, Fisch, Käse usw.) zu räuchern.
  - Die Teile sind so konstruiert und geformt, dass sie leicht gereinigt und gepflegt werden können.
  - Ideal dazu geeignet, Gerichte vor dem Gast anzurichten und zu präsentieren Inkl. Ersatzfiltern.
  - Handliche Form und Größe.
  - Batterien nicht im Lieferumfang enthalten.
  - \* Kompatibel mit unseren Räucherglocken (Art. Nr. : 61813, 61815, 61816, 61817) und der Deckel (Art. Nr. : 69554).
- A popular creative cooking technique which gives dishes special and personalised aromas.
  - Perfect for smoking all kinds of foods (meat, fish, cheeses...).
  - The way is designed and constructed makes it easy to clean and maintain.
  - Ideal for presenting and finishing dishes in front of the customer.
  - Includes a set of replacement filters.
  - Easy to transport thanks to its shape and size.
  - Batteries not included.
  - \* Compatible with our smoking cloches (ref.: 61813, 61815, 61816, 61817) and the lid (ref.: 69554).



Magic

A

- Técnica popular da cozinha criativa; proporciona aos pratos aromas especiais e personalizados.
- Perfeito para defumar todo o tipo de alimentos (carnes, peixes, queijos...).
- A construção e o design dos seus componentes facilitam a sua limpeza e manutenção.
- Ideal para apresentar e terminar pratos na presença do cliente.
- Inclui um conjunto de filtros de reposição.
- Fácil de transportar graças à sua forma e dimensões.
- Pilhas não incluídas.
- \* Compatível com as nossas campânulas para defumar (ref.: 61813, 61815, 61816, 61817) e la tampa (ref.: 69554).

Instant



B

## Ahumador de alimentos

Fumoir pour aliments  
 Apparat zum Räuchern von Lebensmitteln  
 Food smoker  
 Defumador de alimentos

	Ref	€	U.Venta
A	69221	47,70	1
B	69321	64,00	1

# CAMPANAS para ahumar de alimentos

Vidrio	Si	
Glass	Silicone	Dishwasher



- Campana que permite la entrada de humo, vapor y aromas para ahumar o aromatizar alimentos sin tener que levantarla.
- Fabricada en vidrio borosilicato de gran calidad y resistente a golpes, altas y bajas temperaturas.
- Se puede introducir en el microondas, horno y congelador.
- Válvula de inyección con autocierre de silicona (200°C).
- Complemento ideal para nuestros ahumadores.

- Cloche qui permet l'entrée de fumée, de vapeur et d'arômes pour fumer ou aromatiser les aliments sans avoir à la soulever.
- Fabriquée en verre borosilicate de grande qualité et résistante aux chocs ainsi qu'aux basses et hautes températures.
- Peut être mise au micro-ondes, au four ou au congélateur.
- Valve d'injection avec auto-fermeture en silicone (200°C).
- Complément idéal pour nos fumoirs.

- Die Glocke lässt Rauch, Dampf und Aromen eintreten, um darin befindliche Lebensmittel zu räuchern oder zu aromatisieren.
- Aus qualitativ hochwertigem Borosilikatglas, schlagfest und temperaturbeständig.
- Geeignet für Mikrowelle, Backofen oder Gefrierfach.
- Selbstschließende Injektionsklappe aus Silikon (200°C).
- Ideales Zubehör für unseren Räucherapparat.

- Cooker hood that lets smoke, steam and aromas inside for smoking or flavouring food without having to lift it up.
- Made of high quality impact resistant borosilicate glass that can withstand high and low temperatures.
- Microwave, oven and freezer safe.
- Injection valve with silicone self closure (200°C).
- A perfect addition for ours smokers.

- Campânula que permite a entrada de fumo, vapor e aromas para defumar ou aromatizar alimentos sem ter que levantar a tampa.
- Fabricada em vidro de borossilicato de grande qualidade, e resistente aos golpes, e a altas e baixas temperaturas.
- Pode introduzir-se no micro-ondas, no forno ou no congelador.
- Válvula de injeção com fecho automático de silicone (200 °C).
- Complemento ideal para o nossos defumadores.

## Campana ahumador

Cloche à fumer  
Räucherglocke  
Smoker Hood  
Campânula defumadora

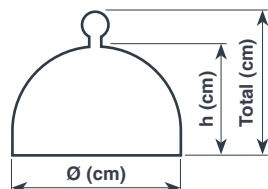

	Ref	€	Ø (cm)	h (cm)	Total (cm)	U.Venta
A	61813	13,80	12,5	7,5	11,0	1
B	61815	22,70	16,0	12,0	15,0	1
C	61816	25,10	20,0	12,0	15,0	1
D	61817	42,80	25,0	14,0	17,0	1

# MANGUERA para ahumador de alimentos

Goma

Rubber



- Permite ahumar dos platos a la vez, ahorrando tiempo.
- Incluye 2 mangueras de goma de 40 cm, 2 boquillas y un conector de conexión de mangueras.

- Il permet de fumer deux plats à la fois, économisant ainsi du temps.
- Il comprend deux tuyaux en caoutchouc de 40 cm, deux embouts et un raccord de tuyaux.

- Kann zwei Teller auf einmal räuchern und spart so Zeit.
- Zwei 40 cm Gummischläuche, zwei Mundstücke und ein Schlauchverbinder.

- Two dishes can be smoked at once to save time.
- Two 40 cm rubber hoses, two nozzles and a hose connector included.

- Permite defumar dois pratos simultaneamente, poupando tempo.
- Inclui duas mangueiras de borracha de 40 cm, duas boquilhas e um conector para as mangueiras.

## Manguera doble para ahumador

Double tuyau pour fumoir  
Doppelschlauch für Räucherapparat  
Double hoses for smoker  
Mangueira dupla para defumador

Ref	€	U.Venta
69521	8,80	1



Mangueras de goma flexible  
Flexible rubber hoses

# CAMPANAS para ahumar cócteles

<b>Vidrio</b>	<b>Si</b>	
Glass	Silicone	Dishwasher

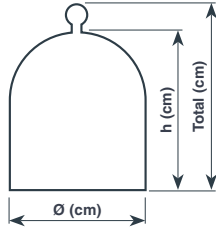

## Campana ahumador cóctel

Cloche à fumer pour cocktails  
Cocktail Räucherglocke  
Cocktail smoker  
Campânula defumadora para cocktails

	Ref	€	Ø (cm)	h (cm)	Total (cm)	U.Venta
A	61811	29,00	18,5	22,0	25,0	1
B	61812	34,50	12,5	26,5	30,0	1

- Fabricada en vidrio borosilicato de gran calidad, es resistente a golpes, altas y bajas temperaturas.
- Permite la entrada de humo, vapor y aromas para ahumar o aromatizar cócteles sin tener que levantar la tapa.
- Cuenta con una válvula de inyección con autocierre de silicona (max. 200° C).
- Apta para microondas, horno y congelador.
- Complemento ideal para los ahumadores de alimentos Magic (ref. 69221) e Instant (ref. 69321).

- Fabriquées en verre borosilicate de grande qualité, elles sont résistantes aux chocs ainsi qu'aux hautes et basses températures.
- Permettent l'entrée de fumée, de vapeur et d'arômes pour fumer ou aromatiser les cocktails sans avoir à soulever le couvercle.
- Dispositif d'une valve à injection avec fermeture automatique en silicone (max. 200°C).
- Aptes pour micro-ondes, four et congélateur.
- Complément idéal pour les fumeurs d'aliments Magic (réf. 69221) et Instant (réf. 69321).

- Aus qualitativ hochwertigem Borosilikatglas, schlagfest, hoch- und niedertemperaturbeständig.
- Lässt Rauch, Dampf und Aromen eintreten, um darin befindliche Cocktails zu räuchern oder zu aromatisieren.
- Mit selbstschließender Injektionsklappe aus Silikon (max. 200°C).
- Geeignet für Mikrowelle, Backofen und Gefriertruhe.
- Ideale Ergänzung für Lebensmittel-Räuchergeräte „Magic“ (Art.-Nr. 69221) und „Instant“ (Art.-Nr. 69321).

- Made of high quality borosilicate glass, the hood withstands shocks, high and low temperatures.
- Allows smoke, steam and aromas in, to smoke or flavour cocktails without having to lift the lid.
- It has a self-closing silicone injection valve (max. 200° C).
- Microwave, oven and freezer safe.
- Ideal complement for Magic (ref. 69221) and Instant (ref. 69321) food smokers.

- Fabricadas em vidro borossilicato de grande qualidade, resistente aos golpes e a altas e baixas temperaturas
- Permitem a entrada de fumo, vapor e aromas para defumar ou aromatizar cocktails sem ter que levantar a tampa
- Incluem uma válvula de injeção com autofecho de silicone (máx. 200° C)
- Aptas para micro-ondas, forno e congelador
- Complemento ideal para os defumadores de alimentos Magic (ref. 69221) e Instant ( ref. 69321).

# TAPA para ahumar cócteles

<b>ASA</b>	<b>Si</b>	
Acrylic	Silicone	Dishwasher



## Tapa para ahumar

Chapeau de fumée  
Rauchdeckel  
Smoke cap  
Tampa de fumaça

Ref	€	Ø (cm)	U.Venta
69554	4,20	12	1

- Tapa en forma de CD para crear un efecto hermético al momento de ahumar.
- Válido para todo tipo de envases, vasos, cocteleras, tarros, etc.
- Ideal para ahumar cócteles, destilados, comidas, quesos, etc.
- Válvula de inyección con autocierre de silicona (200°C).

- Couvercle en forme de CD pour créer un effet hermétique lors du fumage.
- Apte pour tout type de contenants, verres, shakers, pots, etc.
- Idéal pour fumer des cocktails, des alcools distillés, des plats, des fromages, etc.
- Valve à injection avec fermeture automatique en silicone (200°C).

- CD-förmiger Deckel zum luftdichten Verschluss beim Räuchern.
- Geeignet für Gefäße, Gläser, Mixbecher, Einmachgläser und alle Arten von Behältern.
- Ideal zum Räuchern von Cocktails, Destillaten, Speisen, Käse usw.
- Selbstschließende Injektionsklappe aus Silikon (200°C).

- Lid in the shape of a CD for creating a hermetic effect while smoking meats.
- Can be used with all kinds of container, glasses, cocktail glasses, jars, etc.
- Perfect for smoking cocktails, liquors, food, cheese, etc.
- Injection valve with silicone self seal (200°C).

- Tampa redonda com efeito hermético para defumar.
- Válido para todo o tipo de recipientes, como copos, shakers, frascos, etc.
- Ideal para defumar cocktails, destilados, comidas, queijos, etc.
- Válvula de injeção com fecho automático de silicone (200°C).

# SERRÍN para ahumador de alimentos

## Natural 100% Quality

A

Olive



100 g

Orange



100 g

Lemon



100 g

Almond



100 g

Whisky



100 g

Cognac



100 g

### La mejor elección para ahumar todo tipo de alimentos

The best choice to smoke all kinds of food

- OLIVO: aporta a los alimentos un sabor suave y aromático.
- NARANJO: aporta a los alimentos un sabor dulce, afrutado y el frescor de los cítricos.
- LIMONERO: aporta a los alimentos un toque cítrico y dulce muy suave.
- ALMENDRO: aporta a los alimentos un aroma suave, dulce y floral de la almendra.
- WHISKY: aporta a los alimentos un aroma de barril de roble empleado para el reposo del Whisky
- COGNAC: aporta a los alimentos un aroma de barril de roble empleado para el reposo del Cognac.
- Producen un humo denso y de alta calidad.
- Cumplen todas las normativas y reglamentaciones existentes para el empleo con alimentos.

- OLIVE: apporte aux aliments un goût doux, fruité et la fraîcheur des agrumes.
- ORANGE: apporte aux aliments un arôme délicat, doux et floral d'amande.
- CITRONNIER: apporte aux aliments une touche d'agrumes douce et très délicate.
- AMANDIER: apporte aux aliments un arôme délicat, doux et floral d'amande.
- WHISKY: apporte aux aliments un arôme de fut de chêne utilisée pour le vieillissement du whisky.
- COGNAC: apporte aux aliments un arôme de fut de chêne utilisée pour le vieillissement du cognac.
- Produit une fumée dense et de grande qualité.
- Respecte toutes les normes et réglementations existantes pour un usage alimentaire.

- OLIVE: provides food a smooth and aromatic flavour.
- ORANGE: provides food a sweet, fruity taste and citrusy freshness.
- LEMON: provides food a very soft sweet citrusy touch.
- ALMOND: provides food with a soft, sweet, floral aroma of almonds.
- WHISKY: aromatic sawdust from the oak barrel used for ageing the whiskey.
- COGNAC: aromatic sawdust from the oak barrel used for ageing the cognac.
- Produces dense, high-quality smoke.
- Meets all existing regulations and standards for use with food.

B

Olive



600 g

Orange



600 g

Lemon



600 g

Almond



600 g

Whisky



500 g

Cognac



500 g

### Serrín de madera

Scire de bois  
Räuchermehl  
Wood chips  
Serrín de madeira

	Ref	€	g	U.Venta	
	69550	7,20	100	1	Olivo · Olive
	69551	7,20	100	1	Naranja · Orange
	69552	7,20	100	1	Limonero · Lemon
A	69553	7,20	100	1	Almendro · Almond
	69559	7,20	100	1	Whisky
	69560	7,20	100	1	Cognac
	69555	9,80	600	1	Olivo · Olive
	69556	9,80	600	1	Naranja · Orange
	69557	9,80	600	1	Limonero · Lemon
B	69558	9,80	600	1	Almendro · Almond
	69567	9,30	500	1	Whisky
	69568	9,30	500	1	Cognac



# Básculas • Termómetros

Scales • Thermometers



# Básculas PROFESIONALES



**Cabezal orientable y abatible**  
Retractable, swivelling head

**Cuerpo aluminio fundido**  
Cast aluminium case

**Plataforma inoxidable 53x44cm**  
St. Steel platform, 53x44 cm

**Patas de apoyo regulables**  
Adjustable support feet



- Batería interna recargable (autonomía de 15 días).
- Visor de nivel, planitud.
- Avisador acústico de sobrecarga.
- Teclado intuitivo y de fácil uso. Funciones de calculadora.
- Acumulación de importes.
- Unidades de medida (Kg · oz · Libras). Función de tara.
- Libro de instrucciones en 7 idiomas.

- Batterie interne rechargeable (autonomie 15 jours).
- Indicateur de niveau, de planéité.
- Avertisseur acoustique de surcharge.
- Clavier intuitif d'utilisation facile. Fonctions de calculatrice.
- Accumulation de sommes
- Unités de mesure: (Kg · Oz · Livres). Fonction de tare
- Mode d'emploi en 7 langues

- Integrierte aufladbare Batterie (Leistungsdauer 15 Tage).
- Nivellierung-, Planheitsanzeige.
- Akustischer Warnton bei Überlastung.
- Berührungsempfindliche, einfach anzuwendende Tastatur. Rechenfunktionen
- Kumulierung mehrerer Beträge
- Gewichtseinheiten: (Kg · Oz · Pfund). Tara- funktion.
- Handbuch in 7 Sprachen.

- Rechargeable internal battery (last 15 days).
- Level and fatness indicator .
- Overload alarm.
- Intelligent and easy-to-use keyboard. Calculator funtions. Total counter.
- Measurement units: (Kg · Oz · pounds). Tare function
- Instructions book in 7 languages.

- Bateria interna recarregável (autonomia 15 dias).
- Vidor de nível, plintude.
- Avisador acústico de sobrecarga.
- Teclado intuitivo e de fácil uso. Função de calculadora.
- Cumulação de portes.
- Unidades de medida (Kg · Oz · pounds). Função de tara.
- Livro de instruções em 7 idiomas.

## Báscula electrónica con base cuadrada 150 kg (20 g)

Balance professionnel électronique 150 kgs. (20g)

Elektronische Küchenwaage mit rechteckigem Oberteil 150 kg (20g)

Electronic bench scale w/square base 150 kg (20g)

Balança electrónica com base quadrada 150 kg (20 g)

Ref	€	U.Venta
61700	1.146,70	1

Ref	Tensión/Voltage	Tara/Tare	Dimensiones/Sizes	Peso/Weight
61700	220-240 V / 50-60 Hz	150 Kgr (20 g)	49x75x90 cm	45 Kg

CERTIF.: 89/336/ECC, 91/263/EEC, 92/31/ECC, 93/68/EEC en 50 082 - 1:1992

**Doble display (Delante / Detrás)**  
Double display (Front / Back)

**Plataforma inoxidable 30x24cm**  
St. Steel platform, 30x24 cm

**Plataforma extraíble**  
Removable platform

**Patas de apoyo regulables**  
Adjustable support feet

**Teclado intuitivo y de fácil uso**  
Intelligent and easy-to-use keyboard



- Batería interna recargable (autonomía 15 días).
- Visor de nivel, planitud.
- Avisador acústico de sobrecarga.
- Funciones cambio.
- Seis memorias programables.
- Unidades de medida (Kgs., Oz., Libras). Función de tara.
- Libro de instrucciones en 7 idiomas.

- Batterie interne rechargeable (Autonomie 15 jours).
- Indicateur de niveau, de planéité.
- Avertisseur acoustique de surcharge.
- Fonctions changement.
- Six mémoire programmable.
- Unités de mesure: (Kgs., Oz, Livres). Fonction de tare.
- Mode d'emploi en 7 langues.

- Integrierte aufladbare Batterie (Leistungsdauer 15 Tage).
- Nivellierung-, Planheitsanzeige.
- Akustischer Warnton bei Überlastung.
- Tauschfunktionen.
- Sechs programmierbare Speicher.
- Gewichtseinheiten: (Kgrs., Oz, Pfund). Tara- funktion.
- Handbuch in 7 Sprachen.

- Rechargeable internal battery (Last 15 days).
- Level and fatness indicator.
- Overload alarm.
- Change funtions.
- Six programmable memories.
- Measurement units: (Kgrs, Oz, pounds). Tare function.
- Instructions book in 7 languages.

- Bateria interna recarregável (Autonomia 15 dias).
- Vidor de nível, plintude.
- Avisador acústico de sobrecarga.
- Função de mudança.
- Seis memória programável.
- Unidades de medida (Kgrs, Oz, pounds). Função de tara.
- Livro de instruções em 7 idiomas.

## Báscula electrónica con base cuadrada

Balance de cuisine électronique

Elektronische Küchenwaage mit rechteckigem Oberteil

Electronic scale w/square base

Balança electrónica com base quadrada

Ref	€	Tara
61716	472,20	15kg/5g
61730	508,10	30kg/10g

Ref	Tensión/Voltage	Potencia/Power	Tara/Tare	IP	Dimensiones/Sizes	Peso/Weight
61716	220-240 V / 50-60 Hz	0,2 W (max)	15 Kgr (5 g)	IPX 54	30x32x12 cm	4,60 Kg
61730	220-240 V / 50-60 Hz	0,2 W (max)	30 Kgr (10 g)	IPX 54	30x32x12 cm	4,60 Kg

CERTIF.: OIML R76 Clase III, 60/384/ECC

# Básculas ELÉCTRONICAS

Inox  
18/10



- Básculas perfectas para cualquier cocina.
- Función tara.
- Reseteo automático a cero.
- Pantalla LCD, fácil lectura de los resultados.
- Función de apagado automático para ahorrar energía.
- Indicador de batería baja y sobrecarga.

- Balances parfaites pour toutes les cuisines.
- Fonction tare.
- Mise à zéro automatique.
- Écran LCD, lecture facile des résultats.
- Fonction d'arrêt automatique pour permettre des économies d'énergie.
- Indicateur de batterie faible et de surcharge.

- Waages, ideais für jede Küche.
- Tarafunktion.
- Automatisches Zurücksetzen.
- LCD-screen, einfache Ablesung der Messwerte.
- Energiesparende automatische Abschaltung.
- Batteriestands- und Überlastanzeige.

- This scales is perfects for any kitchen.
- Tare function.
- Automatic reset to zero.
- LCD screen with easy to read results.
- Automatic shut-off to save energy.
- It has a low battery and overload indicator.

- Balanças perfeitas para qualquer cozinha.
- Função de tara.
- Posta a zero automática.
- Ecrã LCD, para uma leitura fácil dos resultados.
- Função de desconexão automática para poupar energia.
- Indicador de bateria baixa e de sobrecarga.

4 sensores de alta precisión  
Four high precision sensors



15 kg  
máx

## Báscula de cocina EBEN

Balance de cuisine  
Küchenwaage  
Kitchen scale  
Balança de cozinha

Ref	€	Kg	División (g)	cm	Unidades	U.Venta
61717	54,70	15	1	31x25,6x2,5	g/Kg/oz/lb:oz	1

Plataforma de pesaje en bambú  
Bamboo weighing platform



## Báscula BAMBOO

Balance  
Küchenwaage  
Scale  
Balança

Ref	€	Kg	División (g)	cm	Unidades	U.Venta
61712	23,80	5	1	21,8x18,8x2,1	g/ml/lb/oz/fl-oz	1

Plataforma de pesaje en cristal  
Glass weighing platform



## Báscula electrónica

Balance électronique  
Elektronische Küchenwaage  
Electronic scale  
Balança electrónica

Ref	€	Kg	División (g)	cm	Unidades	U.Venta
61708	27,30	5	1	27x18x4	g/oz/ml/cups	1

## Báscula de cocina electrónica

Balance de cuisine électronique  
Elektronische Küchenwaage  
Electronic kitchen scale  
Balança cozinha electrónica

Ref	€	Kg	División (g)	cm	U.Venta
61703	60,20	5	1	15,5x12	1



### Báscula sobremesa cristal

Balance électronique pour cuisine  
Elektronische Küchenwaage  
Electronic kitchen scale  
Balança sobremesa em vidro

Ref	€	Kg	División (g)	U.Venta
61725	22,60	5	1	1



### Báscula digital con bol extraíble

Balance numérique avec bol amovible  
Digitalwaage mit abnehmbarer Schale  
Scale digital with removable bowl  
Balança digital con bacia removível

Ref	€	Ø (cm)	L	Kg	División (g)	U.Venta
61707	36,90	21 (bol)	1,50	5	1	1



**Bol extraíble**  
Removable bowl



**Marcas de llenado**  
Filler marking



**Apertura y cierre deslizante**  
Opening and closing slide



**Teclado · Pantalla**  
Keyboard · Display

## Báscula ECO

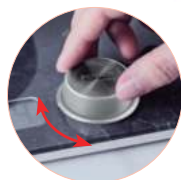

**Sistema EcoMove**  
EcoMove system

- Tecnología sin pilas ni baterías: se carga mediante el giro de la ruleta.
- Sistema EcoMove: convierte la energía cinética (energía en movimiento) en energía eléctrica.
- Fabricado en cristal templado de 4 mm de grosor y acabado con efecto mármol. Extraplano.
- Medición de alta precisión. Capacidad máxima de 5 kg con una división de 1 g.
- Pantalla LCD retroiluminada: facilita la lectura de los datos.
- Muestra los resultados en g (gramos), oz (onzas), lb:oz (onzas líquidas), ml-agua (mililitros- agua) y ml-leche (mililitros-leche).
- Apagado y reseteo automático.
- Función tara.
- Cuatro pies anti-deslizantes que proporcionan máxima estabilidad y seguridad.

- Technologie sans piles ni batteries : se recharge en faisant tourner la roulette.
- Système EcoMove : transforme l'énergie cinétique (énergie en mouvement) en énergie électrique.
- Fabriquée en verre trempé de 4 mm d'épaisseur et finition avec effet marbre. Conception extra-plate.
- Mesure de haute précision. Capacité maximale de 5 kg avec une précision de 1 g.
- Écran LCD rétroéclairé : facilite la lecture des données.
- Affiche les résultats en g (grammes), oz (onces), lb:oz (onces liquides), ml-eau (millilitres-eau) et ml-lait (millilitres-lait).
- Arrêt et remise à zéro automatiques.
- Fonction tare.
- Quatre pieds antidérapants qui confèrent une stabilité et une sécurité maximales.

- Battery Free Technology: Charged by turning the wheel.
- EcoMove System: converts kinetic energy (movement) into electric energy.
- Made of 4mm thick tempered glass with a marble effect finish.Extra-flat design.
- High precision measurement. Maximum capacity 5kg with 1g divisions.
- Backlit LCD Screen: makes reading information easy.
- Shows results in g (grams), oz (ounces), lb:oz (fluid ounces), ml-water (millilitres - water) and ml-milk (millilitres-milk).
- Automatic shutdown and reset.
- Tare function.
- The four non-slip feet provide maximum stability and safety.

### Báscula de cocina ECO MARMOL

Balance de cuisine  
Küchenwaage  
Kitchen scale  
Balança de cozinha

Ref	€	Kg	División (g)	cm	U.Venta
61720	34,50	5	1	19x23,5x3,5	1

# Básculas de BAÑO

Sistema EcoMove  
EcoMove System

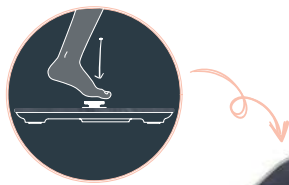

- Tecnología sin pilas ni baterías: se carga pulsando el botón central.
- Sistema EcoMove: convierte la energía cinética (energía en movimiento) en energía eléctrica.
- Fabricado en cristal templado de 5 mm de grosor y acabado con efecto mármol.
- Diseño extraplano.
- Medición de alta precisión: accionado por 4 sensores de peso de máxima precisión.
- Amplio rango de medición, desde los 8 kg hasta los 180 kg (máx.) con una división de 100 g.
- Pantalla LCD retroiluminada: facilita la lectura de los datos.
- Muestra los resultados en Kg (kilogramos) y lb (libras).
- Apagado y reseteo automático.
- Cuatro pies antideslizantes que proporcionan máxima estabilidad y seguridad.

- Technologie sans piles ni batteries : se recharge en appuyant sur le bouton central.
- Système EcoMove : transforme l'énergie cinétique (énergie en mouvement) en énergie électrique.
- Fabriquée en verre trempé de 5 mm d'épaisseur et finition avec effet marbre.
- Conception extra-plate.
- Mesure de haute précision : activation via 4 capteurs de poids d'une précision maximale.
- Grande amplitude de mesure : de 8 kg à 180 kg (max.) avec une précision de 100 g.
- Écran LCD rétroéclairé : facilite la lecture des données.
- Affiche les résultats en Kg (Kilogrammes) et lb (livres).
- Arrêt et remise à zéro automatiques.
- Quatre pieds antidérapants qui confèrent une stabilité et une sécurité maximales.

- Battery Free Technology: Charged by pushing the button in the middle.
- EcoMove System: converts kinetic energy (movement) into electric energy.
- Made of 5mm thick tempered glass with a marble effect finish.
- Extra-flat design
- High Precision Measurement: activated by 4 maximum precision weight sensors.
- Wide measurement range from 8kg up to 180kg (max) with 100g divisions.
- Backlit LCD Screen: makes reading information easy
- Shows results in Kg (kilograms) and lb (pounds)
- Automatic shutdown and reset
- The four non-slip feet provide maximum stability and safety.



## Báscula de baño ECO

Pèse personne  
Personenwaage  
Bathroom scale  
Escala de banheiro

Ref	€	Kg	División (g)	cm	U.Venta
61742	38,50	180	100	31x29x5	1



## Báscula de baño

Pèse personne  
Personenwaage  
Bathroom scale  
Escala de banheiro

Ref	€	Kg	División (Kg)	cm	Unidades	U.Venta
61740	33,10	180 (397lb)	0,1 (0,22lb)	31x31x4	Kg / lb	1

# Básculas de GANCHO



## Báscula con gancho

Balance électronique avec crochet  
Elektronische Küchenwaage mit Haken  
Electronic scale w/hook  
Balança de gancho

Ref	€	Kg	División (g)	U.Venta
61721	22,70	10	5	1



## Báscula con gancho PROFESIONAL

Balance électronique avec crochet  
Elektronische Küchenwaage mit Haken  
Electronic scale w/hook  
Balança de gancho

Ref	€	Kg	División (g)	cm	U.Venta
61722	72,60	0 - 50	20	32x10	1
		50 - 150	100		



# Básculas MECÁNICAS

Inox  
18/10

## Báscula RETRO WHITE

Balance  
Küchenwaage  
Scale  
Balança



Ref	€	Kg	División (g)	Ø Bol (cm)	U.Venta
61714	37,20	5	20	24 (2L)	1

## Báscula de cocina con bol

Balance de cuisine avec plateau creux  
Küchenwaage mit Schale  
Kitchen scale w/bowl  
Balança cozinha com bacia



Ref	€	Kg	División (g)	Ø Bol (cm)	U.Venta
61705	55,20	5	20	20,5x4	1
61710	56,90	10	50	20,5x4	1



## Báscula cocina WHITE

Balance de cuisine  
Küchenwaage  
Kitchen scale  
Balança cozinha



Ref	€	Kg	División (g)	U.Venta
61702	20,10	1	5	1

## Báscula de cocina con plato

Balance de cuisine avec plateau plat  
Küchenwaage mit flachem Oberteil  
Kitchenscale w/plain top  
Balança cozinha com prato



Ref	€	Kg	División (g)	U.Venta
61715	85,80	15	50	1

# Básculas de PRECISIÓN

Muestra los resultados  
en gramos (g) y onzas (oz)  
Shows the results  
in grams (g) and ounces (oz)



Inox



## Cuchara medidora digital

Cuillère avec Balance Digital  
Digitale Löffelwaage  
Digital spoon scale  
Colher de pesar Digital

Ref	€	g	División (g)	L (cm)	U.Venta
62519	39,50	300	0,10	28	1

Muestra los resultados en gramos (g), onzas (oz), onzas troy (ozt) y quilate (ct)  
Shows the results in grams (g), ounces (oz), troy ounces (ozt) and carat (ct).



## Báscula de precisión de bolsillo

Balance de précision de poche  
Taschen-Präzisionswaage  
Pocket precision scale  
Balança de precisão de bolso

Ref	€	g	División (g)	cm	U.Venta
61709	17,10	650	0,1	13x8x2	1

- Diseñadas para un pesaje muy preciso.
- Elabore recetas vanguardistas. La precisión de estas básculas ayudará a pesar los ingredientes más exclusivos.
- Compacta, ahorra espacio de almacenamiento.
- Plataforma de pesaje de acero inoxidable de máxima calidad (61709-61711).

- Designed for very precise weighing. Create nuanced recipes.
- The precision of this scale will help you weigh the most exclusive ingredients.
- Compact, to help save storage space.
- Weighing platform made of high quality stainless steel (61709-61711).



11x13x2 cm 10,5x10,5x0,5 cm

Incluye 2 bandejas para el pesaje (ABS plastic)

Includes 2 weighing trays

## Báscula de precisión BLACK

Balance de précision  
Präzisionswaage  
Precision scale  
Balança de precisão



Ref	€	Kg	División (g)	cm	U.Venta
61711	17,90	2	0,1	12,7x10,6x1,7	1

# Termómetros de **COCINA**

Inox



## Termómetro horno con base

Thermometre avec base pour four  
Backofen-Thermometer mit Ständer  
Oven thermometer with base  
Termómetro forno com base

Ref	€	Temp.	U.Venta
62454	9,70	50°C (122°F) 300°C (572°F)	1



## Termómetro refrigerador con base

Thermometre avec base pour réfrigérateur  
Külschrankthermometer mit Ständer  
Refrigerator thermometer with base  
Termómetro refrigerador com base

Ref	€	Temp.	U.Venta
62450	7,60	-30°C (-22°F) 30°C (86°F)	1



## Termómetro analógico de aceite

Thermometre analogique de huile  
Analog Thermometer für Öl  
Oil analogic thermometer  
Termómetro analógico óleo

Ref	€	cm	Temp.	U.Venta
62495	12,40	5x30,5	40°C (104°F) 200°C (392°F)	1

## Termómetro carne

Thermometre à cadran avec sonde pour viande  
Fleisch-Thermometer  
Meat thermometer  
Termómetro de carne

Ref	€	L (cm)	Temp.	U.Venta
62452	8,20	11	-54°C (-129°F) 88°C (190°F)	1



## Termómetro digital con alarma

Thermometre numérique avec alarme  
Digital Thermometer mit Alarm  
Digital thermometer with alarm  
Termómetro Digital con alarme

Ref	€	Ø (cm)	Temp.	U.Venta
62487	29,80	5x23	0°C (-32°F) 300°C (572°F)	1



## Termómetro electrónico carne

Thermometre électronique a/sonde pour viande  
Fleisch - Thermometer, Elektronisch  
Electronic meat thermometer  
Termómetro electrónico de carne

Ref	€	L (mm)	Temp.	U.Venta
62453	20,60	150	-40°C (-40°F) 150°C (302°F)	1

**La lente debería mantenerse limpia en todo momento**  
The lens should be kept clean at all times



## Termómetro electrónico

Thermometre Electronique  
Electric Thermometer  
Thermometer, Elektronisch  
Termómetro Electrónico

Ref	€	Temp.	U.Venta
62459	20,70	-40°C (-40°F) 150°C (302°F)	1



## Termómetro DUAL Infrarrojos - Sonda

Thermometre Dual Infrarouge - Sonde  
Dual-Thermometer Infrarot - Sonde  
Dual Thermometer Infrared - Probe  
Termómetro duplo infravermelhos - Sonda

Ref	€	Temp.	Sonda	U.Venta
62458	103,70	-40°C (-40°F) 230°C (302°F)	-33°C (-27°F) 220°C (428°F)	1



**Pantalla abatible**  
**Base magnética**  
Folding display  
Magnetic base



**Sonda de acero inoxidable**  
Stainless steel probe

**Doble pantalla para nevera y congelador**  
Double screen for fridge and freezer



**Base magnética**  
Magnetic base

### Termómetro digital horno con sonda

Thermomètre numérique pour le four avec sonde  
Digitaler Ofen-Thermometer mit Messfüler  
Oven digital Thermometer with probe  
Termómetro digital forno com sonda

Ref	€	cm	Temp.	U.Venta
62498	49,50	12x7,5	0°C (-32°F) 300°C (572°F)	1

### Termómetro alarma para nevera/congelador

Thermomètre alarme de réfrigérateur/congélateur  
Thermometer, m/Alarm f/Kühlschrank/Gefrierfach  
Fridge/Freezer alarm thermometer  
Termómetro alarma para refrigerador/congelador

Ref	€	Temp.	Temp.	U.Venta
62456	37,70	0°C (-32°F) 70°C (572°F)	0°C (-572°F) -40°C (-32°F)	1

**La lente debería mantenerse limpia en todo momento**  
The lens should be kept clean at all times

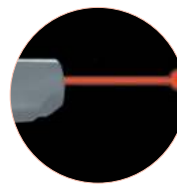

**NUNCA APUNTE CON EL DISPOSITIVO LOS OJOS DE ALGUIEN**  
He jamais pointer l'instrument vers les yeux de quelqu'un  
Das gerät niemals auf augen von personen richten  
Never point the device towards anyone's eyes  
Nunca aponte o aparelho aos olhos de alguém

**Incluye funda para su guardado y transporte**  
Includes cover for storage and transport

### Termómetro infrarrojos puntero laser

Therm. mesure de surface par infra rouge a/visée  
Laser et son étuil  
Infrarot Thermometer mit Lichtzeiger/Hülle  
Infrared thermometer w/laser pointer/pouch  
Termómetro infravermelhos ponta laser e interior

Ref	€	Temp.	U.Venta
62457	122,80	-50°C (-58°F) 400°C (752°F)	1

## Espátula · Cuchara termómetro con **SONDA**

SI	Inox	300°C	CE	BPA free
Silicone	Sonde	-50°C 572°F -64°F		

2 in 1

**Espátula. Funda de silicona extraíble**  
Spatula. Removable silicone sleeve

**Termómetro. Sonda de acero inoxidable**  
Thermometer. Stainless steel probe



2 in 1

**Cuchara. Funda de silicona extraíble**  
Spoon. Removable silicone sleeve

**Termómetro. Sonda de acero inoxidable**  
Thermometer. Stainless steel probe



### Espátula silicona con termómetro sonda

Spatule en silicone avec Thermometre sonde  
Teigschaber mit Thermometer/Sonde  
Silicone spatula with Thermometer probe  
Espátula silicone com Termómetro sonda

Ref	€	L (cm)	U.Venta
62500	16,00	25	1

### Cuchara silicona con termómetro sonda

Cuillère en silicone avec Thermometre sonde  
Löffel mit Thermometer/Sonde  
Silicone spoon with Thermometer probe  
Colher silicone com Termómetro sonda

Ref	€	L (cm)	U.Venta
62528	17,20	25	1

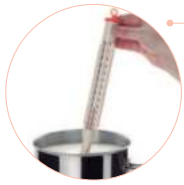

**Alcance la temperatura deseada**  
Reaches the desired temperature



**Ideal para medir las temperaturas de cocción (azúcar, caramelo, mermelada, etc...)**  
Ideal for measuring the temperatures of cooking (sugar, candy, jam, etc.)

**Funda de protección incluida**  
Protective cover included

**Protector de plástico**  
Plastic protector

**Escala de temperatura en grados Celsius**  
Celsius temperature scale

**Clip de sujeción (cacerolas) y bola de madera para un fácil manejo**  
Hanging clip (casserole) and wooden ball for easy handling

**Escalas de temperatura en grados Celsius y Fahrenheit**  
Celsius and Fahrenheit temperature scales

**PP**

Polypropylene

### Termómetro de leche

Thermomètre à lait  
Milch Thermometer  
Milk thermometer  
Termómetro de leite

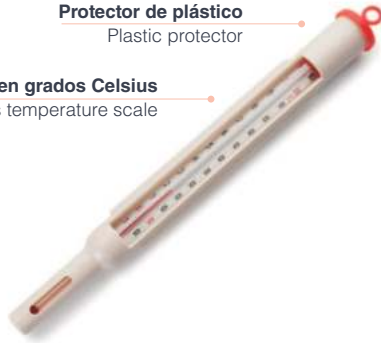

### Termómetro de azúcar

Thermomètre à sucre  
Zuckerthermometer  
Sugar thermometer  
Termómetro de açúcar

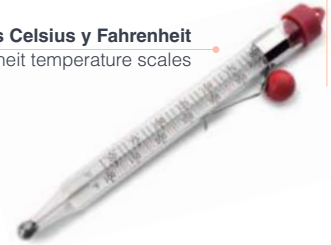

Ref	€	L (cm)	T°	Unidad	U.Venta
62532	11,80	26,5	-10°C/110°C	°C	1

Ref	€	L (cm)	T°	Unidades	U.Venta
62533	5,10	21,5	200°C (400°F)	°C / °F	12

## Relojes de COCINA



**Magnético**  
Magnet

### Reloj de cocina magnético

Minuteur de cuisine magnétique  
Magnetküchentimer  
Magnetic kitchen timer  
Relógio de cozinha magnético



- Gracias a su parte posterior magnética podrá colocar el reloj de cocina en cualquier parte metálica de su cocina.
- Alarma acústica programable.

- Grâce à sa partie arrière magnétique, le minuteur peut être placé sur n'importe quelle partie métallique de la cuisine.
- Alarme acoustique programmable.

- Dank der magnetischen Rückseite kann die Küchenuhr an jede metalische Oberfläche in Ihrer Küche angebracht werden.
- Programmierbarer akustischer alarm.

- Thanks to the magnet on the back, the kitchen timer can be placed on any metal surface in the kitchen.
- Programmable acoustics alarm.

- Graças à sua parte posterior magnética, poderá colocar o relógio de cozinha em qualquer parte metálica da sua cozinha.
- Alarme sonoro programável.

Ref	€	Tiempo	cm	U.Venta
60803	10,80	60 min	9,2x3,5	1

**Magnético**  
Magnet

### Reloj digital de cocina con avisador acústico

Minuter électronique  
Digitale Küchen-Zeitschaltuhr mit Alarm  
Digital kitchen timer w/alarm  
Relógio digital de cozinha com alarme acústico



Ref	€	cm	U.Venta
60805	9,00	10,5x7	1

**Magnético**  
Magnet

**Resistente al agua (IP65)**  
Water resistance



**24** 23h 59 min 59 seg

Horas/Hours

**12/24** 99:99:99

Horas/Hours

### Reloj de cocina con alarma

Minuteur de Cuisine avec Alarme  
Küchen-Zeitschaltuhr mit Alarm  
Kitchen Timer Alarm  
Relógio de cozinha com alarme

Ref	€	cm	U.Venta
60802	19,60	7x1,4x5,1	1

**Soporte plegable con potente imán**  
Folding stand with powerful magnet



### Reloj de cocina con alarma

Minuteur de Cuisine avec Alarme  
Küchen-Zeitschaltuhr mit Alarm  
Kitchen Timer Alarm  
Relógio de cozinha com alarme

Ref	€	cm	U.Venta
60804	38,90	13x24,5x2,5	1



---

# Mesa

---

Table top





**Bandejas · Fuentes**  
Trays

**Melamina**  
Melamine

**Servicio mesa**  
Table service

**Pinzas**  
Tongs

**Cafetería**  
Cafeteria

**Termos · Botellas**  
Thermos · Bottles

**Bar · Bodega**  
Bar · Wine cellar

**Porta menús**  
Menu cover

# Bandejas / Platos INOX



- Para uso profesional o doméstico.
- Fabricadas en acero inoxidable de alta calidad.
- Excelente resistencia a la corrosión.
- Ideales para servir o presentar todo tipo de comidas en buffets, restaurantes o en casa.

- Pour un usage professionnel ou domestique.
- Fabriqués en acier inoxydable de grande qualité.
- Excellente résistance à la corrosion.
- Parfaits pour servir ou présenter tout type d'aliments dans des buffets, des restaurants ou à la maison.

- Für Profis oder für Zuhause.
- Aus hochwertigem Edelstahl.
- Sehr korrosionsbeständig.
- Ideal zum Servieren oder Anrichten aller möglichen Speisen in Buffets, Restaurants oder Zuhause.

- For professional or home use.
- Made from high-quality stainless steel.
- Extremely resistant to corrosion.
- Ideal for serving and presenting all types of food in buffets, restaurants, or even at home.

- Para uso profissional ou doméstico.
- Fabricadas em aço inoxidável de alta qualidade.
- Excelente resistência à corrosão.
- Ideais para servir ou apresentar todo o tipo de comidas no lar, em buffets e em restaurantes.

## Fuente oval

Plat ovale  
Buffet-Tablett, oval  
Oval dish  
Travessa oval

Ref	€	cm	U.Venta
61820	5,90	20x13	1
61825	8,30	25x17	1
61830	9,10	30x20	1
61835	11,30	35x23	1
61840	13,60	40x26	1
61845	15,90	45x29	1
61850	19,50	50x31	1
61871	45,20	70x45	1
61881	52,80	80x48	1



Inox  
18/10

## Fuente oval pulido satinado

Plat ovale poli-satine  
Buffet-Tablett, oval  
Oval dish satin polish  
Travessa oval pulido mate

Ref	€	cm	U.Venta
62820	8,60	20x13	1
62825	10,90	25x17	1
62830	13,60	30x20	1
62835	16,80	35x23	1
62840	22,10	40x26	1
62845	25,00	45x29	1
62850	30,10	50x31	1



## Fuente de pescado

Plat à poisson  
Fischplatte  
Fish tray  
Travessa peixe

Ref	€	cm	U.Venta
61860	28,10	60x27	1
61880	35,60	80x30	1

## Fuente redonda

Plat rond  
Bratenplatte, rund  
Round serving dish  
Travessa redonda

Ref	€	Ø (cm)	U.Venta
61831	11,00	30	6
61836	13,70	35	6



## Fuente honda oval

Plat à gratin ovale  
Schale, oval  
Deep oval dish  
Travessa funda oval



Ref	€	cm	h (cm)	U.Venta
61828	13,70	30x20	4,5	1
61832	16,70	35x24	4,5	1
61838	20,60	40x26	4,5	1
61843	22,20	45x29	4,5	1
61848	26,50	50x31	4,7	1



## Bandeja de marisco

Plateau a fruit de mer.  
Platte für Seemuschel  
Sea food tray  
Bandeja de mariscos



Ref	€	Ø (cm)	U.Venta
14027	9,70	28	6
14042	21,60	42	1
14050	33,80	50	6

Inox  
18/10

## Bandeja camarero pulido satinado

Plateau limonadier poli-satine  
Servierblett, rund  
Serving tray satin polish  
Bandeja de servir pulido mate



Ref	€	Ø (cm)	U.Venta
62841	27,90	40	1

## Bandeja camarero

Plateau limonadier.  
Servierblett, rund  
Serving tray  
Bandeja de servir



Ref	€	Ø (cm)	U.Venta
61841	21,00	40	1



## Bandeja camarero

Plateau limonadier  
Servierblett  
Serving tray  
Bandeja de servir



Ref	€	Ø (cm)	U.Venta
14135	10,10	32	6
14136	11,70	36	1
14145	19,80	45	1

Inox  
18/10

## Bandeja octogonal

Plateau octogonal  
Platte, achteckig  
Octogonal tray  
Bandeja octogonal



Ref	€	cm	U.Venta
65031	54,70	31x24	1
65037	66,30	37x27	1
65041	116,20	41x32	1
65046	152,70	46x36	1

## Soporte para bandeja de mariscos

Support pour plateau a fruit de mer  
Ständer für Seemuschelplatte,  
Stand for sea food tray  
Soporte para bandeja de mariscos



Ref	€	Ø Sup. (cm)	Ø Inf. (cm)	h (cm)	U.Venta
14100	14,60	24,5	19	20	1

new

- Soporte fabricado en acero inoxidable de máxima calidad.
- Diseñado para apoyar bandejas de gran tamaño en servicio de sala.
- Barras tubulares y soportes cruzados para una mayor resistencia y estabilidad.
- 100% seguro: 8 arandelas ajustables y pies antideslizantes para que las bandejas no resbalen en ningún momento.
- Plegable; facilita el traslado y el almacenaje.

- Support fabriqué en acier inoxydable de la plus grande qualité.
- Conçu pour y poser des plateaux de grande taille lors du service en salle.
- Barres tubulaires et supports croisés pour une plus grande résistance et stabilité.
- 100% sûr : 8 rondelles réglables et pieds antidérapants pour que les plateaux ne glissent pas.
- Pliable ; facilite le transport et le rangement.

- Stand made of top-quality stainless steel.
- Specially designed to support large trays when serving food.
- Tubular bars and cross supports for extra strength and stability.
- 100% safe: 8 adjustable washers and non-slip feet to prevent the trays from slipping at any moment.
- Collapsible, easy to carry and store.

## Bandejas redondas, ovales, cuadradas, rectangulares, etc.

It can be used with round, oval, square, rectangular trays...

Plegable (7 cm)  
Collapsible (7 cm)



## Soporte para bandejas

Support pour plateaux  
Tabletthalter  
Tray stand  
Soporte para bandejas

Ref	€	cm	h (cm)	U.Venta
61870	68,00	41,5x52	80	1



Inox  
18/10

### Bandeja con pinza para notas

Porte addition à pince  
Platte mit Klemmvorrichtung  
Bill holder  
Bandeja com pinça para notas

	Ref	€	cm	U.Venta
A	68007	5,30	11x15,2	12
B	68017	6,20	12x21,5	12

PP ABS

Polypropylene Plastic Stackable



### Bandeja cambios COIN

Coupelle ramasse monnaie.  
Wechselgeldablagen  
Changetray  
Bandeja para trocos



Ref	€	Ø (cm)	U.Venta
68720	3,10	13	12

### Plato de huevos

Plat à oeufs  
Eiteller  
Egg serving dish  
Prato de ovos



Ref	€	Ø (cm)	h (cm)	U.Venta
61116	5,10	16	3	6

### Plato camping llano

Assiete plate de camping  
Camping Platzteller  
Camping dinner plate  
Prato camping raso



Ref	€	Ø (cm)	U.Venta
61121	7,00	22	1

### Plato camping hondo Inox

Assiete creuse de camping  
Camping Teller, tief  
Deep camping dinner plate.  
Prato camping fundo



Ref	€	Ø (cm)	U.Venta
61122	7,40	22	6

### Posabotellas

Dessous de bouteille  
Flaschenuntersetzer  
Bottle stand  
Pousa-garrafas



Ref	€	Ø (cm)	U.Venta
61113	3,80	13	6

### Posavasos

Sous-verre  
Glasuntersetzer  
Glass stand  
Pousa-copos



Ref	€	Ø (cm)	U.Venta
61110	3,20	10,5	6

# Bandejas PIZARRA



## Pizarra natural 100% · 100% natural slate

- Totalmente artesanales, cada bandeja es única e irreplicable.
- Ideal para la presentación de platos fríos y calientes.
- Ofrecen un aire de modernidad, elegancia y sencillez.
- Excelente conductor del frío y del calor.
- Evita los cambios bruscos de temperatura para su conservación.
- Contienen tacos antideslizantes para asegurar su estabilidad.
- **NOTA:** para conservarlas brillantes y con su color natural, cada ciertos usos impregnarlas con aceite de oliva virgen extra por ambas caras y cantos.

- Totalement artisanaux, chaque plateau étant unique et inimitable.
- Idéal pour la présentation de plats froids et chauds.
- Ils apportent un air de modernité, d'élégance et de simplicité.
- Excellent conducteur du froid et de la chaleur.
- Évite les changements de température brusques pour leur conservation.
- Possèdent des taquets antidérapants pour assurer leur stabilité.
- **REMARQUE :** pour conserver leur brillance et leur couleur naturelle, il faut les imprégner régulièrement d'huile d'olive vierge sur les deux côtés et sur les bords.

- Handgefertigte Einzelstücke aus Schiefer.
- Ideal zum Anrichten kalter und warmer Speisen.
- Modern, schlicht und elegant.
- Hervorragende Temperaturleitfähigkeit.
- Temperaturempfindlich, nicht schnell erhitzen oder abkühlen.
- Stabilisierende Antirutschunterlagen inbegriffen.
- **HINWEIS:** Nach längerem Gebrauch Politur aus Olivenöl zum Erhalt von Farbe und Glanz beidseitig und an den Rändern auftragen.

- Entirely handmade, every tray is unique and unreproducible.
- Perfect for presenting hot and cold dishes.
- They have an air of modernity, elegance and simplicity.
- Excellent conductor of heat and cold.
- Avoid abrupt temperature changes to prevent damage.
- They have anti-slip feet to ensure stability.
- **NOTE:** after every few uses, wipe the edges and both faces thoroughly with extra virgin olive oil to preserve their brightness and natural colour.

- Totalmente artesanais, sendo cada bandeja única e irrepelível.
- Ideal para a apresentação de pratos frios e quentes.
- Com um estilo moderno, simples e elegante.
- Excelente condutor do frio e do calor.
- Evita as mudanças bruscas de temperatura, conservando melhor a temperatura dos alimentos.
- Com tacos antideslizantes que asseguram uma boa estabilidade.
- **NOTA:** para as conservar brilhantes e com a sua cor natural, impregná-las periodicamente com azeite virgem extra em ambas as faces e dos lados.

### Bandeja redonda

Plateau rond  
Serviertablett rund  
Round tray  
Bandeja redonda



Ref	€	Ø (cm)	e (mm)	U.Venta
61070	3,50	20	5	6
61071	5,00	25	5	6
61072	6,90	30	5	6
61073	9,70	35	5	4

### Bandeja cuadrada

Plateau carré  
Serviertablett, vierecking  
Square tray  
Bandeja quadrada



Ref	€	cm	e (mm)	U.Venta
61010	3,00	10x10	5	32
61015	4,40	15x15	5	32
61019	5,10	20x20	5	24
61044	16,00	40x40	5	8



### Bandeja rectangular

Plateau rectangulare  
Serviertablett, rechteckig  
Rectangular tray  
Bandeja rectangular

Ref	€	cm	e (mm)	U.Venta
61016	4,20	10x15	5	48
61021	4,90	15x20	5	24
61029	6,10	15x30	5	18
61031	7,70	20x30	5	12
61041	9,00	20x40	5	12
61051	12,70	20x50	5	8
61043	14,00	40x30	5	8
61064	28,50	60x40	5	3

# Bandejas FIBREGLASS



- Para uso profesional.
- Fabricadas en fibra de vidrio.
- Superficie antiadherente y antideslizante.
- Indeforables y muy ligeras.

- Pour un usage professionnel.
- Fabriqué en fibre de verre.
- Surface antiadhésive et antidérapante.
- Indéformable et très légères.

- Für den professionellen Gebrauch.
- Aus Glasfaser.
- Antihaft- und rutschfeste Oberfläche.
- Unverformbar und Sehr leicht.

- For professional use.
- Made of fiberglass.
- Non-stick and non-slip surface.
- Undeformable and very light.

- Para uso profissional.
- Fabricado em fibra de vidro.
- Superfície antiaderente e antiderrapante.
- Indeforável e extremamente leve.



## Bandeja redonda

Plateau rond  
Serviertablett rund  
Round tray  
Bandeja redonda

Ref	€	Ø (cm)	U.Venta
69136	14,10	36	1
69140	20,90	40	1



## Bandeja rectangular

Plateau rectangulare  
Serviertablett, rechteckig  
Rectangular tray  
Bandeja rectangular

Ref	€	cm	U.Venta
69146	24,50	36x46	1
69152	29,50	38x52	1
69156	37,50	40x56	6
69165	53,90	45x65	6



## Bandeja oval

Plateau ovale  
Oval Serviertablett  
Oval tray  
Bandeja oval

Ref	€	cm	U.Venta
69168	64,20	56x68	6



# Melamina

Melamine



# Colección **EARTH**



- Fabricadas en melamina de alta calidad. Libre de BPA.
- Una completa gama que ofrece un aspecto rústico, con piezas únicas y elegantes.
- Diseñadas para realzar las creaciones del chef.
- Ligeras, resistentes a golpes y choques térmicos.
- Higiénicas y fácilmente lavables, aptas para lavavajillas.

- Produits fabriqués en mélamine de grande qualité. Sans BPA.
- Une gamme complète qui offre un aspect rustique, avec des pièces uniques et élégantes.
- Conçus pour réaliser les créations du chef.
- Légers, résistants aux chocs et aux variations thermiques.
- Hygiéniques et faciles à laver, aptes pour le lave-vaisselle.

- Aus hochwertigem Melamin. Ohne BPA.
- Eine komplette Palette einzigartiger, eleganter Artikel in rustikaler Optik.
- Bringt die Kreationen des Küchenchefs noch besser zur Geltung.
- Leicht, stoßfest. Widerstandsfähig gegen abrupte Temperaturwechsel.
- Hygienisch und leicht zu reinigen. Spülmaschinengeeignet.

- Made of high quality melamine. BPA free.
- A full range with unique and elegant pieces and a rustic look.
- Designed to highlight the chef's creations.
- Lightweight and resistant to impacts and thermal shock.
- Hygienic, easy to wash and dishwasher safe.

- Fabricadas em melamina de alta qualidade, sem BPA.
- Uma gama completa, de aspeto rústico, com peças únicas e elegantes.
- Desenhadas para realçar as criações do chef.
- Leves, resistentes aos golpes e aos choques térmicos.
- Higiénicas e fáceis de lavar, aptas para máquinas de lavar louça.

## Fuente rectangular

Plateau rectangulaire  
Serviertablet, rechteckig  
Rectangular tray  
Travessa rectangular



Ref	€	cm	h (cm)	U.Venta
63830	8,20	18,6x13,5	2,7	1

## Fuente rectangular

Plateau rectangulaire  
Serviertablet, rechteckig  
Rectangular tray  
Travessa rectangular



Ref	€	cm	h (cm)	U.Venta
63831	10,10	21,7x13,6	3,1	1
63832	12,40	25,2x17,2	3,6	1
63834	20,80	30,8x21,6	3,5	1
63855	28,50	35x23,8	4,1	1

## Fuente rectangular

Plateau rectangulaire  
Serviertablet, rechteckig  
Rectangular tray  
Travessa rectangular



Ref	€	cm	h (cm)	U.Venta
63833	11,40	28,6x12,7	3,4	1

## Fuente rectangular ondulada

Plateau rectangulaire ondulé  
Serviertablet, rechteckig, gewellt  
Rectangular undulated tray  
Travessa rectangular ondulada



Ref	€	cm	h (cm)	U.Venta
63865	18,40	29x17,5	3,0	1

## Fuente oval

Plateau oval  
Oval platte  
Oval tray  
Travessa redonda



Ref	€	cm	h (cm)	U.Venta
63863	9,50	25,4x13	2,9	1

## Fuente lágrima

Plateau larme  
Träne platte  
Tear tray  
Travessa lágrima



Ref	€	cm	h (cm)	U.Venta
63854	16,70	28,2x21,4	4,8	1

## Fuente oval

Plateau oval  
Oval platte  
Oval tray  
Travessa redonda



Ref	€	cm	h (cm)	U.Venta
63852	8,40	19,7x14,1	3,7	1
63853	11,50	22,5x16,4	4,4	1
63864	18,10	28,4x19	5,1	1

## Plato redondo

Plateau rond  
Rund Teller  
Round plate  
Prato redondo



Ref	€	Ø (cm)	h (cm)	U.Venta
63841	6,00	15,5	2,4	1
63842	9,00	19,4	2,9	1
63843	9,70	21,5	3,2	1
63844	15,30	24,2	3,5	1
63845	17,60	25,6	3,7	1

## Plato hondo redondo

Platteau profunde ronde  
Rund tiefe Platte  
Round deep plate  
Prato profundo redondo



Ref	€	Ø (cm)	h (cm)	U.Venta
63839	9,00	17,7	4,4	1
63840	18,90	24	5,5	1

## Bol redondo

Rond bol  
Boul rond  
Bowl round  
Bacia redonda



Ref	€	Ø (cm)	h (cm)	ml	U.Venta
63856	3,00	8,3	3,2	60	1
63857	4,80	9,5	4,6	130	1
63858	5,10	10,6	5,2	220	1
63859	7,00	12,6	6,0	300	1

## Bol

Bol  
Boul  
Bowl  
Bacia



Ref	€	Ø (cm)	h (cm)	ml	U.Venta
63861	6,40	12,4	4,6	300	1

## Bol cónico

Conique bol  
Boul Konish  
Conical bowl  
Bacia cónica



Ref	€	Ø (cm)	h (cm)	ml	U.Venta
63835	8,80	15,7	5,9	330	1
63836	10,70	18,3	6,8	560	1
63837	14,10	21,3	7,8	750	1
63838	19,90	24,2	8,8	1350	1

## Bol oval

Bol oval  
Oval boul  
Oval bowl  
Bacia oval



Ref	€	cm	h (cm)	ml	U.Venta
63849	4,50	12x10	4,1	130	1
63860	7,80	16,3x12,3	4,7	220	1
63850	15,60	20,7x16,8	8,0	660	1
63851	24,30	24,2x20,6	9,3	1150	1

## Fuente cuadrada

Plateau carrée  
Quadratischen platte  
Square tray  
Travessa quadrado



Ref	€	cm	h (cm)	ml	U.Venta
63846	7,50	12x12	5,0	200	1
63847	15,80	19x19	6,0	370	1
63848	24,50	24x24	6,8	840	1

## Bol salsa mini

Bol sauce mini  
Boul sauce mini  
Sauce bowl mini  
Bacia molho mini



Ref	€	cm	h (cm)	ml	U.Venta
63862	2,90	7,2x7,2	3,0	30	1

# Colección SEA



- Fabricadas en melamina de alta calidad. Libre de BPA.
- Una completa gama que ofrece un aspecto rústico, con piezas únicas y elegantes.
- Diseñadas para realzar las creaciones del chef.
- Ligeras, resistentes a golpes y choques térmicos.
- Higiénicas y fácilmente lavables, aptas para lavavajillas.

- Produits fabriqués en mélamine de grande qualité. Sans BPA.
- Une gamme complète qui offre un aspect rustique, avec des pièces uniques et élégantes.
- Conçus pour réaliser les créations du chef.
- Légers, résistants aux chocs et aux variations thermiques.
- Hygiéniques et faciles à laver, aptes pour le lave-vaisselle.

- Aus hochwertigem Melamin. Ohne BPA.
- Eine komplette Palette einzigartiger, eleganter Artikel in rustikaler Optik.
- Bringt die Kreationen des Küchenchefs noch besser zur Geltung.
- Leicht, stoßfest. Widerstandsfähig gegen abrupte Temperaturwechsel.
- Hygienisch und leicht zu reinigen. Spülmaschinengeeignet.

- Made of high quality melamine. BPA free.
- A full range with unique and elegant pieces and a rustic look.
- Designed to highlight the chef's creations.
- Lightweight and resistant to impacts and thermal shock.
- Hygienic, easy to wash and dishwasher safe.

- Fabricadas em melamina de alta qualidade, sem BPA.
- Uma gama completa, de aspeto rústico, com peças únicas e elegantes.
- Desenhadas para realçar as criações do chef.
- Leves, resistentes aos golpes e aos choques térmicos.
- Higiénicas e fáceis de lavar, aptas para máquinas de lavar louça.

## Fuente rectangular

Plateau rectangulaire  
Serviertablet, rechteckig  
Rectangular tray  
Travessa rectangular



Ref	€	cm	h (cm)	U.Venta
63941	8,20	18,6x13,5	2,7	1

## Fuente rectangular

Plateau rectangulaire  
Serviertablet, rechteckig  
Rectangular tray  
Travessa rectangular



Ref	€	cm	h (cm)	U.Venta
63942	10,10	21,7x13,6	3,1	1
63943	12,40	25,2x17,2	3,6	1
63945	20,80	30,8x21,6	3,5	1
63966	28,50	35x23,8	4,1	1

## Fuente rectangular

Plateau rectangulaire  
Serviertablet, rechteckig  
Rectangular tray  
Travessa rectangular



Ref	€	cm	h (cm)	U.Venta
63944	11,40	28,6x12,7	3,4	1

## Fuente rectangular ondulada

Plateau rectangulaire ondulé  
Serviertablet, rechteckig, gewellt  
Rectangular undulated tray  
Travessa rectangular ondulada



Ref	€	cm	h (cm)	U.Venta
63976	18,40	29x17,5	3,0	1

## Fuente oval

Plateau oval  
Oval platte  
Oval tray  
Travessa redonda



Ref	€	cm	h (cm)	U.Venta
63974	9,50	25,4x13	2,9	1

### Fuente lágrima

Plateau larme  
Träne platte  
Tear tray  
Travessa lágrima



Ref	€	cm	h (cm)	U.Venta
63965	16,70	28,2x21,4	4,8	1

### Fuente oval

Plateau oval  
Oval platte  
Oval tray  
Travessa redonda



Ref	€	cm	h (cm)	U.Venta
63963	8,40	19,7x14,1	3,7	1
63964	11,50	22,5x16,4	4,4	1
63975	18,10	28,4x19	5,1	1

### Plato redondo

Plateau rond  
Rund Teller  
Round plate  
Prato redondo



Ref	€	Ø (cm)	h (cm)	U.Venta
63952	6,00	15,5	2,4	1
63953	9,00	19,4	2,9	1
63954	9,70	21,5	3,2	1
63955	15,30	24,2	3,5	1
63956	17,60	25,6	3,7	1

### Plato hondo redondo

Platteau profonde ronde  
Rund tiefe Platte  
Round deep plate  
Prato profundo redondo



Ref	€	Ø (cm)	h (cm)	U.Venta
63950	9,00	17,7	4,4	1
63951	18,90	24	5,5	1

### Bol redondo

Rond bol  
Boul rund  
Bowl round  
Bacia redonda



Ref	€	Ø (cm)	h (cm)	ml	U.Venta
63967	3,00	8,3	3,2	60	1
63968	4,80	9,5	4,6	130	1
63969	5,10	10,6	5,2	220	1
63970	7,00	12,6	6,0	300	1

### Bol

Bol  
Boul  
Bowl  
Bacia



Ref	€	Ø (cm)	h (cm)	ml	U.Venta
63972	6,40	12,4	4,6	300	1

### Bol cónico

Conique bol  
Boul Konish  
Conical bowl  
Bacia cónica



Ref	€	Ø (cm)	h (cm)	ml	U.Venta
63946	8,80	15,7	5,9	330	1
63947	10,70	18,3	6,8	560	1
63948	14,10	21,3	7,8	750	1
63949	19,90	24,2	8,8	1350	1

### Bol oval

Bol oval  
Oval bowl  
Oval bowl  
Bacia oval



Ref	€	cm	h (cm)	ml	U.Venta
63960	4,50	12x10	4,1	130	1
63971	7,80	16,3x12,3	4,7	220	1
63961	15,60	20,7x16,8	8,0	660	1
63962	24,30	24,2x20,6	9,3	1150	1

### Fuente cuadrada

Plateau carrée  
Quadratischen platte  
Square tray  
Travessa quadrado



Ref	€	cm	h (cm)	ml	U.Venta
63957	7,50	12x12	5,0	200	1
63958	15,80	19x19	6,0	370	1
63959	24,50	24x24	6,8	840	1

### Bol salsa mini

Bol sauce mini  
Boul sauce mini  
Sauce bowl mini  
Bacia molho mini



Ref	€	cm	h (cm)	ml	U.Venta
63973	2,90	7,2x7,2	3,0	30	1

# Colección CLASSIC



- Una completa gama contemporánea en blanco y negro. Diseñadas para realzar las creaciones del chef.
- Une gamme complète contemporaine en noir et blanc. Conçues pour rehausser les créations du chef.
- Eine komplette Serie modernen Teilen in schwarz und weiß. Bringt die Kreationen des Küchenchefs noch besser zur Geltung.
- Wide collection contemporary black and white pieces. Designed to complete the chef's creations.
- Uma completa gama contemporânea em preto e branco. Pensadas para realçar as criações do chef.

## Bandeja rectang. WHITE

Plateau rectangulaire  
Serviertablet, rechteckig  
Rectangular tray  
Bandeja rectangular



Ref	€	cm	h (cm)	U.Venta
63531	8,60	26x16	2	6
63532	14,40	30x22	2	6

## Bandeja rectang. BLACK

Plateau rectangulaire  
Serviertablet, rechteckig  
Rectangular tray  
Bandeja rectangular



Ref	€	cm	h (cm)	U.Venta
63541	8,60	26x16	2	6
63542	14,40	30x22	2	6

## Bandeja rectang. WHITE

Plateau rectangulaire  
Serviertablet, rechteckig  
Rectangular tray  
Bandeja rectangular



Ref	€	cm	h (cm)	U.Venta
63533	18,60	30x21	3	6
63534	22,00	35x21	2	6

## Bandeja rectang. BLACK

Plateau rectangulaire  
Serviertablet, rechteckig  
Rectangular tray  
Bandeja rectangular



Ref	€	cm	h (cm)	U.Venta
63543	18,60	30x21	3	6
63544	22,70	35x21	2	6

## Bandeja rectang. WHITE

Plateau rectangulaire  
Serviertablet, rechteckig  
Rectangular tray  
Bandeja rectangular



Ref	€	cm	h (cm)	U.Venta
63535	37,30	53x32	3	6
63536	54,20	70x30	2	3

## Bandeja rectang. BLACK

Plateau rectangulaire  
Serviertablet, rechteckig  
Rectangular tray  
Bandeja rectangular



Ref	€	cm	h (cm)	U.Venta
63545	37,70	53x32	3	6
63546	54,20	70x30	2	3

## Fuente pescado WHITE

Plateau poisson  
Fischplatte  
Fish tray  
Travessa peixe



Ref	€	cm	h (cm)	U.Venta
63589	30,50	57x22	4	1

## Fuente pescado BLACK

Plateau poisson  
Fischplatte  
Fish tray  
Travessa peixe



Ref	€	cm	h (cm)	U.Venta
63599	30,50	57x22	4	1

### Fuente oval WHITE

Plateau oval  
Oval platte  
Oval tray  
Travessa redonda



Ref	€	cm	h (cm)	L	U.Venta
63557	9,70	32x12	6	0,85	6
63558	15,50	41,5x17	8	2,20	6

### Fuente oval BLACK

Plateau oval  
Oval platte  
Oval tray  
Travessa redonda



Ref	€	cm	h (cm)	L	U.Venta
63567	9,70	32x12	6	0,85	6
63568	15,50	41,5x17	8	2,20	1

### Bandeja delicatessen WHITE

Plateau delicatessen  
Schüssel delicatessen  
Delicatessen tray  
Bandeja delicatessen



Ref	€	cm	U.Venta
63609	3,50	9,5x9,5	6

### Bandeja delicatessen BLACK

Plateau delicatessen  
Schüssel delicatessen  
Delicatessen tray  
Bandeja delicatessen



Ref	€	cm	U.Venta
63619	3,50	9,5x9,5	6

### Bandeja delicatessen WHITE

Plateau delicatessen  
Schüssel delicatessen  
Delicatessen tray  
Bandeja delicatessen



Ref	€	cm	h (cm)	L	U.Venta
63610	3,00	10x10	2,5	0,12	6

### Bandeja delicatessen BLACK

Plateau delicatessen  
Schüssel delicatessen  
Delicatessen tray  
Bandeja delicatessen



Ref	€	cm	h (cm)	L	U.Venta
63617	3,00	10x10	2,5	0,12	6

### Fuente redonda WHITE

Plateau rond  
Rundplatte  
Round tray  
Travessa redonda



Ref	€	Ø (cm)	h (cm)	U.Venta
63551	28,90	40,0	6,0	6
63552	38,40	44,5	6,5	1

### Fuente cuadrada WHITE

Plateau rectangulaire  
Serviertablet, rechteckig  
Rectangular tray  
Travessa quadrada



Ref	€	cm	h (cm)	L	U.Venta
63573	28,20	33,5x33,5	8,5	5,0	1

### Fuente WHITE

Plateau  
Serviertablet  
Tray  
Travessa



Ref	€	Ø (cm)	h (cm)	L	U.Venta
63577	26,60	35,5	11	4,0	6

### Portatartas

Guéridon pâtisserie  
Kuchenplatte  
Cake stand  
Porta-tartes



Ref	€	Ø (cm)	h (cm)	U.Venta
63586	32,50	33	9	4

### Bol redondo WHITE

Bol rond  
Schale rund  
Round bowl  
Bacia redonda



Ref	€	Ø (cm)	h (cm)	L	U.Venta
63553	15,80	22	10,0	2,4	6
63554	23,40	28	10,0	4,0	6
63555	32,50	33	13,0	7,0	6
63556	40,40	38	14,5	11,0	2

### Bol oval WHITE

Bol oval  
Schale oval  
Oval bowl  
Bacia oval



Ref	€	cm	h (cm)	L	U.Venta
63585	23,70	29x26	16	4,0	6

### Bol ensalada WHITE

Bac salade  
Schüssel  
Salad bowl  
Bacia de salada



Ref	€	cm	h (cm)	L	U.Venta
63570	7,90	13x13	6	0,5	6
63571	19,80	19x19	9	2,0	1
63572	38,60	25x25	12	4,8	1

### Bol ensalada BLACK

Bac salade  
Schüssel  
Salad bowl  
Bacia de salada



Ref	€	cm	h (cm)	L	U.Venta
63580	7,90	13x13	6	0,5	6
63581	19,80	19x19	9	2,0	1
63582	38,60	25x25	12	4,8	1

### Ribbed bol

Ribbed bol  
Schale gerippt  
Bowl Ribbed  
Bacia Ribbed



Ref	€	Ø (cm)	h (cm)	L	U.Venta
63611	2,40	7,0	3	0,05	6
63612	2,80	8,5	4	0,10	6

### Bandeja oval

Plateau ovale  
Servierblech oval  
Oval tray  
Bandeja oval



Ref	€	cm	h (cm)	U.Venta
62751	4,20	20,7x14,4	1,8	10
62753	6,20	25,0x18,3	2,2	10
62754	6,80	28,0x20,0	2,4	10
62755	8,00	31,4x23,4	2,5	10
62756	10,10	33,5x25,8	2,6	10
62757	11,20	32,6x28,5	2,7	10
62759	16,50	45,8x34,8	3,0	10

### Bandeja redonda

Plateau rond  
Servierblech rund  
Round tray  
Bandeja redonda



Ref	€	Ø (cm)	h (cm)	U.Venta
62761	4,30	18,0	2,4	10
62762	5,10	20,0	2,5	10
62764	7,40	25,4	2,9	10
62766	12,20	30,7	3,3	10
62768	14,60	33,5	3,2	10
62769	21,00	40,0	3,5	6

### Plato redondo ondulado

Plateau rond ondulé  
Rund Teller gewellt  
Undulated round platte  
Prato redondo ondulado



Ref	€	Ø (cm)	h (cm)	U.Venta
62770	6,40	20,7	2,8	10
62771	10,70	25,0	3,0	1
62772	12,50	29,5	3,1	1

### Bandeja rectangular

Plateau rectangulaire  
Servierblech, rechteckig  
Rectangular tray  
Bandeja rectangular



Ref	€	cm	h (cm)	U.Venta
62791	7,30	24,8x16,0	2,3	10
62792	10,60	28,0x19,0	2,3	10
62793	12,20	30,0x20,8	2,3	10

## Bol cuadrado

Bac carre  
Schüssel, viereckig  
Square bowl  
Bacia quadrada



Ref	€	cm	h (cm)	L	U.Venta
62780	4,20	12,3x12,3	6,3	0,40	10
62781	4,90	14,9x14,9	7,0	0,70	10
62782	6,10	17,3x17,3	7,9	1,00	10
62783	8,00	19,7x19,7	8,8	1,50	1
62784	10,60	21,5x21,5	9,5	2,00	1

## Bol redondo

Bac rond  
Schüssel, rund  
Round bowl  
Bacia refondo



Ref	€	Ø (cm)	h (cm)	L	U.Venta
62785	3,70	11,8	5,1	0,30	10
62786	4,40	12,8	5,7	0,40	10
62787	5,20	14,9	6,5	0,60	10

## Cuchara lisa

Cuillère lisse  
ServierLöffel  
Plain spoon  
Colher lisa



Ref	€	L (cm)	U.Venta
63600	1,00	18	6

## Cacillo recto

Louche sauce  
Saucengiessl  
Soup ladle  
Concha molh



Ref	€	L (cm)	ml	U.Venta
63602	2,90	27	150	6

## Cacillo perforado

Louche perforee  
Saucengiesslöffel  
Slotted ladle  
Concha perforada



Ref	€	L (cm)	U.Venta
63605	2,90	27	6

## Cuchara recta

Louche plain  
Saucengiesslöffel  
Plainspoon  
Colher lisaa



Ref	€	L (cm)	ml	U.Venta
63601	1,80	25	40	6
63604	2,50	30	50	6

## Cuchara perforada

Louche perforee  
Saucengiessl  
Slotted spoon  
Colher perforada



Ref	€	L (cm)	U.Venta
63603	2,40	30	6



# Colección WHITE & BLACK



## Vaso

Timbale  
Trinkbecher  
Tumbler  
Copo



- Combina formas suaves y orgánicas con un diseño puro y elegante.
- Piezas en color blanco y negro, únicas y elegantes

- Allie des formes douces et organiques à un style pur et élégant.
- Pièces de couleur noire et blanche, uniques et élégantes.

- Soft and organic forms are combined with pure, stylish design.
- Unique and elegant white and black pieces.

	Ref	€	Ø (cm)	h (cm)	L	U.Venta	
A	63350	3,40	7,3	7,7	0,32	1	WHITE
B	63351	3,40	7,3	7,7	0,32	1	BLACK

## Bol cónico WHITE

Conique bol  
Schale konisch  
Conical bowl  
Bacia cónica



## Bol cónico BLACK

Conique bol  
Schale konisch  
Conical bowl  
Bacia cónica



	Ref	€	Ø (cm)	h (cm)	L	U.Venta
	63261	9,60	17	7,0	0,70	6
	63262	11,50	21	8,0	1,25	6
	63263	13,10	25	8,5	1,80	6

	Ref	€	Ø (cm)	h (cm)	L	U.Venta
	63361	9,60	17	7,0	0,70	6
	63362	11,50	21	8,0	1,25	6
	63363	13,10	25	8,5	1,80	6

## Bol redondo WHITE

Rond bol  
Schale rund  
Bowl round  
Bacia redonda



## Bol redondo BLACK

Rond bol  
Schale rund  
Bowl round  
Bacia redonda



	Ref	€	Ø (cm)	h (cm)	L	U.Venta
	63264	7,60	12,5	7,5	0,45	6
	63265	8,80	14,0	7,5	0,60	6

	Ref	€	Ø (cm)	h (cm)	L	U.Venta
	63364	7,60	12,5	7,5	0,45	6
	63365	8,80	14,0	7,5	0,60	6

## Bol oval WHITE

Bol oval  
Oval bowl  
Oval bowl  
Bacia oval



## Bol oval BLACK

Bol oval  
Oval bowl  
Oval bowl  
Bacia oval



	Ref	€	cm	h (cm)	L	U.Venta
	63268	7,80	17x14	6	0,40	6
	63269	17,50	24x20	9	1,70	6

	Ref	€	cm	h (cm)	L	U.Venta
	63368	7,80	17x14	6	0,40	6
	63369	17,50	24x20	9	1,70	6

## Fuente redonda WHITE

Plateau rond  
Rundplatte  
Round tray  
Travessa redonda



## Fuente redonda BLACK

Plateau rond  
Rundplatte  
Round tray  
Travessa redonda



	Ref	€	Ø (cm)	h (cm)	L	U.Venta
	63267	29,80	31	8	3,0	6

	Ref	€	Ø (cm)	h (cm)	L	U.Venta
	63367	29,80	31	8	3,0	6

### Fuente cuadrada WHITE

Plateau carrée  
Quadratischen platte  
Square tray  
Travessa quadrado



Ref	€	cm	h (cm)	U.Venta
63272	7,40	19x19	4	6
63273	15,90	25x25	5	6

### Fuente cuadrada BLACK

Plateau carrée  
Quadratischen platte  
Square tray  
Travessa quadrado



Ref	€	cm	h (cm)	U.Venta
63372	7,40	19x19	4	6
63373	15,90	25x25	5	6

### Fuente rectang. WHITE

Plateau rectangulaire  
Serviertablet, rechteckig  
Rectangular tray  
Travessa rectangular



Ref	€	cm	h (cm)	U.Venta
63274	9,60	25x17,5	3	6

### Fuente rectang. BLACK

Plateau rectangulaire  
Serviertablet, rechteckig  
Rectangular tray  
Travessa rectangular



Ref	€	cm	h (cm)	U.Venta
63374	9,60	25x17,5	3	6

### Fuente oval WHITE

Plateau ovale  
Schale oval  
Oval tray  
Travessa oval



Ref	€	cm	h (cm)	U.Venta
63275	13,30	32x14	4	6

### Fuente oval BLACK

Plateau ovale  
Schale oval  
Oval tray  
Travessa oval



Ref	€	cm	h (cm)	U.Venta
63375	13,30	32x14	4	6

### Fuente salsa mini WHITE

Plateau sauce mini  
Serviertablet sauce mini  
Sauce tray mini  
Travessa molho mini



Ref	€	cm	h (cm)	U.Venta
63279	4,00	9x7	3	6

### Fuente salsa mini BLACK

Plateau sauce mini  
Serviertablet sauce mini  
Sauce tray mini  
Travessa molho mini



Ref	€	cm	h (cm)	U.Venta
63379	4,00	9x7	3	6

### Fuente 3 salsas WHITE

Plateau 3 sauces  
Serviertablet 3 sauces  
3 sauces tray  
Travessa 3 molhos



Ref	€	cm	h (cm)	U.Venta
63280	5,50	19x8	3	6

### Fuente 3 salsas BLACK

Plateau 3 sauces  
Serviertablet 3 sauces  
3 sauces tray  
Travessa 3 molhos



Ref	€	cm	h (cm)	U.Venta
63380	5,50	19x8	3	6

### Bol salsa WHITE

Bac sauce  
Schüssel saucen  
Sauce bowl  
Bacia molho



Ref	€	cm	h (cm)	L	U.Venta
63270	5,90	14x12	5	0,25	6

### Bol salsa BLACK

Bac sauce  
Schüssel saucen  
Sauce bowl  
Bacia molho



Ref	€	cm	h (cm)	L	U.Venta
63370	5,90	14x12	5	0,25	6

# Colección FUJI



## Fuente cuadrada

Plateau rectangulaire  
Serviertablet, rechteckig  
Rectangular tray  
Travessa quadrada



Ref	€	cm	h (cm)	U.Venta
63161	15,60	22x22	2,5	6
63162	18,20	27,5x27,5	3,0	6

- Inspiradas en la cocina oriental.
- La armonía entre el Ying y el Yang constituyen el diseño exclusivo de la gama Fuji.

· Inspirées de la cuisine orientale.  
· L'harmonie du Ying et du Yang constitue le style exclusif de la gamme Fuji.

· Inspired by oriental cuisine.  
· The harmony between Ying and Yang forms the exclusive design of the Fuji range.

## Fuente lagrimea

Plat feuille  
Platte, Träne  
Tear plate  
Travessa lagrimea



Ref	€	cm	h (cm)	U.Venta
63175	15,10	34x13	3	6

## Bandeja rectangular

Plateau rectangulaire  
Serviertablet, rechteckig  
Rectangular tray  
Bandeja rectangular



Ref	€	cm	h (cm)	U.Venta
63163	14,50	29x18	3	6

## Bandeja rectangular

Plateau rectangulaire  
Serviertablet, rechteckig  
Rectangular tray  
Bandeja rectangular



Ref	€	cm	h (cm)	U.Venta
63164	21,50	34x21,5	2,5	6

## Bol

Bol  
Schale  
Bowl  
Bacia



Ref	€	Ø (cm)	h (cm)	L	U.Venta
63169	24,30	26	8	2,2	6

## Bandeja rectangular

Plateau rectangulaire  
Serviertablet, rechteckig  
Rectangular tray  
Bandeja rectangular



Ref	€	cm	h (cm)	U.Venta
63165	13,60	25x15	3	6

## Bol oval

Ovale bol  
Schale oval  
Oval tray  
Bacia oval



Ref	€	cm	h (cm)	L	U.Venta
63171	9,70	18x13,5	6	0,5	6
63172	15,60	24x17,5	6	1,0	6

## Fuente oval

Carrée ovale  
Schale oval  
Oval tray  
Travessa oval



Ref	€	cm	h (cm)	L	U.Venta
63166	14,70	25x19	5	0,6	6

## Bol oval

Ovale bol  
Schale oval  
Oval tray  
Bacia oval



Ref	€	cm	h (cm)	U.Venta
63173	6,80	14x8	4	6
63174	7,20	15x10	4	6

## Fuente hoja

Palt feuille  
Platte, Bratt  
Leaf plate  
Travessa folha



Ref	€	cm	h (cm)	U.Venta
63176	15,30	37,5x16	4,0	6
63177	22,40	46,5x21	6,5	6

## Cuchara snack

Cuillère snack  
Löffel snack  
Snack spoon  
Colher snack



Ref	€	cm	h (cm)	U.Venta
63178	4,40	14,5x14,5	4,5	6

# Colección **STONE**



- Fabricadas en melamina de alta calidad. Libre de BPA.
- Combinan formas naturales con aspecto elegante parecido al mármol.
- Diseñadas para realzar las creaciones del chef.
- Ligeras, resistentes a golpes y choques térmicos.
- Higiénicas y fácilmente lavables, aptas para lavavajillas.

- Produits fabriqués en mélamine de grande qualité. Sans BPA.
- Ils allient des formes naturelles à un aspect élégant semblable au marbre.
- Conçus pour réaliser les créations du chef.
- Légers, résistants aux chocs et aux variations thermiques.
- Hygiéniques et faciles à laver, aptes pour le lave-vaisselle.

- Made of high quality melamine. BPA free.
- They combine natural forms with an elegant appearance that looks like marble.
- Designed to highlight the chef's creations.
- Lightweight and resistant to impacts and thermal shock.
- Hygienic, easy to wash and dishwasher safe.

## Plato redondo

Plateau rond  
Rund Plate  
Round plate  
Prato redondo



Ref	€	Ø (cm)	h (cm)	U.Venta
63180	35,00	35	3,0	1
63181	53,40	44	3,0	1
63182	80,00	55	3,0	1

## Bandeja rectangular

Plateau rectangulaire  
Serviertablet, rechteckig  
Rectangular tray  
Bandeja rectangular



Ref	€	cm	h (cm)	U.Venta
63188	30,50	35x28,5	0,9	1
63189	38,60	43x28,5	0,9	1
63190	57,10	53x32	0,9	1

## Bandeja cuadrada

Plateau carrée  
Quadratischen platte  
Square tray  
Travessa quadrado



Ref	€	cm	h (cm)	U.Venta
63187	25,30	28,5x28,5	0,9	1

## Fuente oval

Carrée ovale  
Schale oval  
Oval tray  
Travessa oval



Ref	€	cm	h (cm)	U.Venta
63183	45,90	65x26	3,0	1

## Fuente huevo

Plat oeufs  
Eier platte  
Egg plate  
Travessa ovo



Ref	€	cm	h (cm)	U.Venta
63184	34,20	40,7x30,5	4,3	1

## Tabla con mango

Planche avec manche  
Servierbrett mit Griff  
Board with grip  
Tábua com mango



Ref	€	cm	h (cm)	U.Venta
63185	23,40	40x19,5	0,9	1
63186	32,10	46x25	0,9	1

## Fuente hoja

Palt feuille  
Bratt platte  
Leaf plate  
Travessa folha



Ref	€	cm	h (cm)	U.Venta
63191	21,40	40x25,3	4,3	1
63192	38,00	53x33	4,3	1

# Colección MAGMA



- Fabricadas en melamina de alta calidad.
- Libres de BPA.
- Ofrecen un aspecto muy natural parecido al hierro fundido.
- Ideales para servir y presentar los platos más exquisitos.

- Fabriqué en mélamine de haute qualité.
- Sans BPA.
- Aspect très naturel, semblable à la fonte d'aluminium.
- Idéale pour servir et présenter les plats les plus exquis.

- Hergestellt aus hochwertigem Melamin.
- Ohne BPA.
- Sehr natürliches Aussehen, ähnlich wie Gusseisen.
- Ideal zum Servieren und Anrichten erlesener Gerichte.

- Made of high quality melamine.
- BPA free.
- Very natural appearance similar to cast iron.
- Perfect for serving and presenting the most exquisite dishes.

- Fabricado em melamina de alta qualidade.
- Sem BPA.
- Aspecto natural similar ao ferro fundido.
- Ideales para servir e apresentar os pratos mais exquisitos.

## Cacerola redonda

Faitout rond  
Rund Bratentopf  
Round casserole  
Çaçarola redonda

Ref	€	Ø (cm)	U.Venta
63384	5,10	16	12
63385	6,20	18	12



## Cacerola oval

Faitout ovale  
Oval Bratentopf  
Oval casserole  
Çaçarola roval

Ref	€	cm	U.Venta
63388	4,50	18x12	12
63389	5,80	21x15	12



## Wok

Wok  
Wok  
Wok  
Wok

Ref	€	Ø (cm)	U.Venta
63386	4,30	15	12
63387	5,90	18	12



## Mini grill

Mini grill  
Mini grill  
Mini grill  
Mini grill

Ref	€	cm	U.Venta
63382	7,40	13,5x13,5	6



## Mini sartén

Mini pøele  
Mini Pfanne  
Mini frying pan  
Mini sertã

Ref	€	Ø (cm)	U.Venta
63381	7,00	15	6



## Mini sartén rectangular

Mini pøele rectangularare  
Mini Pfanne, rechteckiger  
Rectangular Mini frying pan  
Mini sertã rectangular

Ref	€	cm	U.Venta
63383	5,10	17x11,5	12



# Colección **MINI-COCOTTES**



- Fabricadas en melamina de alta calidad. Libres de BPA.
- Ofrecen un aspecto muy natural parecido al hierro fundido.
- Ideales para servir y presentar los platos más exquisitos.

- Made of high quality melamine. BPA free.
- Very natural appearance similar to cast iron.
- Perfect for serving and presenting the most exquisite dishes.

- Fabriqué en mélamine de haute qualité. Sans BPA.
- Aspect très naturel, semblable à la fonte d'aluminium.
- Idéale pour servir et présenter les plats les plus exquis.

- Fabricado em melamina de alta qualidade. Sem BPA.
- Aspecto natural similar ao ferro fundido.
- Ideales para servir e apresentar os pratos mais esquisitos.

- Hergestellt aus hochwertigem Melamin. Ohne BPA.
- Sehr natürliches Aussehen, ähnlich wie Gusseisen.
- Ideal zum Servieren und Anrichten erlesener Gerichte.

## Cacerola BLACK

Faitout  
Bratentopf  
Casserole  
Caçarola

	Ref	€	Ø (cm)	h (cm)	ml	U.Venta
<b>A</b>	63390	4,40	9	4,5	150	1
<b>B</b>	63391	11,80	18x8,5	5,0	480	1
<b>C</b>	63392	11,10	10	4,5	210	1
	63393	20,10	14	6,5	640	1



## Cacerola RED

Faitout  
Bratentopf  
Casserole  
Caçarola

	Ref	€	Ø (cm)	h (cm)	ml	U.Venta
<b>A</b>	63394	4,40	9	4,5	150	1
<b>B</b>	63395	11,80	18x8,5	5,0	480	1
<b>C</b>	63396	11,10	10	4,5	210	1
	63397	20,10	14	6,5	640	1



## Cacerola GREY

Faitout  
Bratentopf  
Casserole  
Caçarola

	Ref	€	Ø (cm)	h (cm)	ml	U.Venta
<b>A</b>	63398	4,40	9	4,5	150	1
<b>B</b>	63399	11,80	18x8,5	5,0	480	1
<b>C</b>	63400	11,10	10	4,5	210	1
	63401	20,10	14	6,5	640	1



# Cubetas GN **WHITE & BLACK**



- Fabricadas en melamina de alta calidad.
- Libres de BPA.
- Ligeras, indeformables y apilables.
- Higiénicas y fácilmente lavables.
- Aptas para procesos de refrigeración, congelación o distribución de alimentos.

- Fabriqué en mélamine de haute qualité.
- Sans BPA.
- Légères, indéformables et empilables.
- Hygiéniques et facilement lavables.
- Compatibles pour des processus de réfrigération, congélation ou distribution d'aliments.

- Hergestellt aus hochwertigem Melamin.
- Ohne BPA.
- Leicht, nicht verformbar und stapelbar. Hygienisch und einfach zu reinigen.
- Geeignet für Kühl-, Gefriervorgänge, Mikrowellenherde oder Nahrungsmittelverteilung.

- Made of high quality melamine.
- BPA free.
- Light, non-deformable and stackable.
- Hygienic and easily washable.
- Suitable for refrigeration and freezing processes and food distribution.

- Fabricado em melamina de alta qualidade.
- Sem BPA.
- Leves, indeformáveis e empilháveis.
- Higiénicas e facilmente laváveis.
- Aptas para processos de refrigeração, congelação ou distribuição de alimentos.

## Cubeta 1/1

Bac 1/1  
GN-Behälter 1/1  
Container 1/1  
Caixa 1/1



Ref	€	h (mm)	L	U.Venta
66165E	44,20	65	8,50	1
66110E	50,30	100	13,30	1

## Cubeta 1/1

Bac 1/1  
GN-Behälter 1/1  
Container 1/1  
Caixa 1/1



1/1  
530 x 325 mm

Ref	€	h (mm)	L	U.Venta
66165J	47,00	65	8,50	1
66110J	52,90	100	13,30	1

## Cubeta 1/2

Bac 1/2  
GN-Behälter 1/2  
Container 1/2  
Caixa 1/2



Ref	€	h (mm)	L	U.Venta
66265E	23,10	65	4,50	1
66210E	25,60	100	8,00	1

## Cubeta 1/2

Bac 1/2  
GN-Behälter 1/2  
Container 1/2  
Caixa 1/2



1/2  
265 x 325 mm

Ref	€	h (mm)	L	U.Venta
66265J	24,10	65	4,50	1
66210J	27,20	100	8,00	1

1/3  
176 x 325 mm

### Cubeta 1/3

Bac 1/3  
GN-Behälter 1/3  
Container 1/3  
Caixa 1/3



Ref	€	h (mm)	L	U.Venta
66365E	18,00	65	2,50	1
66310E	20,00	100	3,80	1

### Cubeta 1/3

Bac 1/3  
GN-Behälter 1/3  
Container 1/3  
Caixa 1/3



Ref	€	h (mm)	L	U.Venta
66365J	19,30	65	2,50	1
66310J	21,40	100	3,80	1

1/4  
265 x 162 mm

### Cubeta 1/4

Bac 1/4  
GN-Behälter 1/4  
Container 1/4  
Caixa 1/4



Ref	€	h (mm)	L	U.Venta
66465E	15,50	65	1,90	1
66410E	17,40	100	2,50	1

### Cubeta 1/4

Bac 1/4  
GN-Behälter 1/4  
Container 1/4  
Caixa 1/4



Ref	€	h (mm)	L	U.Venta
66465J	16,50	65	1,90	1
66410J	18,60	100	2,50	1

2/3  
350 x 325 mm

### Cubeta 2/3

Bac 2/3  
GN-Behälter 2/3  
Container 2/3  
Caixa 2/3



Ref	€	h (mm)	L	U.Venta
66565E	33,30	65	5,50	1

### Cubeta 2/3

Bac 2/3  
GN-Behälter 2/3  
Container 2/3  
Caixa 2/3



Ref	€	h (mm)	L	U.Venta
66565J	34,80	65	5,50	1

1/6  
176 x 162 mm

### Cubeta 1/6

Bac 1/6  
GN-Behälter 1/6  
Container 1/6  
Caixa 1/6



Ref	€	h (mm)	L	U.Venta
66665E	11,10	65	1,10	1
66610E	12,40	100	1,60	1

### Cubeta 1/6

Bac 1/6  
GN-Behälter 1/6  
Container 1/6  
Caixa 1/6



Ref	€	h (mm)	L	U.Venta
66665J	11,80	65	1,10	1
66610J	13,30	100	1,60	1

2/4  
530 x 165 mm

### Cubeta 2/4

Bac 2/4  
GN-Behälter 2/4  
Container 2/4  
Caixa 2/4



Ref	€	h (mm)	L	U.Venta
66765E	23,20	65	4,50	1

### Cubeta 2/4

Bac 2/4  
GN-Behälter 2/4  
Container 2/4  
Caixa 2/4



Ref	€	h (mm)	L	U.Venta
66765J	24,00	65	4,50	1



# Servicio mesa

Table service



# Manteles de mesa **CUERO**

Cuero  
Leather



OEKO-TEX®  
CONFIDENCE IN LEATHER  
**LEATHER STANDARD**

**Se pueden personalizar en seco**  
Can be customized in dry



- Fabricados en cuero 100% reciclado. Espesor de 1,5 y 2,1 mm.
- Disponibles en tres formatos; cuadrado, redondo y forma oval.
- Resistentes a altas temperaturas y manchas. Aislantes del calor. Impermeables.
- Se limpian fácilmente con solución hidroalcohólica sin dañar el producto.
- Perfectos para vestir y proteger las mesas de restaurantes, cafeterías y hasta el propio hogar.

- Fabriqué en cuir 100% recyclé. Épaisseur de 1,5 et 2,1 mm.
- Disponibles en trois formats : carrés, ronds et forme ovale.
- Résistants aux hautes températures et aux taches. Isolants de la chaleur. Imperméables.
- Se nettoient facilement avec un chiffon humide, du désinfectant, etc.
- Parfaits pour habiller et protéger les tables des restaurants, des cafétérias, et même pour un usage domestique.

- Aus 100 % Recycling-Leder. 1,5–2,1 mm dick.
- Erhältlich in drei Formaten: Viereck, Kreis und oval.
- Beständig gegen hohe Temperaturen und Flecken. Wärmedämmend. Wasserdicht.
- Einfache Reinigung mit feuchtem Lappen, Desinfizierer usw.
- Ideal als Tischbedeckung und -schutz für Restaurants, Cafeterias und auch für Zuhause.

- Made of 100% recycled leather. 1.5 mm and 2.1 mm Thickness.
- Available in three formats: square, round and oval shaped.
- Resistant to high temperatures and stains. Heat insulating. Waterproof.
- Easy to clean with a damp cloth, disinfectant, etc.
- Perfect for decorating and protecting tables in restaurants, cafés and even at home.

- Fabricadas em couro 100% reciclado. Espessura de 1,5 e 2,1 mm.
- Disponíveis em três formatos; quadrado, redondo e forma oval.
- Resistentes às altas temperaturas e às manchas. Isolantes do calor. Impermeáveis.
- Limpam-se facilmente com um pano húmido, desinfetante, etc.
- Perfeitos para cobrir e proteger as mesas de restaurantes, cafetarias e para uso doméstico.



## Mantel individual rectangular

Nappe individual rectangulaire  
Tischset, rechteckiger  
Rectangular individual placemat  
Toalhas de mesa individual rectangular

	Ref	€	cm	e (mm)	Color	U.Venta
<b>A</b>	66831	20,00	45x30	1,5	Marrón · Brown	1 MILOS
<b>B</b>	66832	20,00	45x30	1,5	Antracita · Anthracite	1 CRETA
<b>C</b>	66833	20,70	45x30	2,1	Marrón granulado · Grained brown	1 RINIA
<b>D</b>	66834	20,70	45x30	2,1	Negro granulado · Grained Black	1 COS

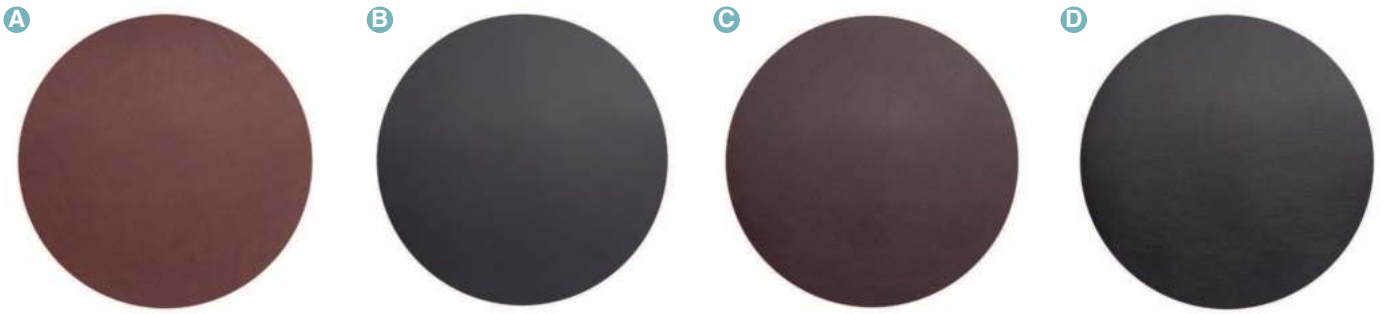

### Mantel individual redondo

Nappe individual rond  
Tischset, rund  
Round individual placemat  
Toalhas de mesa individual redondo

	Ref	€	Ø (cm)	e (mm)	Color	U.Venta
A	66835	23,60	40	1,5	Marrón · Brown	1 MILOS
B	66836	23,60	40	1,5	Antracita · Anthracite	1 CRETA
C	66837	24,80	40	2,1	Marrón granulado · Grained brown	1 RINIA
D	66838	24,80	40	2,1	Negro granulado · Grained Black	1 COS



### Mantel individual oval

Nappe individual ovale  
Tischset, oval  
Oval individual placemat  
Toalhas de mesa individual oval

	Ref	€	cm	e (mm)	Color	U.Venta
A	66839	21,60	45x35	1,5	Marrón · Brown	1 MILOS
B	66840	21,60	45x35	1,5	Antracita · Anthracite	1 CRETA
C	66841	22,70	45x35	2,1	Marrón granulado · Grained brown	1 RINIA
D	66842	22,70	45x35	2,1	Negro granulado · Grained Black	1 COS



### Fabricados en 75% PVC + 25% Polyester

Fait de 75% PVC + 25% Polyester  
 Hergestellt aus 75% PVC + 25% Polyester  
 Made of 75% PVC + 25% Polyester  
 Feita de 75% PVC + 25% Polyester



### Mantel individual

Nappe individuel  
 Tischset  
 Individual placemat  
 Toalha de mesa individual

	Ref	€	cm	U.Venta	
A	66772	4,80	45x30	6	LANTA
B	66773	4,80	45x30	6	KOTAO
C	66780	4,70	45x30	6	SUMBA
D	66781	4,70	45x30	6	BIAK
E	66782	4,70	45x30	6	GILI
F	66783	4,70	45x30	6	RINCA

### Fabricados en 75% PVC + 25% Polyester

Fait de 75% PVC + 25% Polyester  
 Hergestellt aus 75% PVC + 25% Polyester  
 Made of 75% PVC + 25% Polyester  
 Feita de 75% PVC + 25% Polyester

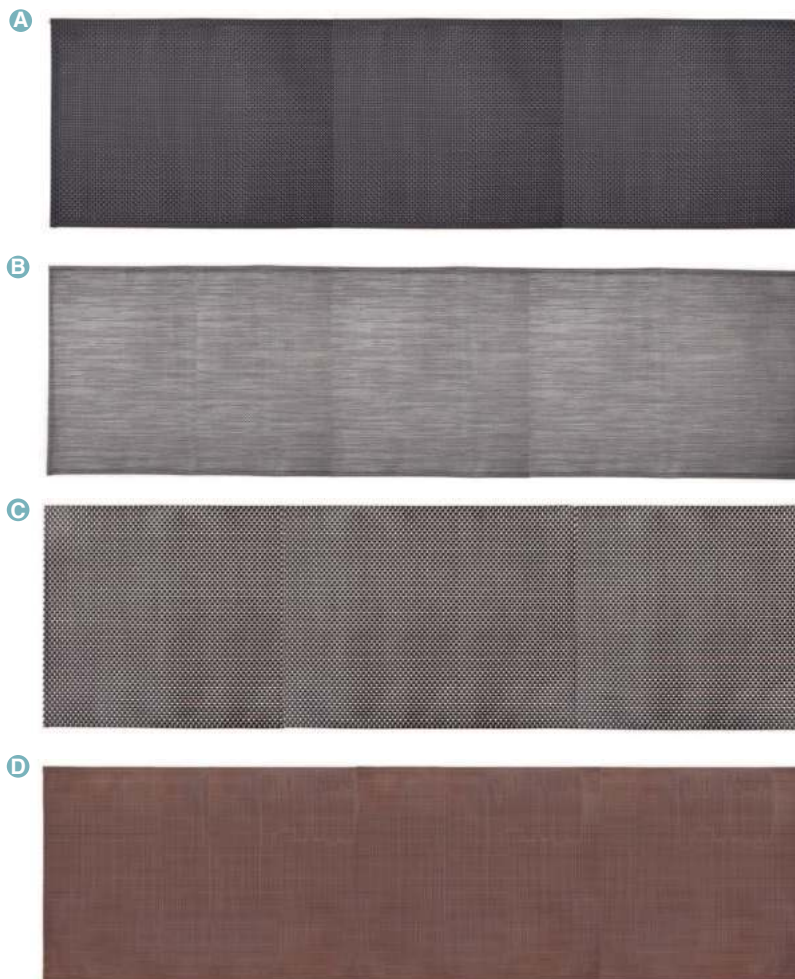

### Camino de mesa

Chemin de table  
 Tischläufer  
 Table runner  
 Corre mesa

	Ref	€	cm	U.Venta	
A	66790	10,60	40x140	1	BORNEO
B	66791	10,60	40x140	1	MANGOLE
C	66792	10,60	40x140	1	SIPURA
D	66793	10,60	40x140	1	TIMOR

**Fabricados en 75% PVC + 25% Polyester**

Fait de 75% PVC + 25% Polyester  
 Hergestellt aus 75% PVC + 25% Polyester  
 Made of 75% PVC + 25% Polyester  
 Feita de 75% PVC + 25% Polyester

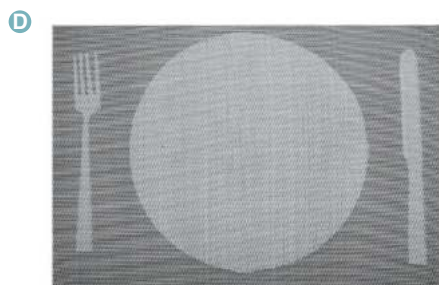
**Mantel individual**

Nappe individuel  
 Tischset  
 Individual placemat  
 Toalha de mesa individual

	Ref	€	cm	U.Venta	
A	66755	4,30	45x30	6	SAMUI
B	66756	4,30	45x30	6	KRABI
C	66757	4,30	45x30	6	TAPU
D	66758	4,30	45x30	6	SAMET

**Fabricados en PVC 100%**

Fait de 100% PVC  
 Hergestellt aus 100% PVC  
 Made of 100% PVC  
 Feita de 100% PVC

**Mantel individual**

Nappe individuel  
 Tischset  
 Individual placemat  
 Toalha de mesa individual

	Ref	€	cm	U.Venta	
A	66784	6,90	45x30	6	MASBATE
B	66785	6,90	45x30	6	LEYTE

**Fabricados en PVC 100%**

Fait de 100% PVC  
 Hergestellt aus 100% PVC  
 Made of 100% PVC  
 Feita de 100% PVC

**Mantel individual**

Nappe individuel  
 Tischset  
 Individual placemat  
 Toalha de mesa individual

	Ref	€	cm	U.Venta	
A	66787	6,90	45x30	6	DAVAO
B	66788	6,90	45x30	6	TICAO

# Colección CUBERTEROS

PP

Polypropylene



Dishwasher



BPA free

4 compartimentos  
4 compartments

Hueco  
Hollow  
11x25x9 cm



- Recipiente para cubiertos en color negro de polipropileno.
- Ideal para organizar y guardar los cubiertos e utensilios de la cocina.
- No se deforma con el peso de los cubiertos.
- Cómodo de transportar gracias a sus asas laterales.
- Fondo redondeado para un fácil mantenimiento.
- Apilable.

- Pot à couverts en polypropylène noir.
- Idéal pour organiser et ranger les couverts et les ustensiles de cuisine.
- Il ne se déforme pas avec le poids des couverts.
- Confortable à transporter grâce à ses poignées latérales.
- Fond arrondi pour un entretien facile.
- Empilable.

- Besteckbehälter aus schwarzem Polypropylen.
- Ideal zum Ordnen und Aufbewahren von Besteck und Küchenutensilien.
- Es verformt sich nicht durch das Gewicht des Bestecks.
- Bequemer Transport durch seitliche Griffe.
- Abgerundeter Boden für einfache Wartung.
- Stapelbar.

- Black polypropylene cutlery container.
- Ideal for organizing and storing cutlery and kitchen utensils.
- It does not deform with the weight of the cutlery.
- Comfortable to transport thanks to its side handles.
- Rounded bottom for easy maintenance.
- Stackable.

- Recipiente para talheres de polipropileno preto.
- Ideal para organizar e guardar talheres e utensílios de cozinha.
- Não deforma com o peso dos talheres.
- Cómodo de transportar graças às suas pegas laterais.
- Fundo arredondado para fácil manutenção.
- Empilhável.

## Cubertero GN 1/1

Range-couverts  
Besteckkasten  
Cutlery holder  
Bandeja pata talheres

Ref	€	cm	h (cm)	U.Venta
33121	11,20	52,5x32	9,5	1

new

Trenzados  
Braided



## Cubertero RATTAN PP

Range-couverts  
Besteckkasten  
Cutlery holder  
Bandeja pata talheres

	Ref	€	cm	h (cm)	Compart.	U.Venta
A	63484	8,40	27x10	4,5	1	1
B	63485	8,40	Ø12	15,0	1	1
C	63491	74,80	53x32,5	9,0	4	1

C



Bastidor cromado reforzado  
Reinforced chrome frame

4 compartimentos  
4 compartments

# Colección SALVAMANTELES



- Salvamantel magnético fabricado en roble de máxima calidad, muy agradable al tacto (63041).
- Salvamantel magnético fabricado en silicona de máxima calidad (63042).
- Diseñado para apoyar y transportar sartenes, ollas, cacerolas, etc. de forma cómoda y segura, sin riesgo a quemarse.
- Superresistente a altas temperaturas. Protege las superficies y las encimeras.
- No es apto para el lavavajillas.

- Dessous de plat magnétique fabriqué en chêne de la plus grande qualité, très agréable au toucher (63041).
- Dessous de plat magnétique fabriqué en silicone de qualité supérieure (63042).
- Conçu pour transporter et y poser des poêles, des casseroles, des faitouts, etc. de façon pratique et sûre, sans risque de se brûler.
- Très résistant aux hautes températures. Protège les surfaces et les plans de travail.
- Ne peut pas être mis au lave-vaisselle.

- Magnetischer Untersetzer aus Eichenholz höchster Qualität, sehr angenehme Textur (63041).
- Magnetischer Untersetzer aus hochwertigem Silikon (63042).
- Zum Abstellen und Transportieren von Pfannen, Kochtöpfen, Kasserollen usw. bequem, sicher, ohne sich zu verbrennen.
- Äußerst hitzebeständig. Schützt Nutz- und Arbeitsflächen.
- Nicht spülmaschinengeeignet.



- Magnetic trivet made of top quality oak with a very nice feel (63041).
- Magnetic trivet made of top quality silicone (63042).
- Designed to hold and move frying pans, pots, casseroles etc. safely and conveniently without risk of getting burned.
- Extremely resistant to high temperatures. Protects surfaces and counter tops.
- Not dishwasher safe.

- Base magnética para tachos e panelas, fabricada em carvalho da máxima qualidade, muito agradável ao tato (63041).
- Base magnética fabricada em silicone de alta qualidade (63042).
- Concebida para apoiar e transportar sertãs, panelas, caçarolas, etc., de maneira cómoda e segura, sem o risco de sofrer queimaduras.
- Super resistente a altas temperaturas. Protege as superfícies e as bancadas.
- Não é apta para máquinas de lavar louça.

## Roble

Oak

### Salvamanteles magnético

Dessous de plat magnétique  
Untersetzer, magnetisch  
Magnetic trivet  
Base para tachos magnética



**Fuerte sujeción. Potente imán integrado**

Strong holding power. Powerful built in magnet

Ref	€	cm	h (cm)	U.Venta
63041	21,20	23x20	1	1

## Si

Silicone Dishwasher

### Salvamanteles magnético GRIP

Dessous de plat magnétique  
Untersetzer, magnetisch  
Magnetic trivet  
Base para tachos magnética



**Base imantada GRIP line: 4 potentes imanes integrados**

Magnet base GRIP line; 4 strong magnet integrated

Ref	€	Ø (cm)	h (cm)	U.Venta
63042	8,30	20	0,6	1



Si

Silicone Dishwasher

## Salvamanteles UNITE

Dessous de plat  
Untersetzer  
Trivet protector  
Protector de toalhas

Ref	€	cm	h (cm)	U.Venta
63043	4,10	16x16	1	1



**Flexible y antideslizante**

Flexible and non-slip

**Superresistente a altas temperaturas**

Extremely resistant to high temperatures

**Protege las superficies y las encimeras**

Protects surfaces and counter tops



**Muy cómodo para guardar y sencillo de utilizar**

Very convenient to store and easy to use

Cerrado · closed: 12,5x12,5 cm



Inox

Si

Silicone

## Salvamanteles silicona desplegable

Dessous de plats en silicone dépliant  
Untersatz  
Silicone trivet foldable  
Protector de toalhas em silicone dobrável

Ref	€	cm	U.Venta
66752	11,10	16x16	1



**Salvamanteles desplegable**

Trivet foldable

**Proporcionan adherencia**

They provide adherence

**Soporte de acero inoxidable**

Stainless steel bracket

**Recubierto de silicona de gran calidad**

High quality silicone coated



- Originales salvamanteles fabricados con alambre de acero de alta calidad. Recubierto con pintura negro mate.
- Resistentes al calor y a los golpes.
- Ideales para colocar sartenes, cazos, cacerolas y otros artículos calientes.
- Originals trivet made of high quality steel wire. Coated with matte black paint.
- Heat and shock resistant.
- Ideals for placing pans, saucepans, saucepans and other hot items.

FE

Hierro/Iron

## Salvamanteles cuadrado

Dessous de plats carré  
Untersatz, viereckig  
Square trivet protector  
Protector de toalhas quadrado

Ref	€	cm	h (cm)	Varilla (mm)	U.Venta
61129	13,30	18,5x18,5	2,9	5x3	1
61130	17,30	25x25	2,9	5x3	1



FE

Hierro/Iron

## Salvamanteles rectangular

Dessous de plats rectangulaire  
Untersatz, rechteckiger  
Rectang. trivet protector  
Protector de toalhas rectangular

Ref	€	cm	h (cm)	Varilla (mm)	U.Venta
61131	17,30	30x20	2,9	5x3	1
61132	23,70	40x25	2,9	5x3	1



Inox  
18/10

## Salvamanteles

Dessous de plats  
Untersatz  
Trivet protector  
Protector de toalhas

Ref	€	cm	h (cm)	U.Venta
63008	18,40	23x23	2,5	1

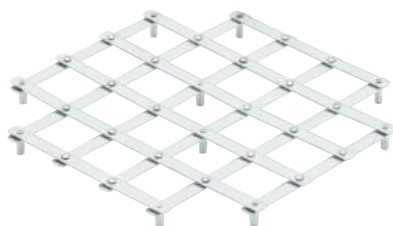

Inox

## Salvamanteles redondo

Dessous de plats rond.  
Untersatz rund  
Round trivet protector  
Protector de toalhas redondo.

Ref	€	cm	h (cm)	U.Venta
63036	16,40	20x18	2	1





# Paneras NÓRDICAS

**FE** Madera  
Caucho

Hierro/Iron Rubber Wood



- Cuerpo fabricado en acero al carbono lacado en blanco.
- Tapa fabricada en madera de caucho con orificios de ventilación para una óptima circulación del aire.
- Diseño vintage. Forma rectangular con esquinas redondeadas.
- Diseñado para conservar el pan y otros productos siempre frescos.
- 2 en 1: la tapa de madera de caucho se puede utilizar como tabla de cortar.
- Almacenamiento compacto.
- Fácil limpieza.

- Corps fabriqué en acier carbone laqué en blanc.
- Couvercle fabriqué en bois d'hévéa avec des orifices d'aération pour une circulation optimale de l'air.
- Style vintage. Forme rectangulaire avec angles arrondis.
- Conçue pour conserver le pain et d'autres produits toujours frais.
- 2 en 1 : Le couvercle en bois d'hévéa peut être utilisé comme planche à découper.
- Rangement compact.
- Facile à nettoyer.

- Unterteil aus Kohlenstoffstahl, weiß lackiert.
- Deckel aus Kautschukholz mit Öffnungen für eine optimale Luftzirkulation.
- Retro-Design. Rechteckig mit abgerundeten Ecken.
- Hält Brot und andere Produkte frisch.
- 2-in-1-Design: Deckel aus Kautschukholz kann als Schneidbrett verwendet werden.
- Platzsparende Aufbewahrung.
- Einfach zu reinigen.

- The body is made of carbon steel with white lacquer.
- The lid is made of rubberwood with ventilation holes for optimum air circulation.
- It has a vintage design. It is rectangular with rounded corners.
- It is designed to keep bread and other products always fresh.
- 2 in 1: The rubberwood lid can be used as a cutting board.
- Compact storage.
- Easy to clean.

- Corpo fabricado em aço-carbono lacado a branco.
- Tampa fabricada em madeira da árvore-da-borracha, com orifícios de ventilação para melhor circulação do ar.
- Design vintage. Forma retangular com esquinas arredondadas.
- Para conservar sempre frescos o pão e outros produtos alimentares.
- 2 em 1: A tampa de madeira da árvore-da-borracha pode utilizar-se como tábua de cortar.
- Armazenamento compacto.
- Fácil de limpar.

## Panera NÓRDICA

Boîte à pain  
Brotkasten  
Bread basket  
Caixa para guardar pão



	Ref	€	cm	h (cm)	U.Venta
A	62868	38,60	30x18	12,5	1
B	62869	41,90	42x22,5	12,5	1

**Mantiene el pan protegido y prolonga su conservación**  
Keeps the bread protected and prolong its conservation



**Puerta abatible**  
Folding door

**Capacidad suficiente para todo tipo de panes**  
Sufficient capacity for all kinds of breads

**Inox**

## Panera abatible

Paniere rabattabile  
Abfällen Brotkorb  
Bread bin foldable lid  
Cestonreclinável

	Ref	€	cm	h (cm)	U.Venta
	62944	41,90	44x29	19	1

# Colección PANERAS · FRUTEROS



- Fabricadas en fibra virgen natural.
- Material ecológico y respetuoso con el medio ambiente.
- Lavables, resistentes y duraderas.
- Diseñadas y fabricadas en España.
- Hechas a mano.
- Tacto agradable y suave, similar a la piel. Espesor 0,55 mm.

- Fabriquées en fibres vierges naturelles.
- Matériau écologique et respectueux de l'environnement.
- Lavables, résistantes et durables.
- Conçues et fabriquées en Espagne.
- Faites à la main.
- Toucher agréable et doux, similaire au cuir. Épaisseur de 0,55 mm.

- Aus naturreiner Faser.
- Umweltverträgliches Öko-Material.
- Waschbar, robust und langlebig.
- Design und Herstellung in Spanien.
- Handgefertigt.
- Weich und angenehm wie Leder. 0,55 mm dick.

- Made of natural virgin fibre.
- Ecological material respectful with the environment.
- Washable, resistant and durable.
- Designed and manufactured in Spain.
- Handmade.
- Nice soft feel, similar to leather. Thickness 0.55 mm.

- Fabricados em fibra virgem natural.
- Material ecológico, respeitador do meio ambiente.
- Laváveis, resistentes e duráveis.
- Desenhados e fabricados em Espanha.
- Fabricados à mão.
- Tato agradável e suave, similar ao do couro. Espessura 0,55 mm.



A

B

C

D



## Panera KRAFT

Boîte à pain  
Brotkasten  
Bread basket  
Caixa para guardar pão

	Ref	€	cm	h max (cm)	h min (cm)	U.Venta
A	63476	13,40	10x10	25	8	1
B	63477	14,30	12x12	25	12	1
C	63478	16,20	15x15	25	12	1
D	63479	18,70	20x20	33	12	1

A

B

C

D



## Panera TEX

Boîte à pain  
Brotkasten  
Bread basket  
Caixa para guardar pão

	Ref	€	cm	h max (cm)	h min (cm)	U.Venta
A	63486	13,40	10x10	25	8	1
B	63487	14,30	12x12	25	12	1
C	63488	16,20	15x15	25	12	1
D	63489	18,70	20x20	33	12	1

PP



Polypropilene

Stackable

Dishwasher

BPA free



- Cestas para pan fabricadas en polipropileno. Diseñadas para uso intensivo.
- Estructura de refuerzo de acero inoxidable. Parte trasera más alta que proporciona suficiente apoyo para panes largos (63492-63493).
- Material con aspecto de mimbre muy resistente, libre de BPA.
- Elaboradas a mano.
- Prácticas e higiénicas. Acabado en mate.
- Ideales para almacenar y exponer panes.
- Apilables.
- Fácil limpieza.

- Paniers pour pain fabriqués en polypropylène. Conçu pour une utilisation intensive.
- Structure renforcée en acier inoxydable. Partie arrière plus haute afin d'offrir un meilleur support aux pains longs (63792-63493).
- Matériau très résistant à l'aspect de rotin, sans BPA.
- Fait à la main.
- Pratiques et hygiéniques. Fini mat.
- Parfaits pour ranger et exposer des pains.
- Empilables.
- Faciles à nettoyer.

- Brotkorb aus Polypropylen. Auswahl für den intensiven Gebrauch.
- Verstärkung aus Edelstahl. Hinten mit höherer Auflagefläche für längliches Brot (63792-63493).
- In Flechtoptik, sehr widerstandsfähig, BPA-frei.
- Handgemacht.
- Praktisch und hygienisch. Matt Oberfläche entwickelt.
- Optimal zum Aufbewahren und Präsentieren von Brot geeignet
- Stapelfähig.
- Einfache Reinigung.

- These bread baskets are made of polypropylene. Designed for intensive use.
- Stainless steel reinforcement structure. The taller back gives plenty support for long loaves of bread (63792-63493).
- The very strong material looks like wicker and it's BPA free.
- Handmade.
- They're practical and hygienic. Matte finish.
- Perfect for storing or displaying bread.
- Stackable.
- Easy to clean.

- Cestas para o pão fabricadas em polipropileno. Projetado para uso intensivo.
- Estrutura reforçada em aço inoxidável. A parte traseira mais alta oferece suficiente apoio para pães mais compridos (63792-63493).
- Material resistente a imitar vime, sem BPA.
- Feito à mão.
- Práticas e higiénicas. Acabamento fosco.
- Ideais para armazenar e expor o pão.
- Empilháveis.
- Fáceis de limpar.

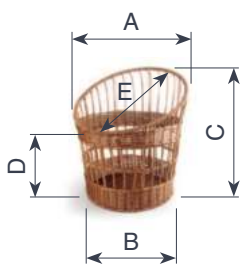

Estructura de refuerzo de acero inoxidable  
Stainless steel reinforcement structure

A



B



new

Inox

**Cesta baguette**

Corbeille  
Brotkorb  
Basket  
Cesta

A		B							
Ref	€	Ref	€	ØA (cm)	ØB (cm)	C (cm)	D (cm)	E (cm)	U.Venta
63492	62,70	63493	62,70	32,0	28,5	42,0	25,0	36,5	1



### Cesta de pan redonda

Corbeille a pain ronde  
Brotkorb, rund  
Round bread basket  
Cesta de pão redonda

A		B				
Ref	€	Ref	€	Ø (cm)	h (cm)	U.Venta
63471	7,70	63871	7,80	19	8	1
63472	8,60	63872	8,60	21	8	1
63473	9,20	63873	9,20	23	8	1
63474	9,80	63874	9,90	26	8	1

### Cesta de pan oval

Corbeille a pain ovale  
Brotkorb, Oval  
Oval bread basket  
Cesta de pão oval

A		B				
Ref	€	Ref	€	cm	h (cm)	U.Venta
63480	7,00	63880	7,00	19x14	8,0	1
63481	8,30	63881	8,20	24x17	8,0	1
63482	10,10	63882	10,10	28x16	8,5	1



### Cesta de pan

Corbeille a pain  
Brotkorb  
Bread basket  
Cesta de pão

A		B			
Ref	€	Ref	€	Ø (cm)	U.Venta
63494	30,00	63894	29,50	35x20	1



### Cesta de pan cuadrada

Corbeille a pain carré  
Brotkorb, vierekigl  
Square bread basket  
Cesta de pão quadrada

A		B			
Ref	€	Ref	€	cm	U.Venta
63490	34,30	63890	34,00	53x33,5x9	1

**Alambre de acero.**  
**Acabado en negro mate**  
Steel wire.  
Matte black finish

**Ideales para almacenar fruta, pan, verduras, huevos, etc.**  
Can be used for storing fruit, bread, vegetables, eggs, etc.



**Resistentes y duraderos**  
Resistant and durable

**FE**

Hierro/Iron

**Frutero varillas**

Corbeille à fruits  
Obstschale aus Gitterstäben  
Rod fruit bowl  
Cesto de metal para fruta

	Ref	€	Ø (cm)	h (cm)	ØVarilla (mm)	U.Venta
<b>A</b>	61126	22,90	23,4	25,4	4	2
<b>B</b>	61127	20,80	27,0	13,8	4	1
<b>C</b>	61128	22,00	34,0	9,5	4	1

**Madera contrachapada color haya**  
Plywood beech color



**Frutero varillas**

Corbeille à fruits  
Obstschale aus Gitterstäben  
Square fruit bowl  
Cesto de metal para fruta

	Ref	€	Cesta (cm)	h Total (cm)	ØVarilla (mm)	U.Venta
<b>A</b>	61137	34,40	26x26x18,3	27,8	4	1
<b>B</b>	61138	34,40	Ø25,2x17,7	28,9	4	1



Madera  
Aglomerada  
Agglomerate  
Wood

**Frutero varillas redondo bajo**

Corbeille à fruits ronde basse  
Obstschale aus Gitterstäben  
Round low rod fruit bowl  
Cesto de metal para fruta redondo baixo

Ref	€	Cesta (cm)	h (cm)	Ø Base (mm)	ØVarilla (mm)	U.Venta
61139	39,70	Ø39x6	7,6	31,3	4	1

Madera  
Caucho

Rubber Wood



**Inox**

**Frutero - Panera Inox.**

Paniere à fruit et à pain  
Brot-/Obstschale  
Fruits and bread basket.  
Fruteiro-Cesto



**Frutero varillas DUAL**

Corbeille à fruits  
Obstschale aus Gitterstäben  
Rod fruit bowl  
Cesto de metal para fruta

Ref	€	Grande (cm)	Peq. (cm)	h (cm)	ØVarilla (mm)	U.Venta
61140	53,40	Ø40x10	Ø24x10	63	4	1

Ref	€	Ø (cm)	U.Venta
61821	7,50	20	1
61823	11,30	24	1

# Fondue ROSSO



Prepara deliciosas fondues de chocolate, queso, verduras, carne, etc.  
Prepare delicious fondue with chocolate, cheese, vegetables or meats, etc.



- Fondue fabricada en hierro fundido esmaltado de máxima calidad.
- Interior y exterior esmaltado que garantiza una distribución del calor uniforme sin puntos de sobrecalentamiento.
- No absorbe la humedad, los sabores, ni los olores de los alimentos.
- Diseñado para preparar deliciosas fondues de chocolate, queso, verduras, carne, etc.
- Gracias a sus dos asas laterales se puede transportar de forma segura.
- Cuenta con protección contra las salpicaduras, soporte de hierro colado y base de madera para mayor estabilidad. Además, incluye quemador de gel combustible (gel no incluido).
- La olla tiene 16,5 cm de diámetro y una capacidad de 1,2 L.
- Apta para todas las fuentes de calor, incluida la inducción.
- Incluye 6 tenedores de acero inoxidable con mango de madera y marcas de colores.

- Appareil à fondue fabriqué en fonte d'aluminium émaillée de la plus grande qualité.
- Intérieur et extérieur émaillés, garantissant ainsi une distribution uniforme de la chaleur sans points de surchauffe.
- N'absorbe ni l'humidité, ni les goûts, ni les odeurs des aliments.
- Conçu pour préparer de délicieuses fondues au chocolat, fromage, légumes, viande, etc.
- Grâce à ses deux poignées latérales, il peut être transporté en toute sécurité.
- Possède une protection contre les éclaboussures, un support en métal coulé et une base en bois pour une meilleure stabilité. De plus, il inclut un brûleur de gel combustible (gel non inclus).
- Le récipient mesure 16,5 cm de diamètre et a une capacité de 1,2 L.
- Apte pour toutes les sources de chaleur, y compris l'induction.
- Inclut 6 piques en acier inoxydable avec manche en bois et marques de couleur.

- Fondue pot made of top quality enamelled cast iron.
- Enamelled inside and out to guarantee even heat distribution without overheating points.
- Does not absorb humidity, flavours or odours from food.
- Designed to prepare delicious fondue with chocolate, cheese, vegetables or meats, etc.
- It can be handled safely thanks to its two side handles.
- It has splash protection, a cast iron support and a wooden base for greater stability. It also has a flammable gel burner (gel not included).
- The pot is 16.5 cm in diameter and has a 1.2 L capacity.
- It can be used with all heat sources, including induction.
- There are 6 stainless steel forks with wooden handles and coloured marks included.

**Gel de origen orgánico. No produce emanaciones tóxicas. Encendido rápido y combustión silenciosa, limpia, inodora, sin humos y sin cenizas.**

Organic gel fuel. Does not produce toxic fumes. Quick-lighting and quiet-burning, clean, odourless, smokeless and ash-free.

**6 tenedores. Marcas de colores**  
6 forks. Color markings

**Protección salpicaduras**  
Splash protection

**Soporte de hierro colado**  
Cast iron support



## Gel combustible ETANOL

Gel chauffe ETHANOL  
Brennpaste, ETHYALKOHOL  
Fuel gel, ETHANOL  
Gel combustível ETANOL

	Ref	€	Kg	Horas	U.Venta	
A	71780	4,80	0,08	80 min	1	Set 3 latas · 3 can set
B	69108	2,70	0,225	3	72	Lata · Can
C	69107	8,60	0,840	-	1	Botella · Bottle
D	69109	39,40	4,00	-	1	Bidón · Barrel

## Fondue ROSSO

Fondue  
Fondue  
Fondue  
Fonduel

Ref	€	L	U.Venta
71711	62,20	1,20	1



- Fabricadas en aluminio fundido de máxima calidad.
- Ideales tanto para cocinar como para presentar aperitivos o platos.
- Antiadherente bicapa de alta calidad y 100% libre de PFOA.
- Libres de materiales tóxicos, pesados, disolventes y sustancias químicas.
- Diseñadas para una cocina saludable: permite cocinar sin apenas aceite garantizando que los alimentos no se peguen.
- Distribución homogénea del calor que permite una cocción rápida y uniforme.
- Aptas para todo tipo de fuegos: gas, eléctrica, vitrocerámica e inducción.
- Tapa fabricada en vidrio templado con válvula de salida de vapor. Pomo baquelita con acabado Soft Touch. Mango ergonómico con acabado Soft Touch.

- Fabriqué en fonte d'aluminium de la plus grande qualité.
- Idéale aussi bien pour cuisiner que pour la présentation d'apéritifs ou de plats.
- Finition antiadhésive bi-couche de grande qualité et 100% sans PFOA.
- Sans matériaux toxiques, métaux lourds, dissolvants et substances chimiques.
- Conçue pour une cuisine saine : permet de cuisiner sans à peine utiliser d'huile et avec la garantie que les aliments ne collent pas.
- Distribution homogène de la chaleur, ce qui permet une cuisson rapide et uniforme.
- Apte pour tous types de feux : gaz, électricité, vitrocéramique, four et induction.
- Couvercle fabriqué en verre trempé avec valve à vapeur et poignée en bakélite avec finition Soft Touch. Manche ergonomique avec finition Soft Touch.

- Kasserolle aus einteiligem Aluminiumguss bester Qualität.
- Ideal zum Kochen und Anrichten von Vor- oder Hauptspeisen.
- Hochwertige zweilagige Antihafbeschichtung ohne PFOA.
- Ohne Giftstoffe, Schwermetalle, Lösungsmittel und chemische Stoffe.
- Für eine gesunde Küche: Schon wenig Öl reicht aus und es bleibt garantiert nichts kleben.
- Gleichmäßige Wärmeverteilung sorgt für schnelle und einheitliche Ergebnisse.
- Für alle Herdarten geeignet: Gas, Elektro, Glaskeramik, Backofen und Induktion.
- Deckel aus Hartglas mit Dampfabzug und Soft Touch-Knauf aus Bakelit.

- Made from a single piece of top quality cast aluminium.
- It's perfect for both cooking and presenting appetisers or dishes.
- It has a high quality bi-layer non-stick coating that is 100% PFOA free.
- It's free of toxic materials, heavy metals, solvents and chemical substances.
- It's designed for healthy cooking. It lets you cook with practically no oil and be sure that food won't stick.

- Food is cooked quickly and evenly because of the homogeneous heat distribution.
- It's suitable for all kinds of cookers: gas, electric, vitroceramic, oven and induction.
- The lid is made of tempered glass with a steam valve and has a bakelite handle with a Soft Touch finish. Ergonomic handle with a Soft Touch finish.

## Cacerola con tapa

Faitout avec couvercle  
Bratentopf mit Deckel  
Casserole with lid  
Çaçarola com tampa



Ref	€	Ø (cm)	ØBase (cm)	h (mm)	e (mm)	L	U.Venta
25160	20,90	16	12,0	5,0	1,6	0,8	1

- Fabricadas em alumínio fundido de qualidade superior.
- Ideal para cozinhar e também para servir aperitivos ou pratos
- Acabamento antiaderente bi-capa de alta qualidade, 100% livre de PFOA.
- Não contém materiais tóxicos nem pesados, dissolventes e substâncias químicas.
- Pensada para uma cozinha saudável, permitem cozinhar praticamente sem azeite nem óleo, sem que os alimentos agarrem ao fundo.
- Distribuição homogénea do calor para uma cocção rápida e uniforme.
- Apta para todo o tipo de fogões: A gás, elétricos, placas de vitrocerâmica e de indução.
- Tapa fabricada em vidro temperado, com válvula de saída de vapor e pega de baquelite com acabamento Soft Touch. Cabo ergonómico com acabamento Soft Touch.

## Paellera

Plat à paella  
Pfanne  
Round dish  
Paelheira



Ref	€	Ø (cm)	ØBase (cm)	h (mm)	e (mm)	L	U.Venta
25161	20,90	20	11,5	4,5	1,8	1,0	1

## Sartén

Poêle  
Pfanne  
Frying pan  
Sertã



Ref	€	Ø (cm)	ØBase (cm)	h (mm)	e (mm)	U.Venta
25163	12,80	14	10,0	3,0	1,6	1

## Cazo recto

Casserole  
Stielkasserole, flach  
Saucepan  
Çaçarola direita



Ref	€	Ø (cm)	ØBase (cm)	h (mm)	e (mm)	L	U.Venta
25164	16,20	14	10,0	8,0	1,6	1,0	1

## Grill

Grill  
Grill Induktionfähig  
Grill  
Grilhador



Ref	€	cm	ØBase (cm)	h (mm)	e (mm)	U.Venta
25162	14,10	14x14	10,0	2,5	1,6	1

# Colección **MINI-COCOTTES**



- Fabricadas en aluminio fundido. Diseño atractivo y funcional.
- Garantizan la absorción y distribución uniforme del calor, sin puntos de sobrecalentamiento.
- La distribución del calor uniforme por toda la pieza hace que los alimentos no pierdan su jugo durante la cocción, conservando así todos sus nutrientes y vitaminas.
- Las puntas situadas bajo la tapa, hacen que las gotas fruto de la condensación, vuelvan a caer sobre los alimentos formando un flujo circulante y permanente reduciendo la pérdida de sabores y jugos de los alimentos.
- Es la pieza perfecta para: arroces, carnes, pescados, legumbres, verduras, guisos, cremas, salsas, sopas, etc.
- Revestimiento antiadherente ILAG:ULTIMATE.

- Fabriquée en fonte d'aluminium. Style attractif et grande fonctionnalité.
- Garantit l'absorption et la distribution uniforme de la chaleur, sans points de surchauffe.
- La distribution de la chaleur uniforme sur toute la pièce permet aux aliments de ne pas perdre leur jus pendant la cuisson, conservant ainsi tous leurs nutriments et vitamines.
- Les pointes situées sous le couvercle permettent aux gouttes issues de la condensation de retomber sur les aliments, formant ainsi un flux permanent de circulation qui réduit la perte des saveurs et des jus des aliments.
- C'est la pièce parfaite pour : riz, viandes, poissons, légumes, ragoûts, crèmes, sauces, soupes, etc.
- Revêtement antiadhésif ILAG: ULTIMATE.
- Made in cast aluminium. Attractive design and great functionality.
- It guarantees the absorption and uniform distribution of heat, without overheating points.
- The uniform distribution of heat throughout the product makes keep its juices during cooking, preserving all its nutrients and vitamins.
- The points located under the lid cause the condensation drops to fall back onto the food, forming a permanent and circulating flow and reducing the loss of the food's flavours and juices.
- This is an ideal product for: rice, meats, fish, beans, vegetables, stews, creams, sauces, soups, etc.
- Non-stick coating ILAG: ULTIMATE.



**Las puntas situadas bajo la tapa, hacen que las gotas fruto de la condensación, vuelvan a caer sobre los alimentos formando un flujo circulante y permanente reduciendo la pérdida de sabores y jugos de los alimentos.**

The points located under the lid cause the condensation drops to fall back onto the food, forming a permanent and circulating flow and reducing the loss of the food's flavours and juices.

## Cacerola con tapa MINI

Faitout avec couvercle "MINI"  
"MINI" Bratentopf mit Deckel  
"MINI" round casserole with lid  
Çaçarola com tampa "MINI"



Ref	€	Ø (cm)	h (cm)	L	U.Venta
25909	22,50	10	5,0	0,24	12
25914	33,00	14	7,5	0,90	1

## Cacerola con tapa MINI negra

Faitout avec couvercle MINI noir  
MINI Bratentopf mit Deckel, grau  
"MINI" black round casserole with lid  
Çaçarola com tampa MINI negra



Ref	€	Ø (cm)	h (cm)	L	U.Venta
25910	22,50	10	5,0	0,24	1
25915	33,00	14	7,5	0,90	1

## Cacerola oval con tapa MINI

Faitout Ovale avec couvercle "MINI"  
"MINI" Oval Bratentopf mit Deckel  
"MINI" oval round casserole with lid  
Çaçarola oval com tampa "MINI"



Ref	€	cm	h (cm)	L	U.Venta
25911	23,70	12x8,5	5,0	0,25	1

## Cacerola oval c/tapa MINI negra

Faitout ovale avec couvercle MINI noir  
MINI Oval Bratentopf mit Deckel, grau  
"MINI" black oval round casserole with lid  
Çaçarola oval com tampa MINI negra



Ref	€	cm	h (cm)	L	U.Venta
25912	22,40	12x8,5	5,0	0,25	1

**HINWEIS: In Deutschland nicht verfügbar**



# Colección MAGMA



**Hierro Fundido**  
Cast Iron

- Construida en una sola pieza.
- Recubierta con una capa de aceite vegetal.
- Ideal para cocinar, prolonga suavemente la cocción.
- Gran conductor del calor, mantiene el calor mientras disfrutas y saboreas la comida.
- Base de madera para servir y presentar la comida recién cocinada.

- Construite en une seule pièce.
- Revêtu d'une couche d'huile végétale.
- Idéal pour cuisiner, prolonge délicatement la cuisson.
- Grand conducteur de chaleur, maintient le plat au chaud pendant que vous dégustez la nourriture.
- Base en bois pour servir et présenter le plat fraîchement cuisiné.

- Aus einem Stück gefertigt.
- Beschichtet mit einer Schicht von Pflanzenöl.
- Ideal zum Kochen, verlängert den Kochvorgang auf sanfte Weise.
- Hervorragender Wärmeleiter; erhält die Wärme während Sie die Speisen genießen.
- Holzbasis, auf der das soeben zubereitete Gericht serviert und präsentiert wird.

- Built in one piece.
- Coated with a layer of vegetable oil.
- Ideal for cooking; gently continues to cook.
- Great heat conductor; retains heat while you enjoy and savour the food.
- Wooden base to serve and present freshly cooked food.

- Elementos fabricados a partir de uma única peça.
- Revestidos com uma camada de óleo vegetal.
- Ideal para cozinhar, prolonga suavemente a cocção.
- Excelente condutor do calor, mantém o calor enquanto desfrutas da comida.
- Base de madeira para servir e apresentar a comida recém-preparada.

## Cacerola con base

Faitout avec basse  
Bratentopf mit Holzsockel  
Casserola with base  
Caçarola com base



Ref	€	Ø (cm)	ml	U.Venta
25871	15,40	12,5	230	4
25872	21,00	16,2	470	1
25873	27,00	18,5	720	1

## Cacerola

Faitout  
Bratentopf  
Casserola  
Caçarola



Ref	€	Ø (cm)	ml	U.Venta
25771	10,70	12,5	230	4
25772	15,60	16,2	470	4
25773	18,80	18,5	720	1

## Cacerola oval con base

Faitout ovale avec basse  
Oval Bratentopf mit Holzsockel  
Oval casserola with base  
Caçarola oval com base



Ref	€	cm	ml	U.Venta
25881	15,60	15x10	200	4
25882	24,00	17,5x12,5	300	1
25883	26,70	21,7x15	700	1

## Cacerola oval

Faitout ovale  
Oval Bratentopf  
Oval casserola  
Caçarola oval



Ref	€	cm	ml	U.Venta
25781	12,10	15x10	200	4
25782	19,00	17,5x12,5	300	1
25783	21,60	21,7x15	700	1



### Mini plancha grill lisa rectangular con base

Mini plaque grill lisse rectangulaire avec basse  
Mini Platte grill, glatt, rechteckiger mit Holzsocket  
Mini rectangular grill plaque flat with base  
Mini plancha grill liso rectangular com base

Ref	€	cm	h (cm)	U.Venta
25874	15,00	17x10	2,5	4



### Mini plancha grill lisa rectangular

Mini plaque grill lisse rectangulaire  
Mini Platte grill, glatt, rechteckiger  
Mini rectangular grill plaque flat  
Mini plancha grill liso rectangular

Ref	€	cm	h (cm)	U.Venta
25774	10,20	17x10	2,5	4



### Mini plancha grill cuadrado c/base

Mini plaque grill carré ave basse  
Mini Platte grill, Quadrat mit Holzsocket  
Mini square grill plaque with base  
Mini plancha grill cuadrado com base

Ref	€	cm	h (cm)	U.Venta
25875	15,00	14x14	1,7	4



### Mini plancha grill cuadrado

Mini plaque grill carré  
Mini Platte grill, Quadrat  
Mini square grill plaque  
Mini plancha grill cuadrado

Ref	€	cm	h (cm)	U.Venta
25775	10,70	14x14	1,7	4



### Mini grill con base

Mini grill avec basse  
Mini grill mit Holzsocket  
Mini grill with base  
Mini grill com base

Ref	€	cm	h (cm)	U.Venta
25876	17,30	14x14	2,5	1



### Mini grill

Mini grill  
Mini grill  
Mini grill  
Mini grill

Ref	€	cm	h (cm)	U.Venta
25776	11,10	14x14	2,5	4



### Mini sartén lisa c/base

Mini poêle lisse avec basse  
Mini Pfanne mit Holzsocket  
Mini frying pan flat with base  
Mini sertã lisa com base

Ref	€	Ø (cm)	h (cm)	U.Venta
25877	16,10	13	1,7	1



### Mini sartén lisa

Mini poêle lisse  
Mini Pfanne  
Mini frying pan flat  
Mini sertã lisa

Ref	€	Ø (cm)	h (cm)	U.Venta
25777	11,20	13	1,7	4

# Colección MAGMA GREY & RED



- Acabado exterior e interior esmaltado, muy resistente y de gran durabilidad.
- Muy versátiles: ideal para cocinar asados, arroces, pasta, cocer a fuego lento e incluso hornear tartas dulces y pan.
- Conserva todos los nutrientes, vitaminas y sabores de los alimentos.
- Excelente retención y distribución uniforme del calor.
- Incluye base de madera, ideal para servir y presentar.
- Aptas para todo tipo de fuegos.

- Finition extérieure et intérieure émaillée. Émail très résistant et d'une grande durabilité.
- Très versatile : idéale pour cuisiner des ragoûts, du riz, des pâtes, cuire à feu doux et même enfourner des gâteaux et du pain.
- Conserve tous les nutriments, les vitamines et les saveurs des aliments.
- Excellente rétention et distribution uniforme de la chaleur.
- Inclut une base en bois, idéale pour servir et présenter.
- Apte pour tous types de feux.

- Emailierte Außen- und Innenflächen. Sehr beständige und langlebige Emailierung.
- Sehr vielseitig: ideal zum Kochen, Braten und Garen, zum Bereiten von Nudeln und Reis und sogar zum Kuchen und Brot backen.
- Erhält Nährstoffe, Vitamine und Geschmack der Nahrungsmittel.
- Äußerst gleichmäßige Wärmeaufnahme und -verteilung.
- Inkl. Holzuntersatz -ideal zum Servieren und Anrichten.
- Für alle Herdarten geeignet.

- Enamel finish inside and outside. Very strong and durable enamel.
- Extremely versatile: perfect for roasts, rice, pasta, low heat cooking and even baking bread or cake.
- Preserves all the nutrients, vitamins and flavours of the food.
- Excellent heat retention and uniform heat distribution.
- Wooden base included, perfect for serving or presentation.
- Appropriate for all kinds of cookers.

- Acabamento exterior e interior esmaltado, muito resistente e de grande durabilidade.
- Grande versatilidade: ideal para cozinhar assados, arroz, massas, cocção a fogo lento e inclusive para cozer no forno tartes doces e pão.
- Conserva todos os nutrientes, vitaminas e sabores dos alimentos.
- Excelente retenção e distribuição uniforme do calor.
- Inclui base de madeira, ideal para servir e apresentar.
- Aptas para todo o tipo de fogões.

## Cacerola redonda GREY

Faitout rond  
Rund Bratentopf  
Round casserole  
Caçarola redonda



Ref	€	Ø (cm)	h (cm)	ml	U.Venta
25841	17,60	12,0	3,0	200	1
25848	27,30	16,2	3,0	470	1
25849	33,90	18,5	3,0	720	1

## Cacerola redonda RED

Faitout rond  
Rund Bratentopf  
Round casserole  
Caçarola redonda



Ref	€	Ø (cm)	h (cm)	ml	U.Venta
25851	17,60	12,0	3,0	200	1
25858	27,30	16,2	3,0	470	1
25859	33,90	18,5	3,0	720	1

## Cacerola oval GREY

Faitout ovale  
Oval Bratentopf  
Ocal casserole  
Caçarola oval



Ref	€	cm	h (cm)	ml	U.Venta
25842	23,50	17,5x12,5	3,0	250	1
25840	33,80	21,7x15	3,0	700	1

## Cacerola oval RED

Faitout ovale  
Oval Bratentopf  
Ocal casserole  
Caçarola oval



Ref	€	cm	h (cm)	ml	U.Venta
25852	23,70	17,5x12,5	3,0	250	1
25850	34,10	21,7x15	3,0	700	1

### Sartén GREY

Poêle  
Pfanne  
Frying pan  
Sertă



Ref	€	Ø (cm)	h (cm)	ml	U.Venta
25843	17,70	13,5	3,0	275	1

### Sartén RED

Poêle  
Pfanne  
Frying pan  
Sertă



Ref	€	Ø (cm)	h (cm)	ml	U.Venta
25853	17,70	13,5	3,0	275	1

### Cacerola rectang. c/tapa GREY

Faitout rectangulaire avec couvercle  
Bratentopf, rechteckig mit Deckel  
Rectangular casserole with lid  
Caçarola rectangular com tampa



Ref	€	cm	h (cm)	ml	U.Venta
25845	33,40	13x9	4,5	300	1

### Cacerola rectang. c/tapa RED

Faitout rectangulaire avec couvercle  
Bratentopf, rechteckig mit Deckel  
Rectangular casserole with lid  
Caçarola rectangular com tampa



Ref	€	cm	h (cm)	ml	U.Venta
25855	33,40	13x9	4,5	300	1

### Cacerola redonda c/tapa GREY

Faitout rond avec couvercle  
Rund Bratentopf mit Deckel  
Round casserole with lid  
Caçarola redonda com tampa



Ref	€	Ø (cm)	h (cm)	ml	U.Venta
25846	28,50	10	5,0	200	1

### Cacerola redonda c/tapa RED

Faitout rond avec couvercle  
Rund Bratentopf mit Deckel  
Round casserole with lid  
Caçarola redonda com tampa



Ref	€	Ø (cm)	h (cm)	ml	U.Venta
25856	28,50	10	5,0	200	1

### Cacerola oval c/tapa GREY

Faitout ovale avec couvercle  
Oval Bratentopf mit Deckel  
Oval casserole with lid  
Caçarola oval com tampa



Ref	€	cm	h (cm)	ml	U.Venta
25847	33,80	13x10	5,0	400	1

### Cacerola oval c/tapa RED

Faitout ovale avec couvercle  
Oval Bratentopf mit Deckel  
Oval casserole with lid  
Caçarola oval com tampa



Ref	€	cm	h (cm)	ml	U.Venta
25857	33,80	13x10	5,0	400	1

# Colección **MAGMA MELAMINA**



- Fabricadas en melamina de alta calidad.
- Libre de BPA.
- Ofrecen un aspecto muy natural parecido al hierro fundido.
- Ideal para servir y presentar los platos más exquisitos.

- Fabriqué en mélamine de haute qualité.
- Sans BPA.
- Aspect très naturel, semblable à la fonte d'aluminium.
- Idéale pour servir et présenter les plats les plus exquis.

- Hergestellt aus hochwertigem Melamin.
- Ohne BPA.
- Sehr natürliches Aussehen, ähnlich wie Gusseisen.
- Ideal zum Servieren und Anrichten erlesener Gerichte.

- Made of high quality melamine.
- BPA free.
- Very natural appearance similar to cast iron.
- Perfect for serving and presenting the most exquisite dishes.

- Fabricado em melamina de alta qualidade.
- Sem BPA.
- Aspecto natural similar ao ferro fundido.
- Ideal para servir e apresentar os pratos mais esquisitos.

## Cacerola redonda

Faitout rond  
Rund Bratentopf  
Round casserole  
Çaçarola redonda

Ref	€	Ø (cm)	U.Venta
63384	5,10	16	12
63385	6,20	18	12



## Cacerola oval

Faitout ovale  
Oval Bratentopf  
Oval casserole  
Çaçarola roval

Ref	€	cm	U.Venta
63388	4,50	18x12	12
63389	5,80	21x15	12



## Wok

Wok  
Wok  
Wok  
Wok

Ref	€	Ø (cm)	U.Venta
63386	4,30	15	12
63387	5,90	18	12



## Mini grill

Mini grill  
Mini grill  
Mini grill  
Mini grill

Ref	€	cm	U.Venta
63382	7,40	13,5x13,5	6



## Mini sartén

Mini pôele  
Mini Pfanne  
Mini frying pan  
Mini sertã

Ref	€	Ø (cm)	U.Venta
63381	7,00	15	6



## Mini sartén rectangular

Mini pôele rectangulare  
Mini Pfanne, rechteckiger  
Rectangular Mini frying pan  
Mini sertã rectangular

Ref	€	cm	U.Venta
63383	5,10	17x11,5	12



# Colección MINI-COCOTTE MELAMINA



- Fabricadas en melamina de alta calidad. Libre de BPA.
- Ofrecen un aspecto muy natural parecido al hierro fundido.
- Ideales para servir y presentar los platos más exquisitos.

- Fabriqué en mélamine de haute qualité. Sans BPA.
- Aspect très naturel, semblable à la fonte d'aluminium.
- Idéale pour servir et présenter les plats les plus exquis.

- Hergestellt aus hochwertigem Melamin. Ohne BPA.
- Sehr natürliches Aussehen, ähnlich wie Gusseisen.
- Ideal zum Servieren und Anrichten erlesener Gerichte.

- Made of high quality melamine. BPA free.
- Very natural appearance similar to cast iron.
- Perfect for serving and presenting the most exquisite dishes.

- Fabricado em melamina de alta qualidade. Sem BPA.
- Aspecto natural similar ao ferro fundido.
- Ideales para servir e apresentar os pratos mais esquisitos.

## Cacerola BLACK

Faitout  
Bratentopf  
Casserole  
Çaçarola

	Ref	€	Ø (cm)	h (cm)	ml	U.Venta
<b>A</b>	63390	4,40	9	4,5	150	1
<b>B</b>	63391	11,80	18x8,5	5,0	480	1
<b>C</b>	63392	11,10	10	4,5	210	1
	63393	20,10	14	6,5	640	1



## Cacerola RED

Faitout  
Bratentopf  
Casserole  
Çaçarola

	Ref	€	Ø (cm)	h (cm)	ml	U.Venta
<b>A</b>	63394	4,40	9	4,5	150	1
<b>B</b>	63395	11,80	18x8,5	5,0	480	1
<b>C</b>	63396	11,10	10	4,5	210	1
	63397	20,10	14	6,5	640	1



## Cacerola GREY

Faitout  
Bratentopf  
Casserole  
Çaçarola

	Ref	€	Ø (cm)	h (cm)	ml	U.Venta
<b>A</b>	63398	4,40	9	4,5	150	1
<b>B</b>	63399	11,80	18x8,5	5,0	480	1
<b>C</b>	63400	11,10	10	4,5	210	1
	63401	20,10	14	6,5	640	1



# Colección PRESENTACIÓN

Inox



Dishwasher

**NO VÁLIDOS PARA FREIR**  
NOT valid for frying



- Fabricados en acero inoxidable de gran calidad (cestillos y cubos).
- Una forma elegante y original de servir todo tipo de aperitivos y tapas en bares, cafeterías, restaurantes o catering.
- Permiten colocar los alimentos sobre papel absorbente o bien directamente sobre el cestillo.

- Fabriquées en acier inoxydable de la plus grande qualité (paniers et cubes).
- Une façon élégante et originale de servir toutes sortes d'apéritifs et de tapas dans les bars, cafés, restaurants ou traiteurs.
- Permet de déposer les aliments sur du papier absorbant ou directement sur le panier.

- Made of top quality stainless steel (baskets and cubes).
- An elegant and original way of serving all kinds of snacks and tapas in cafes, restaurants or catering.
- Can be presented on absorbent paper or directly on the rack.

**Presentación sobre papel absorbente o directamente sobre el cestillo**

Can be presented on absorbent paper or directly on the rack



A

B

C



## Mini cubo

Mini-cube  
Mini-Eimer  
Mini cube  
Mini cubo

	Ref	€	Ø (cm)	h (cm)	ml	U.Venta
A	61107	4,80	7	7,0	200	12
B	61109	5,70	9	9,0	340	1
C	61112	7,40	12	12,0	900	1



new

A Inox



Dishwasher

B Bronce

C Black

## Cestillo redondo

Panier rond  
Korb, Rund  
Round basket  
Cesta redonda

	Ref	€	Ø (cm)	h (cm)	U.Venta
A	61009	8,70	9	8,0	6
B	61069	8,70	9	8,0	6
C	61150	8,50	9	8,0	6



## Cestillo cuadrado

Panier carré  
Korb, quadratisch  
Square basket  
Cesta quadrada

	Ref	€	cm	h (cm)	U.Venta
A	61007	8,70	10x8	7,0	6
	61052	11,20	12x10	9,0	6
B	61067	8,70	10x8	7,0	6
	61062	11,20	12x10	9,0	6
	61151	8,50	10x8	7,0	6
C	61152	10,90	12x10	9,0	6



## Cestillo cónico

Panier conique  
Korb, Konisch  
Conical basket  
Cesta cónica

	Ref	€	Ø (cm)	h (cm)	U.Venta
A	61053	9,60	12	10,0	6
B	61063	9,60	12	10,0	6
C	61153	9,30	12	10,0	6



## Cestillo rectangular

Panier rectangulaire  
Korb, rechteckig  
Rectangular basket  
Cesta rectangular

	Ref	€	cm	h (cm)	U.Venta
A	61056	13,00	21x11	6,0	1
B	61066	13,00	21x11	6,0	1
C	61155	12,60	21x11	6,0	1



## Cestillo rectangular con asas

Panier rectangulaire a/poignées  
Korb, rechteckig mit Griffen  
Rectangular basket with handles  
Cesta rectangular com alças

	Ref	€	cm	h (cm)	U.Venta
A	61055	13,00	21x11	6,0	1
B	61065	13,00	21x11	6,0	1
C	61154	12,60	21x11	6,0	1



## Abedul

Birch wood

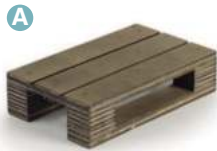

### Resistente y duradero

Strong and long-lasting



### Madera de abedul 100% natural

Made of 100% natural birch wood



## Mini palet presentación

Mini palette de présentation  
Minipalette für Präsentation  
Mini pallet for presentation  
Mini palete de apresentação

	Ref	€	cm	h (cm)	U.Venta
A	61060	6,50	13x8	3,0	1
B	61059	8,70	20x12	3,0	1
C	61058	11,60	30x20	3,0	1
D	61057	13,30	40x15	3,0	1



FE



Hierro/iron Dishwasher

## Paellera esmaltada SMALT

Plat à paella  
Paellapfanne, emailiert  
Round dish for paella  
Paelheira esmaltada

	Ref	€	Ø (cm)	U.Venta
	60170	5,10	10	10
	60172	5,70	12	10
	60175	6,70	15	6
	60180	8,60	20	6



Esmalte vitrificado  
Vitrified enamel

FE



Hierro/iron Dishwasher

## Cacerola esmaltada

Faitout à paella  
Bratentopf, emailiert  
Casserole  
Caçarola esmaltada

	Ref	€	Ø (cm)	h (cm)	U.Venta
	60192	6,50	12	4,0	1
	60196	7,70	16	4,5	1
	60190	8,50	20	4,7	1



Esmalte vitrificado  
Vitrified enamel

new



# Tablas **CRISTAL / PIZARRA & BAMBÚ**



## Pizarra y bambú 100% natural 100% natural slate and bamboo

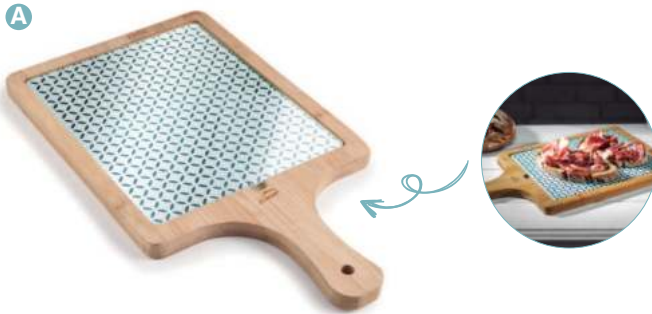

- Fabricada en bambú natural robusta y muy resistente.
- Tabla con mango con una base extraíble ideal para presentar y servir.
- Pestaña para facilitar la extracción del cristal/pizarra.
- Se aconseja su lavado a mano.

- Fabriquée en bambou naturel, robuste et très résistante.
- Planche avec manche et dotée d'une base extractible, idéale pour présenter et servir.
- Possède une encoche pour une meilleure extraction de verre/ardoise.
- Il est conseillé de la laver à la main.

- Aus natürlichem Bambusholz gefertigt, sehr stabil und strapazierfähig.
- Brett mit Griff und entnehmbarer Unterlage, ideal zum Anrichten und Servieren.
- Rand hilft beim Entnehmen der Platte.
- Am besten von Hand reinigen.

- Made of strong and highly durable natural bamboo.
- Cutting board with a handle and a removable base perfect for presenting and serving.
- Tab for removing the glass/ slate.
- Washing by hand recommended.

- Fabricada em bambu natural, robusta e resistente.
- Tábua com mango e base, extraível, ideal para apresentar e servir.
- Pestana para facilitar a extração da vidro/ ardósia.
- Recomenda-se lavar à mão.

### Tabla cristal & bambú

Planche verre & bambou  
Glas & bambusbrett  
Glass & bamboo board  
Tábua vidro & bambu

	Ref	€	Tabla con mango (cm)	Cristal (cm)	U.Venta
A	61048	12,60	38,5x21,5x1,5	28x18,5	1
B	61049	13,10	38,5x27,5x1,5	Ø24,5	1



### Tabla pizarra & bambú

Planche ardoise & bambou  
Schiefer & bambusbrett  
Slate & bamboo board  
Tábua ardósia & bambu



### Tabla pizarra & bambú

Planche ardoise & bambou  
Schiefer & bambusbrett  
Slate & bamboo board  
Tábua ardósia & bambu

	Ref	€	Tabla con mango (cm)	Pizarra (cm)	U.Venta
	61045	7,30	40x10x1,5	25x7,5	1

	Ref	€	Tabla con mango (cm)	Pizarra (cm)	U.Venta
	61046	14,60	50x18x1,5	35x15	4



### Tabla redonda pizarra & bambú

Planche rond ardoise & bambou  
Schiefer & bambusbrett  
Round slate & bamboo board  
Tábua redonda ardósia & bambu

	Ref	€	Tabla con mango (cm)	Pizarra Ø (cm)	U.Venta
	61047	19,70	38,5x28x1,5	25	12



### Tabla pizarra & bambú

Planche ardoise & bambou  
Schiefer & bambusbrett  
Slate & bamboo board  
Tábua ardósia & bambu

Incluye  
3 cuencos cerámicos para salsas  
Includes 3 ceramic bowls for sauces

	Ref	€	Tabla (cm)	Pizarra (cm)	Cuenco (cm)	ml	U.Venta
	61042	18,40	28x28x1,5	25x15	8,5x8,5x3	56	1

# Colección ALIÑO

Inox  
18/10



**REGULADOR: SISTEMA PATENTADO: con dispositivo antigoteo para dosificar la cantidad a verter.**

RÉGULATEUR: SYSTÈME BREVETÉ: Mini d'un dispositif antigouttes et régulateur pouvant doser la quantité à verser.

REGLER: PATENTIERTES SYSTEM: Mit antitropfvorrichtung und Dosierregler.

REGULATOR: PATENTED SYSTEM: With anti-drip device and regulator for controlling the amount to be poured.

REGULADOR: SISTEMA PATENTEADO: Com dispositivo anti-gota e regulador para dosificar a quantidade a verte.

Luxe

## Juego vinagrera 4 piezas con soporte

Set vinaigriees 4 pièces socle rond  
Essig/Öl-Set, 4-tlg, rund  
Cruet set 4 pcs.  
Jogo galheteiro 4 peças com suporte

Ref	€	ml	U.Venta
62464	49,20	170-30	1



## Juego aceitera-vinagrera c/soporte

Set huilier et vinaigrier sur socle rond  
Öl-Essig-Set  
Oil-vinegar set  
Jogo azeiteira-galheteiro com suporte

Ref	€	ml	U.Venta
62462	34,50	170	1



## Palillero redondo

Porte cure dents rond  
Zahnstocherbüchse, rund  
Round toothpick holder  
Paliteiro redondo

Ref	€	ml	U.Venta
62470	4,20	30	1



## Juego salero-pimentero c/soporte

Set sel-poivre sur socle rond sur socle carré  
Salz-/Pfefferstreuer, rund  
Salt & pepper cruet set  
Jogo saleiro e pimenteiro com suporte

Ref	€	ml	U.Venta
62466	23,00	30	1



Hiperlux

## Juego vinagrera 4 piezas con soporte

Set vinaigriees 4 pièces socle carré  
Essig/Öl-Set, 4-tlg, viereckig  
Cruet set 4 pc.  
Jogo galheteiro 4 peças com suporte

Ref	€	ml	U.Venta
62465	51,00	200-35	1



## Juego aceitera-vinagrera con soporte

Set huilier et vinaigrier sur socle rond  
Öl-Essig-Set  
Oil-vinegar set  
Jogo azeiteira-galheteiro com suporte

Ref	€	ml	U.Venta
62463	36,00	200	1



## Juego salero-pimentero con soporte

Set sel et poivre sur socle carré  
Salz-/Pfefferstreuer, viereckig  
Salt & pepper cruet set  
Jogo saleiro e pimenteiro com suporte

Ref	€	ml	U.Venta
62461	25,70	35	1



Basic

Inox

### Juego vinagrera

Set vinaigrie  
Menage  
Cruet set  
Jogo galheteiro

Ref	€	ml	U.Venta
62864	13,90	175-37,5	1



### Juego aceitera-vinagrera

Set huilier et vinaigries  
Öl-Essig-Set  
Oil-vinegar set  
Jogo azeiteira-galheteiro

Ref	€	ml	U.Venta
62862	11,10	175	1



### Juego salero-pimentero

Set callière et poivriere  
Satz-Pfeffer-Set  
Salt-pepper set  
Jogo saleiro-pimenteiro

Ref	€	ml	U.Venta
62866	5,70	37,5	6



### Jgo. salero-pimentero-mostaza

Set 3 pièces sel poivre moutarde  
Satz/Pfeffer/Senf-Set  
Salt-pepper-mustard set  
Saleiro-pimenteiro-mostarda set

Ref	€	ml	U.Venta
62867	9,20	37,5-150	1



Inox  
18/10

### Aceitera cónica

Huilier  
Ölkanne  
Oil can  
Azeiteira cónica

Ref	€	L	h (cm)	U.Venta
62525	28,00	0,25	10,0	1
62555	41,10	0,50	19,0	1
62551	50,50	1,00	23,0	1



### Dosificador-medidor de aceite

Doseur distributeur à huile  
Öl-Dosierer mit Massanzeige  
Oil portionner-measurer  
Distribuidor-manómetro de óleo

Ref	€	Ø (cm)	ml	U.Venta
62252	22,10	7,8x23	250	1



PC

Polycarbon



### Pulverizador de aceite

Pulvérisateur d'huile  
Öl-Spray  
Oil Sprayer  
Pulverizador de azeite

Ref	€	Ø (cm)	ml	U.Venta
61908	15,40	7x18	100	1



ASA

Acrylic



### Pulverizador de aceite-vinagre

Pulvérisateur d'huile et vinaigries  
Öl-Essig Spray  
Oil-vinager bottle spray  
Pulverizador de azeite-galheteiro

Ref	€	Ø (cm)	ml	U.Venta
61921	16,10	5,5x20	200	1



PS

Plastic



### Jarra separadora grasas

Separateur de graisse  
Fettabscheider  
Gravy/fat separator  
Separador de gorduras

Ref	€	ml	Unidades	U.Venta
61610	7,10	500	ml-oz-cup	4



Filtro resistente al calor

Heat-resitant filter

# Especieros INOX · PLASTIC

Inox



Capacidad · Capacity: 300 g

PMMA

PP

Inox  
18/10



Capacidad · Capacity: 100 g

## Especiero agujeros peq.

Saupoudreuse à figures, fines  
Gewürzdose/Streuer, Lochung Klein  
Small shaker plastic cover hole lid  
Polvilhador burucos pequeno

Ref	€	Ø (cm)	h (cm)	U.Venta
62906	8,70	7	9,50	12



## Especiero agujeros grandes

Saupoudreuse à figures, grosses  
Gewürzdose/Streuer, Lochung Gross  
Large shaker plastic cover hole lid  
Polvilhador burucos grandes

Ref	€	Ø (cm)	h (cm)	U.Venta
62905	8,70	7	9,50	12



## Especiero queso rayado

Saupoudreuse à fromage  
Käsestreuert  
Cheese shaker  
Polvilhadoqueijo ralado

Ref	€	Ø (cm)	h (cm)	U.Venta
62904	8,50	7	9,50	12



## Especiero malla fina

Saupoudreuse à maille  
Gewürzdose/Streuer-Fein  
Shaker plastic cover fine mesh lid  
Polvilhador rede fina

Ref	€	Ø (cm)	h (cm)	U.Venta
62903	9,20	7	9,50	12



## Pimentero

Poivrière  
Pfefferstreuer  
Pepper shaker  
Pimenteiro

Ref	€	Ø (cm)	h (cm)	U.Venta
61903	10,60	7	12,5	1



## Especiero queso rayado

Saupoudreuse à fromage  
Käsestreuert  
Cheese shaker  
Polvilhadoqueijo ralado

Ref	€	Ø (cm)	h (cm)	U.Venta
61905	10,60	7	12,5	1



## Salero

Salière  
Salzstreuet  
Salt shaker  
Saleiro

Ref	€	Ø (cm)	h (cm)	U.Venta
61907	10,70	7	12,5	1



## Azucarero

Saupoudreuse à sucre  
Zuckerstreuert  
Sugar shaker  
Acucareiro

Ref	€	Ø (cm)	h (cm)	U.Venta
61904	12,00	7	12,5	1



## Especiero malla

Saupoudreuse à maille fine  
Mehlstreuer  
Mesh shaker  
Polvilhador rede

Ref	€	Ø (cm)	h (cm)	U.Venta
61906	11,30	7	12,5	1



## Dispensador miel

Distributeur de miel  
Honigbehälter  
Honey dispenser  
Dosificador mel

Ref	€	Ø (cm)	h (cm)	U.Venta
61909	14,00	7	12,5	1



# Colección MOLINILLOS



- Muele al instante. Muelas: no pierden filo y no se oxidan.
- Molido a baja velocidad: conserva mejor las propiedades y aromas.
- Funcionamiento sencillo. Muy fácil de limpiar.

- Moud à l'instant. Meules : pas d'usure du fil et pas d'oxydation.
- Mouture à faible vitesse : meilleure conservation des propriétés et des arômes.
- Fonctionnement simple. Très facile à nettoyer.

- Mahlt sofort. Mahlwerk: verliert nicht an Schriff und rostet nicht.
- Langsame Vermahlung: Eigenschaften und Aromen bleiben besser erhalten.
- Einfache Funktionsweise. Sehr einfach zu reinigen.

- Grinds instantly. Burrs don't get dull or rusty.
- Low speed grind conserves coffee properties and aromas better.
- Easy to use. Very easy to clean.

- Mói instantaneamente. Mós, que não perdem o fio e não se oxidam.
- Moagem a baixa velocidade, que conserva melhor as propriedades e os aromas do produto.
- Funcionamento simple. Muito fácil de limpar.

**Inox**  
**18/10**

**Cristal**  
Glass

**Muelas cerámicas**  
Ceramic burrs

## Molinillo manual

Moulin manuel  
Manuelle Mühle  
Manual grinder  
Moinho manual



**8 niveles de grosor**  
8 grinding levels

Ref	€	g	h (cm)	U.Venta
62817	33,20	45	21	1

## HAYA

Wood

**Mecanismo de acero templado**  
Hardened steel mechanism

## Molinillo de pimienta

Moulin à Poivre  
Pfeffermühle  
Pepper Grinder  
Moinho de pimenta em madeira



Ref	€	Ø (cm)	h (cm)	U.Venta
63215	26,70	5,0	15	1
63220	31,30	5,5	20	1
63225	37,20	6,0	25	1

**Antideslizante en la parte superior e inferior**  
Non-slip upper and lower part

**Mecanismo cerámico**  
Ceramic mechanism

## ASA

Acrylic

## Molinillo doble sal - pimienta

Moulin double à sel - poivre  
Salz und Pfeffermühler Doppelt  
Salt - pepper double grinder  
Moinho duplo de sal - pimenta



Ref	€	Ø (cm)	h (cm)	g	U.Venta
62816	19,50	6	18	90	1

## ASA

Acrylic

## Molinillo de sal - pimienta

Moulin à sel - poivre  
Pfeffer / Salzmühle  
Salt - pepper Grinder  
Moinho de sal - pimenta

**Mecanismo cerámico**  
Ceramic mechanism



Ref	€	h (cm)	U.Venta
62814	23,50	14	6
62818	24,40	18	6
62823	26,40	23	6

Inox

## Molinillo DUAL eléctrico sal - pimienta

Moulin DUAL électrique à sel - poivre  
Elektrische Satz-/Pfeffermühle, DUAL  
DUAL salt - pepper electric grinder  
Moinho DUAL eléctrico sal - pimienta

Ref	€	Ø (cm)	h (cm)	U.Venta
62824	21,30	7	18	1

6 pilas de 1,5 V AAA  
(NO incluidas)

6 x 1.5V AAA batteries  
(Not included)

Mecanismo cerámico  
Ceramic mechanism

Pulsadores independientes

Independent switch

Compartimientos independientes

Independent compartments



Ideal para moler  
café, semillas, frutos secos, etc.

Perfect for grinding coffee, seeds,  
nuts, etc.

Depósito para 60 g de  
granos de café molido

Container for 60 g  
of ground coffee

Cuchillas de acero inoxidable  
de gran resistencia

High strength st. steel blades



- Ideal para moler café y otros productos como semillas, hierbas, frutos secos, cereales, sal, pimienta o especias.
- 100% acero inoxidable: cuerpo y cuchillas fabricados en acero inoxidable de máxima calidad.
- Tapa transparente: tapa superior de color transparente para visualizar el grano molido.
- Interruptor ON/OFF: funcionamiento con un simple botón (inicio/parada).
- Interruptor de seguridad: las cuchillas se activan solo cuando la tapa está correctamente cerrada.
- Depósito para 60 g de granos de café molido.
- Almacenamiento para el cable.
- Libre de BPA.

- Idéal pour mouler le café et d'autres produits tels que les graines, les herbes, les fruits secs, les céréales, le sel, le poivre ou les épices.
- 100% acier inoxydable : Corps et lames fabriqués en acier inoxydable de la plus grande qualité.
- Couvercle transparent : Couvercle supérieur de couleur transparente pour visualiser le grain moulu.
- Interrupteur ON/OFF : Fonctionnement avec un simple bouton (marche/arrêt).
- Interrupteur de sécurité : Les lames se mettent en marche uniquement lorsque le couvercle est correctement fermé.
- Réservoir pour 60 g de grains de café moulu.
- Rangement pour le câble.
- Sans bisphénol A.

- Perfect for grinding coffee or other products like seeds, herbs, nuts, grains, salt, pepper or spices.
- 100% Stainless Steel: Body and blades made of top quality stainless steel.
- Transparent Lid: Transparent upper lid so you can see the ground product.
- ON/OFF Button: Works with a simple button (start/stop).
- Safety Switch: The blades are only activated when the lid is properly closed.
- Container for 60 g of ground coffee.
- Storage for the cord.
- BPA Free.

Inox

## Molinillo LIMU

Moulin électrique  
Elektrische Mühle  
Electric grinder  
Moinho elétrico

Ref	€	U.Venta
69385	37,20	1



Ref	Tensión/Voltage	Potencia/Power	Capacidad/Capacity	Dimensiones/Sizes	Peso/Weight
69385	220-240 V / 50-60 Hz	200 W	60 g (9 cups)	Ø10x18 cm	780 g

# Servicio MESA

Inox  
18/10



Dishwasher

## Sopera con base

Soupiere sur pied  
Suppenschüssel mit Fussreif  
Soup-tureen with base  
Sopeira com base



Ref	€	Ø (cm)	L	U.Venta
60823	31,90	22	2,00	1
60825	34,10	24	2,50	1
60829	42,00	28	4,00	1

## Tapa sopera

Couvercle soupiere  
Deckel für Servierschüssel  
Soup-tureen lid  
Tampa sopeira



Ref	€	Ø (cm)	U.Venta
60922	20,20	22	1
60924	22,40	24	1
60928	26,30	28	1

## Legumbrera

Legumiere  
Servierschüssel  
Vegetable dish  
Legumeira



Ref	€	Ø (cm)	L	U.Venta
60812	24,80	22	2,0	1
60814	27,80	24	3,0	1
60818	36,60	28	4,5	1

Inox



## 6 boles pequeños

6 petit bols  
6 Schüssel, klein  
Vegetable bowls set of 6  
6 bacias pequenas mesa Service



Ref	€	Ø (cm)	ml	U.Venta
14012	11,30	12	325	1

ASA

Acrylic



## Ensaladera redonda

Saladier ronde  
Salatschüssel, rund  
Round salad bowl  
Bacia de salada redonda

Ref	€	Ø (cm)	L	U.Venta
62394	12,40	25	4,0	1

## Salsera LUXE con cuchara

Sauciere "Luxe"  
Sauciere Luxe  
Gravy boat "Luxe"  
Molheira "LUXE" com colher



Ref	€	ml	U.Venta
62424	23,70	200	1

## Salsera ALADINO

Sauciere "Aladino"  
Sauciere "Aladino"  
Gravy boat "Aladino"  
Molheira "Aladino"



Ref	€	cm	ml	U.Venta
61409	9,50	13x6x8	90	1
61415	11,40	15,5x7,2x10	150	1
61424	15,40	19x8,5x12,5	240	1
61430	16,50	20x9,5x12,5	300	1

## Quesera parmesana con cuchara

Boite à fromage a/cuillere  
Parmesanmenage mit Löffel  
Parmesan bowl with spoon  
Quejeira parmesana com colher



Ref	€	Ø (cm)	ml	U.Venta
62970	31,30	9x5	200	1
62971	4,10		200	18

Recipiente de cristal

Área útil de la base:  
Base useful area:  
15x10,5 cm



new

Vidrio borosilicato  
Borosilicate glass



Bambú natural 100%  
100% natural bamboo

## Recipiente de mantequilla

Récipiente pour le beurre  
Butterdose  
Butter container  
Recipiente para manteiga

Ref	€	cm	h (cm)	U.Venta
62898	9,80	18,5x14	6,5	1

- Mantiene la mantequilla fresca durante más tiempo preservando las propiedades, aroma y color.
- Ideal para servir directamente la mantequilla en la mesa.
- Multifuncional, ideal para mantequilla, pastas, galletas, frutos secos, etc.

- Maintient le beurre frais plus longtemps en préservant ses propriétés, son odeur et sa couleur.
- Idéal pour servir directement le beurre à table.
- Multifonctionnel, idéal pour le beurre, les biscuits, les fruits secs, etc.

- Butter bleibt länger frisch und behält Konsistenz, Aroma und Farbe.
- Ideal zum Servieren von Butter auf dem Tisch.
- Vielseitig verwendbar, ideal für Butter, Pasta, Kekse, Dörrobst usw.

- It keeps butter fresh longer and preserve its aroma and colour.
- It's perfect for serving butter on the table.
- Multifunctional, ideal for butter, pasta, cookies, nuts, etc.

- Mantém a manteiga fresca durante mais tempo, preservando as suas propriedades, aroma e cor.
- Ideal para servir a manteiga diretamente na mesa.
- Multifuncional, ideal para manteiga, doces, bolachas, frutos secos, etc.



Tapa de madera de caucho  
Rubber wood lid



## Recipiente de mantequilla

Récipiente pour le beurre  
Butterdose  
Butter container  
Recipiente para manteiga

Ref	€	cm	h (cm)	U.Venta
62899	15,00	16,5x11,5	6,5	1

## Fuente de mantequilla

Beurrier avec couvercle  
Butterdose mit Deckel  
Butter dish with cover  
Manteigueira



Ref	€	cm	h (cm)	U.Venta
62951	14,00	11,5x22,5	6,5	1

Protege los alimentos de los factores externos  
Protects food from external factors

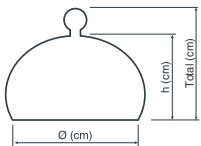

## Campana cubreplatos

Cloche couvre plat  
Teller-glocke  
Plate Cover  
Campânula cobre-pratos

Ref	€	Ø (cm)	h (cm)	Total (cm)	U.Venta
61806	39,40	25	14,0	18,5	1
61809	45,10	29	15,0	20,3	1
61802	48,80	33	17,0	22,3	1

- Fabricada en vidrio borosilicato de gran calidad y resistente a golpes, altas y bajas temperaturas.
- Protege los alimentos de los factores externos.
- Ideal tanto para conservar como para presentar galletas, bollería, quesos y todo tipo de alimentos.
- Se puede introducir en el microondas, horno y congelador.

- Fabriquée en verre borosilicate de grande qualité et résistante aux chocs ainsi qu'aux basses et hautes températures.
- Protège les aliments des agents externes.
- Idéale aussi bien pour conserver que pour présenter des gâteaux, des viennoiseries, des fromages et tout type d'aliments.
- Peut être mise au micro-ondes, au four ou au congélateur.

- Made of high quality impact resistant borosilicate glass that can withstand high and low temperatures.
- Protects food from external factors.
- Perfect for preserving and presenting biscuits, pastries, cheese or any other kind of food.
- Microwave, oven and freezer safe.

Protege los alimentos de los factores externos  
Protects food from external factors



## Cubreplatos

Cloches  
Tellerabdeckung  
Plate cover  
Cloche para pratos

Ref	€	Ø (cm)	h (cm)	U.Venta
69024	25,60	24	11,0	1
69029	38,40	28	17,5	1

ASA

Acrylic



## Cubre quesos / tartas

Couvre fromage/gâteau  
Tellerabdeckung  
Cheese/cake cover  
Cloque para queijo/tartes

Ref	€	Ø (cm)	U.Venta
62380	53,60	32	1





Acacia	AS	TPR	
Wood	plastic	plastic	

### Quesera

Plateau à fromage avec cloche  
Käseglocke  
Cheese dome  
Queijeira

Ref	€	U.Venta
62404	29,00	1



- Compuesta por base de madera de acacia natural y tapa de plástico opaca, libre de BPA.
- Antideslizante: base con aro de goma flexible que garantiza la máxima estabilidad.
- Diseñado para presentar y conservar tanto quesos como otros alimentos.

- Composé d'une base en acacia naturel et d'un couvercle en plastique opaque, sans BPA.
- Antidérapante : base avec cercle en caoutchouc flexible qui garantit une stabilité maximale.
- Conçue pour présenter et conserver aussi bien le fromage que d'autres aliments.

- Consists of a natural acacia wood base and a transparent plastic cover, BPA free.
- Non-slip: The base with a flexible rubber ring guarantees maximum stability.
- Designed for presenting and conserving cheese and other kinds of food.



### Azucarero sobremesa

Sucrier de table sphérique  
Zuckerdose, Kugelförmig  
Spherical table sugar bowl  
Açucareiro de mesa esférico

Ref	€	Ø (cm)	ml	U.Venta
63304	16,90	14	600	1



### Soporte menú con pinza

Support menu á pince  
Menükartenhalter  
Menu card holder  
Suporte menú com pinça

Ref	€	h (cm)	U.Venta
61008	12,90	20,0	1
61012	14,40	30,0	1



Inox

### Pinza sujeta manteles (4 pcs.)

Pince à nappe  
Tischtuchklammer  
Tablecloths pegs  
Pinça para toalhas de mesa

Ref	€	U.Venta
61023	6,90	6



Inox

### Indicador reservado

Indicateur réservée  
Reserviert-Aufsteller  
Reserved signal  
Indicador reservado

Ref	€	cm	U.Venta
61098	4,30	5x12	6



Inox

### Números de mesa

Numéros de table  
Tischnummernschild  
Table numbers  
Números para tabela

Ref	€	cm	Números	U.Venta
61095	20,00	6x5	1-12	1
61096	20,00	6x5	13-24	1
61097	19,90	6x5	25-36	1



### Servilletero

Distributeur de serviettes  
Serviettenspender  
Napkin holder  
Guardanapo

Ref	€	cm	h (cm)	U.Venta
61004	13,50	18x19	5,0	1



Inox

### Servilletero bar

Distributeur de serviettes bar  
Serviettenspender bar  
Bar napkin holder  
Guardanapo bar

	Ref	€	cm	Servilleta	U.Venta
A	61001	13,20	8,5x12,0	90x125	1
B	61002	9,40	9,5x13,5	90x125	4

## Papelerera sobremesa

Poubelle de table  
Tish-Abfallbehälter  
Table bin  
Papeleira de mesa



Ref	€	Ø (cm)	L	U.Venta
63302	24,10	12x16	1,20	1

Inox

## Cepillo recogemigas

Ramasse-miettes à rouleaux  
Krümelbürste  
Crumbs cleaner  
Escova apanha-migalhas



Ref	€	cm	h (cm)	U.Venta
64407	14,70	9,5x16,5	4,0	1

## Cepillo recogedor HIPERLUXE

Ramasse-miettes à rouleaux HIPERLUXE  
Krümelbürste, HIPERLUXE  
HIPERLUXE crumbs cleaner  
Escova apanha-migalhas HIPERLUXE



Ref	€	cm	U.Venta
64408	49,70	14,5x17	1

## Cepillo recogedor LUXE

Ramasse-miettes LUXE  
Krümelbürste, LUXE  
LUXE crumbs cleaner  
Espátula apanha-migalhas LUXE



Ref	€	cm	U.Venta
64409	30,90	22x7	1



## Bandeja con pinza para notas

Porte addition à pince  
Platte mit Klemmvorrichtung  
Bill holder  
Bandeja com pinça para notas

	Ref	€	cm	U.Venta
A	68007	5,30	11x15,2	12
B	68017	6,20	12x21,5	12

PP ABS

Polypropylene Plastic Stackable



## Bandeja cambios COIN

Coupelle ramasse monnaie.  
Wechselgeldablagen  
Changetray  
Bandeja para trocos

Ref	€	Ø (cm)	U.Venta
68720	3,10	13	12

Inox

## Campanilla de recepción

Sonnette de réception  
Rezeptionsklingel  
Reception call bell  
Campainha de receção



Ref	€	Ø (cm)	U.Venta
61025	11,30	10	1

## Cenicero

Cendrier  
Aschenbecher  
Ashtray  
Cinzeiro



	Ref	€	Ø (cm)	U.Venta	
A	14013	2,70	14	12	Redondo · Round
A	14065	3,10	16	12	Redondo · Round
B	62941	6,20	14	1	Cuadrado · Square

# Encendedores de GAS



Caña flexible  
Flexible rod



## Encendedor de gas

Allume-gaz à flamme  
Gasanzünder  
Gas lighter  
Isqueiro de gás

	Ref	€	Cant.	U.Venta
A	68976	36,80	12	1
B	68977	47,20	12	1

- Encendido con gatillo. Regulador de llama.
- Recargable.
- Sistema de bloque de seguridad.

- Allumage avec gâchette. Régulateur de flamme.
- Rechargeable.
- Système de sécurité par blocage.

- Entzündet auf Knopfdruck. Flammenregler.
- Wieder aufladbar.
- Sicherheitssperre.

- Trigger lighter. Flame regulator.
- Rechargeable.
- Safety lock system.

- Com gatilho para acender. Regulador de chama.
- Recarregável.
- Sistema de bloqueio de segurança.

## Encendedor de gas

Allume-gaz à flamme  
Gasanzünder  
Gas lighter  
Isqueiro de gás

	Ref	€	L (cm)	U.Venta
A	68987	4,00	27	6
B	68978	3,50	27	12
C	68979	4,30	27	12

A



B



C



Caña flexible  
Flexible rod

# Gel COMBUSTIBLE

- Gel de origen orgánico. No produce emanaciones tóxicas.
- Encendido rápido y combustión silenciosa, limpia, inodora, sin humos y sin cenizas.

- Gel d'origine biologique. Ne produit pas de fumées toxiques.
- Allumage rapide et combustion silencieuse, propre, sans odeur, sans fumée et sans cendres.

- Gel organischen Ursprungs. Erzeugt keine giftigen Dämpfe.
- Schnelle Zündung und leise, saubere, geruchlose, rauch- und aschefreie Verbrennung.

- Organic gel fuel. Does not produce toxic fumes.
- Quick-lighting and quiet-burning, clean, odourless, smokeless and ash-free.

- Gel de origem orgânica. Não produz gases tóxicos.
- Ignição rápida e combustão silenciosa, limpa, inodora, sem fumo e sem cinzas.

Inox

## Contenedor de combustible

Porte-brûleur  
Brennpasten-Behälter  
Burner holder  
Recipiente de combustível



Ref	€	Ø (cm)	h (cm)	L (cm)	Asa	U.Venta
69006	23,90	9,0	6,0	7,0		1



## Gel combustible ETANOL

Gel chauffe ETHANOL  
Brennpaste, ETHYALKOHOL  
Fuel gel, ETHANOL  
Gel combustível ETANOL



B



C



D



	Ref	€	Kg	Horas	U.Venta
A	71780	4,80	0,08	80 min	1 <b>Set 3 latas · 3 can set</b>
B	69108	2,70	0,225	3	72 <b>Lata · Can</b>
C	69107	8,60	0,840	-	1 <b>Botella · Bottle</b>
D	69109	39,40	4,00	-	1 <b>Bidón · Barrel</b>



# Pinzas

Tongs

# Colección PINZAS

Inox  
18/10

Inox

## Pinza servicio mesa

Pince à servir  
Servierzange  
Serving tong  
Pinça de serviço de mesa



Ref	€	L (cm)	U.Venta
62307	4,80	21	12

## Tenedor - cuchara servir

Pince à service  
Servierzange  
Utility tong  
Garfo e colher de servir



Ref	€	L (cm)	U.Venta
68009	9,90	24	6

## Cuchara pinza servir

Cuillère pince à service  
Servierlöffel, Zange  
Serving spoon tong  
Concha pinça de servir



Ref	€	L (cm)	U.Venta
62353	12,20	24	1

## Pinza hamburguesa

Pince inox pour hamburger  
Zange für Burgers  
Tongs for beef Burgers  
Pinça de hamburger



Ref	€	L (cm)	U.Venta
62318	11,90	24	12

## Pinza pasta LUXE

Pince à spaghetti Luxe  
Teigwaren Zange Luxe  
Pasta Tong Luxe  
Pinça massas Luxe



Ref	€	L (cm)	U.Venta
62981	10,10	20	1

## Pinza pasta

Pince à spaghetti  
Teigwaren-Zange  
Spaguetti Tong  
Pinça massas



Ref	€	L (cm)	U.Venta
62986	5,40	19	12

## Pinza pan

Pince à pain  
Brotzange  
Bread tong  
Pinça pão



Ref	€	L (cm)	U.Venta
62978	8,80	18	1

## Pinza pan

Pince à pain  
Brotzange  
Bread tong  
Pinça pão



Ref	€	L (cm)	U.Venta
62982	16,90	23	12

PS

Plastic



## Pinza ensalada

Pinces a salade  
Salatzange  
Salad scissor tong  
Pinça de salada



Ref	€	L (cm)	U.Venta
68021	4,80	28,5	12

ASA

Acrylic



## Tenedor + cuchara ensalada

Fourchette + cuillère a salade  
Gabel + Löffel Acryl  
Salad spoon + fork  
Garfo + colher de salada



Ref	€	L (cm)	U.Venta
62399	7,60	30	1

### Pinza repostería

Pince à gateau  
Gebäck-Tortenzange  
Cake tong  
Pinça pastelaria



Ref	€	L (cm)	U.Venta
62317	11,70	20	1

### Pinza repostería con anillas

Pince à gateau avec anneaux  
Gebäckzange  
Cake tong with rings  
Pinça pastelaria com anilhas



Ref	€	L (cm)	U.Venta
68008	5,90	16	6

### Pinza para bolsitas de té

Pince pour sachets de thé  
Teebeutelzange  
Tea bag tong  
Pinças para saquetas de chá



- Exprime fácilmente tu infusión sin riesgo de mancharte o quemarte.
- Diseñada para una extracción fácil y efectiva de la bolsa de té.
- Orificios para exprimir hasta la última gota.
- Mango de acero inoxidable para un agarre cómodo y seguro.

- Squeeze easily your infusion without the risk of leaving or burning yourself.
- Designed for easy and effective tea bag removal.
- Holes for squeezing out the last drop.
- Stainless steel handle for a comfortable and safe grip.

	Ref	€	L (cm)	U.Venta
A	68078	2,30	13,5	1
B	68079	3,50	14,0	1

Inox

### Pinza azucarillos

Pince à sucre  
Zucker-Zange  
Food tong  
Pinça p/cubos de açúcar



Ref	€	L (cm)	U.Venta
62985	3,70	11	6

### Pinza hielo

Pince à glace  
Eiszange  
Ice tong  
Pinça de gelo



Ref	€	L (cm)	U.Venta
62306	4,60	18,5	12

Inox

### Pinza hielo LUXE

Pince à glace Luxe  
Eiszange, Luxe  
Luxe Ice tong  
Pinça de gelo Luxe



Ref	€	L (cm)	U.Venta
62337	9,90	20	12

### Pinza multiusos LUXE

Pince multi-usages  
Allzweck Zange  
Multipurpose tong  
Pinça multiusos Luxe



Ref	€	L (cm)	U.Venta
62334	19,80	25	1

Inox

### Pinza multiusos

Pince multi-usages  
Allzweck-Zange  
Luxe tong  
Pinça multiusos



Ref	€	L (cm)	U.Venta
62984	3,80	16	5

### Pinza LUXE

Pince Luxe  
Zange Luxe  
Luxe tong  
Pinça Luxe



Ref	€	L (cm)	U.Venta
62983	15,30	30	12

Inox

## Pinza Jumbo

Pince de service  
Jumbo Zange  
Utility tong  
Pinça Jumbo



Ref	€	L (cm)	U.Venta
62924	5,70	24	12
62930	6,70	30	12
62940	7,90	40	12

Inox

PA

Nylon



## Pinza Jumbo nylon

Pince de service  
Jumbo Zange  
Utility tong  
Pinça Jumbo



Ref	€	L (cm)	U.Venta
62926	7,40	24	12
62929	8,60	30	12
62939	11,10	40	12

Inox

SI

Silicone



## Pinza Jumbo silicona

Pince de service  
Jumbo Zange  
Utility tong  
Pinça Jumbo



Ref	€	L (cm)	U.Venta
63926	7,40	24	12
63929	8,60	30	12
63939	11,10	40	12

new

· Mango revestido con una capa de aislante térmica para una mejor sujeción.

· Handle coated with a layer of thermal insulation and an enhanced grip.



## Pinzas KARU

Pinces  
Zanges  
Tongs  
Pinças



	Ref	€	L (cm)	Color	U.Venta	Ref	€	L (cm)
A	63060	7,30	24	Rojo · Red	12	63070	7,90	30
B	63061	7,30	24	Negro · Black	12	63071	7,90	30
C	63062	7,30	24	Azul · Blue	12	63072	7,90	30
D	63063	7,30	24	Amarillo · Yellow	12	63073	7,90	30
E	63064	7,30	24	Verde · Green	12	63074	7,90	30
F	63065	7,30	24	Marrón · Brown	12	63075	7,90	30

Inox

SI

Silicone



## Pinzas silicona (25 pcs.)

Pinces silicon  
Silikon Zanges  
Silicone tongs  
Pinças silicone



	Ref	€	L (cm)	Color	U.Venta
A	64434	67,50	18,0	Caja (25 pcs.) · Set (25 pcs.)	1
B	64432	2,90	18,0	Naranja · Orange	12
C	64433	2,90	18,0	Rojo · Red	12
D	64436	2,90	18,0	Azul · Blue	12
E	64437	2,90	18,0	Verde · Green	12
F	64439	2,90	18,0	Morada · Purple	12



### Pinza grill

Pince à grill  
Grilltongs  
Grill tong  
Pinça grelhador



Ref	€	L (cm)	U.Venta
62933	15,00	30	6



### Pinza larga silicona

Pince long en silicone  
Zange aus Silikon  
Long Silicone tong  
Pinça comprida silicone



Ref	€	L (cm)	U.Venta
62931	9,00	29	1

## Colección PINZAS DE PRECISIÓN

new



### Pinza de precisión recta

Pince de précision droite  
Präzisionszange glatt  
Straight precision tong  
Pinça de precisão reta



Ref	€	L (cm)	U.Venta
62955	5,30	15,5	1
62956	10,30	21,0	1

- Pinzas de precisión fabricada en acero inoxidable 18/10 de máxima calidad.
- Ideales para manipular y emplatar tus creaciones a la perfección.
- Mango antideslizante y puntas acanaladas para una sujeción 100% segura.
- Aptas para lavavajillas.

- Pincettes à dresser fabriquée en acier inoxydable 18/10 de la plus grande qualité.
- Idéales pour manipuler et dresser vos créations à la perfection.
- Manche antidérapant et pointes rainurées pour une adhésion 100% efficace.
- Apte pour le lave-vaisselle.

- Pinzettes aus nicht rostendem Edelstahl 18/10 bester Qualität.
- Ideales zum Verkosten und Anrichten flüssiger und fester Küchenkreationen.
- Rutschfester Griff und gerillte Enden für 100% sicheren Halt.
- Spülmaschinenfest.

- Precision tongs made of top quality 18/10 stainless steel.
- Perfects for presenting your creations with solid food.
- Non-slip handle and channelled tips for 100% secure holding.
- Dishwasher safe.

- Pinzas de precisão fabricada em aço inoxidável 18/10 de máxima qualidade.
- Ideales para emplatado as suas criações.
- Cabo antideslizante e pontas acanaladas para uma sujeição 100% segura.
- Apta para máquinas de lavar louça.

### Puntas curvas puntiagudas y rugosas

Curved tip pointed and rough



### Pinza de precisión acodada

Pince de précision  
Präzision zange  
Precision tong  
Pinça de precisão

Ref	€	L (cm)	U.Venta
62865	4,70	15,5	1

### Pinza de precisión con cuchara

Pince de précision avec cuillère  
Präzision zange mit Löffel  
Precision tong with spoon  
Pinça de precisão com colher

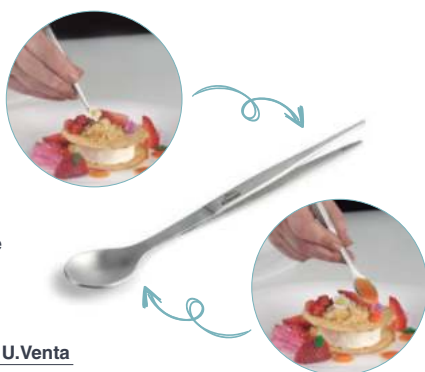

Ref	€	L (cm)	U.Venta
62863	5,80	17,0	1

### Pinza de precisión INOX

Pince de précision  
Präzision zange  
Precision tong  
Pinça de precisão

	Ref	€	L (cm)	U.Venta
A	62954	5,30	16	1
B	62821	6,20	21	1



### Acabado negro mate

Finish in matte black

### Pinza de precisión TITAN BLACK

Pince de précision  
Präzision zange  
Precision tong  
Pinça de precisão

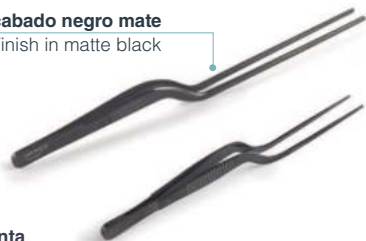

Ref	€	L (cm)	U.Venta
62872	5,90	21	1
62874	4,50	16	1

### Acabado iridiscente

Iridescent finish

### Pinza de precisión TITAN RAINBOW

Pince de précision  
Präzision zange  
Precision tong  
Pinça de precisão

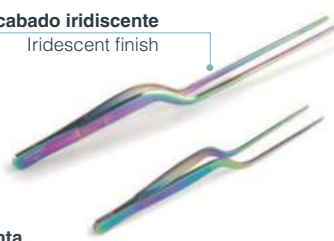

Ref	€	L (cm)	U.Venta
62873	5,90	21	1
62875	4,50	16	1





### Cuchara para miel

Cuillère à miel  
Honiglöffel aus Edelstahl  
St steel honey spoon  
Colher para mel

Ref	€	L (cm)	U.Venta
61361	10,60	16,5	1



### Zamak

Zinc Alloy

### Tenaza extractor huesos aceitunas

Dénoyauteur, Chromé  
Olivenentsteiner, Verchromt  
Zinc alloy live seed remover  
Tenaz extrator de ossos de azeitonas

Ref	€	L (cm)	U.Venta
62973	8,00	16	1



### Pinza para horno y bandeja GN

Pince inox pour bac Gastronorm  
Zange für GN Behälter  
Tong GN tray  
Pinça para forno e bandejas GN

Ref	€	L (cm)	U.Venta
62989	17,00	20	12



### SI 200°C

Silicone max

### Pinza con silicona para horno y bandeja

Pince Inox pour bac Gastronorm avec Silicone  
Zange für GN Behälter, mit Silikon  
Oven tray tong with Silicone  
Pinça para forno e bandejas com silicone

Ref	€	L (cm)	U.Venta
62998	17,00	20	12



### Zamak

Zinc Alloy

### Cascanueces

Casse Noix  
Nussknacker  
Nut Cracker  
Parte-nozes

Ref	€	U.Venta
63016	15,40	6



### Zamak

Zinc Alloy

### Cascanueces

Casse Noix  
Nussknacker  
Nut Cracker  
Parte-nozes

Ref	€	U.Venta
63017	19,30	6



### Inox

### Tenaza marisco

Pince à casse-homard  
Hummerzange  
Lobster cracker  
Tenaz mariscos

Ref	€	L (cm)	U.Venta
62908	15,50	16	12



### Inox

### Tijera - tenaza marisco

Pince casse homard  
Schere/Zange Meeresfrüchte  
Sea food scissor-tong  
Tesoura-tenaz marisco

Ref	€	L (cm)	U.Venta
62974	17,10	18,5	12



### Inox

### 6 pinchos para marisco

Ensemble 6 curettes à homard  
Hummergabel (6)  
6 Pcs. seafood forks  
6 espetos para marisco

Ref	€	L (cm)	U.Venta
62976	29,90	18,5	1



### Abre ostras LUXE

Couteau à huîtres LUXE  
Austermesser, LUXE  
LUXE oyster openne  
Aberto-ostras LUXE

Ref	€	L (cm)	U.Venta
62684	12,60	20	1



### Pinza quitaespinas

Pince à arêtes  
Grätenzange  
Fish-bone tweezers  
Pinça tira-espinhas



Ref	€	L (cm)	U.Venta
62938	4,70	8	1
62928	5,90	12	1

Inox

### Desescamador de pescado

Grattoir de poissons  
Fischschuppenentferner  
Fish scraper  
Raspador de peixe



Ref	€	L (cm)	U.Venta
39040	8,20	19	1



Las escamas se quedan atrapadas en la funda  
The scales get trapped in the cover

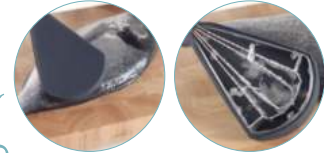

Doble hojas dentadas  
Double toothed slats

Doble hojas dentadas  
Double toothed slats

Funda de silicona  
Silicone cover



### Desescamador de pescado

Grattoir de poissons  
Fischschuppenentferner  
Fish scraper  
Raspador de peixe



### Desescamador de pescado

Grattoir de poissons  
Fischschuppenentferner  
Fish scraper  
Raspador de peixe



Ref	€	L (cm)	U.Venta
39041	11,80	27,5	1

Ref	€	Cabezal (cm)	L (cm)	U.Venta
39042	24,00	9x13,5	30	1
A R39042A	7,90	9x13,5	14	1

Funda silicona  
Silicone cover

# Colección BBQ

new

Inox



Dishwasher

## Tenedor

Fourchette  
Tranchiergabel  
Fork  
EGarfo

Ref	€	L (cm)	U.Venta
60261	5,10	43,5	1



## Cuchillo

Couteau  
Messer  
Knife  
Escova

Ref	€	L (cm)	U.Venta
60262	4,90	41,5	1



## Espátula

Spatule  
Schaufel  
Spatule  
Espátula

Ref	€	L (cm)	U.Venta
60263	8,10	45,5	1



## Brocha

Broche  
Bürstes  
Brush  
Escova

Ref	€	L (cm)	U.Venta
60264	6,10	44,0	1



## Espátula acodada

Spatule coudées  
Winkelpalette  
Bent spatule  
Espátula comprida

Ref	€	L (cm)	U.Venta
60266	5,80	28,0	1



- Práctico maletín de aluminio compuesto por 5 utensilios para barbacoa: espátula, tenedor, cuchillo, pinza dentada y brocha.
- Todas las piezas fabricadas en acero inoxidable de máxima calidad.
- Mango ergonómico, resistente al calor.
- Maletín rectangular portátil con el interior forrado.
- Completa el set con los accesorios adicionales: espátula acodada y cepillo de limpieza.

- Malette pratique en aluminium composée de 5 ustensiles pour barbecue : spatule, fourchette, couteau, pince dentée et broche.
- Toutes les pièces sont fabriquées en acier inoxydable de la plus grande qualité.
- Manche ergonomique, résistant à la chaleur.
- Mallette rectangulaire transportable avec revêtement intérieur.
- Complétez l'ensemble avec les accessoires supplémentaires : spatule coudée et brosse de nettoyage.

- Practical aluminium case with 5 barbecue utensils: spatula, fork, knife, serrated tongs and brush.
- All parts made of top-quality stainless steel.
- Ergonomic, heat-resistant handle.
- Portable rectangular case with lined interior.
- Complete the set with these additional accessories: angled spatula and cleaning brush.



## Maletín

Malette  
Koffer  
Briefcase  
Maleta

Ref	€	cm	U.Venta
60260	46,70	47x16,6x8	1

## Pinza

Pincs  
Zangs  
Tong  
Pinça

Ref	€	L (cm)	U.Venta
60265	9,90	43,5	1



ACCESORIOS · Accessoires · Zubehör · Accessories · Acessórios

## Cepillo de limpieza

Brosse de nettoyage  
Reinigungsbürste  
Cleaning brush  
Escova de limpeza

Ref	€	L (cm)	U.Venta
60267	6,80	45,0	1





# Cafetería

Coffe

# Colección MOLINILLOS DE CAFÉ

Inox



AC



**Selector de tazas de 1 a 12 tazas**  
Cup selector, 1 to 12 cups



- Disfruta de todo el aroma y sabor de un café recién molido.
- Embudo de 200 g de capacidad con tapa.
- Fresa cónica de acero inoxidable; muele el café uniformemente.
- 19 diferentes niveles de molido; se adapta a todo tipo de cafeteras y a la intensidad de sabor que se desee.
- Selector de tazas de 1 a 12 tazas. Mantiene los granos frescos y evita el desperdicio del café.
- Contenedor transparente extraíble de 100 g. Libre de BPA.

- Enjoy the taste and aroma of freshly ground coffee.
- Hopper with a capacity of 200 g with a lid.
- Conical stainless steel cutter to ensure the coffee is ground uniformly.
- 19 different grind sizes to choose from, suitable for all types of coffee machines and for all flavour intensities.
- Choose between 1 and 12 cups to keep the coffee grounds fresh and avoid wasting coffee.
- Removable 100 g transparent container.BPA-free.

19 diferentes niveles de molienda · 19 different grind sizes



Número de tazas Number of cups	Tiempo de molido Grinding time
2	8 seg
4	12 seg
6	20 seg
8	24 seg
10	28 seg
12	30 seg

AS

Plastic

## Molinillo KALDI

Moulin  
Mühle  
Grinder  
Moinho

Ref	€	W	g	U.Venta
69485	117,70	200	200 / 100	1

Ref	Tensión/Voltage	Potencia/Power	Capacidad/Capacity	Niveles dispensado Levels dispensed	Niveles de molidos Grinding levels	Dimensiones/Sizes	Peso/Weight
69485	220-240 V ; 50/60 Hz	200 W	200 g (granos · grains) 100 g (molido · ground)	12	19	15,2x21x26 cm	1,85 Kg

**Depósito para 60 g de granos de café molido**

Container for 60 g of ground coffee



**Cuchillas de acero inoxidable de gran resistencia**

High strength st. steel blades



**Ideal para moler café y otros alimentos como semillas, hierbas, frutos secos, cereales, sal, pimienta, azúcar o especias**

Perfect for grinding coffee or other alimnts like seeds, herbs, nuts, grains, salt, pepper, sugar or spices

## Molinillo LIMU

Moulin  
Mühle  
Grinder  
Moinho

Ref	€	W	g	U.Venta
69385	37,20	200	60	1

Ref	Tensión/Voltage	Potencia/Power	Capacidad/Capacity	Dimensiones/Sizes	Peso/Weight
69385	220-240 V ; 50/60 Hz	200 W	60 g (9 cups)	Ø10x18 cm	0,780 Kg

Inox  
18/10

Cristal  
Glass



**Muelas cerámicas**

Ceramic burrs



- Muele al instante y conserva mejor las propiedades y aromas.
- Ideal para moler café y otros alimentos como semillas, hierbas, frutos secos, cereales, sal, pimienta, azúcar o especias.

- Moud à l'instant et conserve mieux les propriétés et les arômes.
- Idéal pour moudre le café et d'autres aliments tels que les graines, les herbes, les fruitssecs, les céréales, le sel, le poivre ou les épice.

- Grinds instantly and better preserves the properties and aromas.
- Perfect for grinding coffee or other alimnts like seeds, herbs, nuts, grains, salt, pepper, sugar or spices.

8 Niveles de grosor · 8 Grinding levels



## Molinillo manual

Moulin manuel  
Manuelle Mühle  
Manual grinder  
Moinho manual

Ref	€	g	h (cm)	U.Venta
62817	33,20	45	21	1

# Colección ESPUMADORES DE LECHE



- Disfruta de una espuma fina y cremosa en pocos segundos.
- Capacidad espuma: 115 ml / Capac. calentamiento: 240 ml (69396) - 250 ml (69398).
- Tecnología magnética, el movimiento de los accesorios se crea por atracción (69398).
- Base independiente rotativa de 360°, fácil de rellenar y verter.
- Funcionamiento silencioso. Apagado automático.
- Indicador de luz que visualiza si la leche está caliente o fría.
- Apta para leches vegetales. Fácil de limpiar.

- Obtenez une mousse fine et crémeuse en secondes seulement.
- Capacité de mousse : 115 ml / Capacité de chauffe : 240 ml (69396) - 250 ml (69398).
- Technologie magnétique, le mouvement des accessoires a lieu par attraction (69398).
- Base indépendante rotative de 360°C, sans fil, facile à remplir et à verser.
- Fonctionnement silencieux. Arrêt automatique.
- Indicateur lumineux qui indique si le lait est chaud ou froid.
- Apte pour les laits végétaux. Facile à nettoyer.

- Samtiger Schaum in nur Sekunden genussbereit.
- Milchschaum: 115 ml / warme Milch: 240 ml (69396) - 250 ml (69398).
- Magnettechnik, Zubehör bewegen sich durch Anziehungskraft (69398).
- Die Basis ist um 360° drehbar, ohne Kabel, einfaches Ein- und Ausgießen.
- Geräuscharmer Lauf. Abschaltautomatik.
- Kontrollleuchte zeigt an, ob die Milch warm oder kalt ist.
- Pflanzenmilchgeeignet. Leichte Reinigung.

- Enjoy a fine, creamy foam in as little seconds.
- Frothing capacity: 115 ml / Heating capacity: 240 ml (69396) - 250 ml (69398).
- Magnetic technology: The movement of the accessories is created with attraction (69398).
- 360° rotating independent base, easy to fill and pour.
- Silent operation. Automatic shut-off.
- The indicator light shows whether the milk is hot or cold.
- Suitable for plant milk and easy to clean.

- Desfrute de uma espuma fina e cremosa em apenas unos segundos.
- Capacid. de espuma: 115 ml / Capacid. de aquecimento: 240 ml (69396) - 250 ml (69398).
- Tecnologia magnética: o movimento dos acessórios gera-se pela atração (69398).
- Base independente rotativa de 360°, sem cabos, fácil de encher e de verter.
- Funcionamento silencioso. Desconexão automática.
- Indicador luminoso, que indica se o leite está quente ou frio.
- Apto para leites de origem vegetal. Fácil de limpar.



Jarra de cristal  
Glass jug



## Espumador de leche LATTE

Mousseur à lait  
Milchaufschäumer  
Milk frother  
Espumador de leite

Ref	€	W	ml	U.Venta
69396	61,80	500	240	1

## Espumador de leche MAGNETIC

Mousseur à lait  
Milchaufschäumer  
Milk frother  
Espumador de leite

Ref	€	W	ml	U.Venta
69398	76,80	600	250	1

Ref	Tensión/Voltage	Potencia/Power	Cap. espuma/Cap. foam	Cap. leche/Cap. milk	Base/Base	Dimensiones/Sizes	Peso/Weight
69396	220-240 V; 50/60 Hz	500 W	115 ml	240 ml	360°	Ø10x21 cm	650 g
69398	220-240 V; 50/60 Hz	600 W	115 ml	250 ml	360°	Ø11,8x19,5 cm	900 g

# Colección cafeteras **ESPRESSO**

Inox



- Cafeteras espresso de acero inoxidable con diseño elegante y compacto.
- Ideales para preparar todo tipo de cafés, espresso, cappuccino, latte machiato, té o infusiones.
- Café perfecto y rápido gracias a su potencia y sus bares de presión.
- Sistema de calentamiento rápido Thermoblock, calienta el agua en segundos.
- Fácil de usar, muy intuitiva. Indicadores luminosos en cada función.
- Función manual y automática. Permite programar el ciclo de vertido a tu gusto.
- Incluye vaporizador con rotación para espumar leche, preparar cappuccinos y también dispensar agua caliente para las infusiones.
- Brazo portafiltros con doble salida, te permite preparar uno o dos cafés simultáneamente.
- Depósito de agua extraíble con marcas de máximo y mínimo. Libre de BPA.
- Bandeja calienta tazas de acero inoxidable, calienta la taza previamente para evitar el contraste térmico.
- Bandeja de goteo desmontable con indicador de nivel para facilitar la limpieza.
- Sistema de ahorro energético con apagado automático.
- Apta para usar con café molido y con cápsulas ESE (69256 / 69429).

- Stainless steel espresso maker with elegant and compact design.
- Perfect for making all kinds of coffee, espresso, cappuccino, latte macchiato, tea or infusions.
- It can make perfect coffee quickly thanks to power and bars of pressure.
- Its Thermoblock fast heating system heats water in seconds.
- It is easy to use and very intuitive and has light indicators for every function.
- Manual and automatic operation, the amount of coffee to be made can be programmed to taste.
- Swivelling steam wand included to froth milk and make cappuccino. It also dispenses hot water for infusions.
- The portafilter with two outlets lets you make one or two cups of coffee at the same time.
- It has a removable water tank with minimum and maximum marks. BPA free.
- It has a stainless steel cup heating tray to heat cups beforehand to prevent temperature contrasts.
- It has a removable drip tray with a level indicator to make cleaning easy.
- It has an energy savings system with automatic shut off.
- It can be used with ground coffee or ESE pods (69256 / 69429).



**Accesorios incluidos**  
Accessories included



**Apta para café molido y para usar con cápsulas ESE**  
Suitable for ground coffee and for use with ESE capsules



**Prepara 1 o 2 cafés**  
Make 1 or 2 coffees



**Calienta y espuma la leche**  
Heat and froth milk



**Prensador para café molido**  
Tamper for ground coffee



**Bandeja calienta tazas**  
Cup warming tray



**Bandeja de goteo con indicador**  
Drip tray with indicator

*new*



## Cafetera espresso **COMPACT**

Cafetière espresso  
Espresso-Maschine  
Espresso coffee maker  
Cafeteira espresso

Ref	€	W	L	U.Venta
69429	228,90	1450	1,25	1

Ref	Tensión/Voltage	Potencia/Power	Presión/Pressure	Capacidad/Capacity	Dimensiones/Sizes	Peso/Weight
69429	220-240 V ; 50/60 Hz	1450 W	20 bar	1,25 L	14x31x31 cm	3,40 Kg



**Depósito de agua extraíble de 1,50 litros**  
removable 1.50 litre water tank



**Apta para café molido y para usar con cápsulas ESE**  
Suitable for ground coffee and for use with ESE capsules



**Un café**  
A coffee



**Dos cafés**  
Two coffees



**Calentar y espumar leche**  
Heat and froth milk



**Prensador para café molido**  
Tampor for ground coffee



**Bandeja calienta tazas**  
Cup warming tray



**Bandeja de goteo con indicador**  
Drip tray with indicator



## Cafetera espresso SENCE

Cafetière espresso  
Espresso-Maschine  
Espresso coffee maker  
Cafeteira espresso

Ref	€	W	L	U.Venta
69256	184,20	850	1,50	1

Ref	Tensión/Voltage	Potencia/Power	Presión/Pressure	Capacidad/Capacity	Dimensiones/Sizes	Peso/Weight
69256	220-240 V ; 50/60 Hz	850 W	15 bar	1,50 L	21x26,5x30 cm	3,60 Kg

**Molinillo con fresa cónica de acero inoxidable**  
Coffee grinder with a stainless steel cone burr



**Prepara 1 o 2 cafés**  
Make 1 or 2 coffees



**Calienta y espuma la leche**  
Heat and froth milk



new



**Accesorios incluidos**  
Accessories included



**Prensador para café molido**  
Tampor for ground coffee



**Bandeja calienta tazas**  
Cup warming tray



**Café recién molido al instante**  
Instant fresh ground coffee



**Proporciona la cantidad necesaria**  
Provide the amount needed



**Bandeja de goteo con indicador**  
Drip tray with indicator



## Cafetera Espresso PRO

Cafetière Espresso  
Espresso-Maschine  
Espresso coffee maker  
Cafeteira Espresso

Ref	€	W	L	U.Venta
69428	641,90	1550	2,80	1

Ref	Tensión/Voltage	Potencia/Power	Presión/Pressure	Capacidad/Capacity	Capacidad/Capacity	Dimensiones/Sizes	Peso/Weight
69428	220-240 V ; 50/60 Hz	1550 W	20 bar	2,80 L (depósito agua)	250 g (depósito café)	31x34,5x41,5 cm	8,00 Kg



# Colección cafeteras INOX

Inox  
18/10



Vitro

Electric

Gas

Induction

Dishwasher



- Cafetera italiana fabricada en acero inoxidable 18/10 de gran calidad y máxima resistencia.
- Boquilla en pico para servir directamente sin derramar ni una sola gota.
- Máxima seguridad garantizada: dispone de válvula de seguridad y asa termorresistente.
- 100% hermético gracias a su junta de cierre de silicona.
- Alta conductividad térmica.
- Capacidad para 4/6/10 tazas de café.
- Fondo FULL INDUCTION: apta para todo tipo de fuegos, incluida la inducción.
- Muy fácil de limpiar: apta para el lavavajillas.

- Cafetière italienne fabriquée en acier inoxydable 18/10 de grande qualité et d'une résistance maximale.
- Bec verseur en pointe pour servir directement sans renverser une seule goutte.
- Sécurité maximum garantie : dispose d'une soupape de sécurité et d'une anse thermorésistante.
- 100% hermétique grâce à son joint de fermeture en silicone.
- Haute conductivité thermique.
- Capacité pour 4/6/10 tasses de café.
- Fond FULL INDUCTION : apte pour tout type de cuisinières, y compris l'induction.
- Très facile à nettoyer : apte pour le lave-vaisselle.

- Espressokanne aus äußerst widerstandsfähigem und hochwertigem Edelstahl 18/10.
- Schnabelförmige Austrittsöffnung zum direkten Ausschütten, ohne einen Tropfen zu verschütten.
- Maximale Sicherheit garantiert: Überdruckventil und hitzebeständiger Griff.
- 100 % dichter Verschluss mit Silikondichtung.
- Hohe Wärmeleitfähigkeit.
- Fassungsvermögen: 4/6/10 Kaffeetassen.
- FULL-INDUCTION-Boden: Für alle Herdarten inklusive Induktion geeignet.
- Kinderleicht zu reinigen: spülmaschinenfest.

- Moka pot made of high quality and extremely strong 18/10 stainless steel.
- Pointed spout for serving the coffee without spilling a drop.
- Guaranteed maximum safety: pressure valve and heat resistant handle.
- 100% Hermetic because of the silicone seal.
- High thermal conductivity.
- Capacity for 4/6/10 cups of coffee.
- FULL INDUCTION bottom: suitable for all kinds of cookers, including induction.
- It's very easy to clean and dishwasher safe.

- Cafeteira italiana fabricada em aço inoxidável 18/10 de grande qualidade e máxima resistência.
- Boquilha em bico para servir diretamente sem derramar uma única gota.
- Máxima segurança garantida: com válvula de segurança e asa termo resistente.
- 100% hermética, graças à sua junta de fecho de silicone.
- Excelente condutividade térmica.
- Capacidade para 4/6/10 chávenas de café.
- Fundo FULL INDUCTION: apta para todo o tipo de fogões, incluindo as placas de indução.
- Muito fácil de limpar: apta para máquinas de lavar louça.



Disponen de válvula de seguridad  
They have a pressure valve

Acabado MATE  
SATIN finish



## Cafetera express HYPERLUXE

Cafetière express  
Espressokocher  
Express coffee  
Cafeteira café expresso

Ref	€	Tazas	U.Venta
62074	80,40	4	1
62076	88,80	6	1
62071	101,50	10	1

Acabado BRILLO  
GLOSS finish



## Cafetera express LUXE

Cafetière express  
Espressokocher  
Express coffee  
Cafeteira café expresso

Ref	€	Tazas	U.Venta
62084	65,80	4	1
62086	76,80	6	1
62081	90,70	10	1

new

Acabado BRILLO  
GLOSS finish**Cafetera express MOKA**Cafetière express  
Espressokocher  
Express coffee pot  
Cafeteira expresso

Ref	€	Tazas	ml	U.Venta
62054	55,00	4	200	1
62056	63,00	6	310	1
62051	74,70	10	500	1

Acabado BRILLO  
GLOSS finish**Cafetera express MILAN**Cafetière express  
Espressokocher  
Express coffee pot  
Cafeteira expresso

Ref	€	Tazas	Ø Base (cm)	h (cm)	U.Venta
62033	21,50	4	8,0	16,0	1
62036	25,10	6	9,0	19,5	1
62031	31,30	10	10,0	21,0	1

new

Vidrio borosilicato superresistente a  
cambios de temperaturaBorosilicate glass, extremely resistant  
to temperatures changesAcabado BRILLO  
GLOSS finish**Cafetera express SIENA**Cafetière express  
Espressokocher  
Express coffee pot  
Cafeteira expresso

Ref	€	Tazas	Ø Base (cm)	h (cm)	U.Venta
62124	48,60	4	8,5	18,0	1
62126	58,70	6	9,0	18,5	1
62121	70,20	10	10,5	21,5	1

Asa abatible y pomo de baquelita

Folding handle and Bakelite knob

Acabado BRILLO  
GLOSS finish**Cafetera PAVA**Cafetière pava  
Kaffeekanne Pava  
Coffee pot  
Chaleira

Ref	€	Ø Base (cm)	L	U.Venta
68215	34,70	10,0	1,00	1
68225	41,80	13,5	2,00	1
68235	51,00	15,0	2,80	1
68205	58,70	16,0	4,00	1

Agua y café molido infusionan consiguiendo  
un café de gran sabor y aromaWater and ground coffee infuse to make  
a coffee with great taste and aroma

# Colección Cafeteras ALUMINIO

new



- Cafetera italiana fabricada en aluminio fundido de gran calidad y máxima resistencia.
- Máxima seguridad garantizada: dispone de válvula de seguridad y asa de baquelita (Turin) / asa de madera de Haya (Trento) termorresistente.
- 100% hermético gracias a su junta de cierre de silicona.
- Alta conductividad térmica.

- Cafetières italienne fabriquées en fonte d'aluminium de grande qualité et d'une résistance maximale.
- Sécurité maximum garantie : dispose d'une soupape de sécurité et d'une anse en bakélite (Turin) anse en bois de hêtre (Trento) thermorésistante.
- 100% hermétique grâce à son joint de fermeture en silicone.
- Haute conductivité thermique.

- Italienische Kaffeemaschine aus äußerst widerstandsfähigem und hochwertigem Aluminiumguss.
- Maximale Sicherheit garantiert: Überdruckventil und hitzebeständiger Griff aus Bakelit (Turin) / Griff aus Buchenholz (Trento).
- 100 % dichter Verschluss mit Silikondichtung.
- Hohe Wärmeleitfähigkeit.

- Moka pot coffee maker made of high quality and very strong cast aluminium.
- Guaranteed maximum safety: pressure valve and heat resistant bakelite handle (Turin) / beech wood handle (trento).
- 100% Hermetic because of the silicone seal.
- High thermal conductivity.

- Cafeteira italiana fabricada em alumínio fundido de grande qualidade e máxima resistência.
- Máxima segurança garantida: com válvula de segurança e asa de baquelite (Turin) / asa de madeira de faia (Trento) termo resistente.
- 100% hermética, graças à sua junta de fecho de silicone.
- Excelente condutividade térmica.



## Cafetera express TURIN

Cafetiere express  
Espressokocher  
Express coffee pot  
Cafeteira expresso



Ref	€	Tazas	Ø Base (cm)	h (cm)	U.Venta
62026	16,90	6	9,5	19,0	1
62029	21,10	9	10,5	21,5	1
62022	23,30	12	12,0	25,0	1

## Cafetera express TRENTO BLACK

Cafetiere express  
Espressokocher  
Express coffee pot  
Cafeteira expresso



Ref	€	Tazas	Ø Base (cm)	h (cm)	U.Venta
62046	29,90	6	8,5	20,0	1
62048	38,10	9	9,0	22,5	1

## Cafetera express TRENTO BLACK

Cafetiere express  
Espressokocher  
Express coffee pot  
Cafeteira expresso



Ref	€	Tazas	Ø Base (cm)	h (cm)	U.Venta
62096	29,90	6	8,5	20,0	1
62099	38,10	9	9,0	22,5	1

# Colección Cafeteras **FRANCESAS**



- Cafeteras clásicas manuales.
- Fabricadas en vidrio borosilicatos, superresistentes a los cambios de temperatura.
- Filtro robusto de acero inoxidable 18/10; asegura una buena textura y sabor.
- Boquilla en pico para servir directamente sin derramar ni una sola gota.
- Forma práctica y sencilla de preparar los mejores cafés e infusiones en pocos minutos.

- Cafetières classiques manuelles.
- Fabriquées en verre borosilicate, super résistant aux changements de température.
- Filtre robuste en acier inoxydable 18/10 ; garantit une texture et un goût excellents.
- Bec verseur pour servir directement sans renverser pas une seule goutte.
- Façon pratique et simple de préparer les meilleurs cafés et infusions en quelques minutes seulement.

- Klassische Handkaffeemaschine.
- Hergestellt aus Borosilikatglas, super widerstandsfähig gegen Temperaturänderungen.
- Robuster Edelstahlfilter 18/10, gewährleistet gute Textur und gutes Aroma.
- Ausgießtülle zum direkten Servieren ohne einen einzigen Tropfen verschütten.
- Praktische und einfache Weise, die besten Kaffees und Tee in wenigen Minuten zuzubereiten.

- Traditional manual coffee maker.
- Made of borosilicate glass, extremely resistant to temperatures changes.
- High strength stainless steel 18/10 filter that ensures good flavour and texture.
- Spout nozzle to serve directly without spill not a single drop.
- An easy and practical way to make the best coffee and tea in just a few minutes.

- Cafeteiras clássicas manuales.
- Fabricadas em vidro borossilicato, super resistente a mudanças de temperatura.
- Boquilha em bico para servir diretamente sem derramar uma única gota.
- Filtro robusto de aço inoxidável 18/10, que assegura boa textura e sabor.
- Uma maneira prática e simples de preparar os melhores cafés e infusões em poucos minutos.



new

Acabado en color cobre  
Copper-colored finish

## Cafetera francesa COPPER

Cafetière à piston  
Französische kaffemaschine  
French coffee maker  
Cafeteira francesa

Ref	€	Tazas	L	U.Venta
62173	19,10	3	0,35	1
62178	26,10	6	0,80	1



## Cafetera francesa BLACK

Cafetière à piston  
Französische kaffemaschine  
French coffee maker  
Cafeteira francesa

Ref	€	Tazas	L	U.Venta
62183	8,30	3	0,35	6
62186	12,80	6	0,80	1



## Bambú

Bamboo

## Cafetera francesa WOOD

Cafetière à piston  
Französische kaffemaschine  
French coffee maker  
Cafeteira francesa

Ref	€	Tazas	L	U.Venta
62163	10,90	3	0,35	1
62168	14,60	6	0,80	1



## Inox

## Cafetera de cristal

Cafetière en verre  
Glaskaffeemaschine  
Coffee pot w/glass  
Cafeteira vidro

Ref	€	Tazas	L	U.Venta
62153	29,60	2	0,35	1
62180	42,00	6	0,80	1



# Batidor CAPUCCINO



**Incluye:** Vaso medidor  
Base para guardar el batidor y varillas  
Varilla agitadora  
Varilla para espumar  
Batidor  
Mezclador

**Includes:** Measuring cup  
Base to store the whisk and rods  
Stirring rod  
Frothing rod  
Whisk  
Mixer

## Batidor capuccino

Batteur pour capuccino  
Capuccino- Mixer  
Capuccino mixer  
Batedor capuccino

Ref	€	W	U.Venta
69041	26,70	2,7	1

# Colección LECHERAS INOX



Inox

## Lechera

Pot crémier  
Milchkanne  
Milk jug  
Leiteira

	Ref	€	Color	L	e (mm)	U.Venta
A	58151	13,50	GREY	0,35	1	1
	58152	16,10	GREY	0,60	1	1
B	58251	13,50	RED	0,35	1	1
	58252	16,10	RED	0,60	1	1

- Ideales para bares, cafeterías, hoteles, restaurantes, hogares, etc.
- Fabricadas en acero Inoxidable de máxima calidad, resistente y duradera.
- Pueden utilizarse tanto para líquidos calientes como fríos.
- Perfectas para espumar, calentar y servir la leche con el té o café.
- Boquilla vertedora para evitar goteos y un mango resistente al calor.
- Diseñadas para soportar altas temperaturas. Aptas para el lavavajillas.

- Idéal pour les bars, les cafétérias, les hôtels, les restaurants, pour un usage domestique, etc.
- Fabriqué en acier inoxydable de la plus grande qualité, résistant et durable.
- Peut être utilisé aussi bien pour des liquides chauds que froids.
- Parfait pour mousser ou réchauffer et servir le lait avec le thé ou le café.
- Bec verseur anti-goutte et manche résistant à la chaleur.
- Conçu pour supporter de hautes températures. Aptes pour le lave-vaisselle.

- Ideal for bars, cafés, hotels, restaurants, homes, etc.
- Manufactured in high-quality, strong and durable stainless steel.
- Can be used for both hot and cold liquids.
- Perfect for frothing or heating and serving milk with tea or coffee.
- Pouring spout to prevent dripping and heat-resistant handle.
- Designed to withstand high temperatures. Dishwasher safe.



Inox  
18/10

## Lechera barista

Pot crémier pour baristas  
Milchkanne für Baristas  
Barista milk jug  
Leiteira barista

	Ref	€	Color	L	e (mm)	U.Venta
A	58050	28,40	INOX	0,50	1	1
B	58150	31,30	GREY	0,50	1	1
C	58250	31,30	RED	0,50	1	1

Colección **CLASSIC**Inox  
18/10

Dishwasher

**Tetera**Théière  
Teekanne  
Tea pot  
Bule

Ref	€	L	U.Venta
62023	18,90	0,23	12
62035	21,00	0,35	12
62060	28,60	0,60	6
62010	35,10	1,00	1

**Cafetera**Cafetière  
Kaffeekanne  
Coffee pot  
Cafeteira

Ref	€	L	U.Venta
62135	22,90	0,35	6
62160	30,80	0,60	6
62110	34,10	1,00	6
62115	47,60	1,50	1
62120	54,80	2,00	1

**Lechera**Cremiere  
Milchkanne  
Creamer  
Leiteira

Ref	€	L	U.Venta
62215	8,80	0,15	6
62225	14,00	0,25	6
62235	14,70	0,35	6
62260	17,20	0,60	6
62210	21,50	1,00	6
62216	33,40	1,50	6
62220	39,80	2,00	1

**Azucarero**Sucrier  
Zuckerdose  
Sugar bowl  
Açucareiro

Ref	€	L	U.Venta
A 62001	16,00	0,23	6
B 62003	20,70	0,35	1

Colección **LUXE**Inox  
18/10

Dishwasher

**Tetera**Théière  
Teekanne  
Tea pot  
Bule

Ref	€	L	U.Venta
65025	37,80	0,25	1
65035	40,00	0,35	1
65060	47,20	0,60	1
65012	59,40	1,20	1

**Cafetera**Cafetière  
Kaffeekanne  
Coffee pot  
Cafeteira

Ref	€	L	U.Venta
65135	39,40	0,35	1
65160	47,10	0,60	1
65110	59,80	1,00	1

**Lechera**Cremiere  
Milchkanne  
Creamer  
Leiteira

Ref	€	L	U.Venta
65215	14,30	0,15	6
65235	24,50	0,35	6
65260	29,50	0,60	6
65210	42,30	1,00	1



# Colección TETERAS DE HIERRO



**Para los amantes del té**  
 Pour les amateurs de thé  
 Für Liebhaber von Tee  
 For tea lovers  
 Para os amantes de chá

- Teteras fabricadas artesanalmente en hierro fundido de alta calidad muy resistentes.
- Incluyen infusor extraíble de acero inoxidable.
- Interior esmaltado para evitar la oxidación.
- Se recomienda hacer uso de un hervidor para calentar el agua y evitar así que pierda el color.
- Théière fabriquée artisanalement en fonte d'aluminium de grande qualité, très résistante.
- Inclut un infuseur extractible en acier inoxydable.
- Intérieur émaillé pour éviter l'oxydation.
- Il est recommandé d'utiliser une bouilloire pour faire chauffer l'eau et ainsi éviter que la théière ne perde sa couleur.
- Von Hand gefertigte Teekanne aus hochwertigem Gusseisen, sehr robust.
- Einschließlich Teefilter aus rostfreiem Stahl.
- Innen emailiert, um Rostbildung zu vermeiden.
- Es wird empfohlen, zum Erhitzen des Wassers einen Wasserkocher zu verwenden, damit keine Verfärbungen an der Teekanne auftreten.
- This is a high quality, very resistant hand-made, cast iron tea pot.
- Includes a removable, stainless steel infuser.
- Interior is enameled to avoid rusting.
- It's recommended using a boiler to heat the water and thus keep it from losing its colour.
- Chaleira fabricada artesanalmente em ferro fundido de alta qualidade e muito resistente.
- Inclui infusor extraível em aço inoxidável.
- Interior esmaltado para evitar a oxidação.
- Se recomenda utilizar um fervedor para aquecer a água e assim evitar perdas de cor.

Red



White



Bamboo



Black



Green



Brown



## Tetera

Théière  
 Teekanne  
 Tea pot  
 Bule

Ref	€	L	Color	U.Venta
68663	29,30	0,25	Red	1
68667	39,20	0,50	White	1
68666	32,70	0,60	Bamboo	1
68664	47,70	0,70	Black	1
68662	43,70	0,80	Green	1
68668	35,90	0,80	Brown	1
68661	40,50	1,10	Blue	1
68665	36,00	0,65	Magma	1
68669	36,50	1,00	Magma	1

Blue



Magma (0,65 L)



Magma (1,0 L)



# Hervidores SILBANTES

Inox  
18/10



## Hervidor silbante

Bouillire sifflante  
Flötenwasserkessel  
Whistling kettle  
Chaleira com apito

Ref	€	L	U.Venta
68619	37,40	2,00	1
68627	39,40	2,50	1
68629	41,90	3,00	1
68639	43,30	4,00	1



- Alto nivel de calidad y resistencia.
- Apto para hervir agua o calentar café preparado.
- Emite un ligero silbido cuando el agua hierve.

- Haut niveau de qualité et de résistance.
- Apte pour faire bouillir de l'eau et réchauffer du café préparé.
- Émet un léger sifflement lorsque l'eau bout.

- Hochwertig und stabil.
- Zum Kochen von Wasser oder Erwärmen von Kaffee geeignet.
- Wenn das Wasser kocht, ertönt ein akustisches Signal.

- High level of quality and resistance.
- Suitable for boiling water or heating prepared coffee.
- Emits a gentle whistle when the water comes to the boil.

- Alto nível de qualidade e resistência.
- Apto para ferver água ou para aquecer café preparado.
- Emite um ligeiro silvo quando a água ferve.

## Hervidor silbante

Bouillire sifflante  
Flötenwasserkessel  
Whistling kettle  
Chaleira com apito

Ref	€	Color	L	U.Venta
68643	46,40	Blanco · White	2,50	1
68644	46,40	Negro · Black	2,50	1



# Pinzas para TÉ

Inox  
18/10



Dishwasher



Exprime al máximo cada bolsita de té  
Squeezing out the last drop

- Exprime fácilmente tu infusión sin riesgo de mancharte o quemarte.
- Fabricada en acero inoxidable 18/10 de alta calidad, duradera y resistente al óxido.
- Diseñada para una extracción fácil y efectiva de la bolsa de té.
- Orificios para exprimir hasta la última gota.
- Mango de acero inoxidable para un agarre cómodo y seguro.

- Pressez facilement votre infusion sans risque de vous tacher ou de vous brûler.
- Fabriquée en acier inoxydable 18/10 de haute qualité, durable et résistante à la rouille.
- Conçue pour une extraction facile et efficace des sachets de thé.
- Elle dispose de trous pour presser jusqu'à la dernière goutte.
- Poignée en acier inoxydable pour une prise en main confortable et sûre.

- Drücken Sie Ihre Infusion leicht zusammen, ohne dass Sie sich verfärben oder verbrennen können.
- Aus Edelstahl 18/10, haltbar, robust, hochwertig, rostfest.
- So lassen sich Teebeutel einfach und gut aus der Tasse nehmen.
- Ablauflöcher zum gründlichen Ausdrücken des Beutels.
- Edelstahlgriff für bequemen und sicheren Griff.

- Squeeze easily your infusion without the risk of staining or burning yourself.
- Made of high quality 18/10 stainless steel, long lasting and corrosion resistant.
- Designed for easy and effective tea bag removal.
- Holes for squeezing out the last drop.
- Stainless steel handle for a comfortable and safe grip.

- Esprema facilmente a sua infusão sem risco de manchar ou queimar-se.
- Fabricada em aço inoxidável 18/10 de alta qualidade, durável e resistente ao óxido.
- Pensada para retirar fácil e eficazmente os saquinhos de chá.
- Os orifícios permitem espremer completamente o saquinho de chá.
- Mango de aço inoxidável para uma sujeição confortável e seguro.



## Pinza para bolsitas de té

Pince pour sachets de thé  
Teebeutelzange  
Tea bag tong  
Pinças para saquetas de chá

	Ref	€	cm	U.Venta
A	68078	2,30	13,5	1
B	68079	3,50	14,0	1



# Colección HERVIDORES DE AGUA

Inox  
18/10



- Hervidor de agua retro fabricado en acero inoxidable 18/10, acabado en gris mate.
- Permite calentar el agua de manera rápida y eficiente.
- Botón luminoso de encendido/apagado.
- Base independiente rotativa de 360°.
- Control STRIX, vida útil superior al controlador estándar. Protección contra el calentamiento en vacío muy preciso. Apagado automático.
- Visor de nivel de agua. Boquilla con filtro. Mango termorresistente.

- Bouilloire rétro fabriquée en acier inoxydable 18/10, finition gris mat.
- Permet de chauffer l'eau de façon rapide et efficace.
- Bouton lumineux de marche/arrêt.
- Base indépendante rotative à 360°.
- Contrôle STRIX, durée de vie utile supérieure au contrôleur standard. Protection contre la chauffe à vide très précis. Arrêt automatique.
- Visualisation du niveau d'eau. Buse avec filtre. Poignée thermo-résistant.

- Retro Wasserkocher. Material: Edelstahl 18/10. Farbe: Mattgrau.
- Erhitzt Wasser schnell und sparsam.
- Leuchtender Ein-/Ausshalter.
- Sockel als Einzelteil um 360° drehbar.
- STRIX-Steuerung mit überdurchschnittlicher Lebensdauer. Äußerst zuverlässiger Leerlaufschutz. Abschaltautomatik.
- Wasserstandsanzeige. Düse mit Filter. Griff hitzebeständig.

- Retro kettle made of 18/10 stainless steel with a matte grey finish.
- It can be used to heat water quickly and efficiently.
- Illuminated on/off button.
- Independent base rotates 360°.
- STRIX controller: useful life longer than a standard controller. Very precise protection against heating while empty. Automatic Shut-off.
- Water level viewer. Nozzle with filter. Heat-resistant handle.

- Fervedor de água retro, fabricado em aço inoxidável 18/10, com acabamento cinzento mate.
- Permite aquecer a água de maneira rápida e eficiente.
- Botão luminoso de ligar/desligar.
- Base independente e rotativa de 360°.
- Controlo STRIX, que proporciona uma vida útil superior à de um controlador standard. Proteção de grande precisão contra o aquecimento em vazio. Desconexão automática.
- Indicador de nível de água. Bocal com filtro. Asa termorresistente.

Permite calentar el agua de manera rápida y eficiente

It can be used to heat water quickly and efficiently



**Base independiente rotativa de 360°**  
Independent base rotates 360°



**Botón luminoso de encendido/apagado**  
Illuminated on/off button



**Fácil llenado**  
Easy filling



**Interior inox 18/10**  
Interior 18/10 st. steel



**Boquilla con filtro**  
Nozzle with filter



**Indicador de nivel de agua**  
Water level indicator

## Hervidor de agua RETRO

Bouilloire électrique

Elektrische Wasserwamer

Electric kettle

Chaleira eléctrica

Ref	€	W	L	U.Venta
69397	58,20	2200	1,7	1

Strix  
Technology



Ref	Tensión/Voltage	Potencia/Power	Capacidad/Capacity	Dimensiones/Sizes	Peso/Weight
69397	220-240 V ; 50/60 Hz	2200 W	1,70 L	26x19,5x26,5 cm	1,20 Kg



**Filtro extraíble antical**  
Removable anti-cal filter



**Visor de nivel de agua**  
Water level



**Base rotativa de 360°**  
360° rotating base



**Calefactor oculto**  
Hidden heater

**Apagado automático**  
Automatic shutdown

**Se desactiva cuando alcanza el nivel de temperatura deseada**  
It is deactivated when it reaches the desired temperature level



**Botón apertura tapa**  
Cover opening button

**Botón de encendido/apagado**  
On/off button

**Luz LED**  
LED light

## Hervidor de agua

Bouilloire  
Wasserwamer  
Kettle  
Chaleira

	Ref	€	Color	W	L	U.Venta
A	69590	22,60	GREY	2200	1,30	1
B	69591	22,60	WHITE	2200	1,30	1

Ref	Tensión/Voltage	Potencia/Power	Capacidad/Capacity	Dimensiones/Sizes	Peso/Weight
69590	220-240 V; 50/60 Hz	2200 W	1,30 L	20x15x21 cm	0,74 Kg
69591	220-240 V; 50/60 Hz	2200 W	1,30 L	20x15x21 cm	0,74 Kg

**Strix**  
Technology



**Botón apertura tapa**  
Cover opening button



**Botón apertura tapa**  
Cover opening button



**Visor de nivel de agua**  
Water level



## Hervidor de agua LAKE

Bouilloire  
Wasserwamer  
Kettle  
Chaleira

Ref	€	W	L	U.Venta
69277	59,70	2200	1,70	1

## Hervidor de agua RAPID

Bouilloire  
Wasserwamer  
Kettle  
Chaleira

Ref	€	W	L	U.Venta
69291	39,80	1630	1,00	1
69297	49,70	2200	1,70	1

Ref	Tensión/Voltage	Potencia/Power	Capacidad/Capacity	Dimensiones/Sizes	Peso/Weight
69277	220-240 V; 50/60 Hz	2200 W	1,70 L (5 min)	23x16x23 cm	1,00 Kg
69291	220-240 V; 50/60 Hz	1630 W	1,00 L (3 min)	22x16x21 cm	1,10 Kg
69297	220-240 V; 50/60 Hz	2200 W	1,70 L (5 min)	22x18x23 cm	1,65 Kg

**Botón apertura de tapa**

Button for opening the boiler cap



**Protección de ebullición en seco**  
Dry boil protection



- Base para conector de 360°.
- Se apagará automáticamente cuando el agua hierva.
- Elemento de calefacción oculto.
- Indicador de luz de encendido/apagado.
- La temperatura se puede ajustar de 50°C-95°C.
- Almacenamiento de cable.

- Base pour connecteur de 360°.
- S'éteint automatiquement lorsque l'eau bout.
- Élément de chauffe caché.
- Indicateur lumineux de marche / arrêt.
- La température peut être réglée entre 50°C et 95°C.
- Rangement du câble.

- Base for 360° connector.
- The wireless boiler will automatically switch off when the water boils.
- Hidden heating element.
- ON/OFF light.
- The temperature can be adjusted from 50°C - 95°C.
- Cable storage.



**Cristal**

Glass

**Hervidor de agua**

Bouilloire  
Wasserwamer  
Kettle  
Chaleira

Ref	€	W	L	U.Venta
69292	80,70	2200	1,70	1

Ref	Tensión/Voltage	Potencia/Power	Temperatura/Temp.	Capacidad/Capacity	Dimensiones/Sizes	Peso/Weight
69292	220-240 V; 50 Hz	2200 W	50 - 95°C	1,70 L	23x23x32 cm	1,90 Kg

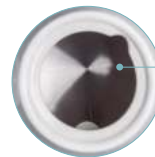

**Interior Inox 18/10. Calentamiento rápido**  
Interior 18/10 st. steel. Fast heating

- Cuerpo cerámico, ecológico y resistente a altas temperaturas.
- Base independiente rotativa de 360°.
- Tapa extraíble con cierre.
- Indicador de capacidad máxima.
- Interruptor de encendido/apagado luminoso.
- Protección de sobrecalentamiento y funcionamiento en seco.
- Función de apagado automático.

- Corps céramique, écologique et résistant aux températures élevées.
- Base indépendante rotative à 360°.
- Couvercle extractible avec fermeture.
- Indicateur de capacité maximale.
- Interrupteur de marche/arrêt lumineux.
- Protection contre la surchauffe et fonctionnement à sec.
- Fonction d'arrêt automatique.

- Ceramic body, ecological and resistant to high temperatures.
- 360° rotating independent base.
- Removable lid with closure.
- Maximum capacity indicator.
- Light up on/off switch.
- Protection from overheating and dry running.
- Auto-off function.

**CE**

Ceramic

**Hervidor de agua cerámico**

Bouilloire en céramique  
Keramik Wasserwarmer  
Ceramic kettle  
Chaleira cerâmica



	Ref	€	Nombre	W	L	U.Venta
A	69276	51,70	GALA	1500	1,20	1
B	69289	56,50	GALA GREY	1200	1,00	1

Ref	Tensión/Voltage	Potencia/Power	Capacidad/Capacity	Dimensiones/Sizes	Peso/Weight
69276	220-240 V; 50/60 Hz	1500 W	1,2 L	24x17x25 cm	1,68 Kg
69289	220-240 V; 50/60 Hz	1200 W	1,0 L	23x16,5x23 cm	1,40 Kg

# Dispensador de agua caliente **INSTANT**

Inox



- Ideal para oficinas, casas rurales, reuniones, etc.
- Fácil llenado. Depósito extraíble de gran capacidad (2 L) para llenar fácilmente el contenedor.
- Display intuitivo. Elige la cantidad de agua (150 ml - 230 ml- 300 ml) y la temperatura deseada (25°C - 70°C - 85°C - 95°C).
- Cuenta con función de bloqueo de seguridad.
- Ahorra tiempo y energía. Proporciona la cantidad exacta de agua caliente deseada, el agua restante del depósito se mantendrá fría.
- Bandeja de goteo extraíble e imantada, fácil de limpiar y colocar.

- Idéal pour les bureaux, les gîtes ruraux, les réunions, etc.
- Remplissage facile. Réservoir extractible de grande capacité (2 L) pour remplir facilement le conteneur.
- Écran intuitif. Choisissez la quantité d'eau (150 ml - 230 ml- 300 ml) et la température souhaitée (25°C - 70°C - 85°C - 95°C).
- Dispose d'une fonction de blocage de sécurité.
- Gain de temps et économies d'énergie. Fournit la quantité exacte d'eau chaude souhaitée, l'eau restant dans le réservoir restera froide.
- Plateau d'écoulement extractible et aimanté, facile à nettoyer et à installer.

- Ideal für Büros, Landhäuser, Sitzungen usw.
- Einfaches Füllen. Herausnehmbarer Tank mit großem Fassungsvermögen (2 L) zum einfachen Füllen des Behälters.
- Intuitives Display. Wassermenge (150 ml - 230 ml- 300 ml) und erwünschte Temperatur (25°C - 70°C - 85°C - 95°C) wählbar.
- Mit Sicherheitssperre.
- Spart Zeit und Energie. Spendet genau die erwünschte Menge heißes Wasser, im Tank bleibendes Wasser bleibt kalt.
- Herausnehmbare und magnetische Tropfwanne, einfach zu reinigen und anzubringen.

- Perfect for offices, country homes, meetings, etc.
- Easy to fill. Large capacity (2 L) removable tank to easily fill the container.
- Intuitive display. Choose the amount of water (150 ml - 230 ml- 300 ml) and the desired temperature (25°C - 70°C - 85°C - 95°C).
- Includes safety lock feature.
- Save time and energy. Provides the exact amount of hot water desired, while the remaining water in the tank remains cold.
- Removable and magnetic drip tray, easy to clean and replace.

- Ideal para escritórios, casas de turismo rural, reuniões, etc.
- Fácil de encher. Depósito extraível de grande capacidade (2 L) para encher facilmente o recipiente.
- Ecrã intuitivo. Selecione a quantidade de água (150/230/300 ml) e a temperatura desejada (25/70/85/95 °C).
- Função de bloqueio de segurança.
- Poupa tempo e energia. Proporciona a quantidade exata de água quente desejada; a água restante do depósito manter-se-á fria.
- Bandeja de gotejamento extraível e magnética, fácil de limpar e de colocar.

## Display intuitivo

Intuitive display



## Bandeja de goteo extraíble e imantada

Removable and magnetic drip tray

## Agua caliente en 5 segundos

Hot water in 5 seconds



## Dispensador de agua caliente

Distributeur d'eau chaude

Heißwasserspender

Hot water dispenser

Dispensador de água quente

Ref	€	W	U.Venta
69298	124,50	2400	1

Ref	Tensión/Voltage	Potencia/Power	Capacidad/Cap.	Niveles Calentamiento Heating levels	Dispensado agua Water dispensed	Dimensiones/Sizes	Peso/Weight
69298	220-240 V / 50-60 Hz	2400 W	2,00 L	25°C - 70°C - 85°C - 95°C	150-230-300 ml	32x16,8x32,7 cm	2,50 Kg

# Termos • Botellas

Termos • Bottles



# Jarras termo **POLIPROPILENO**



- Jarras termo que mantienen los líquidos calientes y fríos durante horas.
- Ideales para servir café, leche o té.
- Cuerpo de polipropileno, ligero y muy cómodo.
- Doble pared con una capa de vidrio en el interior que proporciona un alto rendimiento térmico.
- Tapa aislante de rosca con botón de apertura que mantiene el calor y dispensa fácilmente las bebidas.
- Uso muy sencillo y eficaz; podrás manejarlo con una sola mano.

- Pichet isotherme qui maintient les liquides chauds et froids pendant des heures.
- Idéales pour servir le café, lait ou le thé.
- Corps en polypropylène, léger et très pratique.
- Double paroi avec ampoule en de verre à l'intérieur qui confère un haut rendement thermique.
- Couvercle isolant à vis avec poussoir d'ouverture qui maintient la chaleur et distribue facilement les boissons.
- Utilisation très simple et efficace ; peut être manipulé avec une seule main.

- Thermos jug that keeps liquids hot and cold for hours.
- Ideal for coffee, milk or tea.
- Polypropylene body, light and very comfortable.
- Double skin with a glass layer inside to provide high thermal performance.
- Insulated screw cap with opening button for easy pouring and to keep the heat in the jug.
- Very simple and efficient to use, can be held in one hand.



**Capa de vidrio en el interior**  
Glass layerinside

new

**Acabado MATE**  
SATIN finish



## HAYA

Beech Wood

### Jarra termo WOOD

Pichet thermo  
Thermoskanne  
Termo jug  
Jarra termo

	Ref	€	Color	cm	L	U.Venta
A	62598	22,10	BLACK	Ø13x25,3	1,00	1
B	62599	22,10	WHITE	Ø13x25,3	1,00	1



- Tapa aislante con pulsador de apertura.
- Irrompible, libre de malos olores.
- Fabricado en resina especial para soportar los golpes.

- Insulating lid with button for opening.
- Shatterproof, free of bad smells.
- Manufactured in special resin to resist bangs.

**Triple pared aislante**  
Triple insulating wall



**Capa de vidrio en el interior**  
Glass layerinside

**Acabado MATE**  
SATIN finish



### Jarra termo

Pichet thermo  
Thermoskanne  
Termo jug  
Jarra termo

	Ref	€	Color	L	U.Venta
	62563	14,90	GREY	1,00	1
A	62564	17,00	GREY	1,50	1
	62575	14,70	WHITE	1,00	1
B	62579	17,00	WHITE	1,50	1

### Jarra termo

Pichet thermo  
Thermoskanne  
Termo jug  
Jarra termo

Ref	€	L	U.Venta
62496	27,10	0,60	1
62491	38,80	1,20	1
62492	48,80	2,00	1



# Jarras termo INOX 18/10

Inox  
18/10



- Jarra termo que mantiene los líquidos calientes y fríos durante horas.
- Ideal para servir té o café.
- Interior y exterior en acero inoxidable de gran calidad.
- Doble pared que proporciona un alto rendimiento térmico.
- Boca amplia; facilita su llenado y su limpieza.
- Tapa aislante de rosca con pulsador de apertura que mantiene el calor y dispensa fácilmente las bebidas.

- Pichet thermos qui maintient les liquides chauds et froids pendant des heures.
- Idéale pour servir le thé ou le café.
- Intérieur et extérieur en acier inoxydable de grande qualité.
- Double paroi qui confère un haut rendement thermique.
- Bec large : facilite son remplissage et son nettoyage.
- Couverture isolant à vis avec poussoir d'ouverture qui maintient la chaleur et distribue facilement les boissons.

- Thermo jug that keeps liquids hot and cold for hours.
- Ideal for serving tea or coffee.
- High-quality stainless steel interior and exterior.
- Double wall that provides high thermal performance.
- Wide mouth makes it easy to fill and clean.
- Insulated screw cap with opening button that retains heat and easily dispenses drinks.



## Jarra termo

Verseuse isothermo  
Thermoskanne, idoliert  
Vacuum flask  
Servidor termo

Ref	€	L	U.Venta
62522	49,90	1,6	1
62523	55,00	2,2	1



## Jarra termo

Verseuse isothermo  
Thermoskanne, idoliert  
Vacuum flask  
Servidor termo

Ref	€	Color	L	U.Venta
<b>A</b> 62483	31,20	Blanco / White	1,00	1
<b>B</b> 62484	31,20	Negro / Black	1,00	1

## Jarra termo

Bouteille thermo  
Thermoskanne  
Insulated server  
Jarra termo Luxe

Ref	€	L	U.Venta
62430	55,70	0,30	1
62460	61,70	0,60	1
62410	68,20	1,00	1
62415	87,90	1,50	1



**Termo Hermético**  
Hermetic cap



## Jarra termo LUXE

Bouteille thermo  
Thermoskanne  
Insulated server  
Jarra termo Luxe

Ref	€	L	U.Venta
63360	67,00	0,60	1
63310	72,90	1,00	1
63315	84,20	1,50	1
63320	89,80	2,00	1

## Jarra termo

Verseuse isothermo  
Thermoskanne, idoliert  
Vacuum flask  
Servidor termo

Ref	€	L	h (mm)	U.Venta
62481	29,70	1,00	160	1
62485	35,10	1,50	200	1
62486	36,10	2,00	220	1



HINWEIS : In Deutschland nicht verfügbar

# Termo AIRPOT



**NO UTILIZAR CON BEBIDAS GASEOSAS, CALDOS NI LÁCTEOS**  
DO NOT USE WITH FIZZY DRINKS, BROTHS OR DAIRY

**Doble pared**  
Double wall



**Boca ancha para cubitos hielo**  
Wide mouth for ice cubes



## Air pot

Air pot  
Getränkenspender, isoliert  
Air pot  
Air pot

Ref	€	L	h (cm)	U.Venta
62472	69,60	2,50	32,5	1
62473	75,50	3,00	34,5	1
62475	101,20	4,00	39,0	1

- Mantiene las bebidas calientes o frías durante 24 horas.
- Doble pared que proporciona un alto rendimiento térmico.
- Ligero e irrompible.
- Boca ancha para cubos de hielo.
- Fácil de abrir y cerrar. Fácil limpieza.

- Maintient les boissons chaudes ou froides pendant 24 heures.
- Double paroi qui confère un haut rendement thermique.
- Léger et incassable.
- Bec large pour glaçons.
- Ouverture et fermeture faciles. Facile a nettoyer.

- Hält die Getränke 24 Stunden warm oder kalt.
- Doppelwandig für hohe Wärmeleistung.
- Leicht und unzerbrechlich.
- Breite Öffnung für Eiswürfel.
- Einfach zu öffnen und zu schließen. Facile a nettoyer.

- Keeps drinks hot or cold for 24 hours.
- Double wall that provides high thermal performance.
- Light and shatterproof.
- Wide mouth for ice cubes.
- Easy to open and close. Facile a nettoyer.

- Mantém as bebidas quentes e frias durante 24 horas.
- Parede dupla, que proporciona um elevado rendimento térmico.
- Leve e inquebrável.
- Abertura larga para cubos de gelo.
- Fácil de abrir e fechar. Fácil de limpar.

# Termo BALA



## Termo para líquidos

Thermo pour liquides  
Thermobehälter für Flüssigkeiten  
Thermo for liquids  
Termo para líquidos

Ref	€	L	h (cm)	U.Venta
62441	12,00	0,35	20,0	1
62442	13,70	0,50	24,8	1
62443	18,50	0,75	29,8	1
62444	19,90	1,00	33,7	1



- Mantiene las bebidas calientes o frías hasta 24 horas.
- Doble pared y cámara de vacío. Alto rendimiento térmico.

- Maintient les boissons chaudes ou froides jusqu'à 24 heures.
- Haut rendement thermique. Double paroi et chambre à vide.

- Hält die Getränke 24 Stunden heiß oder kalt.
- Thermisch leistungsstark. Doppelwände und Vakuumkammer.

- Keeps drinks hot or cold up to 24 hours.
- High thermal efficiency. Double wall and vacuum chamber.

- Mantém as bebidas quentes e frias por até 24 horas.
- Alto desempenho térmico. Parede dupla e câmara de vácuo..

## Termo SOFT TOUCH WHITE

Thermo Soft Touch  
Thermobehälter Soft Touch  
Thermo Soft Touch  
Termo Soft Touch

Ref	€	h (cm)	L	U.Venta
62576	12,80	19	0,35	1
62577	14,20	24	0,50	1
62578	17,50	28	0,75	1





# Termo para ALIMENTOS



- **Cierre hermético: tapa de rosca con junta de silicona para evitar derrames.**
- **Alto rendimiento térmico gracias a su doble pared y a la cámara de vacío del contenedor: mantiene la comida caliente hasta 6 horas y frías hasta 8 horas.**
- **Sistema de boca extra ancha: facilita el llenado y la toma de los alimentos.**
- **Revestimiento exterior en color mate antiralladura (62635/62636).**
- **Materiales atóxicos, 100% libres de BPA.**

- **Airtight seal: screw lid with silicone gasket to prevent spillage.**
- **High thermal performance thanks to the container's double wall and vacuum chamber: it keeps food hot for up to 6 hours and cold for up to 8 hours.**
- **Extra wide mouth system: makes it easy to fill and eat food.**
- **Anti-scratch exterior coating in matt colour.**
- **100% BPA free non-toxic materials.**

- Fermeture hermétique : couvercle à vis avec joint en silicone pour éviter les écoulements.
- Haut rendement thermique grâce à sa double paroi et à la chambre à vide du conteneur : maintient la nourriture chaude jusqu'à 6 heures et froide jusqu'à 8 heures.
- Système d'ouverture extra large : facilite le remplissage et la récupération des aliments.
- Finition extérieure noire mate anti-rayures.
- Matériaux non toxiques, 100% sans BPA.

- Fecho hermético: tampa de rosca com junta de silicone para evitar derramamentos.
- Alto rendimento térmico, graças à sua parede dupla e à câmara de vácuo do recipiente: mantém a comida quente até 6 horas e fria até 8 horas.
- Sistema de boca extra larga, para facilitar o enchimento e o consumo dos alimentos.
- Revestimento exterior de cor mate anti-riscos.
- Materiais não tóxicos, 100% livres de BPA.

- Hermetischer Verschluss: Schraubdeckel mit Silikondichtung verhindert Verschütten.
- Hoher Wärmewirkungsgrad dank Behälter mit Doppelwand und Vakuum. Hält Essen bis 6 Stunden warm und bis 8 Stunden kalt.
- Extra breite Öffnung: einfach zu füllen und zu leeren.
- Matte, kratzfesteste Außenbeschichtung.
- Ungiftige, 100 % BPA-freie Materialien.

**Incluye cuchara plegable de acero inoxidable**  
Includes a folding stainless steel spoon

**Asa de silicona para un agarre ergonómico**  
Silicone handle for a fully ergonomic grip

## Termo para alimentos FLORA

Thermo pour aliments  
Thermobehälter für Speisen  
Thermo for food  
Termo para alimentos

	Ref	€	Ø (cm)	h (cm)	L	U.Venta
A	62635	13,50	8,5	14,5	0,36	1
B	62636	23,60	10,5	15,0	0,50	1



## Termo para alimentos sólidos

Thermo pour aliments solides  
Thermobehälter für feste Speisen  
Thermo for solid food  
Termo para alimentos sólidos

	Ref	€	L	h (cm)	U.Venta
A	62448	20,90	0,70	19,7	1
B	62440	25,00	1,00	23,5	1



## Termo p/alimentos SOFT TOUCH

Thermo pour aliments  
Thermobehälter für Speisen  
Thermo for food  
Termo para alimentos

	Ref	€	h (cm)	L	U.Venta
	62480	52,10	18	1,50	1



# Vasos reutilizables SERVE & GO

new



- Vaso reutilizable fabricado en vidrio borosilicato de gran espesor.
- Tapa de polipropileno con pestaña deslizante, libre de BPA.
- Cierre hermético; 100% a prueba de fugas.
- Banda de silicona antideslizante para un agarre seguro.
- Higiénico y resistente al contraste térmico.
- Diseñado para disfrutar de bebidas calientes o frías para llevar.
- No absorbe olores ni sabores.
- Capacidad de 280 / 450 ml.
- Fácil limpieza; apta para el lavavajillas.

- Verre réutilisable fabriqué en verre borosilicate de grande épaisseur.
- Couvercle en polypropylène avec bec coulissant, sans BPA.
- Fermeture hermétique ; 100% antifuites.
- Bande en silicone antidérapante pour une prise en main sûre.
- Hygiénique et résistant aux contrastes thermiques.
- Conçu pour profiter de boissons chaudes ou froides à emporter.
- N'absorbe ni les odeurs ni les goûts.
- Capacité de 280 / 450 ml.
- Nettoyage facile ; apte pour le lave-vaisselle.

- Wiederverwendbares Glas aus sehr dickem Borsilikat.
- Schiebedeckel aus Polypropylen, BPA-frei.
- 100 % dichter, hermetischer Verschluss.
- Rutschfestes Silikonband für sicheren Halt.
- Hygienisch, widersteht Temperaturunterschieden.
- Zum Mitnehmen von Heiß- und Kaltgetränken.
- Nimmt weder Geschmack noch Geruch an.
- 280 / 450 ml Fassungsvermögen.
- Einfach zu reinigen, spülmaschinengeeignet.

- This reusable glass is made of very thick borosilicate glass.
- It has a BPA free polypropylene lid with a sliding tab.
- Hermetic Seal: 100% leak proof.
- It has a non-slip silicone band for a secure grip.
- It's hygienic and resistant to thermal shock.
- It's designed to enjoy hot and cold drinks on the go.
- It doesn't absorb odours or flavours.
- 280 / 450 ml Capacity.
- Easy to Clean: dishwasher safe.

**Tapa de polipropileno con pestaña deslizante**  
Polypropylene lid with a sliding tab

**Banda de silicona antideslizante**  
Non-slip silicone band



**Vidrio borosilicato de gran espesor**  
Very thick borosilicate glass

- Copo reutilizável, fabricado em vidro borosilicato de grande espessura.
- Tampa de polipropileno com pestana deslizante. Não contém BPA.
- Fecho hermético, 100% à prova de fugas.
- Banda de silicone antideslizante, para uma sujeição segura.
- Higiénico e resistente ao contraste térmico.
- Concebido para desfrutar de bebidas para levar, quentes ou frias.
- Não absorve cheiros nem sabores.
- Capacidade de 280 / 450 ml.
- Fácil de limpar, lavável na máquina de lavar louça.

## Vaso SERVE & GO

Timbale  
Trinkbecher  
Tumbler  
Copo

	Ref	€	Ø (cm)	h (cm)	ml	U.Venta
A	63138	14,60	9	14,0	280	1
B	63139	16,60	9	17,0	450	1

# Colección botellas INOX EDAN & FLORA & ENERGY



- Fabricadas en acero inoxidable 18/10 de la mejor calidad.
- Doble pared de aislamiento, no transmiten el calor o el frío.
- Tapón de rosca hermético, a prueba de filtraciones y antiderrames.
- No transmiten sabores ni olores.
- Libres de BPA.

- Fabriquéés en acier inoxydable 18/10 de la plus grande qualité.
- Double paroi isolante, ne transmet ni la chaleur ni le froid.
- Bouchon à vis hermétique, anti écoulements
- Ne transmettent ni les goûts ni les odeurs.
- Sans BPA.

- Aus Edelstahl 18/10 in höchster Qualität.
- Dank doppelwandiger Isolation werden die Flaschen außen weder warm noch kalt.
- Dichter Schraubdeckel, läuft nicht aus, verschüttet nicht.
- Übertragen keinen Geschmack/ Geruch.
- BPA-frei.

- Made of 18/10 stainless steel of the best quality.
- Double insulation wall, does not conduct heat or cold.
- Leak and spill proof hermetic screw on lid.
- Doesn't transmit flavours or odours.
- BPA free.

- Fabricadas em aço inoxidável 18/10 da melhor qualidade.
- Dupla parede de isolamento, não transmite o calor nem o frio.
- Tampão de rosca hermético, à prova de filtrações e anti-derrames.
- Não transmitem sabores nem cheiros.
- Livres de BPA.

**Acabado exterior con proceso de revestimiento en polvo**  
Outside finished with powder coating process

## Botella inox EDAN BLACK

Bouteille inox  
Stahlflasche  
Stainless steel bottle  
Garrafa de aço inoxidável

Ref	€	L	U.Venta
62536	11,10	0,26	1
62537	12,10	0,50	1
62538	15,00	0,75	1



## Botella Inox EDAN RED

Bouteille inox  
Stahlflasche  
Stainless steel bottle  
Garrafa de aço inoxidável

Ref	€	L	U.Venta
62546	11,10	0,26	1
62547	12,10	0,50	1
62548	15,00	0,75	1



## Botella inox EDAN SKY

Bouteille inox  
Stahlflasche  
Stainless steel bottle  
Garrafa de aço inoxidável

Ref	€	L	U.Venta
62584	11,10	0,26	1
62585	12,10	0,50	1
62586	15,00	0,75	1



## Botella Inox EDAN NAVY

Bouteille inox  
Stahlflasche  
Stainless steel bottle  
Garrafa de aço inoxidável

Ref	€	L	U.Venta
62587	11,10	0,26	1
62588	12,10	0,50	1
62589	15,00	0,75	1



**Tapón de madera con anilla para colgar**

Wood stopper with a ring for hanging



**Botella inox FLORA**

Bouteille inox  
Stahlflasche  
Stainless steel bottle  
Garrafa de aço inoxidável

Ref	€	L	U.Venta
62556	14,10	0,50	1
62559	15,70	0,75	1



**Botella personal ENERGY**

Personnelle bouteille  
Persönliche Flasche  
Personal bottle  
Garrafa pessoal

Ref	€	L	U.Venta
61950	13,90	0,50	1
61965	15,10	0,65	1



- Tapón con doble protección a prueba de goteo.
- Abra la botella con una mano y un sólo clic.
- Boca ancha para meter hielo fácilmente.
- Correa de transporte resistente.
- Botella fabricada en tritán (500 ml / 650 ml). Material libre de BPA.
- Duradera y resistente al impacto.

- Bouchon avec double protection anti-goutte.
- Ouvrez la bouteille d'une seule main et d'un seul clic.
- Ouverture large pour remplir facilement de glace.
- Courroie de transport résistante.
- Bouteille fabriquée en tritan (500 ml / 650 ml). Matériau sans BPA.
- Durable et résistante aux chocs.

- Drip proof double protected lid.
- Open the bottle with just one hand and a click.
- Wide mouth for easy filling with ice.
- Strong carrying strap.
- Bottle is made from Tritan (500 ml / 650 ml). BPA-free material.
- Long lasting and impact resistant.

**Botella termo infusora FLORA**



- Tapa de bambú con junta de silicona  
Cap made of bamboo with silicone seal
- Tapa infusor de acero inoxidable 18/10  
18/10 stainless steel infuser cup
- Infusor de acero inoxidable 18/10  
18/10 stainless steel infuser
- Botella de vidrio borosilicato  
Resistente al contraste térmico  
Borosilicate glass bottle  
Resistant to thermal contrast



- Fabricado en vidrio borosilicato de doble pared de máxima calidad.
- Filtro infusor de acero inoxidable 18/10 extraíble con asa que facilita la extracción.
- Cierre hermético: tapa de rosca fabricada en bambú con junta de silicona. Libre de BPA. 100% a prueba de fugas.
- Diseñado para hacer infusiones, té y bebidas frías.
- 100% sabor y aroma. No transmite olores ni sabores.
- Resistente al contraste térmico.
- Fácil limpieza: apto para el lavavajillas (excepto la tapa).

- Fabriquée en verre borosilicate à double paroi de la plus grande qualité.
- Filtre infuseur en acier inoxydable 18/10 extractible avec poignée qui facilite l'extraction.
- Fermeture hermétique : couvercle à vis fabriqué en bambou avec joint en silicone. Sans BPA. 100% anti-fuites.
- Conçue pour des infusions, du thé et des boissons froides. 100% goût et arôme.
- Ne transmet ni les odeurs ni les goûts.
- Résistante aux contrastes thermiques.
- Facile à nettoyer : apte pour le lave-vaisselle (sauf le couvercle).

- Made of the highest quality double-walled borosilicate glass.
- Removable 18/10 stainless steel infuser filter with handle for easy removal.
- Airtight closure: screw cap made of bamboo with silicone seal. BPA free. 100% leak proof.
- Designed to make herbal teas, teas and cold drinks.
- 100% flavor and aroma. Doesn't transmit aromas or flavors.
- Resistant to thermal contrast.
- Easy cleaning: dishwasher safe (except lid).

**Botella termo infusora**

Bouteille thermos avec infuseur  
Thermo-Teebereiter  
Infuser thermo bottle  
Garrafa termo com infusor

Ref	€	Ø (cm)	h (cm)	ml	U.Venta
62534	15,30	6,6	21,5	350	1



# Bar • Bodega

Bar • Wine cellar



# Colección fundas ENFRIABOTELLAS



- Funda térmica; enfría y mantiene la temperatura durante más tiempo.
- Se adapta a todo tipo de botellas.
- Cubre prácticamente toda la botella, desde la base hasta al cuello.
- Meter la funda térmica en el congelador antes de su uso.
- El gel refrigerante no es tóxico.
- Para lavarlo, utilizar un paño húmedo. No apto para el lavavajillas.

- Housse thermique qui permet de refroidir et de maintenir la température idéale du vin ou du cava pendant plus longtemps.
- S'adapte parfaitement à tout type de bouteilles.
- Couvre pratiquement toute la bouteille, de la base au goulot.
- Mettez le housse thermique dans le congélateur avant utilisation.
- Le liquide de refroidissement n'est pas toxique.
- Pour la laver, utiliser un chiffon humide. Ne pas mettre au lave-vaisselle.

- Thermohülle kühlt und hält die Temperatur.
- Ideal um Wein oder Sekt länger temperiert zu halten.
- Passen sich perfekt an jede Flaschenart an.
- Hülle reicht vom Boden bis zum Hals praktisch ganz über die Flasche.
- Legen Sie die Thermohülle vor dem Gebrauch in den Gefrierschrank.
- Kühlmittel unbedenklich.
- Mit einem feuchten Lappen reinigen. Nicht spülmaschinengeeignet.

- Insulated cover for keeping wine or cava cool and at the perfect temperature for more time.
- Sides fit all kinds of bottles perfectly.
- It covers practically the whole bottle from the neck to the base.
- Put the thermal cover in the freezer before use.
- The coolant is non toxic.
- Use a damp cloth to clean it. Not dishwasher safe.

- Capa térmica; que permite arrefecer a garrafa e manter a temperatura.
- Ideal para manter o vinho ou espumante frios durante mais tempo.
- Adaptam-se perfeitamente a todo o tipo de garrafas.
- Cobre praticamente toda a garrafa, da base ao gargalo.
- Coloque a capa térmica no freezer antes de usar. O gel fluido refrigerante não-tóxico.
- Limpar com um pano húmido. Este artigo não é apto para máquinas de lavar louça.



## Funda enfriabotellas

Housse de refroidissement de bouteilles  
Flaschenkühler  
Bottle cooler cover  
Arrefecedor de garrafas

	Ref	€	cm	Color	U.Venta
A	62276	14,70	15x23	DENIM	1
B	62277	14,70	15x23	BLACK	1
C	62270	14,70	15x23	BURDEOS	1
D	62288	14,30	15x23	NAVY	1

Con velcro ajustable  
With adjustable velcro

Con cordón ajustable  
With adjustable drawstring



## Funda enfriabotellas

Housse de refroidissement de bouteilles  
Flaschenkühler  
Bottle cooler cover  
Arrefecedor de garrafas

	Ref	€	U.Venta
A	62325	10,60	6
B	62355	11,30	6

# Botellero NATURAL



**Asa de piel de vacuno  
acabado en curtido vegetal**  
Vegetable-tanned cow leather  
finish handle



## Botellero NATURAL

Range-bouteilles  
Flaschentasche  
Bottle rack  
Porta-garrafas

Ref	€	Ø (cm)	h (cm)	e (mm)	U.Venta
63483	22,80	10	25	0,55	1

- Fabricada en fibra virgen natural. Material ecológico y respetuoso con el medio ambiente. Lavable, resistente y duradera.
- Diseñada y fabricada en España.
- Hecha a mano. Tacto agradable y suave, similar a la piel.

- Fabriquées en fibres vierges naturelles. Matériau écologique et respectueux de l'environnement. Lavables, résistantes et durables.
- Conçues et fabriquées en Espagne.
- Faites à la main. Toucher agréable et doux, similaire au cuir.

- Aus naturreiner Faser. Umweltverträgliches Öko-Material. Waschbar, robust und langlebig.
- Design und Herstellung in Spanien.
- Handgefertigt. Weich und angenehm wie Leder.

- Made of natural virgin fibre. Ecological material respectful with the environment. Washable, resistant and durable.
- Designed and manufactured in Spain.
- Handmade. Nice soft feel, similar to leather.

- Fabricados em fibra virgem natural. Material ecológico, respeitador do meio ambiente. Laváveis, resistentes e duráveis.
- Desenhados e fabricados em Espanha.
- Fabricados à mão. Tato agradável e suave, similar ao do couro.

# Colección SOPORTES ENFRIABOTELLAS

Inox

**Solución para tener a mano las botellas de vino o champán**  
Solution to keep bottles of wine or champagne close at hand

**Compatible con:**  
Compatible with:

62315  
62320  
62322  
62321  
61321  
61319  
14121  
62365  
62362  
65418  
65420  
65618  
65620



**Robusto y estable**  
Robust and stable

**Sujeción segura y estable en cualquier mesa**  
Secure and stable hold on any table



## Pie porta-cubos

Porte-seau à champagne  
Sektkühlerständer  
Wine cooler stand  
Pé porta baldes

Ref	€	Ø (cm)	h (cm)	U.Venta
62300	90,00	20	65	1

## Soporte de mesa enfriabotellas

Support seau à champagne  
Tischhalterung für Sektkühler  
Wine cooler table support  
Suporte balde de gelo arrefecedor

Ref	€	Ø (cm)	U.Venta
62478	12,80	18	1
62479	12,90	20	1

# Colección enfriabotellas **ACRÍLICAS**



*new*

## Cubo enfriabotellas acrílico flor

Seau à vin acrylique fleur  
Champagnerkühler, Acryl, Blume  
Flower acrylic wine bucket  
Blade arrefecedora de garrafas Acrílico flor



**Práctica asa frontal y ergonómica**  
Practical and ergonomic front handle

**Acabado metalizado**  
Metallic finish



## ABS

Plastic

## Cubo enfriabotellas ARTIC

Seau à vin  
Champagnerkühler  
Vine bucket  
Balde enfria-garrafas

Ref	€	Ø (cm)	h (cm)	L	U.Venta
61331	19,60	20	25	3,50	1

## Cubo enfriabotellas doble c/asas

Seau Isotherme double avec anse  
Acryl Champagnerkühler  
Acrylic winw cooler with handle  
Blade arrefecedora de garrafas acrílico



## Cubo enfriabotellas negro

Seau à vin noir  
Acryl Champagnerkühler  
Acrylic wine bucket  
Blade arrefecedora de garrafas negro

	Ref	€	Base	Boca	h (cm)	L	U.Venta
A	62354	33,40	13,5x16	20,5x25,5	28,5	4,00	1
B	62367	34,70	16x12	27x20	20,0	3,00	1
	62368	50,00	21x15,5	35x26,5	26,0	7,00	1

## Cubo enfriabotellas doble

Seau Isotherme double  
Acryl Champagnerkühler  
Acrylic winw cooler  
Blade arrefecedora de garrafas dupla



Ref	€	Base	Boca	h (cm)	L	U.Venta
62366	40,00	13,5x18,5	21,5x30,5	26	5,50	1



## Cubo enfriabotellas

Seau à vin  
Champagnerkühler  
Vine bucket  
Blade arrefecedora de garrafas

	Ref	€	Ø (cm)	h (cm)	L	U.Venta
A	62362	12,60	22	21	3,50	1
B	62371	28,80	33	25	10,00	1

## Enfriabotellas

Seau à champagne  
Champagnerkühler  
Champaig cooler  
Arrefecedora de garrafas

Ref	€	cm	h (cm)	L	U.Venta
62373	30,30	47x29	23	13,00	1





# Colección enfriabotellas INOX

Inox  
18/10  
Dishwasher

- Amplia gama de enfriadores de botellas para el vino o champán.
- Fabricados en acero inoxidable de gran calidad.
- Ideal para uso doméstico y profesional.

- Large gamme de rafraîchisseurs de bouteilles pour le vin ou le champagne.
- Fabriqué en acier inoxydable de haute qualité.
- Idéal pour un usage domestique et professionnel.

- Große Auswahl an Flaschenkühlern für Wein oder Sekt.
- Hergestellt aus hochwertigem Edelstahl.
- Ideal für den privaten und professionellen Gebrauch.

- Wide range of bottle coolers for wine or champagne.
- Made of high quality stainless steel.
- Ideal for domestic and professional use.

- Ampla gama de refrigeradores de garrafas para vinho ou champanhe.
- Feito de aço inoxidável de alta qualidade.
- Ideal para uso doméstico e profissional.



Anilla de acero inoxidable  
Stainless steel ring

Doble pared aislante  
Acabado SOFT TOUCH  
Double insulating wall  
SOFT TOUCH finish



Se adapta a la mayoría de las botellas de vino o champán

Fits most bottles of red wine or champagne

Doble pared aislante  
Double insulating wall

Acabado en MATE  
MATT finish



## Enfriabotellas doble pared

Seau à champagne isotherme  
Champagnerkühler, isoliert  
Double champagne cooler  
Arrefecedor de garrafas parede dupla

Ref	€	Ø (cm)	Ø Int. (cm)	h (cm)	U.Venta
62356	16,50	12,5	9,50	20	1



## Enfriabotellas doble pared INOX

Seau à champagne isotherme  
Champagnerkühler  
Double champagne cooler  
Arrefecedor de garrafas parede dupla

Ref	€	Ø (cm)	h (cm)	U.Venta
62389	31,00	10,5	19,5	1

Inox

## Cubo enfriachampán oval

Seau à champagne oval  
Champagnerkühler, oval  
Oval champagne cooler  
Balde arrefecedor oval



Ref	€	cm	h (cm)	L	U.Venta
62338	82,10	30x20	20	7,00	1

## Cubo de hielo-champán LUXE asa Inox

Seau à glace-champagne "Luxe anse inox"  
Sektühler Luxe  
Wine cooler "Luxe" inox. handle  
Balde arrefecedor Luxe asa Inóx



Ref	€	Ø (cm)	h (cm)	L	U.Venta
62315	31,70	14	12,0	1,20	1
62320	43,10	20	19,0	4,50	1
62322	51,80	22	20,0	5,50	1

Inox



### Cubo de hielo

Seau à champagne  
Sektkübler  
Wine cooler  
Balde de gelo

Ref	€	Ø (cm)	h (cm)	L	U.Venta
14121	19,20	20	20	4,00	1

### Cubo enfriabotellas

Seau à vin  
Champagnerkübler  
Vine bucket  
Balde enfria-garrafas



Ref	€	Ø Sup. (cm)	Ø (cm)	h (cm)	L	U.Venta
62321	63,10	21	18	20	5,50	1

Inox



### Cubo cónico con asas soldadas

Seau à glace en inox  
Sektkübler, Rostfrei  
Stainless steel wine cooler w/welded handles  
Balde cónico Asas soldadas

Ref	€	Ø (cm)	h (cm)	L	U.Venta
61321	24,60	20	21	4,25	1

Inox



### Cubo cónico c/asas incorporadas

Seau à glace en inox  
Sektkübler, Rostfrei  
St. steel wine cooler w/fix handles  
Balde cónico Asas incorporadas

Ref	€	Ø (cm)	h (cm)	L	U.Venta
61319	26,70	20	22	4,75	1

### Champanero dorado

Refräichisseur à champagne  
Champagnerkübler  
Champagne cooler  
Champanheiro dourado



Ref	€	Ø (cm)	h (cm)	L	U.Venta
62336	131,20	36	28	11,50	1

### Champanero LUXE

Refräichisseur à champagne LUXE  
Champagnerkübler LUXE  
LUXE champagne cooler  
Champanheiro LUXE



Ref	€	Ø (cm)	h (cm)	L	U.Venta
62436	121,30	36	23	11,50	1
62439	132,40	40	26	15,00	1

### Enfriachampan

Refräichisseur à champagne  
Champagnerkübler  
Champagne cooler  
Champanheiro



Ref	€	Ø (cm)	h (cm)	L	U.Venta
62346	86,00	36	20,5	13,0	1

### Barreño oval

Bassine oval"  
Glattwanne  
Oval cooler  
Bacia oval



Ref	€	cm	h (cm)	L	U.Venta
62271	58,20	43x30	20	20,00	1
62272	70,10	53x38	25	27,00	1
62273	82,00	61x43	28	32,00	1

# Colección MOON

Inox  
18/10



## Asa de piel de vacuno acabado en curtido vegetal

Vegetable-tanned cow leather finish handle

- Cuerpo de Acero inoxidable 18/10, resistente a la corrosión.
- Diseño elegante y actual.
- Muy cómodo y fácil de desplazar gracias a su asa de cuero.
- Asa de piel vacuno acabado en curtido vegetal de 3 mm de grosor.
- Acabado exterior negro mate e interior lijado o exterior e interior lijado.

- Corps en acier inoxydable 18/10, résistant à la corrosion.
- Style élégant et actuel.
- Très pratique et facile à déplacer grâce à sa anse en cuir.
- Anse en peau de vachette avec un tannage végétal de 3 mm d'épaisseur.
- Finition extérieur noir mat et intérieur brossé ou extérieur et intérieur brossé.

- Körper aus Edelstahl 18/10, korrosionsbeständig.
- Elegantes und aktuelles Design.
- Dank der beiden Ledergriffe sehr bequem und einfach zu handhaben.
- Griff aus pflanzlich gegerbtem Rindsleder, 3 mm dick.
- Außen mattschwarz und innen poliert oder außen und innen poliert.

- 18/10 corrosion resistant stainless steel body.
- It has an elegant and modern design.
- Leather handles make it very easy and comfortable to move around.
- The handle has a 3 mm thick vegetable-tanned cow leather finish.
- Matte black outside and brushed inside or brushed inside and outside.

- Em aço inoxidável 18/10, resistente à corrosão.
- Design elegante e atual.
- Prática e fácil de mover, graças à asa de couro.
- Asa em pele de bovino com acabamento em curtido vegetal de 3 mm de espessura.
- Acabamento exterior negro mate e interior polido, e acabamento exterior e interior polido.

## Cubitera MOON BLACK

Seau à glace  
Sektkübler  
Ice bucket  
Porta-cubos de gelo



## Cubitera MOON INOX

Seau à glace  
Sektkübler  
Ice bucket  
Porta-cubos de gelo



Ref	€	Ø (cm)	h (cm)	L	U.Venta
65414	40,00	14	12	1,5	1

Ref	€	Ø (cm)	h (cm)	L	U.Venta
65614	34,60	14	12	1,5	1

## Enfriabotellas MOON BLACK

Seau à champagne  
Champagnerkübler  
Wine bucket  
Arrefecedora de garrafas



## Enfriabotellas MOON INOX

Seau à champagne  
Champagnerkübler  
Wine bucket  
Arrefecedora de garrafas



Ref	€	Ø (cm)	h (cm)	L	U.Venta
65418	47,40	18	19,0	4,0	1
65420	56,60	20	19,5	5,6	1

Ref	€	Ø (cm)	h (cm)	L	U.Venta
65618	43,80	18	19,0	4,0	1
65620	52,60	20	19,5	5,6	1



### Champanero MOON BLACK

Refräichisseur à champagne  
Champagnerkühler  
Champagne cooler  
Champanheiro

Ref	€	Ø (cm)	h (cm)	L	U.Venta
65436	120,30	36	20,5	11,5	1



### Champanero MOON INOX

Refräichisseur à champagne  
Champagnerkühler  
Champagne cooler  
Champanheiro

Ref	€	Ø (cm)	h (cm)	L	U.Venta
65636	120,30	36	20,5	11,5	1

Más visibilidad y accesibilidad  
More visibility and accessibility



Más visibilidad y accesibilidad  
More visibility and accessibility



### Champanero inclinado MOON BLACK

Refräichisseur à champagne incliné  
Schräger Champagnerkühler  
Inclined champagne cooler  
Champanheiro inclinado

Ref	€	Ø (cm)	h (cm)	L	U.Venta
65440	119,10	40	27	15	1

### Champanero inclinado MOON INOX

Refräichisseur à champagne incliné  
Schräger Champagnerkühler  
Inclined champagne cooler  
Champanheiro inclinado

Ref	€	Ø (cm)	h (cm)	L	U.Venta
65640	119,10	40	27	15	1



### Barreño MOON BLACK

Bassine  
Glattwanne  
Mirror cooler  
Bacia

Ref	€	Ø (cm)	h (cm)	L	U.Venta
65450	105,40	50	21	30	1



### Barreño MOON INOX

Bassine  
Glattwanne  
Mirror cooler  
Bacia

Ref	€	Ø (cm)	h (cm)	L	U.Venta
65650	105,40	50	21	30	1



## 61952-61953

- Perfecta para bebidas calientes o frías como limonadas, té, sangría, leche, etc.
- Ideal para llevar las bebidas a la mesa o guardarlas en la nevera.
- Gran apertura que facilita su llenado y su limpieza.
- Cuerpo apto para el lavavajillas.

## 61952-61953

- It's perfect for hot or cold drinks, like lemonade, tea, sangria or milk.
- It's ideal for bringing drinks to the table or keeping them in the refrigerator.
- Its large opening makes it easy to fill and clean.
- The body is dishwasher safe.

## 61951

- Perfecta para bebidas frías como agua, limonada, zumo, sangría, etc.
- Grifo integrado para servir la cantidad de bebida deseada directamente en el vaso.
- Ideal para buffet, área de reuniones, recepciones de hoteles, etc.
- Gran apertura que facilita su llenado y su limpieza.

## 61951

- Ideal für Wasser, Limonade, Saft, Sangria und andere Kaltgetränke.
- Mit integriertem Hahn zum Ausschöpfen der gewünschten Menge direkt in ein Glas.
- Ideal für Buffets, Konferenzräume, Hotelpflicht usw.
- Großer Auslass, einfache Befüllung und Reinigung.

**Tapa extraíble con cierre hermético**  
Removable lid with hermetic closure

**Pico vertedor para evitar derrames**  
spout to prevent spills

**Resistente a los choques térmicos**  
Resistant to thermal shock



**Tapa con doble posición**  
**Filtro-colador integrado en la tapa (2)**  
el hielo, las hierbas aromáticas o la fruta es retenida en el vertido.

Double position lid  
Filter-strainer integrated in the lid (2). Ice, aromatic herbs or fruit is held in place while pouring

**Inox 18/10**  
Tapa/Lid

## Jarra FRESH

Pot à eau  
Wasserkanne  
Water jug  
Jarra

Ref	€	cm	h (cm)	L	U.Venta
61952	16,20	14x9,2	27,3	1,70	1

**Tapa extraíble con cierre hermético**  
Removable lid with hermetic closure

**Pico vertedor para evitar derrames**  
spout to prevent spills

**Resistente a los choques térmicos**  
Resistant to thermal shock



**Tapa de acero con cierre hermético**  
Steel lid with a hermetic seal

**Gran apertura. Llenado más fácil**  
Grand opening. Easier filling

**Cristal**  
Glass

**Grifo integrado**  
Integrated faucet



## Jarra SEA

Pot à eau  
Wasserkanne  
Water jug  
Jarra

## Jarra dispensadora

Pichet distributeur de boissons  
Getränkspender  
Serving pitcher  
Jarra dispensadora

Ref	€	cm	h (cm)	L	U.Venta
61953	15,00	13,8x8,5	22,8	1,00	1

Ref	€	cm	h (cm)	L	U.Venta
61951	22,20	18x23	30,5	5,50	1

**A FE**  
Hierro/Iron

**Resistente y duradero**  
Strong and durable

**Alambre de acero. Acabado en negro mate**  
Steel wire. Matte black finish



**B Bambú**  
Bamboo

**Resistente y duradero**  
Strong and durable



**Soporte para jarra dispensadora**

support pur pichet distributeur de boissons  
Unterstützung für Getränkspender  
Support for serving pitcher  
Soporte para jarra dispensadora

	Ref	€	Ø (cm)	h (cm)	U.Venta
A	61955	7,70	19,5	18,5	1
B	61956	13,20	21,0	14,5	1



**Tapa antiderrames**  
Non-spill lid

**Filtro infusor en el centro para frutas y verduras**  
Infusion filter in the centre for fruits and vegetables



**MS Plastic**  
Cuerpo / Corp

**PP Polypropylene**  
Tapa / Lid

**Jarra infusora**

Pichet infuseur  
Tee-Zubereiter  
Infusion pitcher  
Jarra infusionadora

Ref	€	cm	L	U.Venta
61954	30,80	19x16x29	2,40	1



**Desenroscar la tapa girándola en sentido anti-horario.**

Dévisser le couvercle dans le sens inverse des aiguilles d'une montre.  
Deckel im Gegenzeigersinn abschrauben.  
Unscrew the lid by turning it counter-clockwise.  
Desenroscar a tampa girando-a no sentido anti-horário.



**Introducir la fruta, hierbas o semillas.**

Mettre de fruit, les herbes ou les graines.  
Geschnittenes Obst, Kräuter oder Samen hinein geben.  
Introduce the fruit, herbs or seeds.  
Introduzir a fruta, ervas ou sementes.



**Enroscar la tapa girándola en sentido horario.**

Revisser le couvercle en le faisant tourner dans le sens des aiguilles d'une montre.  
Deckel im Uhrzeigersinn einschrauben.  
Screw on the lid by turning it clockwise.  
Enroscar a tampa girando-a no sentido horário.



**Introducir el filtro dentro de la jarra y presionar la tapa hasta cerrarla.**

Introduire le filtre dans le pichet et appuyer sur le couvercle jusqu'à sa fermeture.  
Filter in das Gefäß einführen und Deckel zum Schließen herunter drücken.  
Put the filter in the pitcher and push the lid until it's closed.  
Introduzir o filtro no interior da jarra, e pressionar a tampa até fechá-la.

**Inox 18/10**



**Inox 18/10**



**Inox 18/10**



**Jarra**

Pot à eau  
Wasserkanne  
Water jug  
Jarra

Ref	€	Ø (cm)	L	U.Venta
62716	25,30	12x16	1,50	1
62721	27,90	12x23	2,00	1
62726	32,20	12x26,5	2,50	1

**Jarra con retén**

Pot à eau avec retenu  
Wasserkanne mit Schnaupe  
Water jug with ice guard  
Jarra com retentor

Ref	€	Ø (cm)	L	U.Venta
62715	29,40	12x16	1,50	1
62720	30,70	12x23	2,00	1
62725	34,70	12x26,5	2,50	1

**Jarra bombada con retén**

Pot à eau bombée avec retenu  
Kanne mit Schnaupe  
Rounded water jug with ice guard  
Jarra bojuda com retentor

Ref	€	L	U.Venta
62702	47,90	2,00	1

**ASA**



Acrylic

**Jarra con tapa**

Pot avec couvercle  
Acrylkrug mit Deckel  
Pitcher with lid  
Jarra com Tampa

Ref	€	L	U.Venta
62391	36,20	2,80	1



**ASA**



Acrylic

**Jarra de agua**

Pot à verser  
Acrylkrug  
Water pitcher  
Jarra

Ref	€	L	U.Venta
62392	13,90	2,00	1
62393	17,60	3,00	1



# Colección vasos TRITÁN



- Fabricados en trítan transparente libre de BPA; material muy resistente que soporta altas temperaturas.
- Ligeros, versátiles y a prueba de roturas, perfectos para espacios exteriores donde la seguridad es importante.
- Para servir y disfrutar todo tipo de bebidas en cualquier ocasión.
- Su gran parecido visual al vidrio hace que sea sutil, elegante y de calidad, como un vaso de vidrio.
- Reutilizables, irrompibles y aptos para el lavavajillas.

- Fabriqués en Tritan transparent sans bisphénol A ; matériau très résistant qui supporte des températures élevées.
- Légers, versatiles et à l'épreuve de la casse, ils sont parfaits pour des espaces extérieurs où la sécurité est importante.
- Pour servir et déguster tout type de boisson en toute occasion.
- Leur grande ressemblance visuelle avec le verre les rend subtils, élégants et de qualité, tel un authentique verre.
- Réutilisables, incassables et aptes pour le lave-vaisselle.

- Hergestellt aus BPA-freiem, durchsichtigem Tritan, ein hochfestes Material, das hohen Temperaturen standhält.
- Leicht, vielseitig einsetzbar und bruchfest, perfekt für sicherheitsrelevante Außenbereiche.
- Um beliebige Getränke zu jedem Anlass zu genießen.
- Seine große Ähnlichkeit mit Glas verleiht ihm Raffiniertheit, Eleganz und Qualität, wie ein Kristallglas.
- Wiederverwendbar, unzerbrechlich und Spülmaschinen geeignet.

- Manufactured in transparent BPA-free Tritan; high strength material that can withstand high temperatures.
- Lightweight, versatile and break-proof, perfect for outdoor areas where safety is important.
- To serve and enjoy all types of drinks for any occasion.
- With its subtle, elegant and quality material, it provides a great visual resemblance to glass.
- Reusable, unbreakable and dishwasher safe.

- Fabricados em Tritan transparente, sem BPA. Material muito resistente, que suporta temperaturas elevadas.
- Leves, versáteis e à prova de roturas, ideais para espaços exteriores onde a segurança é importante.
- Para servir e desfrutar de todo o tipo de bebidas, em qualquer ocasião.
- O seu grande parecido visual com o vidro converte-o num acessório.
- Reutilizáveis, irreversíveis e aptos para as lavavajillas.

## Set 6 vasos de hisky

Set 6 verres à whisky  
Set 6 Whisky-gläser  
Set of 6 whisky glasses  
Conjunto de 6 copos whisky



Ref	€	Ø (cm)	h (cm)	ml	U.Venta
63141	33,00	8,5	9,5	400	1

## Set 6 vasos de cerveza

Set 6 verres à bière  
Set 6 Biergläser  
Set of 6 beer glasses  
Conjunto de 6 copos cerveja



Ref	€	Ø (cm)	h (cm)	ml	U.Venta
63142	58,20	8	22,5	700	1

**Aptos para todos los soportes de copas LACOR**  
Suitable for all LACOR cup holders

## Set 6 copas de vino blanco

Set 6 verres à vin blanc  
Set 6 Weisweingläser  
Set of 6 white wine glasses  
Conjunto de 6 cálices vinho branco



Ref	€	Ø (cm)	h (cm)	ml	U.Venta
63143	45,30	7	20	350	1

**Aptas para todos los soportes de copas LACOR**  
Suitable for all LACOR cup holders



### Set 6 copas de vino tinto

Set 6 verres à vin rouge  
Set 6 Rotweingläser  
Set of 6 red wine glasses  
Conjunto de 6 cálices vinho tinto

Ref	€	Ø (cm)	h (cm)	ml	U.Venta
63144	51,40	9,5	21	500	1



### Set 6 vasos de refresco

Set 6 verres à eau  
Set 6 Gläser  
Set of 6 soft drink glasses  
Conjunto de 6 copos refresco

Ref	€	Ø (cm)	h (cm)	ml	U.Venta
63145	66,80	8,5	14,5	500	1



### Set 6 jarra de cerveza

Set 6 chopes à bière  
Set 6 Bierkrüge  
Set of 6 beer tankards  
Conjunto de 6 jarras cerveza

Ref	€	Ø (cm)	h (cm)	ml	U.Venta
63146	61,90	8,5	14	500	1



### Set 6 vasos de agua

Set 6 verres à eau  
Set 6 Wassergläsern  
Set of 6 water glasses  
Conjunto de 6 copos água

Ref	€	Ø (cm)	h (cm)	ml	U.Venta
63147	48,90	8,0	10	350	1

**Aptas para todos los soportes de copas LACOR**  
Suitable for all LACOR cup holders



### Set 6 vasos de niño

Set 6 verres enfant  
Set 6 Kinderbrillen  
Set of 6 child glasses  
Conjunto de 6 copos criança

Ref	€	Ø (cm)	h (cm)	ml	U.venta
63148	35,00	6,5	11	300	1



### Set 6 copas de champán

Set de 6 flutes à champagne au lieu de coupes  
Set 6 Gläsern Champafner  
Set of 6 champagne glasses  
Conjunto de 6 copos champante

Ref	€	Ø (cm)	h (cm)	ml	U.Venta
63149	51,00	4,5	22,5	150	1

**MF**

Melamine

70°C  
-20°C



**Inox**  
18/10

### Vaso INOX

Timbale  
Trinkbecher  
Tumbler  
Copo



Ref	€	Ø (cm)	L	U.Venta
62406	6,00	7,5x10	0,30	20

White  
A



Black  
B



### Vaso

Timbale  
Trinkbecher  
Tumbler  
Copo

	Ref	€	Ø (cm)	h (cm)	L	U.Venta
A	63350	3,40	7,3	7,7	0,32	1
B	63351	3,40	7,3	7,7	0,32	1



# Colección SOPORTES COPAS · TAZAS

**FE** Cromado

Hierro/iron Chrome

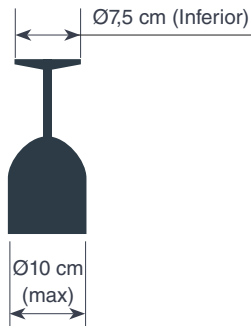
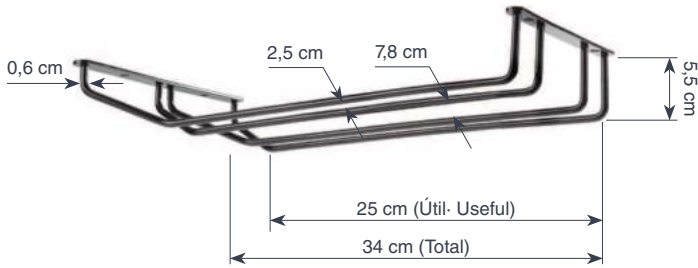

- Soporte que permite ahorrar espacio y almacenar las copas de forma ordenada.
- Se fija a la parte superior de un mueble, techo o cornisa permitiendo colocar las copas boca abajo y facilitando accesibilidad de las mismas.
- Desliza las copas muy fácilmente evitando que se marquen y que se rompan.

- Support qui permet un gain de place et un rangement des verres à pied de façon ordonnée.
- Se fixe à la partie supérieure d'un meuble, d'un plafond ou d'une corniche, permettant ainsi de ranger les verres à pied vers le bas et faciliter leur accès.
- Fait glisser les verres très facilement en évitant qu'ils soient marqués et qu'ils se cassent.

- Platzsparender und Ordnung schaffender Gläserhalter.
- Wird unter Möbeln, Decken oder Simsen angebracht. Gläser werden kopfüber eingehängt und lassen sich leicht heraus nehmen.
- Lässt Gläser mühelos herausgleiten, ohne Streifen oder Bruch zu verursachen.

- With this rack, you can save space and store glasses in an organised way.
- It can be attached to the top of a piece of furniture, ceiling or moulding where the glasses are placed upside down for easy access.
- The glasses slide easily so they won't get scratched or broken.

- Suporte que permite economizar espaço e armazenar os cálices de maneira ordenada.
- Fixa-se à parte superior de qualquer móvel, teto ou cornija, permitindo colocar os cálices virados para baixo, facilitando o acesso aos mesmos.
- Os cálices deslizam facilmente no suporte, evitando assim que se partam, ou deixar quaisquer marcas nos mesmos.



Øvarilla · Rod = 6 mm

## Soporte de copas

Support à coupes  
Gläserhalter  
Cups stand  
Suporte de tapas

	Ref	€	cm	h (cm)	U.Venta
A	62261	14,90	34x10	6	1
B	62262	21,80	34x20	6	1
C	62263	33,50	34x40	6	1



Øvarilla · Rod = 6 mm

## Soporte de copas BLACK

Support à coupes  
Gläserhalter  
Cups stand  
Suporte de tapas

	Ref	€	cm	h (cm)	U.Venta
A	62264	17,30	34x10	6	1
B	62265	26,60	34x20	6	1
C	62266	37,40	34x40	6	1

### Almacena hasta 6 copas

Stores up to six glasses



Recubrimiento de silicona  
Silicone coating

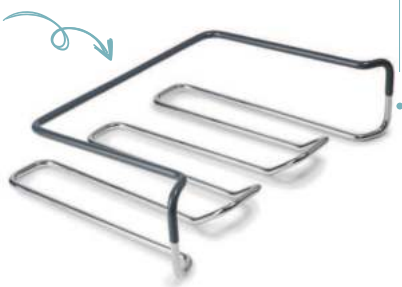

Øvarilla · Rod = 6 mm

### Rack para copas

Support pour verres à pied  
Gläserhalter  
Glass rack  
Rack para copos

Ref	€	cm	Copas	U.Venta
62267	18,10	31x21	6	1

- Se adapta a cualquier estante, armario de cocina o comedor.
- No requiere instalación, se puede mover o cambiar fácilmente de sitio.
- Es estable y no raya las superficies.
- Versátil, apto para todo tipo de copas. Almacena hasta seis copas.
- Aprovecha al máximo el espacio de tus estantes.

- Il s'adapte à tout type d'étagère, armoire ou vaisselier.
- Il ne nécessite aucune installation, peut facilement être déplacé ou changé d'endroit.
- Il est stable et ne raye pas les surfaces.
- Versatile, il est valable pour tout type de verres à pied. Peut contenir jusqu'à six verres à pied.
- Exploitez au maximum l'espace de vos étagères.

- Fits any shelf, kitchen or dining room cabinet.
- No installation required. Can be moved easily from one place to another.
- The rack is stable and does not scratch surfaces.
- Versatile, suitable for all types of glasses. Stores up to six glasses.
- Make the most of your shelf space.

Øvarilla · Rod = 6 mm

### Soporte de copas

Support à coupes  
Gläserhalter  
Cups stand  
Suporte de tapas

Ref	€	cm	h (cm)	U.Venta
62268	18,70	45x32	6,0	1

Capacidad  
Copas  
Wine  
Glasses  
Capacity  
**20**

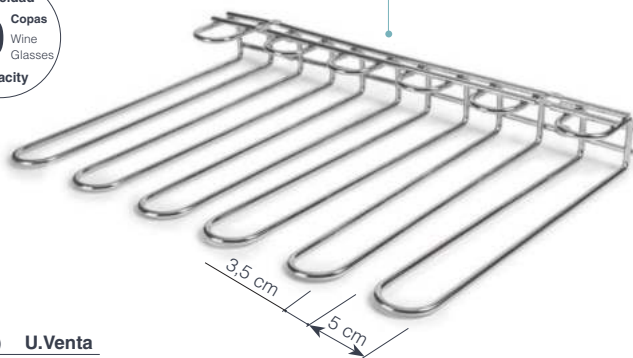

### Posibilidad de fijación en techo o pared

Can be fastened to a ceiling or wall



Fijado al techo  
Fastened to ceiling



Fijado a la pared  
Fastened to wall

- Fabricado en acero cromado de máxima calidad y ultraresistente.
- Tratamiento antióxido.
- Diseñado para optimizar el espacio y organizar las baldas, estanterías y los armarios.
- Muy fácil de instalar: incluye dos refuerzos para una sujeción más segura.

- Fabriqué en acier chromé de la plus grande qualité et ultrarésistant.
- Traitement anti-rouille.
- Conçu pour optimiser l'espace et organiser les étagères et les placards.
- Très facile à installer : inclut deux renforts pour une fixation plus sûre.

- Made of top quality ultra strong chromed steel
- Anti rust treatment.
- Designed to optimise space and organise shelves and cupboards.
- Very easy to install: includes two braces for more secure attachment.



### Estantes de hasta 2 cm de grosor

Shelves up to 2 cm thick

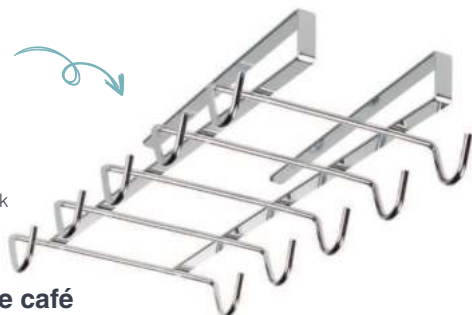

### Colgador tazas de café

Support des tasses à café  
Aufhänger für Kaffeetassen  
Holder for coffee cups  
Suporte de copos de café

Ref	€	cm	Tazas	U.Venta
62269	10,40	28x14x6	10	1

Almacena hasta 6 botellas  
Stores up to six bottles

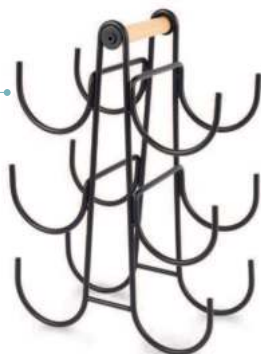

### Botellero

Casier à vin  
Weinregal  
Vine rack  
Cremalheira do vinho

Ref	€	cm	h (cm)	ØVarilla (mm)	U.Venta
61141	36,80	26,6x14	37,5	4	1

- Original botellero muy decorativo fabricado en alambre de acero, acabado en negro mate. Resistente y duradero.
- Corbeilles à casier à vin original et décorative fabriquée en fil d'acier avec une finition noire mate. Résistante et durable.
- Originelles und sehr dekoratives Weinregal aus Stahldraht mit mattschwarzer Oberfläche. Haltbar und strapazierfähig.
- Highly decorative original vine rack made of steel wire with a matte black finish. Resistant and durable.
- Original cremalheira decorativo, fabricado em arame de aço, acabamento preto mate. Resistentes e duráveis.



# Juegos utensilios **COCTELERÍA**

new

Inox  
18/10

Inox

PP

Polypropilene



10  
pcs

- Todas las piezas fabricadas en acero inoxidable de gran calidad, tapón de aleación de zinc y soporte de bambú 100% natural (62181).
- Todas las piezas fabricadas en acero inoxidable de gran calidad en acabado cobre (62182).
- Indispensable tanto para profesionales como para aficionados.
- Mantiene todas las herramientas organizadas y elegantemente mostradas (62181). Diseño portátil.
- Ideal para preparar fácilmente todo tipo de cócteles.
- Piezas fáciles de limpiar.

- Toutes les pièces sont fabriquées en acier inoxydable de grande qualité, avec un bouchon en alliage de zinc et un support en bambou 100% naturel (62181).
- Toutes les pièces sont fabriquées en acier inoxydable de grande qualité avec une finition cuivrée (62182).
- Indispensable aussi bien pour les professionnels que pour les amateurs.
- Maintient tous les ustensiles rangés et élégamment disposés (62181). Transportable.
- Idéal pour préparer facilement tout type de cocktails.
- Pièces faciles à nettoyer.

- Alle Teile aus hochwertigem Edelstahl, Deckel aus Zinklegierung und Halter aus 100 % natürlichem Bambusholz (62181).
- Alle Teile aus hochwertigem Edelstahl in Kupferoptik (62182).
- Must-have für Profis und Cocktail-Fans.
- Ordentliche und elegante Präsentation (62181). Tragbar.
- Ideal zum mühelosen Mixen aller möglichen Cocktails.
- Teile sind einfach zu reinigen.

- All parts made of top quality stainless steel; includes a zinc alloy cap and 100% natural bamboo stand (62181).
- All parts made of top quality stainless steel in copper finish (62182).
- A must for professionals and amateurs alike.
- Keeps all utensils neatly organised and elegantly displayed (62181). Portable design.
- Perfect for making all types of cocktails.
- Easy to clean parts.

- Todas as peças são fabricadas em aço inoxidável de grande qualidade. Tampão de liga de zinco e suporte de bambu 100% natural (62181).
- Todas as peças são fabricadas em aço inoxidável de grande qualidade (62182).
- Indispensável para profissionais e amadores.
- Conserva todos os utensílios organizados e elegantemente expostos (62181). Design portátil.
- Ideal para preparar facilmente todo o tipo de cocktails.
- Todos os utensílios são fáceis de limpar.



8  
pcs

## Compuesto por:

- A Cucharilla cocktail
- B Coctelera
- C Maza mojito
- D Colador gusanillo
- E Pinza
- F Dosificador licor
- G Dos boquillas servidoras

## Compuesto por:

- A Cucharilla cocktail
- B Coctelera
- C Maza mojito
- D Colador gusanillo
- E Sacacorchos
- F Dosificador licor
- G Pinza
- H Tapón
- I Dos boquillas servidoras
- J Soporte



## Juego coctelería INOX

Ensemble pour cocktails  
Cocktail-Utensilien  
Cocktail Set  
Conjunto para preparar cocktails

Ref	€	Piezas	L (Coctelera)	ml (Medidor)	cm (Cuchara)	U.Venta
62181	59,80	10	0,55	15 / 30	26	1

## Juego coctelería INOX COBRE

Ensemble pour cocktails  
Cocktail-Utensilien  
Cocktail Set  
Conjunto para preparar cocktails

Ref	€	Piezas	L (Coctelera)	ml (Medidor)	cm (Cuchara)	U.Venta
62182	56,00	8	0,55	15 / 30	26	1

# Colección CÓCTEL

Inox  
18/10



Dishwasher



- Todo lo necesario para preparar deliciosos cócteles.
- Ideal para profesionales de la coctelería.
- Podrá encontrar cocteleras, pinzas para hielo, vasos medidores, cucharas de bar, etc.
- Fabricados en acero inoxidable de alta calidad.

- Tout ce dont vous avez besoin pour préparer de délicieux cocktails.
- Idéal pour les mixologues professionnels.
- Vous pouvez trouver des shakers, pinces à glace, verres à mesurer, cuillères de bar, etc.
- Fabriqué en acier inoxydable de haute qualité.

- Alles, was Sie brauchen, um köstliche Cocktails zuzubereiten.
- Ideal für professionelle Mixologen.
- Sie finden Cocktailshaker, Eiszangen, Messgläser, Barlöffel usw.
- Aus hochwertigem Edelstahl.

- Everything you need to prepare delicious cocktails.
- Ideal for professional mixologists.
- You can find cocktail shakers, ice tongs, measuring glasses, bar spoons, etc.
- Made of high quality stainless steel.

- Tudo que você precisa para preparar deliciosos coquetéis.
- Ideal para mixologistas profissionais.
- Você pode encontrar coquetéis, pinças de gelo, copos de medida, colheres de bar, etc.
- Fabricado em aço inoxidável de alta qualidade.



## TPE

plastic

### Tapete Coctelería

Tapis égouttoir  
Cocktail-Matte  
Cocktail mat  
Tapete para cocktails

	Ref	€	cm	h (cm)	U.Venta
A	62626	17,40	45x30	1,80	20
B	62627	10,70	30x15	1,80	20
C	62628	10,70	60x8	1,80	20



Perfecto para organizar utensilios y accesorios de coctelería y bar como servilletas, pajitas, adornos, etc.  
Perfect for organising cocktail utensils and accessories and bar such as napkins, straws and decorations

Puede contener aproximadamente 100 servilletas de 12x12 cm

It holds around 100 12x12 cm cocktail napkins

6 compartimentos  
6 compartments



### Organizador de accesorios cóctel

Organisateur pour accessoires de cocktail  
Organizer für Cocktailzubehör  
Cocktail accessory organiser  
Organizador de acessórios para cocktails

Ref	€	cm	h (cm)	Compartimentos	U.Venta
62438	9,40	24x14	10	6	1



Ideal para dar un toque especial a los cócteles. Consigue un efecto de hielo o escarcha  
Perfect for adding a special touch to your cocktails. Create a frosty or icy effect.

3 compartimentos bien identificados  
3 well-identified compartments

Almohadilla para zumo  
Pad for juice



### Ribeteador de copas y vasos

Sucreur/saleur bordeur de verres  
Umranden für Cocktailgläser  
Glass rimmer  
Decorador de copos e taças

Se pliega para un fácil almacenamiento  
Foldable for easy storage

Ref	€	cm	h (cm)	Bandejas	U.Venta
62414	13,90	20x16	7,5	3	1

Queda herméticamente cerrada cuando el vaso de metal se contrae por el efecto del frío (62285-62286)

The second glass is hermetically sealed when the metal glass contracts because of the cold (62285-62286)

Vidrio  
Glass  
500 ml

Acero inoxidable  
Stainless steel  
800 ml



Inox  
Vidrio  
Glass

### Coctelera BOSTON INOX

Agitateur  
Cocktailshaker  
Cocktail shaker  
Agitador

Ref	€	Ø (cm)	h (cm)	U.Venta
62285	13,90	8	16	1

Vidrio  
Glass  
500 ml

Acero inoxidable  
Stainless steel  
800 ml



Inox  
Vidrio  
Glass

### Coctelera BOSTON COPPER

Agitateur  
Cocktailshaker  
Cocktail shaker  
Agitador

Ref	€	Ø (cm)	h (cm)	U.Venta
62286	18,20	8	16	1

### Coctelera tapón Inox

Shaker avec bouchon inox  
Cocktailshaker, mit Edelstahl Verschluss  
Cocktail shaker st. steel lid  
Shaker tampa Inóx

Ref	€	L	U.Venta
62303I	50,80	0,50	1
62304I	60,30	0,75	1



### Coctelera acrílica con tapón Inox

Shaker acrylique avec bouchon Inox  
Coctailshaker, Acryl, mit Verschluss  
Acrylic cocktail shaker with st steel cap  
Shaker acrílica com tampa em Inóx

Ref	€	Ø (cm)	h (cm)	L	U.Venta
62388	20,60	9	22,5	0,45	1





### Cubitera NORDIC

Seau à glace  
Sekkühler  
Ice bucket  
Porta-cubos gelo

Ref	€	Ø (cm)	h (cm)	L	U.Venta
65514	32,00	14	14,5	1,30	1

- Cuerpo fabricado en acero inoxidable de máxima calidad. Acabado mate.
- Doble pared aislante: aísla el hielo de la temperatura ambiente y lo mantiene sólido durante más tiempo. Evita la condensación exterior.
- Incluye tapa 100% de bambú natural y pinza para el hielo de acero inoxidable 18/10.
- Ideal para cubitos de hielo o hielo picado.
- Fácil de transportar: práctica y cómoda asa de acero inoxidable.

- Corps fabriqué en acier inoxydable de la plus grande qualité. Finition mate.
- Double paroi isolante : isole la glace de la température ambiante et la maintient solide plus longtemps. Évite la condensation extérieure.
- Inclut un couvercle 100% en bambou naturel et une pince à glaçons en acier inoxydable 18/10.
- Idéal pour les glaçons ou la glace pilée.
- Facile à transporter : poignée pratique en acier inoxydable.

- Made of top quality stainless steel. Matte finish.
- Double wall insulation: insulates the ice from the room temperature and keeps it solid for longer.
- Prevents external condensation.
- Includes 100% natural bamboo lid and 18/10stainless steel ice tongs.
- Ideal for ice cubes or crushed ice.
- Easy to carry: practical and comfortable stainless steel handle.



### Cubitera doble pared con pinza + tapa

Seau à glace isotherme acrylique a/pince + couvercle  
Sekkühler, Isoliert, Acryl m/Eiszange + Deckel  
Acrylic double wall ice bucket with tong + lid  
Porta-cubos gelo parede dupla acrílico compinça + tampa

Ref	€	Ø (cm)	h (cm)	L	U.Venta
62363	25,80	20	21	3,00	1



### Picadora de hielo manual

Broyeur à glace manuel  
Manuel Eis-Crusher  
Manual ice crusher  
Picadora de gelo manual

Ref	€	cm	h (cm)	U.Venta
60327	49,30	16x23	12	1

Inox

### Pinza hielo LUXE

Pince à glace  
Eiszange  
Ice tong  
Pinça de gelo



Ref	€	L (cm)	U.Venta
62337	9,90	20	12

### Pinza hielo

Pince à glace  
Eiszange  
Ice tong  
Pinça de gelo



Ref	€	L (cm)	U.Venta
62306	4,60	18,5	12

Inox  
18/10

### Librador

Pelle à farine  
Mehlschaufel  
Ice shovel  
Corredor



Ref	€	ml	L (cm)	A (cm)	U.Venta
67012	17,40	60	19,0	5,0	6
67013	20,30	110	21,5	6,0	6
67014	23,90	200	24,0	7,0	6
67016	26,60	260	25,5	8,5	1
67017	29,50	360	29,0	10,0	6
67018	31,80	470	31,0	11,0	6
67019	39,60	640	35,0	12,5	6
67020	47,40	860	38,0	14,0	6



### Librador

Pelle à farine  
Mehlschaufel  
Ice shovel  
Corredor

	Ref	€	ml	Mango (cm)	U.Venta
A	67021	5,70	170	12	1
B	67022	11,60	900	12	1
C	67023	15,90	1800	14	1



### Botella sifón CO2

Bouteille siphon  
Soda-Siphon  
Soda maker bottle  
Garrafa armadilha

Ref	€	Ø (cm)	L	U.Venta
68601	54,90	10x39	1,00	1



- Carga de CO2 para botellas de sifón.
- Una carga de apróx. 8 gr = 1Lt de soda.
- Un solo uso.
- Se suministra en caja de 10 unidades.

- Charge de CO2 pour bouteilles de siphon
- Pour un litre de soda, charger environ 8 gr.
- Un seul usage.
- Fourni en boîte de 10 unités.

- Loading CO2 in bottles with siphons.
- An (approximately) 8g load is sufficient for 1 l of soda.
- Single use.
- Supplied in 10-unit boxes



### Cargas para botellas sifón CO2

Cartuches CO2 pour siphon  
CO2 -Kapseln für Siphon  
CO2 soda charges  
Botijas de sifão CO2



Ref	€	Botellas	g	U.Venta
68602	8,00	10	8	1

### Colador gusanillo

Passoire à cocktail  
Cocktailsieb  
Cocktail strainer  
Coador batidos



Ref	€	U.Venta
62326	23,60	1

PP

Polypropilene



### Maza negra mojito

Pilon noir mojito  
Mojitostößel  
Black mace mojito  
Maço preto mojito



Ref	€	L (cm)	U.Venta
62278	11,20	18	1
62279	12,70	26	1

Inox  
18/10

### Servidor revolver para 4 botellas

Serviteur pivotant pour boissons 4 cl  
Getränk-Servierer, "Revolver", mit Fuss, 4 cl  
Drinks revolver server w/stand 4 cl  
Servidor revólver para 4 garrafas



Ref	€	L	U.Venta
62341	92,70	4 cl	1

### Dosificador licor DUAL

Mesure à cocktail  
Cocktailmass  
Jigger  
Dosificador licor



Ref	€	h (cm)	cl	U.Venta
62329	21,80	9,7	2-2,5 / 4-5	1

### Dosificador licor

Mesure à cocktail  
Cocktailmass  
Jigger  
Dosificador licor



Ref	€	cl	U.Venta
62330	20,10	2/4	1

### Cucharilla cocktail

Cuillère cocktail  
Bartlöffel  
Cocktail spoon  
Colher cocktail



Ref	€	L (cm)	U.Venta
62302	4,70	27	6

### Cucharilla cocktail rizada

Cuillère cocktail cannelée  
Bartlöffel, gewellter  
Cocktail long spoon  
Colher cocktail frizada



Ref	€	L (cm)	U.Venta
62352	8,10	28	6

## ABREBOTELLAS pared

Aleación  
de zinc

Zinc alloy

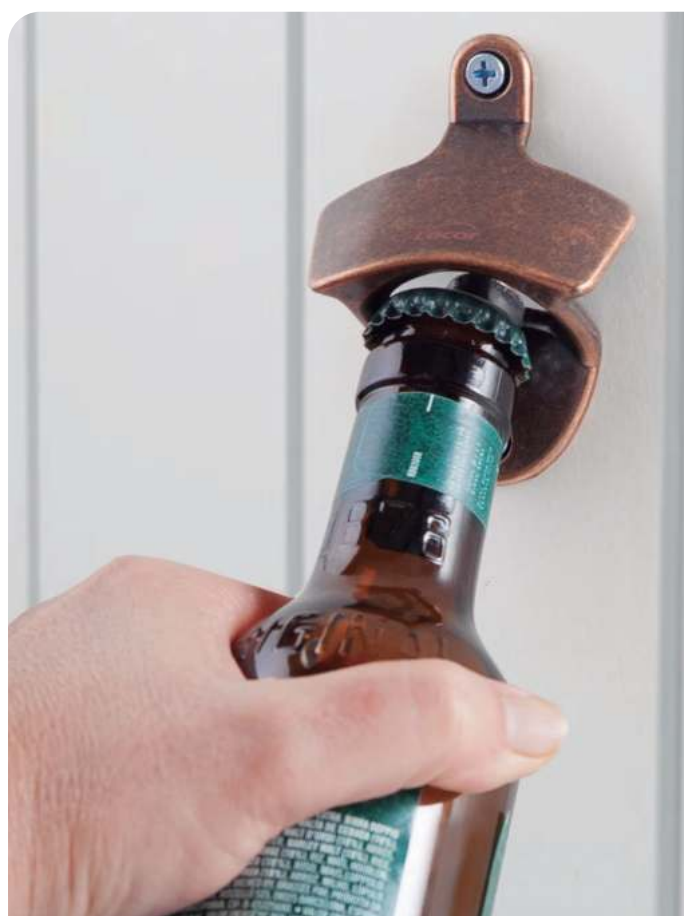

- Robusto y resistente.
- Fácil de montar, se fija en la pared (tornillos incluidos).
- Fácil apertura con una sola mano.

- Robuste et résistant.
- Facile à installer, il se fixe au mur (vis incluses).
- Décapsulage facile d'une seule main.

- Robust und widerstandsfähig.
- Leicht zu montieren, die Befestigung an der Wand erfolgt mit den mitgelieferten Schrauben.
- Leichtes Öffnen mit nur einer Hand.

- Strong and sturdy.
- Easy to install; attaches to the wall (included screws).
- Easy to open with just one hand.

- Robusto e resistente.
- Fácil de montar: fixa-se à parede (parafusos incluídos).
- Abertura fácil, com uma só mão.



### Abrebotellas pared

Décapsuleur mural  
Wandflaschenöffner  
Wall mounted bottle opener  
Abridor de garrafas de parede



Ref	€	cm	U.Venta
63052	4,20	6x3x8	1



# Colección SACACORCHOS



En tres pasos · In three steps



**Autonomía**  
Battery life

30-40

**Botellas**  
Bottles

## Sacacorchos BLACK LUXE

Tire-bouchon  
Korkenzieher  
Corkscrew  
Saca-rolhas

Ref	€	Ø (cm)	h (cm)	U.Venta
63056	38,30	4,8	22	1



- Diseño elegante, moderno y ergonómico: ideal para su uso profesional y de hogar.
- Funcionamiento rápido y sencillo tan solo pulsando un botón.
- Facilita la extracción del corcho de cualquier botella de vino en tan solo 6-8 segundos.
- Extrae el corcho suavemente y de forma silenciosa.
- Cabezal de extracción con iluminación led (63056 / 63057).
- Indicador de batería luminoso mediante LED: 4 niveles para indicar el nivel de energía (63056).
- Se carga mediante cable Micro USB.
- Incluye: cable cargador USB y descapsulador.

- Style élégant, moderne et ergonomique : idéal pour une utilisation aussi bien professionnelle que domestique.
- Fonctionnement rapide et simple en appuyant simplement sur un bouton.
- Facilite l'extraction du bouchon en liège de n'importe quelle bouteille de vin en 6-8 secondes seulement.
- Extraie le bouchon en liège lentement et silencieusement.
- Tête d'extraction avec éclairage led (63056 / 63057).
- Indicateur de batterie lumineux via LED : 4 niveaux pour indiquer le niveau de batterie (63056).
- Se charge à l'aide d'un câble Micro USB.
- Inclut : câble chargeur USB et décapsuleur.

- Elegant, modern and ergonomisch gefertigt – ideal für Haushalt und Gewerbe.
- Funktioniert schnell und einfach per Knopfdruck.
- Passend zum Entkorken der meisten Weinflaschen in nur 6–8 Sekunden.
- Zieht Korken mühelos und geräuschlos.
- Zugvorrichtung mit LED-Beleuchtung (63056 / 63057).
- LED-Batterieanzeige: 4 Energiestandniveaus (63056).
- Mit Micro-USB-Kabel.
- USB-Ladekabel und Kapselschneider inbegriffen.

En tres pasos · In three steps



**Autonomía**  
Battery life

30-40

**Botellas**  
Bottles

## Sacacorchos BLACK

Tire-bouchon  
Korkenzieher  
Corkscrew  
Saca-rolhas

Ref	€	Ø (cm)	h (cm)	U.Venta
63057	29,60	5	19	1



- Smart, modern and ergonomic design - ideal for professional and home use.
- Quick and easy push-button operation.
- Removes the cork from any bottle of wine in just 6-8 seconds.
- Removes the cork gently and quietly.
- Extraction head with led lighting (63056 / 63057).
- Battery indicator led: 4 energy level indicators (63056).
- Charging by Micro USB cable.
- Included: USB charger and decapsulator.

- Design elegante, moderno e ergonómico: ideal para uso profissional e doméstico.
- Funcionamento rápido e fácil com apenas premir um botão.
- Facilita a extração da rolha de qualquer garrafa de vinho em apenas 6-8 segundos.
- Extraí a rolha suavemente e sem ruído.
- Cabeça extratora com iluminação LED (63056 / 63057).
- Indicador luminoso de bateria LED: 4 níveis de energia (63056).
- Carga mediante um cabo Micro USB.
- Inclui: cabo de carga USB e abre-cápsulas.

En tres pasos · In three steps



**Autonomía**  
Battery life

30

**Botellas**  
Bottles

## Sacacorchos eléct. c/base cargador

Tire bouchon électrique a/support charge  
Korkenzieher, elektrisch mit Ladestation  
Electric corkscrew w/charger base  
Saca-rolhas Eléctrico com Base carregador

Ref	€	W	cm	U.Venta
63031	40,70	1,2	Ø12x32	1



**Autonomía**  
Battery life

30-40

**Botellas**  
Bottles

## Sacacorchos c/base cargador BLACK

Tire bouchon électrique avec support charge  
Korkenzieher, elektrisch mit Ladestation  
Electric corkscrew with charger base  
Saca-rolhas eléctrico com base carregador

Ref	€	W	cm	U.Venta
63054	43,70	18	Ø5x25	1



## Sacacorchos negro

Tire-bouchon  
Korkenzieher  
Zinc alloy corkscrew  
Saca-rolhas negro

Ref	€	U.Venta
63028	45,90	1



**Zamak**  
Zinc Alloy

## Sacacorchos doble palanca

Tire-bouchon double levier  
Korkenzieher  
Double-lever corkscrew  
Saca-rolhas dupla alavanca

Ref	€	U.Venta
63013	17,30	1



**Zamak**  
Zinc Alloy

## Sacacorchos profesional

Tire-bouchon automatique professionnel  
Profi-Entkorker  
Professional automatic corkscrew  
Saca-rolhas automático profissional

	Ref	€	U.Venta
<b>A</b>	63010	324,20	1
<b>B</b>	63012	337,40	1



## Multifunción 2 en 1: sacacorchos + abridor de botellas

Multi-purpose: 2 in 1: corkscrew + bottle opener



**Zamak**  
Zinc Alloy

## Sacacorchos CLASSIC

Tire-bouchon  
Korkenzieher  
Zinc alloy corkscrew  
Saca-rolhas negro

Ref	€	U.Venta
63047	10,00	1

## Multifunción 3 en 1: sacacorchos + abridor de botellas + cuchilla corta cápsulas

Multi-purpose: 3 in 1: corkscrew + bottle opener + capsule cutter

**Inox**

## Sacacorchos camarero INOX

Tire-bouchon limonadier  
Kellnerkorkenzieher  
Waiter's corkscrew  
Saca-rolhas con navalha

Ref	€	U.Venta
63018	5,30	6



**Inox**

## Sacacorchos camarero LUXE

Tire-bouchon limonadier  
Kellnerkorkenzieher  
Waiter's corkscrew  
Saca-rolhas con navalha

Ref	€	U.Venta
63044	5,10	1



**Acabado en mate negro**  
Matte black finish

**Inox Madera**  
Wood

## Sacacorchos camarero MADERA

Tire-bouchon limonadier  
Kellnerkorkenzieher  
Waiter's corkscrew  
Saca-rolhas con navalha

Ref	€	U.Venta
63046	7,50	1

**Acabado en mate negro**  
Matte black finish

# Colección BOMBAS DE VACÍO



new



Base cargador eléctrico  
Charging electric base

Incluye 2 tapones con  
indicador de fecha  
Includes 2 caps with  
date indicator

ABS  
Plastic



Carga  
Charge

50

Ciclos de vacío  
Vacuum cycles

- Fabricado en ABS de máxima calidad. Acabado color negro mate.
- Conserva el vino en perfecto estado manteniendo todo su sabor y aroma durante más tiempo.
- Extrae el aire acumulado en el interior de la botella y retrasa el proceso de oxidación.
- Fácil de usar: pulsando un solo botón.
- Ahorra tiempo: cierra la botella con el tapón y presiona el botón para extraer el aire en segundos.
- 100% hermético contra fugas.
- Hasta 60 ciclos de vacío en cada carga.
- Kit completo: incluye 2 tapones con indicador de fecha y cargador eléctrico.

- Fabriquée en ABS de la plus grande qualité et en finition de couleur noire mate.
- Conserve le vin en parfait état en maintenant tout son goût et son arôme plus longtemps.
- Extrait l'air accumulé à l'intérieur de la bouteille et retarde le processus d'oxydation.
- Facile à utiliser : appuyer sur un seul bouton.
- Gain de temps : fermer la bouteille avec le bouchon et appuyer sur le bouton pour extraire l'air en quelques secondes.
- 100% hermétique contre les fuites.
- Jusqu'à 60 cycles de vide à chaque charge.
- Kit complet : inclut 2 bouchons avec indicateur de date et base chargeur électrique.

- Made of high quality ABS plastic in a matte black finish.
- Keeps the wine in perfect condition, retaining all its flavour and aroma for much longer.
- Removes the air trapped inside the bottle and slows down the oxidation process.
- Easy to use: works at the press of a single button.
- Saves time: insert the stopper in the bottle and press the button to remove the air in seconds.
- 100% leak-proof.
- Up to 60 vacuum cycles per charge.
- Complete kit: includes 2 stoppers with date indicator and charging electric base.

## Bomba de vacío LUXE

Pompe à vide  
Weinpumpe  
Vacuum pump  
Bomba de vacío

Ref	€	Ø (cm)	h (cm)	U.Venta
63058	40,30	4,5	20	1

- Conserva el vino en perfecto estado manteniendo todo su sabor y aroma durante más tiempo.
- Extrae el aire acumulado en el interior de la botella y retrasa el proceso de oxidación.
- Cierra la botella con el tapón y bombea de 10 a 20 veces (dependiendo de la cantidad de vino que haya dentro de la botella) para establecer el vacío.
- Incluye bomba de vacío y dos tapones (con indicador de la fecha en la que se ha sellado la botella).

- Conserve le vin en parfait état en maintenant tout son goût et son arôme plus longtemps.
- Extrait l'air accumulé à l'intérieur de la bouteille et retarde le processus d'oxydation.
- Refermez la bouteille avec le bouchon et pompez de 10 à 20 fois (selon la quantité de vin à l'intérieur de la bouteille) pour faire le vide.
- Inclut une pompe à vide et deux bouchons (avec indicateur de la date à laquelle a été scellée la bouteille).

- Wein in einwandfreiem Zustand aufbewahren. Geschmack und Bouquet bleiben länger erhalten.
- Luft wird aus dem Inneren der Weinflasche gezogen. Die Oxidation des Weins verlangsamt sich.
- Flasche mit Stopfen verschließen und 10 bis 20-mal Pumpen (je nach Weinmenge in der Flasche) um Restsauerstoff zu entziehen.
- Inhalt: Weinpumpe und 2 Stopfen (mit Flaschenverschluss mit Datumshinweis).

- Stores wine in perfect condition and keeps all the flavour and aroma for more time.
- Extracts air built up inside the bottle and slows down the oxidation process.
- Close the bottle with the stopper and pump 10 to 20 times (depending on the amount of wine inside the bottle) to establish the vacuum.
- Includes vacuum pump and two stoppers (with indicator of the date on which the bottle has been sealed).

- Conserva o vinho em perfeito estado, preservando todo o seu sabor e aroma durante mais tempo.
- Extrai o ar acumulado no interior da garrafa, e retarda o processo de oxidação do vinho.
- Feche a garrafa com o tampão e acione a bomba 10 a 20 vezes (dependendo da quantidade de vinho existente no interior da garrafa) para criar o vácuo.
- Inclui uma bomba de vácuo e dois tampões (com indicador de a data em que foi selada a garrafa).

Inox  
Silicone

ABS  
plastic  
Tapones  
Stoppers



## Bomba manual vacío

Pompe à vide p/bouteille de vin  
Weinpumpe  
Wine vacuum sealer  
Bomba manual vacío

Ref	€	U.Venta
63033	11,20	1

R63033 3,10 1 Tapones · Stoppers

PP

Polypropilene

## Bomba de vacío KEEP

Pompe à vide  
Weinpumpe  
Vacuum pump  
Bomba de vacío

Ref	€	U.Venta
63051	8,90	1

R63051A 2,30 1 Tapones · Stoppers



# Colección VINOTECA



Inox

## Descapsulador ROND

Coupe capsule  
Foliencutter  
Foil cutter  
Descapsulador



Ref	€	Ø (cm)	U.Venta
63137	4,80	6	12

Inox

## Anilla antigoteo

Anneau stop gouttes à vin  
Weinring Trop-Stop  
Wine drip stop ring  
Anilha anti-gota



Ref	€	Ø (cm)	U.Venta
63019	3,10	5	12

- Diseñado para oxigenar y ralentizar el flujo del vino garantizando un mejor aroma y potenciando los sabores de manera rápida y sencilla.
- Funcionamiento intuitivo: se acopla directamente en la boca de la botella.

- Conçu pour ralentir le flux du vin, garantissant ainsi un meilleur arôme et accentuant les saveurs de façon rapide et simple.
- Fonctionnement intuitif : s'adapte directement sur le goulot de la bouteille.

- Designed to slow down the flow of wine, guaranteeing a better bouquet and enhancing flavours quickly and easily
- Easy to use: attaches directly to the mouth of the bottle.

Si PMMA

Silicone Plastic

## Aireador de vino

Aérateur de vin  
Weinbelüfter  
Wine aerator  
Arejador de vinho



Ref	€	U.Venta
63048	2,80	1

Inox Si

Silicone

## Boquilla servidora + tapón

Bec verseur + bouchon  
Ausgieß-Aufsatz mit Verschluss  
Spout for wine + rubber cap  
Boquilha de servir + tampão



Ref	€	U.Venta
63022	4,40	12

Si 180°C

Silicone max

## Embudo expandible

Entonnoir extensible  
Trichter  
Foldable funnel  
Funil extensível



Ref	€	Ø (cm)	H (cm)	U.Venta
68085	5,90	8	10,5	1

- Conserva durante más tiempo el frescor y el sabor del champán o cava con este exclusivo tapón.
- Fácil de usar.

- Conservez plus longtemps la fraîcheur et le goût du champagne ou du mousseux grâce à ce bouchon exclusif.
- Facile à utiliser.

- Bewahren Sie damit länger die Frische und den Geschmack von Champagner oder Cava exklusiver Stopper.
- Einfach zu verwenden.

- Conserve the freshness and flavour of Champagne or Cava for longer with this exclusive stopper.
- Easy to use.

- Conserve o frescor e o sabor do Champagne ou Cava por mais tempo com este rolha exclusiva.
- Fácil de usar.

PP Inox

Polypropilene

## Tapón champán INOX

Bouchon de champagne  
Sektflaschenverschluss  
Champagne cap  
Tampão champanhê



Ref	€	U.Venta
63021	7,10	1

ABS

Plastic

Bloqueo rotativo  
Rotary lock

## Tapón champán COPPER

Bouchon de champagne  
Sektflaschenverschluss  
Campagne cap  
Tampão champanhê



Ref	€	Ø (cm)	h (cm)	U.Venta
63055	8,00	3,8	3,5	1

# PIZARRAS menú

Madera

Wood



- **Diseño tradicional. Ofrecen un espacio para que los establecimientos de hostelería expongan en sus locales como en la calle sus productos y menús.**
- **Puede ser personalizada tanto con tizas como con rotuladores.**
- **Limpieza muy sencilla, con un simple trapo húmedo.**
- Conception traditionnelle. Offre un espace pour que les établissements d'hôtellerie qui exposent, à l'intérieur ou dans la rue, leurs produits et menus.
- Personnalisable aussi bien avec des craies qu'avec des feutres.
- Nettoyage très facile, avec un simple chiffon humide.
- Traditionelles Design. Bietet eine Fläche, damit die Gastronomiebetriebe in ihren Geschäften ihre Produkte und Menüs darbieten können.
- Kann mit Kreide und Stiften personalisiert werden.
- Sehr einfache Reinigung mit einem feuchten Tuch.
- Traditional design. It offers a space for catering establishments to exhibit their products and menus within their premises as well as out on the street.
- It can be personalized with both chalk and marker pens.
- Very simple cleaning, with just a damp cloth.
- Design tradicional. Proporciona um espaço para que os estabelecimentos de hotelaria possam expor os seus produtos e menus nos locais e na rua.
- Personalizável com giz ou marcadores.
- Fácil de limpar, utilizando um pano húmido.



**Pizarra de aglomerado**  
Chipboard slate

**Madera de pino con acabado caoba**  
Walnut coloured Pinewood

**Sólidos caballetes.**  
**Cadena de seguridad que evita su caída**  
**2 caras para personalizar en tiza o rotuladores fluorescentes (Ref.: 39161). Fácil de limpiar.**

Chevalets solides.  
Chaîne de sécurité pour éviter les chutes  
2 côtés pour personnaliser en craie ou marqueurs fluorescents (Ref.: 39161). Facile à nettoyer.

Solides Holzgestell.  
Sicherheitskette gegen Umkippgefahr.  
2 seitig beschreibbar, mit Kreide oder fluoreszierenden Marker (Ref.: 39161).  
Einfach zu reinigen.

Solid frame.  
Safety chain to prevent it from falling.  
2 sides to customize chalk or fluorescent markers (Ref.: 39161). Easy to clean.

Sólidos cavaletes.  
Corrente de segurança para evitar eventuais quedas.  
2 lados para personalizar em giz ou marcadores fluorescentes (Ref.: 39161). Fácil de limpar.



## Pizarra menú

Menu ardoise  
Schreibtafel Menu  
Menu blackboard  
Quadro de menu

Ref	€	cm	AxB (cm)	U.Venta
39166	92,30	55x85	47x67	1
39164	134,00	65x115	55x90	1



Diseñada para ser colocada en la pared. Personalizable en tiza o rotuladores fluorescentes (Ref.: 39161). Fácil de limpiar.

Conception pour une mise en place sur un mur. Personnalisable en craie ou marqueurs fluorescents (Ref.: 39161). Facile à nettoyer.

Zur Wandaufhängung. Beschreibbar mit Kreide oder fluoreszierenden Markern (Ref.: 39161). Einfach zu reinigen.

Designed to be fixed on the wall. Can be personalised with chalk or fluorescent markers (Ref.: 39161). Easy to clean.

Concebido para ser colocado na parede. Personalizável em giz ou marcadores fluorescentes (Ref.: 39161). Fácil de limpar.

## Pizarra menú

Menu ardoise  
Schreibtafel Menu  
Menu blackboard  
Quadro de menu

	Ref	€	cm	AxB (cm)	U.Venta	
A	39162	50,90	50x80	43x73	1	Cuadrada · Square
B	39163	55,70	50x80	43x73	1	Semi-circulo · Half circle

NO incluidos  
NOT included



- Sistema llamativo**  
Eye-catching system
- Gran impacto visual**  
Great visual impact
- Limpeza muy sencilla**  
Cleaning very simple



## Pizarra eléctrica LED

Tableau lumineux à LED  
Elektronische LED Tafel  
Electric blackboard LED  
Ardósia LED eléctrico

	Ref	€	U.Venta
A	39140	102,70	1
B	39160	141,00	1

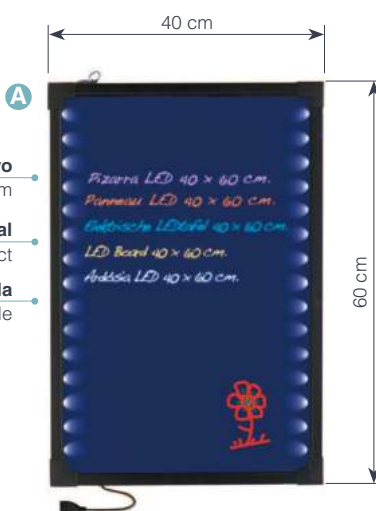

Ref	Tensión/Voltage	Potencia/Power	Funcioned/Functions	Dimensiones/Sizes	Peso/Weight
39140	220-240 V / 50-60 Hz	2 W	38	40x60 cm	2,35 Kg
39160	220-240 V / 50-60 Hz	2 W	38	60x80 cm	4,50 Kg

## Rotuladores fluorescentes 8 colores

Marqueurs fluorescents 8 couleurs  
8-Farben fluoreszierenden marker  
8 Fluorescent markers 8 colors  
Maracadores fluorescentes 8 cores

Ref	€	cm	U.Venta
39161	33,20	10	1



**8 colores para usar con la pizarra eléctrica Led**  
8 colors to use with the Led electric board

**No tóxicos, fácil de limpiar**  
Non toxic, easy to clean

# TAPA · VITRINA expositoras bar



## Protección contra posibles contaminaciones

Protection against food contaminants

- Perfectos para proteger y realzar la exposición de alimentos en mostradores de bares, restaurantes, pastelerías, etc.
- Protección contra posibles contaminaciones de los alimentos.

- Parfaites pour protéger et exposer des produits sur le comptoir des bars, restaurants, pâtisseries, etc.
- Protection contre d'éventuelles contaminations des aliments.

- Ideal zur Präsentation von Produkten auf den Tresen von Bars, Restaurants, Konditoreien usw.
- Schützt Speisen vor Verunreinigungen.

- Perfects for protecting and highlighting products displayed on counters in bars, restaurants, bakeries, etc.
- Protection against potential food contaminants.

- Ideales para proteger e realçar a exposição de produtos nos mostradores de bares, restaurantes, pastelarias, etc.
- Proteção contra qualquer possível contaminação dos alimentos.

### Tapa Roll-Top (Plegable)

Roll-Top Lid (Folding)



### Apertura fácil mediante el pomo

Easy to open with the knob

PC

Polycarbonate

## Tapa expositora GN 1/1

Couvercle de présentation GN 1/1

Rolltop-Haube

GN 1/1 display Case Lid

Expositor com tampa GN 1/1

Ref	€	cm	GN	U.Venta
66907P	36,70	53x32,5	GN 1/1	1

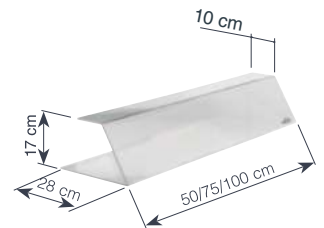

## Vitrina expositora bar

Vitrine de présentation pour bar

Tisch-Vitrine Gaststätte

Bar display Case

Vitrina expositora para bar

Ref	€	cm	e (mm)	U.Venta
39450	56,70	50x28x17	5	1
39445	83,80	75x28x17	5	1
39441	118,90	100x28x17	5	1

# Colección **VITRINAS** expositoras



Desde Lacor lanzamos una nueva línea de vitrinas expositoras. Un total de 5 nuevos modelos de vitrinas neutras, calientes y refrigeradas, diseñadas especialmente para presentar y exponer todo tipo de alimentos, y garantizando siempre la calidad y conservación de estos.

Lacor lance une nouvelle ligne de vitrines d'exposition. Au total, ce sont 5 nouveaux modèles de vitrines neutres, chauffantes et réfrigérées, spécialement conçues pour présenter et exposer tout type d'aliments, toujours avec la garantie de leur qualité et leur conservation.

Lacor bringt eine neue Reihe von Vitrinen heraus. Insgesamt 5 neue Modelle mit oder ohne Kühlung/Heizung, speziell zum Anrichten und Anbieten aller möglichen Speisen mit Qualitäts- und Frischegarantie.

At Lacor we're launching a new line of display cases. There are 5 new models of neutral, warm and refrigerated display cases especially designed to present and display all kinds of food and ensure its quality and conservation at all times.

Lacor lança uma nova linha de vitrinas expositoras. Um de 5 novos modelos de vitrinas neutras, aquecidas e refrigeradas, especialmente concebidas para apresentar e expor todo o tipo de alimentos, garantindo sempre a sua qualidade e correta conservação.

## Vitrina NEUTRA



Parte trasera  
Back side

Puertas traseras abatibles  
Hinged rear doors

- Vitrina neutra construida íntegramente en cristal y base de acero inoxidable.
- Diseñada para presentar y exponer sobre la barra / mostrador.
- Superficie superior curvada para una visión panorámica.
- Estante intermedio de cristal templado.
- Puerta trasera abatible.
- 4 pies de goma que garantizan máxima estabilidad.

- Vitrine neutre intégralement fabriquée en verre et base en acier inoxydable.
- Conçue pour présenter et exposer sur le plan de travail / comptoir.
- Surface supérieure courbée pour une vision panoramique.
- Étagère intermédiaire en verre trempé.
- Porte arrière rabattable.
- 4 pieds en caoutchouc qui garantissent une qualité maximale.

- Einfache Glasvitrine mit Edelstahlsockel.
- Zum Anrichten und Anbieten von Lebensmitteln an der Bar / Theke.
- Gewölbte Glasdecke für optimale Produktpräsentation.
- Mittlere Ablage aus Hartglas.
- Hinten aufklappbar.
- 4 Gummifüße für maximale Standfestigkeit.

- Clear countertop display case made entirely of glass, including a stainless steel base.
- Designed for presenting and displaying food on the bar/countertop.
- Full view curved upper surface.
- Middle shelf made of tempered glass.
- Hinged rear door.
- 4 rubber feet for maximum stability.

- Vitrina neutra fabricada integralmente em vidro, com base de aço inoxidável.
- Para apresentar e expor no balcão / mostrador.
- Superfície superior curva para uma visão panorâmica.
- Prateleira intermédia de vidro temperado.
- Porta traseira rebatível.
- 4 patas de goma para total estabilidade.

### Vitrina neutra

Vitrine neutre  
Einfache vitrine  
Clear countertop display case  
Vitrina neutra

Ref	€	cm	h (cm)	L	U.Venta
69601	285,30	55,4x37,6	37	45	1



# Vitrina TÉRMICA

**69602**

**Combinaciones posibles**  
Possible combinations



**69603**

**Combinaciones posibles**  
Possible combinations

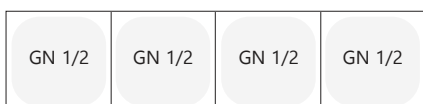
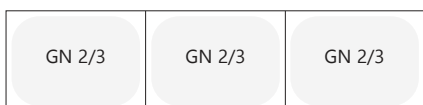

- Vitrina térmica fabricada en acero inoxidable y cristal.
- Diseñada para conservar, presentar y exponer sobre la barra / mostrador.
- Puertas correderas para una accesibilidad total.
- Superficie superior curvada para una visión panorámica.
- 4 / 6 cubetas gastronorm 1/3 incluidas.
- Termostato de control de temperatura regulable: 30 - 90°C.

- Vitrine thermique fabriquée en acier inoxydable et verre.
- Conçue pour conserver, présenter et exposer sur le plan de travail / comptoir.
- Portes coulissantes pour une accessibilité totale.
- Surface supérieure courbée pour une vision panoramique.
- 4 / 6 bacs gastronorm 1/3 inclus.
- Thermostat de contrôle pour régler la température : 30 - 90°C.

- Warmhaltevitrine aus Edelstahl und Glas.
- Zum Aufbewahren, Anrichten und Anbieten von Lebensmitteln an der Bar / Theke.
- Schiebetüren für vollständigen Zugriff.
- Gewölbte Glasdecke für optimale Produktpräsentation.
- 4 / 6 Gastrobehälter 1/3 inbegriffen.
- Einstellbares Thermostat: 30 – 90°C.

- Thermal display case made of stainless steel and glass.
- Designed for storing, presenting and displaying food on the bar/counter top.
- Sliding doors for easy access.
- Full view curved upper surface.
- 4/6 Gastronorm 1/3 trays included.
- Adjustable temperature control thermostat: 30 - 90°C.

- Vitrina térmica fabricada em aço inoxidável e vidro.
- Para conservar, apresentar e expor sobre o balcão / mostrador.
- Portas de correr para total acessibilidade.
- Superfície superior curva para uma visão panorâmica.
- 4 / 6 cubetas Gastronorm 1/3 incluídas.
- Termóstato de controlo de temperatura regulável de 30 a 90° C.



**Puertas traseras correderas**  
Sliding rear doors

**4 / 6 cubetas gastronorm 1/3 incluidas**  
4/6 Gastronorm 1/3 trays included

**Parte trasera**  
Back side



## Vitrina Térmica

Vitrine thermique  
Warmhaltevitrine  
Thermal display case  
Vitrina térmica

	Ref	€	W	Capacidad	U.Venta
A	69602	636,20	500	4xGN1/3	1
B	69603	731,40	800	6xGN1/3	1

Ref	Tensión/Voltage	Potencia/Power	Capacidad/Capacity	Temperatura/Temp.	Protección/Protection	Dimensiones/Sizes	Peso/Weight
69602	220-240 V; 50Hz	500 W	4 x GN 1/3	30°C - 90°C	IPX4	77,3x42x33,6 cm	16 Kg
69603	220-240 V; 50 Hz	800 W	6 x GN 1/3	30°C - 90°C	IPX4	112,7x42x33,6 cm	22 Kg

# Vitrina REFRIGERADA



**Control de temperatura regulable**  
Temperature control thermostat



**Tubo desagüe con tapón**  
Drain tube with cap

- Vitrina refrigerada construida íntegramente en cristal y acero inoxidable.
- Diseñada para conservar, presentar y exponer sobre la barra / mostrador.
- Puertas correderas para una accesibilidad total.
- Superficie superior curvada para una visión panorámica.
- Sistema de enfriamiento por compresor.
- 4 / 6 cubetas gastronorm 1/3 incluidas.
- Termostato de control de temperatura regulable: 0-12°C.
- Sistema de iluminación LED en la cámara interior y display de control de mandos.

- Vitrine réfrigérée intégralement fabriquée en verre et acier inoxydable.
- Conçue pour conserver, présenter et exposer sur le plan de travail / comptoir.
- Portes coulissantes pour une accessibilité totale.
- Surface supérieure courbée pour une vision panoramique.
- Système de refroidissement par compresseur.
- 4 / 6 bacs gastronome 1/3 inclus.
- Thermostat de contrôle pour régler la température : 0-12°C.
- Système d'éclairage LED dans la chambre intérieure et écran de contrôle de commandes.

- Kühlvitrine aus Glas und Edelstahl.
- Zum Aufbewahren, Anrichten und Anbieten von Lebensmitteln an der Bar / Theke.
- Schiebetüren für vollständigen Zugriff.
- Gewölbte Glasdecke für optimale Produktpräsentation.
- Kompressorkühlung.
- 4 / 6 Gastrobekälter 1/3 inbegriffen.
- Einstellbares Thermostat: 0-12°C.
- LED-Innenbeleuchtung und LED-Bedienfeld.

- Refrigerated display case made entirely of glass, including a stainless steel base.
- Designed for storing, presenting and displaying food on the bar/countertop.
- Sliding doors for easy access.
- Full view curved upper surface.
- Compressor cooling system.
- 4/6 Gastronorm 1/3 trays included.
- Adjustable temperature control thermostat: 0-12°C.
- LED lighting for inner chamber illumination and control display unit.

- Vitrina refrigerada fabricada integralmente em vidro e aço inoxidável.
- Para conservar, apresentar e expor sobre o balcão / mostrador.
- Portas de correr para total acessibilidade.
- Superfície superior curva para uma visão panorâmica.
- Sistema de refrigeração por compressor.
- 4 / 6 cusetes Gastronorm 1/3 incluídas.
- Termóstato de controlo de temperatura regulável de 0 a 12° C.
- Iluminação LED interior e display de controlo.

**Puertas traseras correderas**  
Sliding rear doors



## Vitrina refrigerada

Vitrine réfrigérée  
Kühlvitrine  
Refrigerated display case  
Vitrina refrigerada

	Ref	€	W	Capacidad	U.Venta
A	69605	1.236,70	160	4xGN1/3	1
B	69606	1.371,10	160	6xGN1/3	1

Ref	Tensión/Voltage	Potencia/Power	Capacidad/Capacity	Temperatura/Temp.	Refrigerante/Refrig.	Dimensiones/Sizes	Peso/Weight
69605	220-240 V; 50Hz	160 W	4 x GN 1/3	0°C - 12°C	R600a	112,1x45x33 cm	33 Kg
69606	220-240 V; 50 Hz	160 W	6 x GN 1/3	0°C - 12°C	R600a	148,3x45x33 cm	39 Kg

# Vitrina TÉRMICA

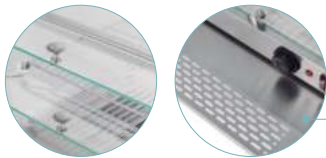

Rejilla extraíble, facilita el flujo del calor  
Removable racks for better heat flow



Parte trasera  
Back side



Puertas traseras abatibles  
Hinged rear doors

## Vitrina térmica

Vitrine thermique  
Warmhaltevitrine  
Thermal display case  
Vitrina tèrmica

Ref	€	W	L	U.Venta
69604	577,00	800	45	1

- Vitrina térmica fabricada en acero inoxidable y cristal.
- Diseñada para conservar, presentar y exponer sobre la barra / mostrador.
- Puerta trasera abatible.
- Superficie superior inclinada para una visión panorámica.
- Recipiente de agua extraíble que aporta humedad en la cámara.
- Termostato de control de temperatura regulable: 30-90°C.
- Bandeja de rejilla extraíble que facilita el flujo del calor.

- Vitrine thermique fabriquée en acier inoxydable et verre.
- Conçue pour conserver, présenter et exposer sur le plan de travail / comptoir.
- Porte arrière rabattable.
- Surface supérieure inclinée pour une vision panoramique.
- Récipient d'eau extractible qui apporte de l'humidité à la chambre.
- Thermostat de contrôle pour régler la température : 30-90°C.
- Plateau grillagé extractible qui facilite le flux de chaleur.

- Warmhaltevitrine aus Edelstahl und Glas.
- Zum Aufbewahren, Anrichten und Anbieten von Lebensmitteln an der Bar / Theke.
- Hinten aufklappbar.
- Geneigte Glasdecke für optimale Produktpräsentation.
- Herausnehmbarer Wasserbehälter sorgt für Luftfeuchtigkeit im Innenbereich.
- Einstellbares Thermostat: 30-90°C.
- Ausziehbarer Ablagerost für gute Wärmezirkulation.

- Thermal display case made of stainless steel and glass.
- Designed for storing, presenting and displaying food on the bar/countertop.
- Hinged rear door.
- Full view curved upper surface.
- Removable water tray to keep the chamber moist.
- Adjustable temperature control thermostat: 30-90°C.
- Removable racks for better heat flow.

- Vitrina térmica fabricada em aço inoxidável e vidro.
- Para conservar, apresentar e expor sobre o balcão / mostrador.
- Porta traseira rebatível.
- Superfície superior inclinada para uma visão panorâmica.
- Recipiente de água extraível, que preserva a humidade na câmara.
- Termóstato de controlo de temperatura regulável de 30 a 90°C.
- Bandeja de rede extraível, que facilita a circulação do calor.

Ref	Tensión/Voltage	Pot./Power	Capacidad/Capacity	Temp./Temp.	Protec./Protection	Parrilla/Grill	Parrilla/Grill (h)	Dimensiones/Sizes	Peso/Weight
69604	220-240 V; 50 Hz	800 W	45	30°C - 90°C	IPX4	52,5x28,5 cm	8,5 cm / 10 cm	55,4x37,6x37,6 cm	14,4 Kg

# Vitrina REFRIGERADA



## Vitrina refrigerada

Vitrine réfrigérée  
Kühlvitrine  
Refrigerated display case  
Vitrina refrigerada

Ref	€	W	L	U.Venta
69607	1.084,00	105	40	1



Parte trasera  
Back side

- Vitrina refrigerada construida íntegramente en cristal y acero inoxidable.
- Diseñada para conservar, presentar y exponer sobre la barra / mostrador.
- Puertas correderas para una accesibilidad total.
- Superficie superior inclinada para una visión panorámica.
- Sistema de enfriamiento por compresor. Función Defrost.
- Termostato de control de temperatura regulable: 2-12°C.
- Sist. de iluminación LED en la cámara interior y display de control de mandos.

- Vitrine réfrigérée intégralement fabriquée en verre et acier inoxydable.
- Conçue pour conserver, présenter et exposer sur le plan de travail / comptoir.
- Portes coulissantes pour une accessibilité totale.
- Surface supérieure courbée pour une vision panoramique.
- Système de refroidissement par compresseur.
- Thermostat de contrôle pour régler la température : 0-12°C.
- Syst. d'éclairage LED dans la chambre intérieure et écran de contrôle de commandes.

- Kühlvitrine aus Glas und Edelstahl.
- Zum Aufbewahren, Anrichten und Anbieten von Lebensmitteln an der Bar / Theke.
- Schiebetüren für vollständigen Zugriff.
- Geneigte Glasdecke für optimale Produktpräsentation.
- Kompressorkühlung. Abtaufunktion (Defrost).
- Einstellbares Thermostat: 2-12°C.
- LED-Innenbeleuchtung und LED-Bedienfeld.

- Refrigerated display case made entirely of glass, including a st. steel base.
- Designed for storing, presenting and displaying food on the bar/countertop.
- Sliding doors for easy access.
- Full view curved upper surface.
- Compressor cooling system. Defrost function.
- Adjustable temperature control thermostat: 2-12°C.
- LED lighting for inner chamber illumination and control display unit.

- Vitrina refrigerada fabricada integralmente em vidro e aço inoxidável.
- Para conservar, apresentar e expor sobre o balcão / mostrador.
- Portas de correr para total acessibilidade.
- Superfície superior inclinada para uma visão panorâmica.
- Sistema de refrigeração por compressor. Função Defrost.
- Termóstato de controlo de temperatura regulável de 2 a 12°C.
- Iluminação LED interior e display de controlo.

Ref	Tensión/Voltage	Potencia/Power	Capacidad/Capacity	Temperatura/Temp.	Refrigerante/Refr.	Dimensiones/Sizes	Peso/Weight
69607	220-240 V; 50Hz	105 W	40	2°C - 12°C	R600a	68x57,5x33,5 cm	25 Kg



# Portamenú

Portamenu

# PORTAMENÚ acrílico · aluminio

ASA AL

Acrylic Aluminium



- Diseño elegante, moderno y fabricado con materiales de máxima calidad.
- Soporte de aluminio.
- 2 o 3 posibilidades de montaje; atril, pared y sobremesa.
- Apto para mostrar menús de tamaño A4 / A3.
- Hoja de información intercambiable de forma fácil, rápida y cómoda.
- Uso en interiores y exteriores.

- Style élégant, moderne et fabriqué avec des matériaux de première qualité.
- Support en aluminium.
- 2 ou 3 possibilités de montage : debout, au mur et sur la table.
- Apte pour afficher des menus de format A4 / A3.
- Changement des documents de façon rapide, facile et pratique.
- Usage à l'intérieur et à l'extérieur.

- Hochwertige Materialien, elegant und modern geformt.
- Aluminiumständer.
- 2 oder 3, Freistehend oder für Wand- oder Tischmontage.
- Für Speisekarten im A4 / A3-Format.
- Informationsblatt schnell, einfach und bequem austauschbar.
- Für den Außen- und Innenbereich.

- An elegant, modern design and manufactured with top quality materials.
- Aluminium stand.
- 2 or 3 mounting possibilities; standing, wall and desktop.
- Suitable for displaying A4 / A3 size menus.
- An easy, quick and convenient exchangeable Information sheet.
- Indoor and outdoor use.

- Design elegante e moderno, fabricado com materiais de primeira qualidade.
- Suporte de alumínio.
- 2 ou 3 possibilidades de montagem; de pé, de parede e em cima de uma mesa.
- Apto para mostrar menus de tamanho A4 / A3.
- Hoja de informação intercambiável, de maneira fácil, rápida e cómoda.
- Uso em interiores e exteriores.

## ACRÍLICO

3 opciones de montaje · Mounting possibilities



**Atril: gracias al soporte de aluminio**  
Lutrin: grâce au support en aluminium  
Notenpult: Dank der Aluminiumstütze  
Lectern: thanks to the aluminum support  
Atril: graças ao suporte de alumínio



**Pared: gracias a los accesorios incluidos para anclar en la pared**  
Mur: grâce aux accessoires inclus à ancrer au mur  
Wand: Dank des mitgelieferten Zubehörs zur Verankerung an der Wand  
Wall: thanks to the included accessories to anchor on the wall  
Parede: graças aos acessórios incluídos para fixar na parede



**Sobremesa: gracias a los pies de apoyo incluidos**  
Bureau: grâce aux pieds de support inclus  
Schreibtisch: Dank der mitgelieferten Stützfüße  
Table: thanks to the support feet included  
Mesa: graças aos pés de apoio incluídos



**Intercambiable de forma fácil, rápida y cómoda**  
Interchangeable facilement, rapidement et confortablement  
Einfach, schnell und bequem austauschbar  
An easy, quick and convenient exchangeable  
Intercambiável com facilidade, rapidez e conforto

## ALUMINIO

2 opciones de montaje · Mounting possibilities



**Atril: gracias al soporte de aluminio**  
Lutrin: grâce au support en aluminium  
Notenpult: Dank der Aluminiumstütze  
Lectern: thanks to the aluminum support  
Atril: graças ao suporte de alumínio



**Pared: gracias a los accesorios incluidos para anclar en la pared**  
Mur: grâce aux accessoires inclus à ancrer au mur  
Wand: Dank des mitgelieferten Zubehörs zur Verankerung an der Wand  
Wall: thanks to the included accessories to anchor on the wall  
Parede: graças aos acessórios incluídos para fixar na parede



**Lámina de polipropileno para evitar el degradado de la hoja de información. Marco de apertura con un solo click**  
Lame de polypropylène pour empêcher la dégrader dans feuille d'information. Cadre d'ouverture en un clic  
Polypropylen-Folie, um zu verhindern, dass sich das Informationsblatt verschlechtert. Ein-Klick-Öffnungsrahmen  
Polypropylene sheet to prevent the degradation in information sheet. One-click opening frame  
Folha de polipropileno para impedir a degradação da folha de informações. Moldura de abertura com um clique



**Intercambiable de forma fácil, rápida y cómoda**  
Interchangeable facilement, rapidement et confortablement  
Einfach, schnell und bequem austauschbar  
An easy, quick and convenient exchangeable  
Intercambiável com facilidade, rapidez e conforto

# Acrílico

## ASA

Acrylic

### Portamenú

Porte-menu  
Menü-Ständer  
Menu holder  
Porta-menus

	Ref	€	cm	U.Venta
A	39403	72,40	50x38 (A3)	1
B	39404	55,70	29x38 (A4)	1

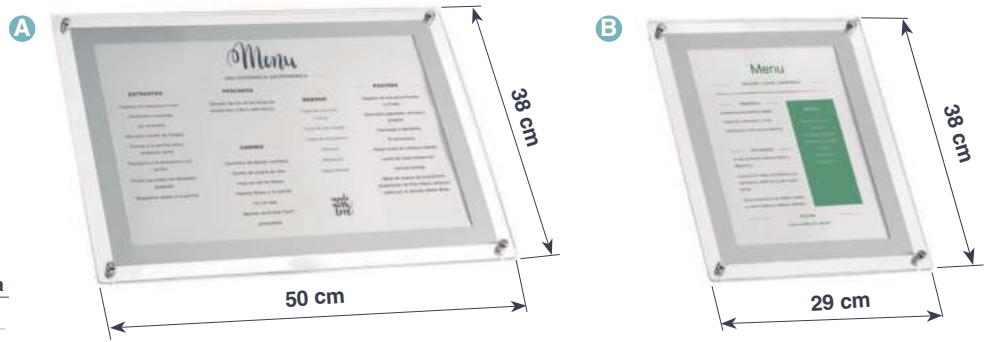

## ASA AL

Acrylic Aluminium

### Atril portamenú

Pupitre porte-menu  
Menü-Ständer  
Menu holder lectern  
Atril porta-menus

	Ref	€	cm	Tamaño	U.Venta	
A	39402	144,90	34x30x1,03 m	-	1	Soporte · Support
B	39423	217,30	34x30x1,07 m	A3	1	Atril A3 · A3 lectern
C	39424	200,50	34x30x1,07 m	A4	1	Atril A4 · A4 lectern



# Aluminio

## AL

Aluminium

### Portamenú

Porte-menu  
Menü-Ständer  
Menu holder  
Porta-menus

	Ref	€	cm	U.Venta
A	39413	39,10	46x34 (A3)	1
B	39414	27,90	25,5x34 (A4)	1



## AL

Aluminium

### Atril portamenú

Pupitre porte-menu  
Menü-Ständer  
Menu holder lectern  
Atril porta-menus

	Ref	€	cm	Tamaño	U.Venta	
A	39402	144,90	34x30x1,03 m	-	1	Soporte · Support
B	39433	183,90	34x30x1,07 m	A3	1	Atril A3 · A3 lectern
C	39434	172,70	34x30x1,07 m	A4	1	Atril A4 · A4 lectern



# PORTAMENÚ sobremesa



**Fijación mediante imán**  
Magnetic fixing

**Visualización a doble cara**  
Double-sided display



**Base desmontable**  
Removable base

**ASA**

Acrylic



## Portamenú sobremesa

Porte-menu de table  
Desktop-Menu  
Menu cover  
Porta menu de mesa

Ref	€	cm	U.Venta
39405	10,30	11x17	1
39406	11,30	13x19	1
39407	24,40	21x30	1

- Ideales para resaltar todo tipo de información (menú, especialidades del día, promociones, etc.).
- Desmontables para escribir fácilmente.
- Fácil limpieza.

- Idéales pour faire ressortir tout type d'information (Menu, spécialités du jour, promotions, etc.).
- Démontables pour écrire confortablement.
- Nettoyage facile.

- Ideal zur Visualisierung aller möglichen Informationen (Menü, Tagesgerichte, Angebote usw.).
- Demontierbare, um bequem zu schreiben.
- Einfache Reinigung.

- Perfect for displaying all kinds of information (Fixed price menu, daily specials, promotions, etc.).
- Can be taken apart for easier writing.
- Easy to clean.

- Ideal para destacar todo o tipo de informação (Menu, especialidades do dia, promoções, etc.).
- Desmontável, para escrever comodamente.
- Fácil de limpar.

**Apta para rotuladores fluorescentes (Ref.: 39161)**  
Can be used with fluorescent markers (Ref.: 39161)



**Soporte de madera de pino con acabado caoba**

Walnut coloured Pinewood support

## Pizarra sobremesa

Ardoise de table  
Tischmenü-Tafel  
Tabletop Chalkboard  
Quadro para mesa

Ref	€	cm	U.Venta
39415	15,10	10x15	1
39420	17,90	15x20	1
39430	22,10	20x30	1

**Soporte de madera de pino con acabado caoba**  
Walnut coloured Pinewood support



## Menú sobremesa

Menu de table  
Tischmenü-Tafel  
Menu Chalkboard  
Menu para mesa

Ref	€	cm	U.Venta
39410	22,70	18x23	1
<b>A</b> 39411	7,00	-	1

**Pinza** · Clamp

# PORTAMENÚ mesa



## Materiales certificados

Matériaux certifiés · Zertifizierte Materialien · Authorised materials · Materiais certificados

### • Similpiel •



**Poliuretano de gran calidad con una base de tejido sin tejer suave y ligeramente extensible. Aspecto de piel y tacto único. Gracias al material termovirante, permite conseguir un atractivo efecto de estampado, consiguiendo diferentes colores según la temperatura que se le aplique.**

Polyuréthane de grande qualité avec une base de tissu intissé doux et légèrement extensible. Aspect cuir et toucher unique. Grâce au matériau thermo virant, l'on obtient un effet d'imprimé attractif, ainsi que différentes couleurs selon la température qui lui sera appliqué.

Polyurethan in hoher Qualität mit einer Basis aus weichem und leicht dehnbarem Vliesstoff. Sieht wie Leder aus und fühlt sich einzigartig an. Durch das temperatursensible Material wird ein Druckeffekt mit verschiedenen Farbtönen je nach Temperatur erzeugt.

High quality polyurethane with a base of soft and slightly extendible unwoven fabric. Leather appearance and unique feel. Thanks to its heat burnishing material an attractive, printed effect is achieved, enabling different colours according to the temperature applied to it.

Poliuretano de grande qualidade, com uma base de tela não tecida suave e ligeiramente extensível. Aspeto de pele e tato único. O material sensível à temperatura permite conseguir um atrativo efeito de estampado, com diferentes cores segundo a temperatura aplicada.

### • Telflex •

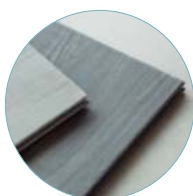

**Material compuesto por un soporte celulósico recubierto con una capa vinílica de alta resistencia. Se caracteriza por su gran flexibilidad, durabilidad y resistencia a la abrasión, manchado y rayado. Acabado imitación tela.**

Matériau composé d'un support cellulosique recouvert d'une couche vinylique hautement résistante Il se caractérise par sa grande flexibilité, durabilité et résistance à l'abrasion, aux taches et aux rayures. Finition imitation tissu.

Material auf Zellulosebasis mit einer widerstandsfähigen Vinylbeschichtung. Es zeichnet sich durch seine hohe Flexibilität, Haltbarkeit und Widerstandsfähigkeit gegen Reibung, Flecken und Kratzer aus. Oberfläche aus Stoff-Imitat

A material comprised of a cellulose-based support covered with a high resistance vinyl layer. Characterised by its great flexibility, durability and resistance to abrasion, stains and scratches. Imitation fabric finish.

Material composto por um suporte celulósico revestido com uma camada vinílica de alta resistência. Carateriza-se pela sua grande flexibilidade, durabilidade e resistência à abrasão, às manchas e aos riscos. Acabamento a imitar tela.

### • Fibra virgen natural •



**Fabricadas en fibra virgen natural. Material ecológico y respetuoso con el medio ambiente. Lavables, resistentes y duraderas. Tacto agradable y suave, similar a la piel. Espesor 0,55 mm.**

Fabriquées en fibres vierges naturelles. Matériau écologique et respectueux de l'environnement. Lavables, résistantes et durables. Toucher agréable et doux, similaire au cuir. Épaisseur de 0,55 mm.

Aus naturreiner Faser. Umweltverträgliches Öko-Material. Waschbar, robust und langlebig. Weich und angenehm wie Leder. 0,55 mm dick

Made of natural virgin fibre. Ecological material respectful with the environment. Washable, resistant and durable. Nice soft feel, similar to leather. Thickness 0.55 mm.

Fabricados em fibra virgem natural. Material ecológico, respeitador do meio ambiente. Laváveis, resistentes e duráveis. Tato agradável e suave, similar ao do couro. Espessura 0,55 mm.

### • PVC •

#### PVC

Plastic

**Fabricados en PVC rígido transparente de alta calidad. Versátiles, económicos, resistentes y ligeros. Hojas transparentes por ambos lados. Ribeteado con cuero cosido en recto. Esquineros metálicos de color negro. Se limpian fácilmente con solución hidroalcohólica sin dañar el producto.**

Fabriqué en PVC rigide transparent de grande qualité. Versatiles, économiques, résistants et légers. Feuilles transparentes des deux côtés. Finition avec du cuir cousu sur le recto. Angles métalliques de couleur noire. Nettoyage facile avec du savon, de l'alcool, du gel hydroalcoolique, etc. sans abîmer le produit.

Aus transparentem und hochwertigem Hart-PVC. Vielseitig einsetzbar, preiswert, Strapazierfähig und leicht. Beidseitig transparent. Gradlinig genähter Ledersaum. Schwarze Metallecken. Zur einfachen Reinigung mit Seife, Alkohol, Gelmittel usw. geeignet.

Made of high quality transparent rigid PVC. Versatile, economical, strong and light weight. Transparent sheets on both sides. Edged with straight sewn leather. Black metal corner pieces. Easy to clean with soap, alcohol, hydrogel, etc. without damaging the product.

Fabricados em PVC rígido transparente, de alta qualidade. Versáteis, económicos, resistentes e ligeiros. Folhas transparentes de ambos os lados. Debruado a couro cosido reto. Esquinas metálicas em preto. Limpam-se facilmente com sabão, álcool, hidrogel, etc., sem danificar o produto.

#### NOTA · NOTE:

**La limpieza deberá realizarse con un paño húmedo, pero no saturado de agua. Evite el contacto y la inmersión en agua. Evite manipularlo con las manos mojadas. NO aptos para el lavavajillas**

The cleaning should be done with a damp cloth, but not saturated with water. Avoid contact and immersion in water. Avoid handling with wet hands. NOT suitable for dishwashers

Antibacteriano ·  
Antibacterial





# Personalización

Personnalisation · Individuelle Anpassung · Customization · Personalização



Lacor pone a disposición del cliente la opción de personalizar cualquiera de las colecciones. La personalización se realiza mediante la técnica de estampado en caliente ( termosellado). El logotipo deberá ser enviado vectorizado en formato Adobe Illustrator sino el vectorizado del sello se cobrará 20 €.

Se debe indicar tanto el posicionamiento como el color entre las siguientes opciones:

Lacor propose au client la possibilité de personnaliser n'importe laquelle des collections. La personnalisation est réalisée selon la technique d'estampage à chaud (Thermoscellage). Pour ce faire, le logo devra être envoyé vectorisé en format Adobe Illustrator mais la vectorisation du timbre sera facturée 20 €. Il est nécessaire d'indiquer aussi bien le positionnement que la couleur parmi les options suivantes :

Lacor ermöglicht dem Kunden die individuelle Anpassung jeder der Kollektionen. Die individuelle Anpassung erfolgt mittels Heißprägung. Das Logo muss vektorisiert im Adobe Illustrator-Format bereitgestellt werden, andernfalls wird das Vektorisieren des Logo mit € 20 berechnet. Aus den folgenden Optionen muss die Position und die Farbe ausgewählt werden:

Lacor offers clients the option of customising any of its collections. Customisation is performed via hot stamping. The logo must be sent in vector format using Adobe Illustrator but the vectorization of the stamp will be charged 20€. Both the position and the colour of the logo must be indicated, choosing from the following options:

Lacor oferece ao cliente a opção de personalizar qualquer das coleções. A personalização é feita utilizando a técnica de estampado a quente (termoselagem), devendo o utilizador enviar o logótipo vectorizado, em formato Adobe Illustrator mas a vectorização do carimbo será cobrado 20€. Indicar tanto o posicionamento como a cor, entre as seguintes opções:

## Precio · Tarif · Preisliste · Cost · Custo:

España & Portugal: 42€ / Francia: 46€ ( a partir de 15 unidades)  
Espagne & Portugal: 42€ / France: 46€ (à partir de 15 unités)  
Spanje & Portugal: 42€ / Frankrijk: 46€ ( ab 15 Einheiten)  
Spain & Portugal: 42€ / France: 46€ ( minimum 15 units)  
Espanha & Portugal: 42€ / França: 46€ ( a partir de 15 unidades)

## \* Nota · Note:

El plazo de entrega para los portamenús personalizados es de 15 días naturales  
The delivery period for the personal portamenús is 15 calendar days

	<b>Posicionamiento orientativo</b> Guidance position	<b>Color</b> Couleur · Farbe · Colour · Cor
	<b>A: Óptico</b> · Optical	<input type="radio"/> <b>En seco (sin color)</b> · Dry (without colour)
	<b>B: Centro</b> · Centre	<input type="radio"/> <b>Blanco</b> · White
	<b>C: Pie centro</b> · Bottom centre	<input checked="" type="radio"/> <b>Negro</b> · Black
<b>D: Pie drecho</b> · Bottom right	<input type="radio"/> <b>Rojo</b> · Red	
		<input type="radio"/> <b>Oro</b> · Gold
		<input type="radio"/> <b>Plata</b> · Silver
		<input type="radio"/> <b>Crema</b> · Cream
		<input type="radio"/> <b>Marrón</b> · Brown
		<input type="radio"/> <b>Azul</b> · Blue

## NOTA · NOTE:

**NO se recomienda la estampación en seco en las colecciones**  
Dry printing is NOT recommended in the collections

LISA · VELÁZQUEZ · HELEN · TOMASSO · ANDRÉ · MATISSE · CHARLOTTE · DEGAS · CASSAT · EDGAR  
SOPHIE · PAUL · GOYA · MARCEL · ANDY · NATURAL · TEX

· **Made in Spain** ·

**Fabricados en España · Fabriqués en Espagne**  
**Spanischer produktion · Fabricados en Espanha**

# Fijaciones

Fixation · Befestigung · Fixings · Fixação

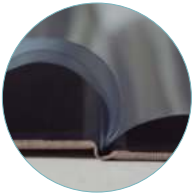

## FUNDAS fijas PVC

Protège-feuilles PVC · PVC hüllen · PVC covers · Capa de PVC

### Fundas fijas de PVC en piel de naranja. Altamente resistentes

Protège-feuilles fixes en PVC en peau d'orange. Hautement résistantes  
Hüllen aus PVC in Orangenhaut Sehr widerstandsfähig  
Highly resistant, fixed frosted PVC covers  
Capas fixas de PVC a imitar pele de laranja. Altamente resistentes



## SOLAPAS fijas

Rabats fixes · Feste klappen · Fixed flaps · Abas fixas

### Solapas fijas a la cubierta

Rabats fixes sur la couverture  
Am Einband befestigte Klappen  
Flaps fixed to the cover  
Abas fixas à cobertura

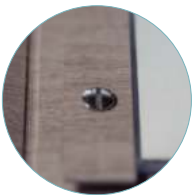

## ATORNILLADO interior

Vissage intérieur · Innere verschraubung · Screwed interior · Aparafusamento interior

### Atornillado interior permite añadir o cambiar hojas o fundas según necesidad del cliente

Vissage intérieur pour intégrer des feuilles ou des protège-feuilles selon les besoins de l'utilisateur  
Innere Verschraubung zur Anbringung von Blättern oder Hüllen, je nach Bedarf des Benutzers  
Screwed interior to include pages or covers, according to the user's needs  
Aparafusamento interior para incluir lâminas ou capas, segundo as necessidades do utilizador



## ATORNILLADO exterior

Vissage extérieur · Äußere verschraubung · Screwed exterior · Aparafusamento exterior

### Atornillado exterior permite añadir hojas o fundas según necesidad del cliente

Vissage extérieur pour intégrer des feuilles ou des protège-feuilles selon les besoins de l'utilisateur  
Äußere Verschraubung zur Anbringung von Blättern oder Hüllen, je nach Bedarf des Benutzers  
Screwed exterior to include pages or covers, according to the user's needs  
Aparafusamento exterior para incluir lâminas ou capas, segundo as necessidades do utilizador



## CORDÓN DE CUERO

Cordon en cuir · Lederband · Leather cord · Cordão de couro

### Encuadernado con cordón de cuero. Permite añadir hojas o fundas según necesidad del cliente

Relié avec un cordon en cuir. Permet d'ajouter des feuilles ou des pochettes selon les besoins du client  
Ermöglicht das Hinzufügen von Blättern oder Deckblättern je nach Kundenwunsch  
Bound with leather cord. New pages or covers can be added as the customer needs  
Encadernado com cordão de couro. Permite acrescentar folhas ou capas, segundo as necessidades do cliente



## GOMA

Élastique · Gummi · Elastic band · Elástico

### Encuadernado con goma. Permite añadir hojas o fundas según necesidad del cliente

Relié avec élastique. Permet d'ajouter des feuilles ou des pochettes selon les besoins du client  
Ermöglicht das Hinzufügen von Blättern oder Deckblättern je nach Kundenwunsch  
Bound with elastic band. New pages or covers can be added as the customer needs  
Encadernado com elástico. Permite acrescentar folhas ou capas, segundo as necessidades do cliente



## PINZA

Pince · Klammer · Clip · Pinça

### Con pinza metálica de color plata que sujeta la hoja del menú

Doté d'une pince métallique couleur argent qui tient la feuille du menu  
Mit silberner Klammer aus Metall als Menühalter  
With a silver-coloured metal clip that holds the menu in place  
Com pinça metálica prateada para sujeitar a folha do menu

## Accesorios

Accessoires · Zubehör · Accessories · Acessórios

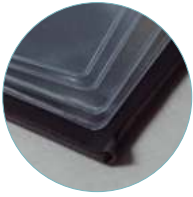

### Set 10 fundas interiores PVC piel de naranja

Jeu 10 feuilles intérieures PVC Peau d'orange  
10 Tlg. Innere Blätter, PVC, Orangerhaut  
Set 10 interior frosted PVC pages  
Set 10 lâminas interiores de PVC pele de Laranja

Ref	€	cm	U.Venta	
28191	11,70	21x29,7 (A4)	10	Ref.: 28261, 28500, 28510, 28520, 28530
28192	9,10	14x26	10	Ref.: 28511, 28531, 28521, 28501, 28212, 28262
28190	8,10	16x29,7	10	Ref.: 28342, 28352, 28372
28193	9,20	14,8x21 (A5)	10	Ref.: 28512, 28343, 28532, 28353, 28522, 28373, 28502, 28213, 28263
28194	11,70	21x29,7 (A4)	10	Ref.: 28550, 28540, 28371, 28351
28203	11,70	25x32 (A4)	10	Ref.: 28211, 28231, 28341, 28341, 28391
28451	11,90	23x31 (Doble/Double)	10	Ref.: 28411, 28431
28452	10,30	17x32 (Doble/Double)	10	Ref.: 28412, 28432
28453	7,30	16,5x23,5 (Doble/Double)	10	Ref.: 28413, 28423, 28443



### Set 12 cantoneras

Jeu 12 coins  
12 Tlg. Kantenschutz  
Set 12 angle irons  
Set 12 cantoneiras

Ref	€	Color	U.Venta
28195	5,10	Negro · Black	1
28197	5,10	Oro · Gold	1
28198	5,10	Plata · Silver	1



### Set 12 tornillos

Jeu 12 vis  
12 Tlg. Schrauben  
Set 12 screws  
Set 12 parafusos

Ref	€	Color	U.Venta
28196	10,60	Plata · Silver	1
28199	10,90	Negro · Black	1



### Set 12 cordones de cuero

Jeu 12 cordons en cuir  
12 Tlg. Lederschnur  
Set 12 leather laces  
Set 12 cordões de couro

Ref	€	Color	m	U.Venta
28200	1,50	Marrón · Brown	1	12

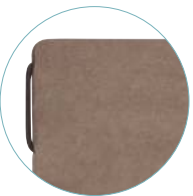

### Set 10 gomas

Jeu 10 élastiques  
10 Tlg. Gummis  
Set 10 elastic bands  
Set 10 elásticos

Ref	€	Color	U.Venta	
28205	7,20	Negro · Black	1	Ref.: 28411, 28412, 28422, 28432
28206	7,20	Negro · Black	1	Ref.: 28413, 28433

# PORTAMENÚ PVC

## Antibacteriano · Antibacterial

- Ideal para cartas de restaurantes, bares, hoteles, etc.
- Fabricados en PVC rígido transparente de alta calidad.
- Versátiles y económicos. Resistentes y ligeros.
- Hojas transparentes por ambos lados.
- Ribeteado con cuero cosido en recto.
- Esquineros metálicos de color negro.
- Se limpian fácilmente con solución hidroalcohólica sin dañar el producto.

- Idéal pour les cartes des restaurants, bars, hôtels, etc.
- Fabriqués en PVC rigide transparent de grande qualité.
- Versatiles et économiques. Résistants et légers.
- Feuilles transparentes des deux côtés.
- Finition avec du cuir cousu sur le recto.
- Angles métalliques de couleur noire.
- Nettoyage facile avec du savon, de l'alcool, du gel hydroalcoolique, etc. sans abîmer le produit.

- Perfect for restaurant, bar or hotel menus.
- Made of high quality transparent rigid PVC.
- Versatile and economical. Strong and light weight.
- Transparent sheets on both sides.
- Edged with straight sewn leather.
- Black metal corner pieces.
- Easy to clean with soap, alcohol, hydrogel, etc. without damaging the product.



Opción de personalizar \*  
Option of customising \*

\* Se recomienda hacerlo en los colores **blanco, azul, negro, rojo y marrón**.  
Il est recommandé de le faire dans les couleurs **blanc, bleu, noir, rouge et marron**.  
Es wird empfohlen, dies in den Farben **Weiß, Blau, Schwarz, Rot und Braun** zu tun.  
It is recommended to do it in the colors **white, blue, black, red and brown**.  
Recomenda-se fazê-lo nas cores **branco, azul, preto, vermelho e marrom**.



Esquineros metálicos  
Metal corners

### Portamenú A5

Porte-menu A5  
Speisekartenmappe, A5  
A5 menu cover  
Porta menu A5

	Ref	€	cm	Fundas	U.Venta
A	28400	8,10	A5	Individual · Individual	1
B	28401	12,40	A5	Doble · Double	1



Esquineros metálicos  
Metal corners

### Portamenú A4

Porte-menu A4  
Speisekartenmappe, A4  
A4 menu cover  
Porta menu A4

	Ref	€	cm	Fundas	U.Venta
A	28402	9,90	A4	Individual · Individual	1
B	28403	16,50	A4	Doble · Double	1
C	28404	19,20	A4	Triple · Triplex	1
D	28405	20,80	A4	Cuádruple · Quadruple	1

# NATURAL

## Termosellado en color negro

Thermoscellage en couleur noir  
Die Heißprägung ist in den Farben schwarz  
Heat stamping in black  
Termoselagem disponível nas cores negro

## Portamenú

Porte-menu  
Speisekartenmappe  
Menu cover  
Porta menu

	Ref	€	cm	Fundras	U.Venta
A	28411	20,80	23x32 (A4)	4	4
B	28412	19,20	17x32	6	4
C	28413	17,00	16,5x23,5 (A5)	6	4

**Sujeción con goma**  
Closes with elastic band

**Fabricado en fibra virgen natural**  
Fabriquée en fibre vierges naturelle  
Aus naturreiner Faser  
Made of natural virgin fibre  
Fabricado em fibra virgem natural



Blando · Soft

# TEX

## Termosellado en color negro

Thermoscellage en couleur noir  
Die Heißprägung ist in den Farben schwarz  
Heat stamping in black  
Termoselagem disponível nas cores negro

## Portamenú

Porte-menu  
Speisekartenmappe  
Menu cover  
Porta menu

	Ref	€	cm	Fundras	U.Venta
A	28431	20,80	23x32 (A4)	4	4
B	28432	19,20	17x32	6	4
C	28433	17,00	16,5x23,5 (A5)	6	4

**Sujeción con goma**  
Closes with elastic band

**Fabricado en fibra virgen natural**  
Fabriquée en fibre vierges naturelle  
Aus naturreiner Faser  
Made of natural virgin fibre  
Fabricado em fibra virgem natural



Blando · Soft

# HELEN

## Termosellado en color marrón

Thermoscellage en couleur marron  
Die Heißprägung ist in den Farben braun  
Heat stamping in brown  
Termoselagem disponível nas cores castanho

## Portamenú

Porte-menu  
Speisekartenmappe  
Menu cover  
Porta menu

	Ref	€	cm	Fundras	U.Venta
A	28341	25,50	25,5x32 (A4)	3	4
B	28342	20,90	19,5 x 32	3	4
C	28343	19,70	19x23,5 (A5)	3	4

**Fabricado en simlpiel**  
Fabriqué en cuir simili - cuir  
Hergestellt aus Lederimitat  
Manufactured in imitation leather  
Fabricado em simil - pele

**Encuadrado con cordón de cuero**  
Bound with leather cord

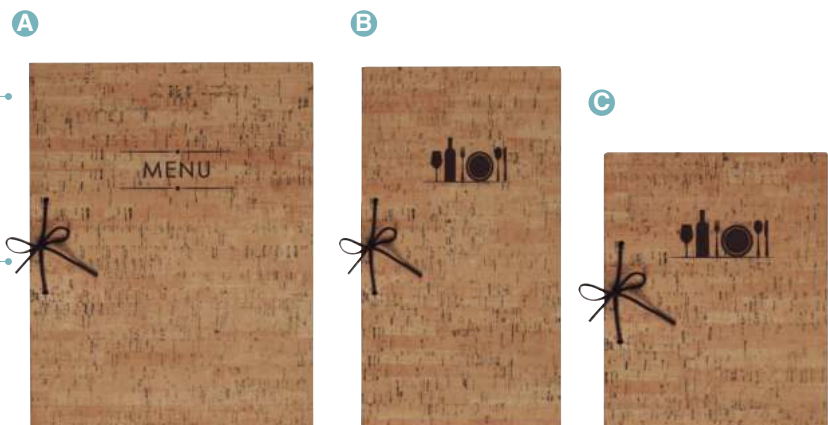

# VELÁZQUEZ



## Termosellado en color marrón

Thermoscellage en couleur marron  
Die Heißprägung ist in den Farben braun  
Heat stamping in brown  
Termoselagem disponível nas cores castanho

## Portamenú

Porte-menu  
Speisekartenmappe  
Menu cover  
Porta menu

**Sujeción fija**  
Fixed clamping

**Fabricado en simlpiel**  
Fabriqué en cuir simili - cuir  
Hergestellt aus Lederimitat  
Manufactured in imitation leather  
Fabricado em simil - pele

	Ref	€	cm	Fundas	U.Venta
<b>A</b>	28331	24,40	23x32 (A4)	4	4
<b>B</b>	28332	19,50	16x28,5	4	4
<b>C</b>	28333	18,60	17x23,5 (A5)	4	4

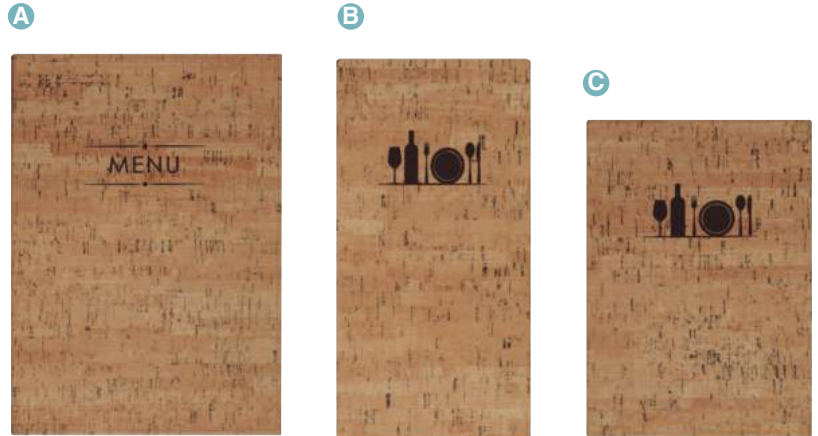

Porta menú  
Menu cover

## Portacomandas

Porte-commandes  
Halter für Bestellungen  
Order holder  
Porta comandas



Ref	€	cm	U.Venta
28175	12,00	11x17,5	4

## Portafacturas

Porte-factures  
Halter für Rechnungen  
Ticket holder  
Porta faturas



Ref	€	cm	U.Venta
28176	19,20	11x18,5	4

# LISA



## Termosellado en color marrón

Thermoscellage en couleur marron  
Die Heißprägung ist in den Farben braun  
Heat stamping in brown  
Termoselagem disponível nas cores castanho

**Solapas fijas a la cubierta**  
Flaps fixed to the cover

**Fabricado en simlpiel**  
Fabriqué en cuir simili - cuir  
Hergestellt aus Lederimitat  
Manufactured in imitation leather  
Fabricado em simil - pele

## Portamenú

Porte-menu  
Speisekartenmappe  
Menu cover  
Porta menu

Ref	€	cm	U.Venta
28177	22,30	23 x 32 (A4)	4



# SANDRO



## Termosellado en color azul

Thermoscellage en couleur bleu  
Die Heißprägung ist in den Farben blau  
Heat stamping in blue  
Termoselagem disponível nas cores azul

## Atornillado exterior permite añadir hojas o fundas según necesidad del cliente

Screwed exterior to include pages or covers, according to the user's needs

## Portamenú

Porte-menu  
Speisekartenmappe  
Menu cover  
Porta menu

### Fabricado en telflex

Fabriqué en cuir telflex  
Hergestellt aus Telflex  
Manufactured in telflex  
Fabricado em telflex

	Ref	€	cm	Fundas	U.Venta
A	28371	24,70	25,5x32 (A4)	3	4
B	28372	20,30	19,5x32	3	4
C	28373	18,90	19x23,5 (A5)	3	4

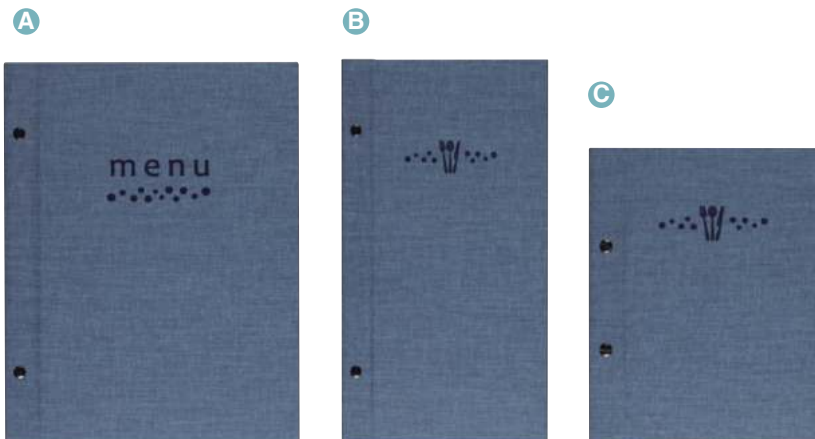

## Portacomandas

Porte-commandes  
Halter für Bestellungen  
Order holder  
Porta comandas



Ref	€	cm	U.Venta
28375	11,60	11x17,5	4

## Portafacturas

Porte-factures  
Halter für Rechnungen  
Ticket holder  
Porta faturas



Ref	€	cm	U.Venta
28376	18,50	11x18,5	4

# RENÉ



## Termosellado en color crema

Thermoscellage en couleur crème  
Die Heißprägung ist in den Farben cremefarben  
Heat stamping in cream  
Termoselagem disponível nas cores creme

### Sujeción fija

Fixed clamping

### Fabricado en simlpiel

Fabriqué en cuir simili - cuir  
Hergestellt aus Lederimitat  
Manufactured in imitation leather  
Fabricado em simil - pele

## Portamenú

Porte-menu  
Speisekartenmappe  
Menu cover  
Porta menu

	Ref	€	cm	Fundas	U.Venta
A	28021	24,40	23x32 (A4)	4	4
B	28022	18,60	16x28,5	4	4
C	28023	19,50	17x23,5 (A5)	4	4



# NICOLÁS



## Termosellado en color crema

Thermoscellage en couleur crème  
Die Heißprägung ist in den Farben cremefarben  
Heat stamping in cream  
Termoselagem disponível nas cores creme

## Atornillado interior permite añadir o cambiar hojas o fundas según necesidad del cliente

Screwed interior to include pages or covers, according to the user's needs

Blando · Soft

## Portamenú

Porte-menu  
Speisekartenmappe  
Menu cover  
Porta menu

### Fabricado en simlpiel

Fabriqué en cuir simili - cuir  
Hergestellt aus Lederimitat  
Manufactured in imitation leather  
Fabricado em siml - pele

	Ref	€	cm	Fundas	U.Venta
A	28510	37,70	25,5x32 (A4)	3	4
B	28511	32,10	18x28,5	3	4
C	28512	32,70	19x23,5 (A5)	3	4

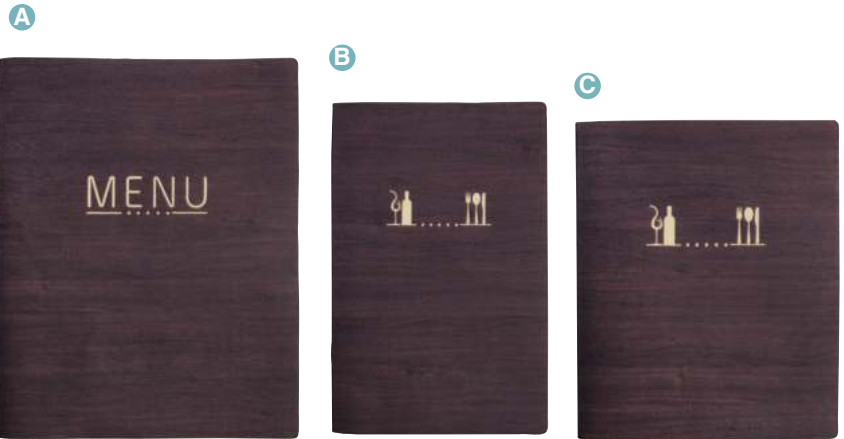

Porta menú  
Menu cover

# ANDRÉ



## Termosellado en color crema

Thermoscellage en couleur crème  
Die Heißprägung ist in den Farben cremefarben  
Heat stamping in cream  
Termoselagem disponível nas cores creme

### Sujeción fija

Fixed clamping

### Fabricado en telflex

Fabriqué en cuir telflex  
Hergestellt aus telflex  
Manufactured in telflex  
Fabricado em telflex

## Portamenú

Porte-menu  
Speisekartenmappe  
Menu cover  
Porta menu

	Ref	€	cm	Fundas	U.Venta
A	28031	21,20	23x32 (A4)	4	4
B	28032	15,90	16x28,5	4	4
C	28033	16,60	17x23,5 (A5)	4	4

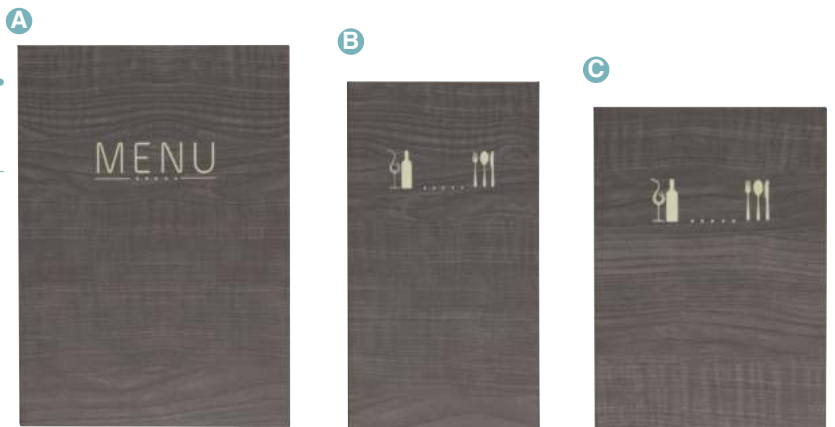

# CÉZANE



## Termosellado en color crema

Thermoscellage en couleur crème  
Die Heißprägung ist in den Farben cremefarben  
Heat stamping in cream  
Termoselagem disponível nas cores creme

### Solapas fijas a la cubierta

Flaps fixed to the cover

### Fabricado en simlpiel

Fabriqué en cuir simili - cuir  
Hergestellt aus Lederimitat  
Manufactured in imitation leather  
Fabricado em siml - pele

## Portamenú

Porte-menu  
Speisekartenmappe  
Menu cover  
Porta menu

	Ref	€	cm	U.Venta
	28041	20,30	23x32 (A4)	4





# LEO



## Termosellado en color crema

Thermoscellage en couleur crème  
Die Heißprägung ist in den Farben cremefarben  
Heat stamping in cream  
Termoselagem disponível nas cores creme

3 solapas transparentes en renoglass 0,40 mm  
3 transparent flaps in renoglass 0.40 mm

**Fabricado en simlpiel**  
Fabriqué en cuir simili - cuir  
Hergestellt aus Lederimitat  
Manufactured in imitation leather  
Fabricado em simil - pele



## Portamenú

Porte-menu  
Speisekartenmappe  
Menu cover  
Porta menu

Ref	€	cm	Solapas	U.Venta
28151	29,50	23x32 (A4)	3	4

# TIZIANO



## Termosellado en color crema

Thermoscellage en couleur crème  
Die Heißprägung ist in den Farben cremefarben  
Heat stamping in cream  
Termoselagem disponível nas cores creme

3 solapas transparentes en renoglass 0,40 mm  
3 transparent flaps in renoglass 0.40 mm

**Fabricado en simlpiel**  
Fabriqué en cuir simili - cuir  
Hergestellt aus Lederimitat  
Manufactured in imitation leather  
Fabricado em simil - pele



## Portamenú

Porte-menu  
Speisekartenmappe  
Menu cover  
Porta menu

Ref	€	cm	Solapas	U.Venta
28172	27,00	17x24 (A5)	3	4

# CLAUDIO



**Con pinza metálica de color plata que sujeta la hoja del menú**  
With a silver-coloured metal clip that holds the menu in place



**Fabricado en simlpiel**  
Fabriqué en cuir simili - cuir  
Hergestellt aus Lederimitat  
Manufactured in imitation leather  
Fabricado em simil - pele



## Portamenú

Porte-menu  
Speisekartenmappe  
Menu cover  
Porta menu

Ref	€	cm	U.Venta
28321	17,00	23,5x33,5(A4)	4

# MATISSE



## Termosellado en color negro

Thermoscellage en couleur noir  
Die Heißprägung ist in den Farben schwarz  
Heat stamping in black  
Termoselagem disponível nas cores negro

**Sujeción fija**  
Fixed clamping

**Fabricado en simlpiel**  
Fabriqué en cuir simili - cuir  
Hergestellt aus Lederimitat  
Manufactured in imitation leather  
Fabricado em símil - pele

## Portamenú

Porte-menu  
Speisekartenmappe  
Menu cover  
Porta menu

	Ref	€	cm	Fundas	U.Venta
A	28051	24,40	23x32 (A4)	4	4
B	28052	18,60	16x28,5	4	4
C	28053	19,50	17x23,5 (A5)	4	4

A



B



C



Porta menú  
Menu cover

# CHARLOTTE



## Termosellado en color negro

Thermoscellage en couleur noir  
Die Heißprägung ist in den Farben schwarz  
Heat stamping in black  
Termoselagem disponível nas cores negro

**Atornillado interior permite añadir o cambiar hojas o fundas según necesidad del cliente**

Screwed interior to include pages or covers, according to the user's needs

**Blando · Soft**

**Fabricado en simlpiel**  
Fabriqué en cuir simili - cuir  
Hergestellt aus Lederimitat  
Manufactured in imitation leather  
Fabricado em símil - pele

## Portamenú

Porte-menu  
Speisekartenmappe  
Menu cover  
Porta menu

	Ref	€	cm	Fundas	U.Venta
A	28530	37,70	25,5x32 (A4)	3	4
B	28531	32,70	18x28,5	3	4
C	28532	32,10	19x23,5 (A5)	3	4

A



B



C



# TOMASSO



## Termosellado en color negro

Thermoscellage en couleur noir  
Die Heißprägung ist in den Farben schwarz  
Heat stamping in black  
Termoselagem disponível nas cores negro

**Atornillado exterior permite añadir hojas o fundas según necesidad del cliente**

Screwed exterior to include pages or covers, according to the user's needs

**Fabricado en simlpiel**  
Fabriqué en cuir simili - cuir  
Hergestellt aus Lederimitat  
Manufactured in imitation leather  
Fabricado em símil - pele

## Portamenú

Porte-menu  
Speisekartenmappe  
Menu cover  
Porta menu

	Ref	€	cm	Fundas	U.Venta
A	28351	25,80	25,5x32 (A4)	3	4
B	28352	21,20	19,5x32	3	4
C	28353	20,00	19x23,5 (A5)	3	4

A



B



C



# DEGAS



## Termosellado en color negro

Thermoscellage en couleur noir  
Die Heißprägung ist in den Farben schwarz  
Heat stamping in black  
Termoselagem disponível nas cores negro

## Solapas fijas a la cubierta

Flaps fixed to the cover

**Fabricado en simlpiel**  
Fabriqué en cuir simili - cuir  
Hergestellt aus Lederimitat  
Manufactured in imitation leather  
Fabricado em simil - pele



## Portamenú

Porte-menu  
Speisekartenmappe  
Menu cover  
Porta menu

Ref	€	cm	U.Venta
28141	22,30	23x32 (A4)	4

# GOYA



## Termosellado en color negro

Thermoscellage en couleur noir  
Die Heißprägung ist in den Farben schwarz  
Heat stamping in black  
Termoselagem disponível nas cores negro

## 3 solapas transparentes en renoglass 0,40 mm

3 transparent flaps in renoglass 0.40 mm

**Fabricado en simlpiel**  
Fabriqué en cuir simili - cuir  
Hergestellt aus Lederimitat  
Manufactured in imitation leather  
Fabricado em simil - pele



## Portamenú

Porte-menu  
Speisekartenmappe  
Menu cover  
Porta menu

Ref	€	cm	Solapas	U.Venta
28161	29,50	23x32 (A4)	3	4

# MARCEL



## Termosellado en color negro

Thermoscellage en couleur noir  
Die Heißprägung ist in den Farben schwarz  
Heat stamping in black  
Termoselagem disponível nas cores negro

## 3 solapas transparentes en renoglass 0,40 mm

3 transparent flaps in renoglass 0.40 mm

**Fabricado en simlpiel**  
Fabriqué en cuir simili - cuir  
Hergestellt aus Lederimitat  
Manufactured in imitation leather  
Fabricado em simil - pele



## Portamenú

Porte-menu  
Speisekartenmappe  
Menu cover  
Porta menu

Ref	€	cm	Solapas	U.Venta
28182	27,00	17x24 (A5)	3	4

# CASSAT



## Termosellado en color negro

Thermoscéllage en couleur noir  
Die Heißprägung ist in den Farben schwarz  
Heat stamping in black  
Termoselagem disponível nas cores negro

## Portamenú

Porte-menu  
Speisekartenmappe  
Menu cover  
Porta menu

**Sujeción fija**  
Fixed clamping

**Fabricado en telflex**  
Fabriqué en cuir telflex  
Hergestellt aus telflex  
Manufactured in telflex  
Fabricado em telflex

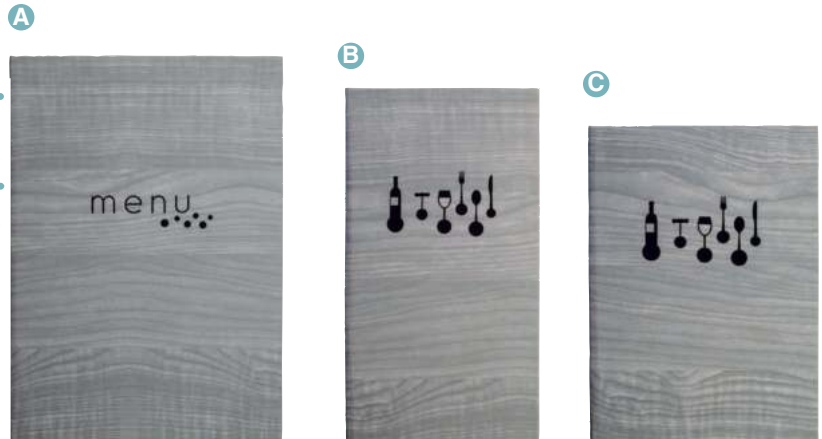

	Ref	€	cm	Fundas	U.Venta
A	28061	21,20	23x32 (A4)	4	4
B	28062	15,90	16x28,5	4	4
C	28063	16,60	17x23,5 (A5)	4	4

# EDGAR



## Termosellado en color negro

Thermoscéllage en couleur noir  
Die Heißprägung ist in den Farben schwarz  
Heat stamping in black  
Termoselagem disponível nas cores negro

## Atornillado exterior permite añadir hojas o fundas según necesidad del cliente

Screwed exterior to include pages or covers, according to the user's needs

**Fabricado en telflex**  
Fabriqué en cuir telflex  
Hergestellt aus telflex  
Manufactured in telflex  
Fabricado em telflex

## Portamenú

Porte-menu  
Speisekartenmappe  
Menu cover  
Porta menu

Ref	€	cm	Fundas	U.Venta
28540	22,40	25,5x32 (A4)	3	4



# MAX



**Con pinza metálica de color plata que sujeta la hoja del menú**  
With a silver-coloured metal clip that holds the menu in place

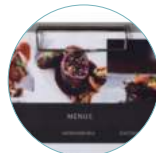

**Fabricado en telflex**  
Fabriqué en cuir telflex  
Hergestellt aus telflex  
Manufactured in telflex  
Fabricado em telflex

## Portamenú

Porte-menu  
Speisekartenmappe  
Menu cover  
Porta menu

Ref	€	cm	U.Venta
28311	13,70	23,5x33,5(A4)	4



# DALÍ



**Termosellado en color blanco**  
 Thermoscellage en couleur blanc  
 Die Heißprägung ist in den Farben weiß  
 Heat stamping in white  
 Termoselagem disponível nas cores branco

## Portamenú

Porte-menu  
 Speisekartenmappe  
 Menu cover  
 Porta menu

**Sujeción fija**  
 Fixed clamping

**Fabricado en simlpiel**  
 Fabriqué en cuir simili - cuir  
 Hergestellt aus Lederimitat  
 Manufactured in imitation leather  
 Fabricado em símil - pele

	Ref	€	cm	Fundas	U.Venta
A	28101	22,70	23x32 (A4)	4	4
B	28102	17,40	16x28,5	4	4
C	28103	18,30	17x23,5 (A5)	4	4

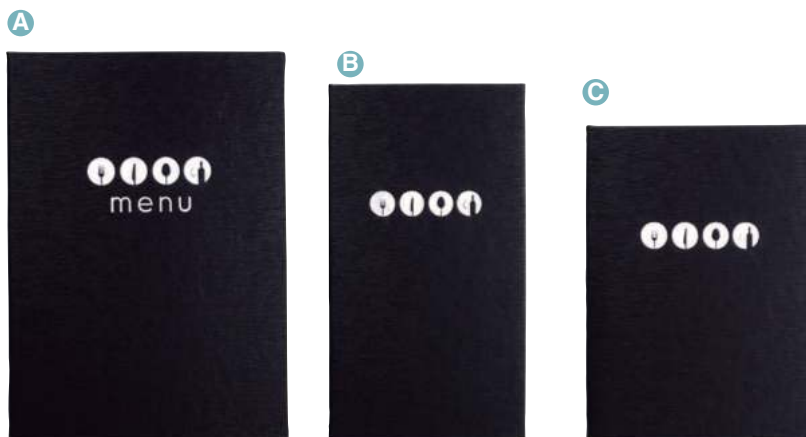

# MARIE



**Termosellado en color blanco**  
 Thermoscellage en couleur blanc  
 Die Heißprägung ist in den Farben weiß  
 Heat stamping in white  
 Termoselagem disponível nas cores branco

## Portamenú

Porte-menu  
 Speisekartenmappe  
 Menu cover  
 Porta menu

**Fabricado en simlpiel**  
 Fabriqué en cuir simili - cuir  
 Hergestellt aus Lederimitat  
 Manufactured in imitation leather  
 Fabricado em símil - pele

**Solapas fijas a la cubierta**  
 Flaps fixed to the cover

	Ref	€	cm	U.Venta
	28560	20,00	23x32 (A4)	4



# FRIDA



**Termosellado en color negro**  
 Thermoscellage en couleur noir  
 Die Heißprägung ist in den Farben schwarz  
 Heat stamping in black  
 Termoselagem disponível nas cores negro

## Portamenú

Porte-menu  
 Speisekartenmappe  
 Menu cover  
 Porta menu

**Sujeción fija**  
 Fixed clamping

**Fabricado en simlpiel**  
 Fabriqué en cuir simili - cuir  
 Hergestellt aus Lederimitat  
 Manufactured in imitation leather  
 Fabricado em símil - pele

	Ref	€	cm	Fundas	U.Venta
A	28011	24,40	23x32 (A4)	4	4
B	28012	18,60	16x28,5	4	4
C	28013	19,50	17x23,5 (A5)	4	4

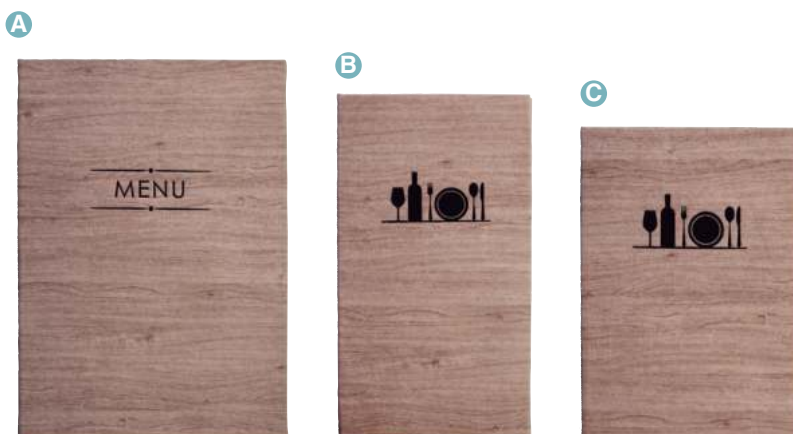

# VERMEER



**Termosellado en color negro**  
Thermoscellage en couleur noir  
Die Heißprägung ist in den Farben schwarz  
Heat stamping in black  
Termoselagem disponível nas cores negro

**Atornillado interior permite añadir o cambiar hojas o fundas según necesidad del cliente**  
Screwed interior to include pages or covers, according to the user's needs

**Blando · Soft**

**Portamenú**  
Porte-menu  
Speisekartenmappe  
Menu cover  
Porta menu

**Fabricado en simipiel**  
Fabriqué en cuir simili - cuir  
Hergestellt aus Lederimitat  
Manufactured in imitation leather  
Fabricado em simil - pele

	Ref	€	cm	Fundas	U.Venta
<b>A</b>	28500	37,70	25,5x32 (A4)	3	4
<b>B</b>	28501	32,10	18x28,5	3	4
<b>C</b>	28502	32,70	19x23,5 (A5)	3	4

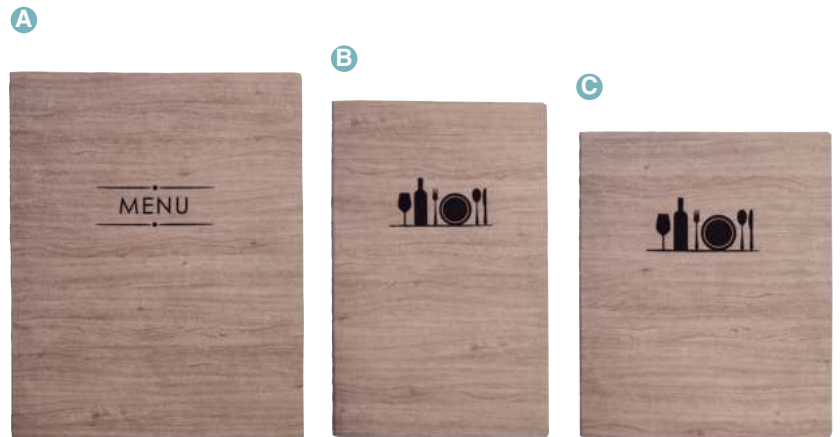

# SOPHIE



**Termosellado en color negro**  
Thermoscellage en couleur noir  
Die Heißprägung ist in den Farben schwarz  
Heat stamping in black  
Termoselagem disponível nas cores negro

**Sujeción fija**  
Fixed clamping

**Portamenú**  
Porte-menu  
Speisekartenmappe  
Menu cover  
Porta menu

**Fabricado en telflex**  
Fabriqué en cuir telflex  
Hergestellt aus telflex  
Manufactured in telflex  
Fabricado em telflex

	Ref	€	cm	Fundas	U.Venta
<b>A</b>	28081	21,80	23x32 (A4)	4	4
<b>B</b>	28082	16,50	16x28,5	4	4
<b>C</b>	28083	17,00	17x23,5 (A5)	4	4

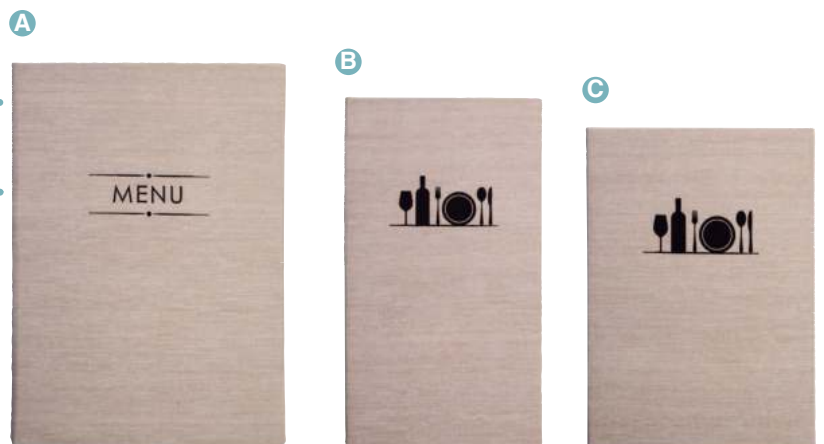

# PAUL

**Termosellado en color negro**  
Thermoscellage en couleur noir  
Die Heißprägung ist in den Farben schwarz  
Heat stamping in black  
Termoselagem disponível nas cores negro

**Atornillado exterior permite añadir hojas o fundas según necesidad del cliente**  
Screwed exterior to include pages or covers, according to the user's needs



**Portamenú**  
Porte-menu  
Speisekartenmappe  
Menu cover  
Porta menu

**Fabricado en telflex**  
Fabriqué en cuir telflex  
Hergestellt aus telflex  
Manufactured in telflex  
Fabricado em telflex

	Ref	€	cm	Fundas	U.Venta
	28550	24,20	25,5x32 (A4)	3	4



# ANDY



## Termosellado en color negro

Thermoscellage en couleur noir  
Die Heißprägung ist in den Farben schwarz  
Heat stamping in black  
Termoselagem disponível nas cores negro

**Sujeción fija**  
Fixed clamping

**Fabricado en simipiel**  
Fabriqué en cuir simili - cuir  
Hergestellt aus Lederimitat  
Manufactured in imitation leather  
Fabricado em simil - pele

## Portamenú

Porte-menu  
Speisekartenmappe  
Menu cover  
Porta menu

	Ref	€	cm	Fundas	U.Venta
<b>A</b>	28271	26,10	23x32 (A4)	4	4
<b>B</b>	28272	20,80	15,5x28	4	4
<b>C</b>	28273	19,70	17x24 (A5)	4	4

**A**



**B**



**C**



# FRANCIS



## Termosellado en color blanco

Thermoscellage en couleur blanc  
Die Heißprägung ist in den Farben weiß  
Heat stamping in white  
Termoselagem disponível nas cores branco

**Fabricado en simipiel**  
Fabriqué en cuir simili - cuir  
Hergestellt aus Lederimitat  
Manufactured in imitation leather  
Fabricado em simil - pele

## Portamenú

Porte-menu  
Speisekartenmappe  
Menu cover  
Porta menu

	Ref	€	cm	Fundas	U.Venta
<b>A</b>	28231	30,00	25x32 (A4)	3	4
<b>B</b>	28232	25,10	18x28	3	4
<b>C</b>	28233	24,20	19,5x23,5 (A5)	3	4

## Atornillado interior permite añadir o cambiar hojas o fundas según necesidad del cliente

Screwed interior to include pages or covers, according to the user's needs

**A**



**B**



**C**



# PABLO



## Termosellado en color blanco

Thermoscellage en couleur blanc  
Die Heißprägung ist in den Farben weiß  
Heat stamping in white  
Termoselagem disponível nas cores branco

**Fabricado en simipiel**  
Fabriqué en cuir simili - cuir  
Hergestellt aus Lederimitat  
Manufactured in imitation leather  
Fabricado em simil - pele

## Portamenú

Porte-menu  
Speisekartenmappe  
Menu cover  
Porta menu

	Ref	€	cm	Fundas	U.Venta
<b>A</b>	28211	30,00	25x32 (A4)	3	4
<b>B</b>	28212	25,10	18x28	3	4
<b>C</b>	28213	24,20	19,5x23,5 (A5)	3	4

## Atornillado interior permite añadir o cambiar hojas o fundas según necesidad del cliente

Screwed interior to include pages or covers, according to the user's needs

**A**



**B**



**C**



# ISABELLE



## Termosellado en color plata

Thermoscellage en couleur argent  
Die Heißprägung ist in den Farben silbern  
Heat stamping in silver  
Termoselagem disponível nas cores prata

**Sujeción fija**  
Fixed clamping

**Fabricado en simlpiel**  
Fabriqué en cuir simili - cuir  
Hergestellt aus Lederimitat  
Manufactured in imitation leather  
Fabricado em simil - pele

## Portamenú

Porte-menu  
Speisekartenmappe  
Menu cover  
Porta menu

	Ref	€	cm	Fundas	U.Venta
A	28001	26,40	23x32 (A4)	4	4
B	28002	19,70	16x28,5	4	4
C	28003	20,70	17x23,5 (A5)	4	4

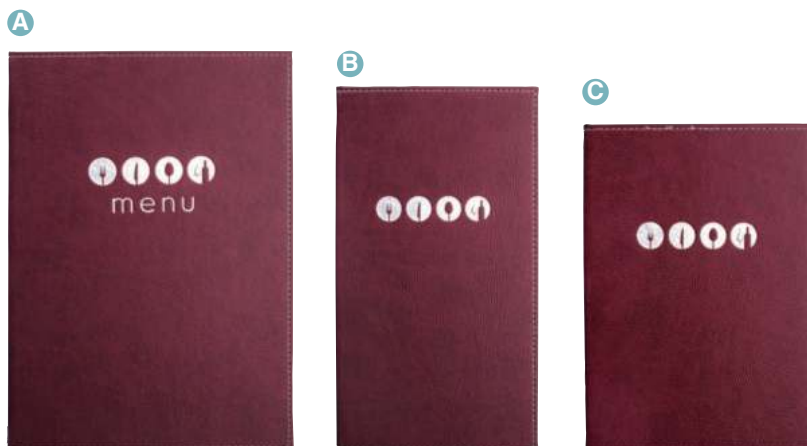

Porta menú  
Menu cover

# MILLET



## Termosellado en color negro

Thermoscellage en couleur noir  
Die Heißprägung ist in den Farben schwarz  
Heat stamping in black  
Termoselagem disponível nas cores negro

**Sujeción fija**  
Fixed clamping

**Fabricado en simlpiel**  
Fabriqué en cuir simili - cuir  
Hergestellt aus Lederimitat  
Manufactured in imitation leather  
Fabricado em simil - pele

## Portamenú

Porte-menu  
Speisekartenmappe  
Menu cover  
Porta menu

	Ref	€	cm	Fundas	U.Venta
A	28131	22,70	23x32 (A4)	4	4
B	28132	17,40	16x28,5	4	4
C	28133	18,30	17x23,5 (A5)	4	4

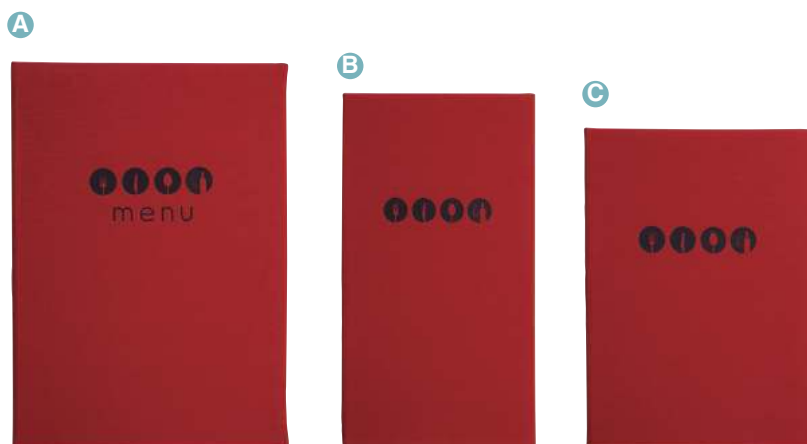

# GEORGIA



**Con pinza metálica de color plata que sujeta la hoja del menú**  
With a silver-coloured metal clip that holds the menu in place



**Fabricado en telflex**  
Fabriqué en cuir telflex  
Hergestellt aus telflex  
Manufactured in telflex  
Fabricado em telflex

## Portamenú

Porte-menu  
Speisekartenmappe  
Menu cover  
Porta menu

	Ref	€	cm	U.Venta
	28396	14,30	23,5x33,5(A4)	4





---

# Corte

Cutting

---





## **Corte** Cutting

# Colección PROFESIONAL

Inox



## Cortador de bolas

Cuillère à pommes  
Kugelausstecher  
Fruit baller  
Cortador bolas

Ref	€	Ø (mm)	U.Venta
60366	7,60	15	1
60367	7,70	20	1
60368	7,70	25	1
60369	7,80	30	1



## Cortador de bolas oval rizado

Cuillère à pommes forme oval canelée  
Kugelausstecher oval, gerippt  
Fruit baller oval fluted  
Cortador bolas oval frizado

Ref	€	mm	U.Venta
60372	8,50	20x32,5	1



## Pelapatatas "Y"

Eplucheur "Y"  
"Y" Schäler  
"Y" Peeler  
Pela-batatas "Y"

Ref	€	mm	U.Venta	
60377	9,50	55x55	1	Liso · Plane
60378	10,10	55x55	1	Dentado · Serrated



## Pelapatatas "P"

Eplucheur "P"  
"P" Schäler  
"P" Peeler  
Pela-batatas "P"

Ref	€	mm	U.Venta
60380	6,60	16x55	1



## Pelador cuchilla fija

Éplucheur lame fixe  
Schälter Messerfix  
Fix blade peeler  
Pela-batatas lâmina fixa

Ref	€	mm	U.Venta
60398	5,20	15x75	1



## Cuchillo vaciador

Couteau pour fruits  
Frucht messer  
Fruit knife  
Faca para fruta

Ref	€	mm	U.Venta
60399	6,00	20x105	1



# Colección LUXE

Inox



## Cuchillo para queso

Couteaux à fromage  
Käsemesser  
Cheese knife kitchen tool  
Faca para queijo

Ref	€	cm	L (cm)	U.Venta
62675	11,40	14	28	6

## Espátula lisa

Spatule lisse  
Backschaufel  
Spatula  
Espátula

Ref	€	cm	L (cm)	U.Venta
62676	9,70	4,3x11	25	6



## Descorazonador

Vide-pommes  
Apfelentkerner  
Aple corer  
Descaroçador

Ref	€	cm	L (cm)	U.Venta
62686	9,90	2x2	20	6



## Cortador de bolas

Cuillère à pommes  
Kugelausstecher  
Fruit baller  
Cortador de bolas

Ref	€	cm	L (cm)	U.Venta
62683	8,90	3x1	19	6



## Pelapatatas "Y"

Eplucheur "Y"  
"Y" Schäler  
"Y" Peeler  
Descascador de batatas "Y"

Ref	€	cm	L (cm)	U.Venta
62687	11,60	5x2	18	6



## Pelapatatas "P"

Eplucheur "P"  
"P" Schäler  
"P" Peeler  
Descascador de batatas "P"

Ref	€	cm	L (cm)	U.Venta
62688	10,60	2x1	20	6



## Pala pastel serrada

Palette à gâteau dentellé  
Kuchenschaufel  
Serrated cake shovel  
Espátula de bolos c/serrilha

Ref	€	cm	L (cm)	U.Venta
62673	12,60	5,5x13	26	6



Inox  
18/10

## Abre ostras LUXE

Couteau à huîtres  
Austermesser  
Oyster opener  
Aberto-ostras

Ref	€	L (cm)	U.Venta
62684	12,60	20	1



## Prensa ajos

Presse-pail  
Knoblauchpresse  
Garlic press  
Esmaga-alhos

Ref	€	cm	L (cm)	U.Venta
62685	24,00	3x5	18	6



## Abrelatas

Ouvre-boîte  
Dosenöffner  
Can opener  
Abre-latas

	Ref	€	cm	L (cm)	U.Venta
A	62689	26,50	5x4	20	6
B	63038	22,20	5x4	17	1



# Colección PELADORES

Inox

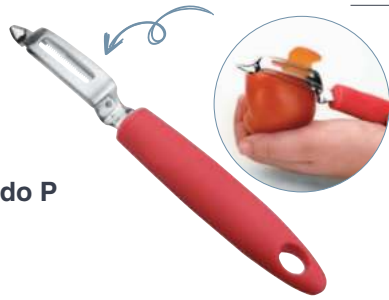

## Pelador tomate dentado P

Épluche tomates à dents P  
Tomatenschäler, gezackt, P  
P Serrated tomato peeler  
Pelador tomate dentado P

Ref	€	L (cm)	U.Venta
60351	14,30	19,5	1



## Pelador tomate dentado T

Épluche tomates à dents T  
Tomatenschäler, gezackt, T  
T Serrated tomato peeler  
Pelador tomate dentado T

Ref	€	L (cm)	U.Venta
60352	14,00	17,5	1

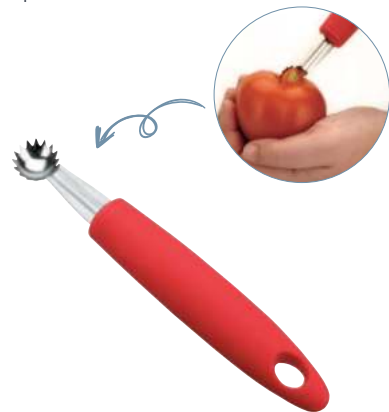

## Descorazonador

Vide tomates  
Tomatenentkerner  
Tomato core remover  
Descorçador

Ref	€	L (cm)	U.Venta
60353	10,70	16,5	1

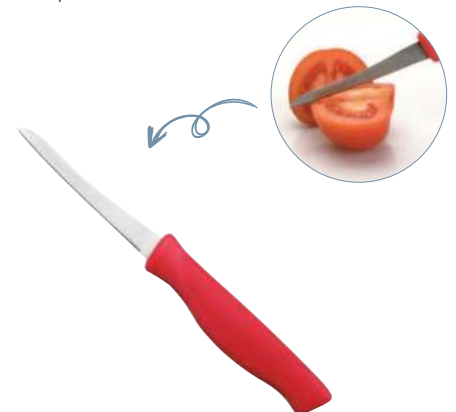

## Cuchillo dentado

Couteau à dents à tomates  
Tomatenmesser, gezahnt  
Serrated tomato knife  
Faca dentada

Ref	€	L (cm)	U.Venta
60354	10,60	22	1

TPE

Mango/Handle



## Pelador liso

Éplucheuse plate  
Normalen Schäler  
Peeler plain blade  
Descascador liso

Ref	€	L (cm)	U.Venta
60547	10,90	12,5	1

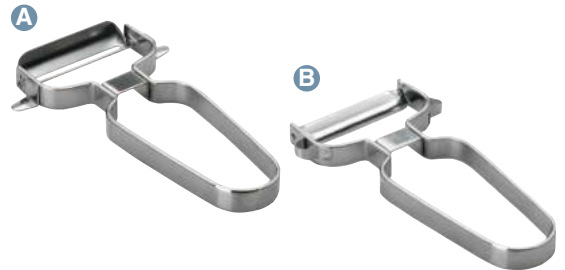

## Pelador

Éplucheuse  
Schäler  
Peeler  
Descascador

	Ref	€	cm	U.Venta	
A	60346	11,90	5,5x12	1	Liso · Plane
B	60347	11,90	5,5x12	1	Dentado · Serrated

Girando la cuchilla es apto para diestros y zurdos  
Turning the blade it is suitable for right- and left-handed individuals



Inox Cuchilla Blade  
PP Polypropylene  
HAYA Beech Wood

## Pelador UNITE

Éplucheuse  
Schäler  
Peeler  
Descascador

	Ref	€	L (cm)	U.Venta	
A	68197	4,20	14,5	1	Liso · Plain
B	68198	4,20	14,5	1	Dentado · Serrated

Cuchilla cerámica  
ceramic blade

PP Polypropylene  
Dishwasher  
BPA free



Mango SOFT TOUCH  
SOFT TOUCH handle

## Pelador cerámico Y

Éplucheuse en céramique Y  
Y Schäler, Keramik  
Y ceramic peeler  
Descascador cerámico Y

Ref	€	cm	U.Venta
60444	4,00	8,5x16,5	6



3 en 1  
3 in 1

### Pelador "P" 3 cuchillas giratorias

Éplucheuse "P" 3 lames tournantes  
"P" Schäler, 3 rotierende Messer  
"P" type peeler 3 rotating blades  
Descascador "P" 3 lâminas giratórias

Ref	€	L (cm)	U.Venta
60388	22,60	20	1



3 en 1  
3 in 1

### Pelador "Y" 3 cuchillas giratorias

Éplucheuse "Y" 3 lames tournantes  
"Y" Schäler, 3 rotierende Messer  
"Y" type peeler 3 rotating blades  
Descascador "Y" 3 lâminas giratórias

Ref	€	L (cm)	U.Venta
60389	23,50	20	1



5 en 1  
5 in 1

### ABS

Plastic

### Pelador aguacate

Coupe avocat  
Schäler avocado  
Avocado peeler  
Descascador abacate

Ref	€	cm	U.Venta
61355	8,60	28x4	1

#### Triturador con ranuras

Disposer with rabbet

#### Cuchara

Spoon

#### Funda protectora

Protective



#### Dientes

Teeth

#### Cuchillo

Knife

#### Adaptador extrahuesos

Sixtrat bones adapter



### Inox TPE

Cuchilla

Hilos/Threads Plastic

### Laminador de aguacate

Éplucheuse avocats  
Schäler avocados  
Avocado slicer  
Descascador abacater

Ref	€	cm	L (cm)	U.Venta
61353	11,80	6,2	24	1

### ABS

Plastic

### Pelador de piña

Set coupe ananas  
Ananas-Schäler  
Pineapple peeler  
Pelador de ananas

Ref	€	Ø (cm)	h (cm)	U.Venta
60392	11,30	10	23	4



### ABS

Plastic

### Juego cortador-pelador piña con base

Jeu couteau et éplucheur ananas  
Messer und Schäler set für ananas  
Set pineapple cutter-peeler with canister  
Jogo cortador e descascador de ananas

Ref	€	Ø (cm)	U.Venta
60393	24,60	9	1

3 en 1  
3 in 1



# Colección PICADORES

Inox  
18/10



- Picadora de mecanismo manual que pica todo tipo de alimentos, como verduras, frutas, jengibre, ajo, cebolla, frutos secos y hierbas.
- Cuchilla de acero inoxidable de máxima calidad.
- Recipiente transparente para visualizar el proceso. Libre de BPA.
- Muy fácil y cómodo de usar gracias a su sistema manual PressTurn.
- Tapa de polietileno antideslizante para facilitar la tarea y evitar desplazamientos.
- Fácil de desmontar y limpiar.

- Hachoir à mécanisme manuel qui hache tout type d'aliments, comme les légumes, les fruits, le gingembre, l'ail, l'oignon, les fruits secs et les herbes.
- Lame en acier inoxydable de la plus grande qualité.
- Récipient transparent. Sans BPA.
- Très facile et pratique à utiliser grâce à son système manuel **PressTurn**.
- Couvercle antidérapant pour faciliter la tâche et éviter les glissements.
- Facile à démonter et à nettoyer.

- Handschneider zum Zerkleinern von Gemüse, Obst, Ingwer, Knoblauch, Zwiebeln, Dörrobst, Kräutern usw.
- Messer aus rostfreiem Stahl bester Qualität.
- Arbeitsfortschritt im Klarsichtbehälter zu sehen. Ohne BPA.
- Einfach und bequem per **PressTurn** von Hand zu bedienen.
- Kompakte Form: Griff lässt sich zum Aufbewahren platzsparend befestigen.
- Müheloses und sicheres Arbeiten dank rutschfestem Deckel. Teile einfach abnehmbar und zu reinigen.

- Hand-operated food processor for chopping all types of food, such as vegetables, fruit, ginger, garlic, onion, nuts and herbs.
- Top quality stainless steel blade.
- Transparent jar for easy viewing. BPA free.
- Very simple, easy to use manual **PressTurn**.
- Non-slip lid to simplify the process and avoid slipping.
- Easy to dismantle and clean.

- Picadora de mecanismo manual para picar todo o tipo de alimentos, como verduras, frutas, gengibre, alho, cebola, frutos secos e ervas aromáticas.
- Lâmina de aço inoxidável da máxima qualidade.
- Recipiente transparente para visualizar o processo. Não contém BPA.
- Muito fácil e cómodo de usar, graças ao seu sistema manual **PressTurn**.
- Tampa antideslizante, para facilitar o trabalho e evitar deslizamentos.
- Fácil de desmontar e de limpar.



Diseño compacto  
Compact design



## Picadora manual PRESS

Hachoir manuel  
Handschneider  
Manual food chopper  
Picador manual

Ref	€	Ø (cm)	h (cm)	U.Venta
62819	35,70	9,4	22,7	1

## Picadora manual

Hachoir manuel  
Handschneider  
Manual food chopper  
Picador manual

Ref	€	Ø (cm)	h (cm)	U.Venta
62980	31,90	9,5	22	6



## Picaperejil

Hachoir à manivelle pour fines herbes  
Kräutermühle, fein, Rostfrei  
St. steel fine herbs mincer  
Pica-salsa



Ref	€	cm	U.Venta
60334	22,30	13,5x20x7,5	1

## Inox

## Picadora de carne manual

Hachoir avec manivelle  
Fleischwolf mit handkurbe  
Meat mincer  
Picadora de carne manual

Ref	€	cm	U.Venta
60329	123,80	17x12x19	1



Inox **ABS**  
Plastic

## Picadora

Mincer  
Fleischwolf  
Hachoir  
Picadora

Ref	€	cm	U.Venta
60340	34,70	18x22	1

**Sistema TurnCut**  
**Accionamiento manual**  
de la manivela  
TurnCut System  
Manual crank operation



**Cuchillas de acero inoxidable**  
Stainless steel blades



**Empujador, facilita y agiliza el proceso**  
Pusher, facilitates and speeds up the process

**100% estable. Sujeción mediante ventosa**  
100% Stable  
Suction cup fastening

**Mecanismo de manivela que requiere muy poca fuerza**  
Crank mechanism requiring very little force

**Multifuncional; Pica, bate y centrifuga**  
Multifunctional; Chop, beat and spin



## Mini picadora-batidora manual

Mini hachoir-fouet manuel  
Minizerhacker-Schneebeisen  
Manual mini chooper-whisk  
Mini picadora-batedeira manual

Ref	€	Ø (cm)	L	U.Venta
60361	18,10	Ø17x18	1,00	1

## Garras de OSO

new

Inox

Baquelita  
Bakelite  
Mangos  
Handleise



Dishwasher

**Manipula carnes**  
Manipulate meat



**Desmenuza carnes**  
Crumble meats

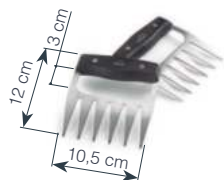

- Fabricadas en acero inoxidable de máxima calidad.
- Diseñadas para desmenuzar y manipular carnes hechas al horno o barbacoa, como pollo, carne de vacuno, pavo, aves, jamón, etc.
- Puntas afiladas para manipular la carne sin esfuerzo. Forma curvada para un mejor agarre y mayor comodidad.
- Mangos ergonómicos de baquelita resistentes al calor, 100% seguros.
- Multifuncional: desmenuza y traslada la carne, facilita la sujeción para cortes con cuchillo, remueve las ensaladas o pastas, etc.
- Fácil de limpiar. Aptas para el lavavajillas.

- Fabriquées en acier inoxydable de la plus grande qualité.
- Conques pour émincer et manipuler des viandes cuites au four ou au barbecue comme du poulet, du boeuf, de la dinde, de la volaille, du jambon, etc.
- Pointes aiguisées pour manipuler la viande sans effort. Forme courbée pour une meilleure prise en main et un plus grand confort.
- Poignées ergonomiques en bakélite résistantes à la chaleur, 100% sûres.
- Multifonctions : émincer et transférer la viande, faciliter la prise en main pour une découpe au couteau, remuer les salades ou les pâtes, etc.
- Facile à nettoyer. Aptes pour le lave-vaisselle.

- Made of top quality stainless steel.
- Designed for shredding and handling baked or barbecued meats, such as chicken, beef, turkey, poultry, ham, etc.
- Sharp tips for easy handling of meats. Curved shape for better grip and comfort.
- Ergonomic heat-resistant Bakelite handles, 100% safe.
- Multifunctional: perfect for shredding, turning and holding meat in place while cutting it with a knife, ideal for mixing salads or pasta, etc.
- Easy to clean. Dishwasher safe.

## Garras de oso para carne

Griffes à viande  
Fleisch Bärenkrallen  
Bear claws for meat  
Garras de urso para carne

Ref	€	cm	U.Venta
38015	12,70	10,5x12	1



# Cortadores en **ESPIRAL**

Inox

TPR



Plastic

Dishwasher

BPA Free



- Corta frutas y verduras en forma de tallarines.
- Ideal para calabacín, zanahoria, nabo, patata, remolacha etc.
- Alimentación saludable y baja en hidratos de carbono.
- Cuchillas de acero inoxidable. Se utiliza del mismo modo que un sacapuntas.

- Coupe les fruits et les légumes en forme de tagliatelles.
- Idéal pour les courgettes, carottes, navets, pommes de terre, betteraves, etc.
- Alimentation saine et faible en hydrates de carbone.
- Lames en acier inoxydable. S'utilise comme un taille-crayon.

- Schneidet Obst und Gemüse in Nudelform.
- Ideal für Zucchini, Karotten, Rüben, Kartoffeln, Rote Beete, usw.
- Gesunde Ernährung, arm an Kohlehydraten.
- Messer aus rostfreiem Stahl. Es wird in gleicher Weise wie ein Anspitzer verwendet.

- Slice fruit and vegetables into noodleshapes.
- Ideal for courgettes, carrots, turnips, potatoes, beetroot, etc.
- Healthy and low carbohydrate food.
- Stainless steel blades. Works just like a pencil sharpener.

- Corta frutas e verduras em forma de talharins.
- Ideal para courgette, cenoura, nabo, batata, beterraba, etc.
- Alimentação saudável e baixa em hidratos de carbono.
- Lâminas de aço inoxidável. Utiliza-se como um afiador de lápis.



## Cortador en espiral espagueti

Coupe en spirale  
Spiralschneider  
Spiral cutter  
Cortador em espiral

Ref	€	Ø Int. (cm)	Cuchilla L (cm)	U.Venta
60529	4,00	8	5,5	6



Incluye un contenedor-empujador  
Includes a pusher container



Cubiertos  
Cutlery

## Cortador en espiral manual

Coupe en spirale manuelle  
Manueller Spiralschneider  
Manual spiral cutter  
Cortador em espiral manual

Ref	€	Ø (cm)	h (cm)	L	U.Venta
60524	18,60	9	22	0,40	1



## Cortador en espiral liso

Coupe en spirale lisse  
Spiralschneider, glatt  
Plain spiral cutter  
Cortador em espiral liso

Ref	€	Ø Int. (cm)	Cuchilla L (cm)	U.Venta
60528	4,00	8	5,5	6



## Cortador en espiral dentado

Coupe en spirale dentée  
Spiralschneider, gezähnt  
Serrated spiral cutter  
Cortador em espiral dentado

Ref	€	Ø Int. (cm)	Cuchilla L (cm)	U.Venta
60527	4,00	8	5,5	6

# Colección CORTADORES



- Picadora de mecanismo manual que pica todo tipo de alimentos, como verduras, frutas, frutos secos, dátiles, jengibre, ajo, cebolla, hierbas, etc.
- Incluye tres potentes cuchillas ultrarresistentes fabricadas en acero inoxidable de máxima calidad.
- Ajuste de dos velocidades: velocidad baja (I) para cortar y picar más grueso y velocidad alta (II) para un corte y picado más fino (60599).
- Práctico y muy fácil de usar: con tal solo tirar del asa las cuchillas se activan.
- Corta con precisión y homogéneamente.
- Asa ergonómica y base antideslizante 100% segura.
- Ocupa poco espacio ya que su asa-tirador se pliega sobre la tapa de la picadora.
- Pequeño, compacto y muy fácil de limpiar.

- Hachoir à mécanisme manuel qui hache tout type d'aliments, comme les légumes, les fruits secs, les dattes, le gingembre, l'ail, les oignons, les herbes, etc.
- Il possède trois puissantes lames ultra-résistantes fabriquées en acier inoxydable de la plus grande qualité.
- Réglage de deux vitesses: Vitesse faible (I) pour couper et hacher plus épais, et vitesse haute (II) pour couper et hacher plus finement (60599).
- Pratique et très facile à utiliser : il suffit de tirer de la poignée pour activer les lames.
- Coupe avec précision et de façon homogène.
- Poignée ergonomique et base antidérapante 100% sûre.
- Prend peu de place car sa poignée se replie sur le couvercle du hachoir.
- Petit, compact et très facile à nettoyer.

- Manual chopper that chops all kinds of food, like vegetables, fruit, nuts, dates, ginger, garlic, onion, herbs, etc.
- It includes three ultra-strong blades made of top quality stainless steel.
- There are two speed settings: Low speed (I) is for cutting and chopping more coarsely and high speed (II) is for cutting and chopping more finely (60599).
- Practical and very easy to use: The blades are activated by simply pulling the handle.
- It cuts precisely and evenly.
- It has an ergonomic handle and a 100% safe non-slip base.
- It doesn't take up much space because the handle-pull folds onto the chopper lid.
- It's small, compact and very easy to clean.

**Pica y corta alimentos en segundos**  
It chops and slices foods in seconds



**3 cuchillas ultrarresistentes**  
3 ultra-strong blades

**5 cuchillas ultrarresistentes**  
5 ultra-strong blades



## Cortador manual SHARP

Coupe manuel  
Manueller Schneider  
Manual cutter  
Cortador manual

	Ref	€	Ø (cm)	h (cm)	L	U.Venta
A	60299	21,10	12	11	0,5	1
B	60499	22,40	13	14	1,0	1

**II**  
**Velocidad I - Speed I**  
**Corta y pica más grueso**  
Cut and chop more coarsely

**II**  
**Velocidad II - Speed II**  
**Corta y pica más fino**  
Cut and chop more finely

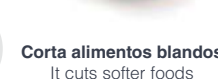
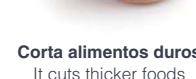

**Corta alimentos duros**  
It cuts thicker foods

**Corta alimentos blandos**  
It cuts softer foods

**Cuchillas SpinPro ultrarresistentes de acero inoxidable**

SpinPro blades ultra-resistant stainless steel

## Cortador manual AFFILATO

Coupe manuel  
Manuelle Schneider  
Manual chopper  
Cortador manual

	Ref	€	Ø (cm)	h (cm)	L	U.Venta
	60599	24,90	13	14	1,2	1





## Cortador de verdura y chips

Coupe de légumes  
Gemüseschneidmaschine  
Chips and vegetable cutter  
Cortador de verdura e chips

Ref	€	cm	h (cm)	U.Venta
60344	45,30	11,5x21,5	11	1



## Cortador de patatas HASSELBACK

Coupe-pommes de terre Hasselback  
Hasselback-Kartoffelschneider  
Hasselback potato slicer  
Cortador de batatas Hasselback

Ref	€	cm	h (cm)	U.Venta
68180	9,60	18x10	2,1	1



## Deshojador de hierbas aromáticas

Effeulleuse à herbes aromatiques  
Entblätterer für gewürzkräuter  
Aromatic herb stripper  
Desfolhador de ervas aromáticas

Ref	€	cm	U.Venta
61359	6,50	16,5x7,5x2	1

- 2 en 1: cortador de verduras y cortador para preparar patatas Hasselback.
- Ideal para cortar en rodajas cualquier tipo de alimento como patata, cebolla, tomate, pepino, zanahoria e incluso carne y pescado.
- Mango antideslizante para un agarre firme y pinchos que guían el cuchillo para un corte perfecto y uniforme.
- Fácil de limpiar. Apto para el lavavajillas.

- 2 en 1 coupe-légumes et coupe-pommes de terre pour préparer des pommes de terre Hasselback.
- Idéal pour couper en rondelles tout type d'aliments comme les pommes de terre, les tomates, les concombres, les carottes et même la viande et le poisson.
- Manche antidérapant pour une prise en main ferme et des pointes qui guident le couteau pour une découpe parfaite et uniforme.
- Facile à nettoyer. Convient au lave-vaisselle.

- 2 in 1: vegetable slicer and Hasselback potato slicer.
- Ideal for slicing any type of food such as potatoes, onions, tomatoes, cucumbers, carrots and even meat and fish.
- Non-slip handle for a firm grip and skewers that guide the knife for perfect and even slicing.
- Easy to clean. Suitable for the dishwasher.

- Funcionamiento sencillo; insertar el tallo en el agujero que mejor se adapte y deslizar la rama en dirección contraria.
- Contiene agujeros de distinto tamaños:
  - a.- Los pequeños para deshojar hierbas aromáticas como el romero, orégano, tomillo estragón, etc.
  - b.- Los más grandes para separar el tallo más duro que tienen algunas verduras de la hoja como las acelgas, espinacas, col rizada, etc.
- Gracias a la parte más aguda, se pueden cortar las hojas con el mismo utensilio.

- Fonctionnement simple : insérer la tige dans le trou qui s'adapte le mieux et faire glisser la branche dans le sens contraire.
- Contient des trous de différentes tailles :
  - a.- Les petits; servent à effeuiller les herbes aromatiques telles que le romarin, l'origan, le thym, l'estragon, etc.
  - b.- Les plus grands; servent à séparer la tige plus dure de certains légumes comme les blettes, les épinards, le chou frisé, etc.
- Grâce à la partie plus pointue, les feuilles peuvent être coupées avec le même ustensile.

- Easy to use. Put the stalk into the hole where it fits best and pull the herb in the opposite direction.
- There are different sized holes:
  - a.- The small holes are for stripping leaves from aromatic herbs like rosemary, oregano, thyme, tarragon, etc.
  - b.- The bigger holes are for separating harder stalks found in some leafy vegetables like chards, spinach, kale, etc.
- With the sharp end you can use the same utensil to cut leaves.

Inox



### Corta verduras manual doble cuchilla

Hachoir de légumes double manuel  
Doppelschneidiges Hand Wiegemesser  
Vegetables manual double blade chopper  
Corta verduras manual duplo lâmina

Ref.	€	cm	U.Venta
60365	16,60	17x2	10

Inox  
18/10



### Cortabacalao

Couper la morue  
Kabeljau-Schneider  
Cut cod  
Corta-bacalhau

Ref.	€	cm	U.Venta
60000	241,70	11x58,5x8	1

Inox  
18/10



### Cortaquesos cuchilla

Coupe-fromage avec lame  
Käsemesser, mit Klinge  
Cheese cutter with blade  
Corta-queijos lâmina

Ref.	€	cm	h (cm)	U.Venta
60005	28,80	27,5x21	3	1

Inox

### Cortador de queso fresco

Fromage coupe fil  
Draht-Käseschneider  
Cheese wire cutter  
Corta-queijos

Ref.	€	cm	U.Venta
60004	4,80	17	12
60009	5,30	21	12

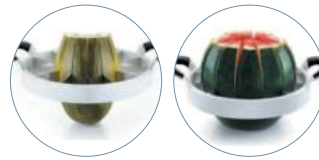
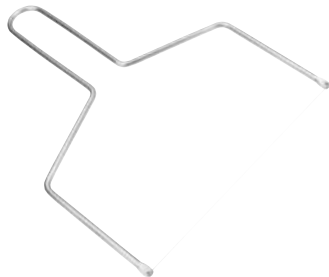

Inox

TPR  
PP  
Plastic Polypropylene

### Corta melones-sandias

Trancheur à melons  
Wassermelonen-Schneider  
Melon cutter-watermelon  
Corte os melões-melancia

Ref.	€	Ø (cm)	U.Venta
60397	20,10	25,0	1

Inox

TPR  
Plastic

### Descorazonador manual

Vide-pommes manuel  
Apfelentkerner  
Manual apple corer  
Descorçador manual

Ref.	€	U.Venta
60350	7,70	1



Zamak  
Zinc Alloy

### Cortahuevos doble uso DUAL

Coupe-oeuf 2 utilisations  
Eirschneider, 2-teilig  
2 way egg cutter  
Corta-ovos duplo uso

Ref.	€	Ø (cm)	U.Venta
68305	20,00	7	1



Inox

### Cortahuevos

Coupe-oeuf en inox  
Eirschneider, Rostfrei  
St. steel egg slicer  
Corta-ovos

Ref.	€	Ø (cm)	U.Venta
68306	18,00	10	12



Inox

### Cortahuevos doble uso

Coupe-oeuf 2 utilisations  
Eirschneider, 2-teilig  
2 way egg cutter  
Corta-ovos duplo uso

Ref.	€	cm	U.Venta
68307	35,50	15x10x3,7	1



**Guían el cuchillo para un corte perfecto y uniforme**  
Guide the knife for perfect and even slicing

Inox



**Peine cortacarne**

Peigne pour coupe viande  
Fleischzange  
Meat tong  
Pinça/pente corta-carne

Ref	€	cm	h (cm)	U.Venta
60336	19,70	11x30	6,5	6



**2 en 1: rallador y laminador de queso**

2 in 1: cheese grater and laminator

**Regulador de espesor**  
Thickness regulator



Inox **TPR**  
Plastic

**Rallador-laminador de queso**

Râpe et laminoir pour le fromage  
Reibe/Schneider für Käse  
Cheese grater-cutter  
Ralador e laminador para queijo

Ref	€	L (cm)	U.Venta
61352	16,30	23,50	1

**Simple, práctico y muy efectivo**  
Simple, practical and very effective

Inox

**Laminador de trufa**

Coupe-Truffles  
Truffelschneider  
Truffe-slicer  
Laminador trufa

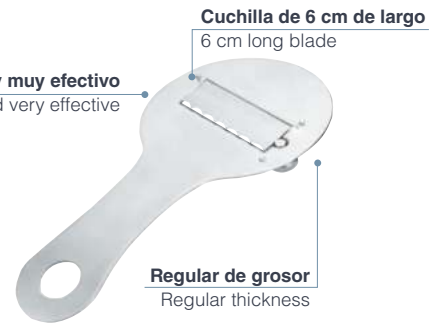

Ref	€	L (cm)	U.Venta
61351	14,40	18	1



Inox

**Inox 18/10**

**Cortapizza**

Roulette pizza  
Pizzaschneider  
Pizza cutter  
Corta-Pizza

	Ref	€	Ø (cm)	U.Venta
<b>A</b>	60429	5,00	10	12
<b>B</b>	67004	17,50	10	6
<b>C</b>	67028	12,10	10	1
<b>D</b>	67027	5,80	8	6

Triturador manual de **TOMATE**

*new*

Inox **ABS SAN LDPE**  
Plastic Plastic Container Polyethylene Tapa/Lid **BPA free**



**Incluye empujador**  
Includes pusher

**Salida para desechos**  
Outlet for waste



**Salida de jugo, libre de pieles y semillas**  
Juice outlet with no peels or seeds



- Saca el máximo jugo a los alimentos, libre de pieles y semillas.
- Filtro de acero inoxidable de gran calidad y contenedor de polipropileno, libre de BPA.
- Superversátil: prepara salsas de tomate, purés de patata, mermeladas, conservas, etc. con un único aparato.
- Entrada de alimentación de gran capacidad.
- Dispone de un orificio de salida para desechos.
- 100% estable: sistema de sujeción mediante ventosa.
- Incluye empujador para facilitar y agilizar el procesado.
- Totalmente desmontable y fácil de limpiar.

- Recueillir au maximum le jus des aliments, sans peaux ni pépins.
- Filtre en acier inoxydable de grande qualité et conteneur en polypropylène, sans BPA.
- Très polyvalent: préparer des sauces tomate, des purées, des confitures, des conserves, etc. avec un seul appareil.
- Entrée d'aliments de grande capacité.
- Dispose d'un orifice de sortie pour déchets.
- 100% stable: système de fixation via des ventouses.
- Inclut un poussoir pour faciliter et accélérer le processus.
- Entièrement démontable et facile à nettoyer. Compatible lave-vaisselle.

- Designed to get the most juice out of food with no peels or seeds.
- It has a high quality stainless steel filter and a BPA free polypropylene container.
- Extremely Versatile: make tomato sauces, potato purée, marmalade, preserves, etc. with a single appliance.
- High capacity food input
- It has an outlet for waste.
- 100% Stable: it has an attachment system that uses suction cups.
- A pusher is included to make processing food faster and easier.
- It can be completely disassembled and it's very easy to clean.

**Triturador manual de tomate**

Presse-tomates manuel  
Handpresse für Tomaten  
manual tomato chopper  
Triturador manual de tomate

Ref	€	U.Venta
60394	47,20	1

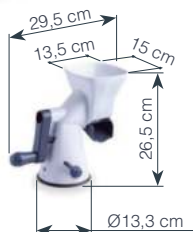

# Ralladores 4 / 6 CARAS



- Fabricados en acero inoxidable de máxima calidad. Robustos y altamente resistente.
- Disponen de 4/6 caras de distinto corte para obtener el tipo de rallado deseado: fino, medio, grueso y cortes en rodajas.
- Diseñados para rallar y cortar en rodajas todo tipo de alimentos como queso, verduras, nuez moscada, chocolate, etc.
- Asa ergonómica para un mejor agarre y uso.
- Prácticos y muy fáciles para almacenar.



- Fabriquées en acier inoxydable de la plus grande qualité. Robustes et hautements résistante.
- Disposant de 4/6 faces différentes pour obtenir la coupe et le type de grain souhaité : fin, moyen, épais et différentes coupes en rondelles.
- Conçue pour râper tout type d'aliments comme du fromage, des légumes, de la noix de muscade, du chocolat, etc.
- Poignée ergonomique pour une meilleure prise en main et utilisation.
- Pratique et très facile à ranger.

- Hergestellt aus hochwertigem Edelstahl. Robust und sehr widerstandsfähig.
- Es hat 4/6 Seiten mit unterschiedlichen Schnitten, und Scheiben: fein, mittel, grob und Schnitte geschnitten.
- Entwickelt zum Reiben und Schneiden aller Arten Lebensmittel wie Käse, Gemüse, Muskat, Schokolade usw.
- Ergonomischer Griff für Besseres greifen und verwenden.
- Praktisch und sehr einfach zu verstauen.

- Made of top quality stainless steel. Robust and highly resistant.
- Features 4/6 different cutting sides to suit all your grating needs: fine, medium, coarse and slices.
- Designed to grate and slice all kinds of food such as cheese, vegetables, nutmeg, chocolate, etc.
- Ergonomic handle for better grip and use.
- Very practical and easy to use.

- Fabricados em aço inoxidável da máxima qualidade. Robustos e altamente resistentes.
- Com 4/6 faces de corte diferentes, para obter o tipo de raladura desejado: fina, média, grossa e diferentes cortes em rodela.
- Pensado para ralar todo o tipo de alimentos, como queijo, verduras, noz-moscada, chocolate, etc.
- Asa ergonómica para uma melhor sujeição e maior facilidade de utilização.
- Prático e fácil de armazenar.

Corte  
Cutting

Asa de haya 100% natural  
100% natural beech handle

**Haya**  
Beech  
wood

## Rallador 4 caras WOOD

Râpe 4 faces  
4-seitige Reibe  
4-sided grater  
Ralador 4 lados



	Ref	€	cm	h (cm)	U.Venta
A	61364	11,00	11x8,5	24,8	1
B	61365	9,10	9x6,5	22,0	1

Contenedor de 250 ml.  
Marcado en ml y cups  
250 ml container.  
Marked in ml and cups

**ABS** PS  
Plastic Polystyrene  
Contenedor Container  
BPA free

## Rallador 4 caras con recipiente KEEP

Râpe 4 faces avec récipient  
4-seitige Reibe mit Behälter  
4-sided grater with container  
ralador 4 lados com recipiente



	Ref	€	cm	h (cm)	U.Venta
	61363	6,10	8,9x6,5	20,5	61

**Inox**  
18/10

## Rallador

Râpe  
Reibe  
Grater  
Ralador



	Ref	€	h (cm)	U.Venta
A	60305	7,00	23	6 <b>4 caras</b> · 4 faces
B	60307	16,10	24	6 <b>6 caras</b> · 6 faces

## Rallador LUXE

Râpe  
Reibe  
Grater  
Ralador



	Ref	€	h (cm)	U.Venta
A	61354	27,80	23,5	1 <b>4 caras</b> · 4 faces
B	61356	28,00	23,0	1 <b>6 caras</b> · 6 faces

# Colección RALLADORES

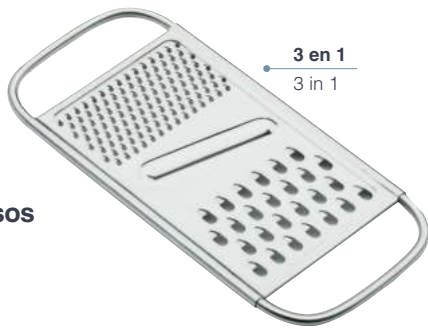

## Rallador plano 3 usos

Râpe plat  
Reibe 3 Nützlichkeit  
Grater 3 uses  
Ralador plano 3 usos

Ref	€	cm	U.Venta
60301	7,60	25,5x11	12



## Rallador plano paso grueso

Râpe plat  
Reibe, grob  
Grater big hole  
Ralador plano passo grosso

Ref	€	cm	U.Venta
60302	7,60	25,5x11	12



## Rallador plano paso fino

Râpe plat  
Reibe, fein  
Grater small hole  
Ralador plano passo fino

Ref	€	cm	U.Venta
60303	7,60	25,5x11	12



Inox  
18/10

## Rallador de limón

Râpe muscade  
Zitronenreibe  
Grater semi-circular  
Ralador de limão

Ref	€	cm	U.Venta
67008	6,00	23x6	12

**Recoge el jugo de las especias sin desperdiciar nada**  
Collection of juice from spices and avoids waste



## Rallador especias mini

Râpe à épices mini  
Mini-Reibe Gewürze  
Mini spices grater  
Ralador especiarías mini

Ref	€	cm	h (cm)	U.Venta
67032	3,60	11x7	1	6

**Extremadamente afilado**  
Extremely sharp

## Rallador nuez moscada mini

Râpe à noix de muscade mini  
Mini-Musket Reibe  
Mini nutmeg grater  
Ralador noz-moscada mini

Ref	€	h (cm)	U.Venta
67009	2,10	14	12



- Superficie de rallado muy afilado.
- Ideal para rallar nuez moscada, ajo, cítricos y chocolate.
- El depósito almacena los alimentos en polvo ya rallados para espolvorearlos con facilidad.
- El compartimento es ideal para guardar las especias enteras.

- Surface de râpage très aiguisée.
- Idéal pour râper la noix de muscade, l'ail, les agrumes et le chocolat.
- Le conteneur stocke les aliments en poudre déjà râpés afin de pouvoir facilement les saupoudrer.
- Le compartiment est idéal pour ranger les épices entières.

- Very sharp grater surface.
- Ideal for grating nutmeg, garlic, citrus fruits and chocolate.
- The container stores the grated ground food so it can be easily sprinkled.
- The compartment is perfect for storing whole spices.



## Rallador nuez moscada

Râpe à muscade  
Musket Reibe  
Nutmeg grater  
Ralador noz-moscada

Ref	€	cm	h (cm)	U.Venta
67031	10,30	4,5x3	15	12

Inox  
18/10

2 cilindros intercambiables: fino · grueso  
2 interchangeable cylinders: fine · coarse

### Rallador inox

Hachoir en inox  
Käsereibe, Rostfrei  
St. steel cheese grater  
Ralador inóx com manivela

Ref	€	cm	U.Venta
60335	34,40	13,5x20x10	1

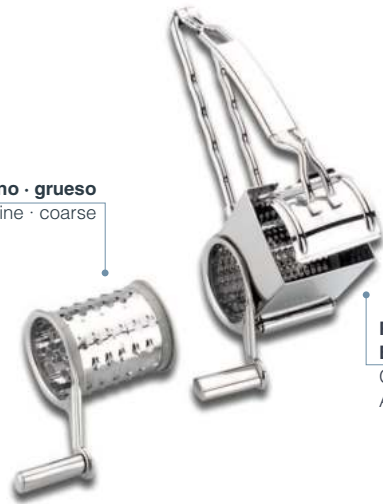

Ralla sin esfuerzo  
Evita cortes  
Grates effortlessly  
Avoid cuts



2 en 1  
2 in 1

### Rallador DUAL

Râpe  
Reibe  
Grater  
Ralador

Ref	€	L (cm)	U.Venta
61360	10,10	31,0	6

4 in 1



### Rallador decorador multiusos

Râpe pour décoration multi-usages  
Mehrzweckreibe zum Verzieren  
Multipurpose zester  
Ralador decorador multiusos

Ref	€	L (cm)	U.Venta
63911	11,30	18,0	1



### Rallador

Râpe  
Reibe  
Grater  
Ralador

	Ref	€	U.Venta	
A	61341	15,60	1	Extra fino · Extra thin
B	61342	15,60	1	Fino · Thin
C	61343	15,60	1	Grueso · Thick
D	61344	15,60	1	Juliana · Julienne



### Rallador largo

Râpe longue  
Reibe, lang  
Lengthways grater  
Ralador comprimo

	Ref	€	U.Venta	
A	61346	15,60	1	Fino · Thin
B	61347	15,60	1	Medio · Medium
C	61348	15,60	1	Grueso · Thick
D	61349	15,60	1	Fino+Medio · Thin+Medium





# Mandolina VERTICAL



**Corte fácil, rápido y seguro**  
Easy, fast and safe cutting

- 5 veces más rápido** · 5 times quicker
- Máxima seguridad** · Maximum security



- Su cuchilla extremadamente afilada proporciona un corte homogéneo y preciso.
- Corte por accionamiento vertical con una palanca de retroceso automatico.
- Procesado de alimentos 5 veces más rápido que el trabajo manual.
- Pie plegable y base con 8 ventosas para mejorar la estabilidad en el uso.
- **SEGURO:** protector contra cortes, no hay contacto directo con las manos durante su uso.
- Dispone de un contenedor que recoge los alimentos cortados.
- Palanca con posición de bloqueo de seguridad, muy seguro para su transporte y almacenaje.
- Fácil limpieza, incluye cepillo.

- Sa lame extrêmement affilée confère une coupe homogène et précise.
- Coupe par actionnement vertical avec un levier à retour automatique.
- Traitement des aliments 5 fois plus rapide que via le travail manuel.
- Pied pliable et base avec 8 ventouses pour améliorer la stabilité lors de l'utilisation.
- ASSURANCE: Protection anti-coupures. Pas de contact direct avec les mains pendant l'utilisation.
- Dispose d'un conteneur qui recueille les aliments coupés.
- Levier avec position de blocage de sécurité, très sûr pour le transport et le rangement.
- Nettoyage facile. Inclut une brosse.

- Scharfe Klängen sorgen für einheitliches und genaues Schneiden.
- Automatischer Rückstellhebel führt Schnitte senkrecht aus.
- Verarbeitet Lebensmittel 5-mal schneller als in Handarbeit.
- Klappbarer Fuß und Sockel mit 8 Saugnäpfen für mehr Stabilität beim Gebrauch.
- VERSICHERUNG: Schützt gegen Schnitte, ohne direkten Handkontakt beim Gebrauch.
- Mit Auffangbehälter für das Schnittgut.
- Hebel mit verriegelter Sicherheitsstellung, für sicheren Transport und Aufbewahrung.
- Einfache Reinigung, Bürste inbegriffen.

- It's extremely sharp blade enables even and precise cutting.
- Vertically operated cutting with an automatic recoil lever.
- Processes food 5 times quicker than manual cutting.
- Foldable legs and base with 8 suckers to improve stability during use.
- SAFE: Anti-cut protector; no direct contact with hands during use.
- Includes a container that collects the chopped food.
- Lever with safety lock position; very safe for transport and storage.
- Easy cleaning; includes brush.

- A sua lâmina afiada proporciona um corte homogéneo e de precisão.
- Corte por acionamento vertical com alavanca de retrocesso automático.
- Processa os alimentos 5 vezes mais rápido do que o trabalho manual.
- Patas dobráveis e base com 8 ventosas para maior estabilidade durante o uso.
- **SEGURO:** Protetor contra cortes, que evita o contacto direto com as mãos durante o corte.
- Recipiente para recolher os alimentos cortados.
- Alavanca com posição de bloqueio de segurança, ideal para o seu transporte e armazenamento.
- Fácil de limpar. Inclui escova de limpeza.



**Se pliega. Bloqueo de seguridad, muy seguro para su transporte y almacenaje**

Fold up. Safety lock position; very safe for transport and storage



**Multifunción: 4 tipos de corte**  
Multifunction: 4 types of cut

**Rodajas lisas (0,5 - 8 mm)**  
Smooth slices (0,5 - 8 mm)

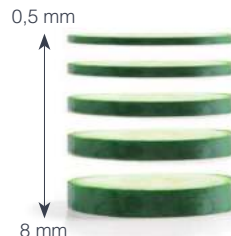

**Cubos**  
Máx: 8 x 8 mm / Mín.: 0,5 x 4 mm  
Cubes  
Max: 8 x 8 mm / Min.: 0,5 x 4 mm



**Juliana (8 mm)**  
Julienne (8 mm)



**Juliana (4 mm)**  
Julienne (4 mm)



## Mandolina vertical

Mandoline verticale  
Mandoline, Vertikale  
Vertical mandoline  
Mandolina vertical

Ref	€	Corte rodaja	Corte juliana	Corte cubos	U.Venta
60460	40,20	0,5 - 8 mm	4 - 8 mm	8x8 mm (max) / 0,5x4 mm (min)	1

# Colección MANDOLINAS

Inox



## Mandolina MULTI

Mandoline  
Mandoline  
Mandoline  
Mandolina

Ref	€	cm	U.Venta
60331	30,90	14,5x34,5	1



- Gira la rueda para seleccionar el espesor de corte o el tipo de juliana que desees obtener.
- Sus cuchillas extremadamente afiladas proporcionan un corte homogéneo y preciso.
- Base antideslizante y protector de dedos que evita el contacto con las cuchillas durante su uso.
- Las cuchillas se extraen fácilmente para su lavado.
- Pies plegables con base de silicona para mejorar la estabilidad.

- Faites tourner la roue pour sélectionner l'épaisseur de la coupe ou le type de julienne que vous souhaitez obtenir.
- Ses lames extrêmement aiguisées confèrent une coupe homogène et précise.
- Base antidérapante et protection pour les doigts qui évite le contact avec les lames pendant son utilisation.
- Les lames se retirent facilement pour leur nettoyage.
- Pieds réglables avec base en silicone pour améliorer la stabilité.

- Schnittstärke oder Juliennart nach Wunsch am Drehknopf einstellbar.
- Extrem scharfe Klingen sorgen für einheitliches und genaues Schneiden.
- Rutschfeste Standbeine und Fingerschutz verhindern Kontakt mit Klingen bei Gebrauch.
- Zum säubern leicht entnehmbare Klingen.
- Einklappbare Standbeine mit Silikonuntersatz für verbesserte Standfestigkeit.

- Turn the wheel to select the thickness of the slice or the type of julienne cut you wish to make.
- Its extremely sharp blades make even and accurate cuts.
- Non-slip base and finger guard to prevent coming in contact with the blades during usage.
- The blades can be easily removed for washing.
- Folding legs with a silicone base to improve stability.

- Gire a roda para seleccionar a espessura de corte ou o tipo de juliana pretendido.
- As suas lâminas extremamente afiadas proporcionam um corte homogéneo e preciso.
- Base antideslizante e protetor de dedos, que evita o contacto com as lâminas durante o uso.
- As lâminas extraem-se facilmente para a sua lavagem.
- Patas dobráveis, com base de silicone para maior estabilidade.

## Mandolina corte en V + 5 cuchillas + exprimidor

Mandoline avec lames en "V" + 5 lames + presse-fruits  
"V" Mandoline + 5 Messer + Zitruspresse  
"V" Mandoline + 5 blades + squeezer  
Mandolina "V" + 5 lâminas + espremedor

Ref	€	cm	U.Venta
60356	38,00	13x33,5	1



## Mandolina inox con 5 cuchillas LUXE

Mandoline en inox avec 5 lames  
Mandoline, Rostfrei, mit 5 Messer  
St. Steel mandoline with 5 blades  
Mandolina inóx com 5 lâminas

Ref	€	cm	U.Venta
60332	117,10	14x42	1



Cuchillas giratorias  
Rotating blades

## Mandolina inox con protector

Mandoline en inoxydable avec protecteur  
Mandoline, Edelstahl, mit Restehalter  
St. steel mandoline slicer w/protector  
Mandolina inoxidável com protector

Ref	€	cm	U.Venta
60357	126,80	12,5x50	1

# Colección MÁQUINAS DE CORTE



· **Aumenta la productividad disminuyendo el tiempo de trabajo frente a sistemas convencionales.**

Gama de corte profesional con 4 modelos de corte manual. Con un diseño robusto y ergonómico, gracias a sus cuchillas de acero inoxidable (resistentes a la corrosión), aseguran un corte uniforme y de gran calidad. Ideales para cualquier cocina Industrial, su fácil manejo permite obtener un óptimo rendimiento con el mínimo esfuerzo.

· **Augmente la productivité et diminue le temps de travail par rapport aux systèmes conventionnels.**

Gamme de coupe professionnelle avec 4 modèles de coupe manuelle. Avec une conception robuste et ergonomique, notamment grâce aux lames en acier inoxydable (résistantes à la corrosion), ils garantissent une coupe uniforme et de grande qualité. Ils s'adaptent parfaitement aux différents types de cuisine industrielle et la facilité de manipulation permet d'obtenir un rendement optimal avec le moindre effort.

· **Erhöht im Vergleich zu konventionellen Systemen die Produktivität bei geringerer Arbeitszeit.**

Profi-Allesschneidern mit 4 Modelle im Bereich Handschneidemaschinen. Robustes und ergonomisches Design; seine Edelstahlklingen (rostresistent) garantieren einen gleichmäßigen, präzisen Schnitt. Ideal für jede Industrieküche, da die einfache Bedienung optimale Leistung bei minimalem Aufwand erlaubt.

· **Increases productivity by reducing working time when compared to conventional systems.**

Range of professional cutting Utensils with 4 new manual cutting models. With a robust and ergonomic design, its stainless steel (corrosion resistant) blades ensure a smooth and high quality cut. Ideal for any Industrial kitchen, their ease of use enables optimum performance with minimum effort.

· **Aumenta a produtividade reduzindo o tempo de trabalho em comparação com os sistemas convencionais.**

Gama de corte profissional com 4 novos modelos de corte manual. Com um design robusto e ergonómico, graças às suas lâminas de aço inoxidável (resistentes à corrosão), asseguram um corte uniforme e de grande qualidade. Ideais para qualquer cozinha industrial, o seu fácil manejo permite obter um ótimo rendimento com o mínimo esforço.

**10 cuchillas de corte**  
10 cutting blades



- **Asa de gran robustez para transportar la máquina.**
- **10 cuchillas para un perfecto laminado.**
- **Bandeja recogelimentos.**
- **Ventosas de sujeción.**

- Anse extrêmement robuste pour transporter la machine.
- 10 lames pour une plastification parfaite.
- Plateau destiné au ramassage des aliments.
- Préhension ventouses.

- Extrem robuster Tragegriff.
- 10 Klingen für eine perfekt Schnittstärke.
- Servierplatte.
- Greif Saugnäpfe.

- Robust handle for carrying the machine.
- 10 blades for a perfect lamination.
- Food collection tray.
- Gripping suckers.

- Asa de grande robustez para transportar a máquina
- 10 lâminas para uma laminação perfeita.
- Bandeja recolhadora de alimentos.
- Ventosas de sujeção.

## Máquina corta tomates

Machine pour couper tomates  
Tomatenschneider  
Tomato cutter machine  
Máquina cortador tomate

Ref	€	Espesor (mm) / Nº rodajas	cm	Kg	U.Venta
60510	248,00	5,5 / 9 rodajas	43x20x21	5,20	1



**2 en 1**  
2 in 1



- **Colóquelo donde quiera (mesa-pared-tabla).**
- **4 cuchillas diferentes:**  
**7x7 mm / 10x10 mm / 15x15 mm / 8 gajos.**
- **Estructura desmontable y fácil limpieza.**

- Placer où (table-mur-table).
- 4 lames différentes :  
7x7 mm / 10x10 mm / 15x15 mm / 8 coins.
- Structure démontable et facile à nettoyer.

- Placieren Sie sie ob immer (Tisch-Wand-Brett).
- 4 verschiedenen Klingen:  
7x7 mm / 10x10 mm / 15x15 mm / 8 Scheiben.
- Leicht zu reinigende auseinandermontierbare Struktur.

- Place it wherever (table-wall-board).
- 4 different blades:  
7x7 mm / 10x10 mm / 15x15 mm / 8 wedges.
- Collapsible structure and easy cleaning.

- Coloque-o onde quer (tabela- parede-tabela).
- 4 lâminas diferentes:  
7x7 mm / 10x10 mm / 15x15 mm / 8 cunhas.
- Estrutura desmontável e de fácil limpeza.

**AL**

Aluminium

## Máquina corta patatas y gajos

Machine pour chips trancheuse et wedger  
Pommes Frites und Wedger-Schneider  
Potato chips slicer and wedger machine  
Máquina cortador batatas e gomos

Ref	€	Dados (mm)	Gajos	cm	Kg	U.Venta
60513	223,40	7x7 / 10x10 / 15x15	8	26x26x42	8,0	1



**Soporte de sujeción a la superficie de trabajo**  
Work surface support bracket

**3 cuchillas de corte**  
3 cutting blades



- Colóquelo donde quiera (mesa-encimera-tabla).
- 3 cuchillas diferentes; 6x6 mm / 8x8 mm / 10x10 mm.
- Estructura desmontable y fácil limpieza.

- Placer où (table-worktop-table).
- 3 lames différentes; 6x6 mm / 8x8 mm / 10x10 mm.
- Structure démontable et facile à nettoyer.

- Placieren Sie sie ob immer (Tisch-Wand-Brett).
- 3 verschiedenen Klingen; 6x6 mm / 8x8 mm / 10x10 mm.
- Leicht zu reinigende auseinandermontierbare Struktur.

- Place it wherever (table-worktop-board).
- 3 different blades; 6x6 mm / 8x8 mm / 10x10 mm.
- Collapsible structure and easy cleaning.

- Coloque-o onde quer (tabela- bancada-tabela).
- 3 lâminas diferentes; 6x6 mm / 8x8 mm / 10x10 mm.
- Estrutura desmontável e de fácil limpeza.

## Corta patatas chip 3 cortadores

Coupe-Frites 3 Lames  
Pommes Frites-Schneider, 3 Klingen  
Potato Chips Cutter 3 Blades  
Corta-batatas chip 3 cortadores

Ref.	€	Dados (mm)	U.Venta
60343	210,50	6x6 / 8x8 / 10x10	1

**AL**

Aluminium

## Máquina corta patatas vertical

Machine pour chips trancheuse vertical  
Pommes Frites-Schneider vertikal  
Vertical chips slicer machine  
Máquina cortador batatas vertical



- Amortiguadores para evitar golpes al cortar los alimentos.
- Asa empujador robusta para un mejor manejo.
- Patas de goma para una mejor sujeción.

- Amortisseurs pour éviter les coups pendant la coupe des aliments.
- Poignée pousseeur robuste pour une meilleure manipulation.
- Pieds en caoutchouc pour une saisie optimale.

- Stoßdämpfer für geschmeidigeres Schneiden.
- Robuster Restehalter für einfache Bedienung.
- Antirutsch-Gummifüße.

- Shock absorbers to prevent any knocks when cutting food.
- Robust pusher handle for better handling.
- Rubber feet for better grip.

- Amortecedores para evitar golpes ao cortar os alimentos.
- Asa de empurrar robusto para um melhor manejo.
- Patas de borracha para melhor sujeição.

Ref	€	Dados (mm)	cm	h (cm)	Kg	U.Venta
60511	176,90	10x10	20x20	48	6,0	1

# Taco de corte **CARNICERO**

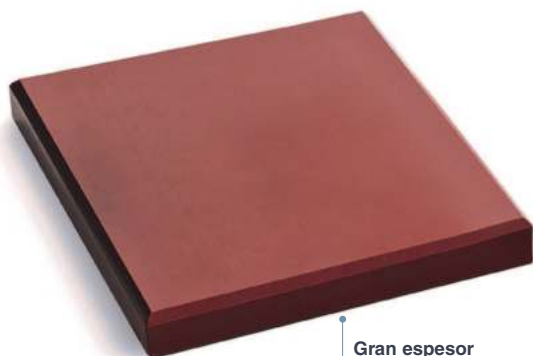

**Gran espesor**  
Great thickness

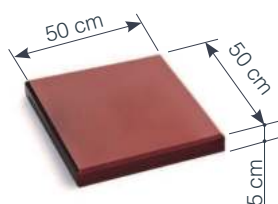

## Tajo de corte carnicero

Planche à découper la viande  
Metzger-Schneidblock  
Butcher Block  
Cepo de corte de carnicero

**Ideal para cocinas profesionales, carnicerías, pescaderías, etc.**

Perfect for professional kitchens, butcher shops or fishmongers, etc.

- Fabricada en polietileno de alta densidad. Espesor de 5 mm.
- Su dureza le confiere una mayor resistencia a la abrasión, durabilidad y una gran absorción de los golpes.
- Material no poroso que facilita su limpieza. No acumula olores ni sabores.
- Apta para lavavajillas.
- Cumple con todas las garantías sanitarias para la manipulación de alimentos exigidas por la unión europea.

- Fabriquée en polyéthylène de haute densité. Épaisseur de 5 mm.
- Sa dureté lui confère une plus grande résistance à l'abrasion, et une durabilité et une absorption des chocs accrues.
- Matériau non poreux qui facilite son nettoyage. Ne garde ni les odeurs ni les goûts.
- Apte pour le lave-vaisselle.
- Répond à toutes les garanties sanitaires pour la manipulation d'aliments exigées par l'Union Européenne.

- Made of high density polyethylene 5 mm Thick
- Its hardness gives it greater resistance to abrasion, more durability and high impact absorption.
- The non-porous material makes it easy to clean. There is no build-up of odours or flavours.
- Dishwasher safe
- Meets all health guarantee for food handling required by the European Union.

Ref	€	cm	h (cm)	Kg	U.Venta
60578	174,50	50x50	5,0	12	1

# Jamoneros **POLIETILENO**



**Tacos antideslizantes**  
Non slip plugs

## Jamonero

Support pour jambon  
Schinkenhalter  
Ham-support  
Suporte presunto

Ref	€	cm	h (cm)	U.Venta
62344	91,90	50x20,5	35,5	1



**Plegable**  
Folding

## Jamonero abatible

Support pour jambon rabattable  
Schinkenhalter, Verstellbar  
Folden ham-support  
Suporte presunto abatible

**Tacos antideslizantes**  
Non slip plugs

Ref	€	cm	h (cm)	U.Venta
62359	90,30	43x19	5	1

# Guantes · Delantal de **PROTECCIÓN**

**Composición / Composition:**  
62% Polietileno / 62% Polyethylene  
24% Poliéster / 24% Polyester  
14% Fibra de vidrio / 14% Glass fiber

**2**

Unid.



- **Ambidiestro, cómodos y ligeros.**
- **NO emplear con sierras giratorias o dentadas.**
- Ambidextres, pratiques et légers.
- NE PAS utiliser avec des scies giratoires ou dentées.
- Beidhändig verwendbar, bequem und leicht.
- NICHT mit Kreissägen oder gezahnten Sägen verwenden.
- Ambidextrous, comfortable and light.
- Do NOT use with rotating or toothed saws.
- Ambidestro, cómodos e leves.
- NÃO utilizar com serras giratórias ou dentadas.

**Resistencia a la abrasión**  
Abrasion resistance **3**

**Resistencia al corte**  
Blade cut resistance **4**

**Resistencia al PDM**  
PDM resistance **C**

**Resistencia al desgarro**  
Tear resistance **4**



344 XC  
**Certificado CE emitido por CTC FRANCE**

## Guante protección

Gant de protection  
Schutzhandschuh  
Protection glove  
Luva de protecção

Ref	€	Talla	Medida	Perim. mano	L (cm)	U.Venta
61101	19,50	M	8	182 mm	24	1
61102	19,50	L	9	192 mm	25	1
61103	19,50	XL	10	204 mm	26	1

**Guantes certificados según regulación EPI EU 2016/425 módulo B**  
Gloves certified according to regulation EPI EU 2016/425 module B



**Ideal para uso en mandolinas profesionales**

Ideal for use in professional mandolins

**Inox**



- **Guante cinco dedos con correa en la muñeca.**
- **Reversible para mano derecha como izquierda.**
- **Diseño de correa extraíble y protección completa de mano.**
- **Fácil de lavar y desinfectar.**
- Gant cinq doigts avec courroie au poignet.
- Réversible pour main droite ou gauche.
- Conception de courroie extractible et protection complète de la main.
- Facile à laver et désinfecter.
- Five-finger glove with strap on the wrist.
- Reversible for both right and left hand.
- Detachable strap and complete hand protection design.
- Easy to wash and disinfect.



**CE Directive 89/686/EEC and EN 1082-1-1996**

## Guante cota

Gant en maille  
Netz-Handschuh  
Chainman glove  
Luva de malha

Ref	€	Talla	Medidas	Perim. mano	Color	U.Venta
39169	139,10	S	7	171 mm	Blanco · White	1
39170	139,10	M	8	182 mm	Rojo · Red	1
39171	139,10	L	9	192 mm	Azul · Blue	1
39172	139,10	XL	10	204 mm	Naranja · Orange	1

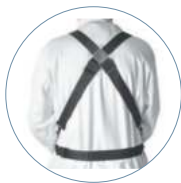

- **Ajustable gracias a sus tirantes verticales y horizontales.**
- **Conviene asegurarse de que las medidas del cuchillo empleado no sean inferiores a:**
- Ajustable grâce à ses bandes verticales et horizontales.
- Il convient de s'assurer que les dimensions du couteau utilisé ne sont pas inférieures à :
- Anpassbar, dank seiner vertikalen und horizontalen Feststellvorrichtung.
- Sie sollten sich vergewissern, dass die Größen der verwendeten Messer nicht kleiner sind als:
- Adjustable thanks to its vertical and horizontal straps.
- Care must be taken to ensure that the knife used does not measure less than:
- Ajustável graças aos seus tirantes verticais e horizontais.
- É conveniente certificar-se de as dimensões da faca utilizada não serem menores de:

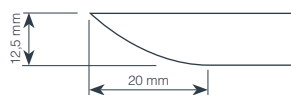

**EN ISO 13998: 2003**  
**NIVEL / LEVEL: 2**

## Delantal cota de malla

Tablier en maille  
Kettenhemb Schürze  
Metal butcher's apron  
Avental de malha

Ref	€	cm	Perimetro	U.Venta
39165	322,40	80x55	95-145 cm	1

# Colección cuchillos **CLASSIC**

**54-58** MOLYBDÄNSTAHL Cucchillo forjado   
 HRc X 45 Cr Mo V 15 Forged knives  
**Acero inoxidable al cromo-molibdeno-vanadio**  
 Chrome-molybdenum-vanadium stainless steel



## Cuchillo CHEF

Couteau de chef  
 Messer Chef  
 Cook's knife  
 Faca Chef

Ref	€	cm	U.Venta
39016	20,10	16	1
39021	24,80	21	1
39025	28,20	25	1
39030	36,20	30	1



## Cuchillo cocina

Couteau de cuisine  
 Küchenmesser  
 Kitchen knife  
 Faca cozinha

Ref	€	cm	U.Venta
39110	10,30	10	1
39112	11,70	12	1
39114	13,20	14	1
39116	16,00	16	1
39118	17,90	18	1
39121	18,70	21	1
39125	20,10	25	1



## Cuchillo pescado / fileteador

Couteau filet-de-sole  
 Filiermesser  
 Filleting/fish knife  
 Faca peixe / filetes

Ref	€	cm	U.Venta
39115	13,20	20	1



## Cuchillo deshuesador

Couteau à désosser  
 Ausbeinmesser  
 Boning knife  
 Faca desossador

Ref	€	cm	U.Venta
39014	16,00	14	1



## Cuchillo patatero

Couteau office  
 Gemüsemesser  
 Paring knife  
 Faca batatas

Ref	€	cm	U.Venta
39185	10,90	8,50	1



## Cuchillo fiambre / pastel

Couteau pour charcuterie  
 Wurst-/Gyrosmesser  
 Salame slicer  
 Faca fiambre / doce

Ref	€	cm	U.Venta
39023	18,80	21	1



## Cuchillo jamonero

Couteau à jambon  
 Schinkenmesser  
 Ham knife  
 Faca de presunto

Ref	€	cm	U.Venta
39020	20,80	21	1
39024	23,40	26	1



## Cuchillo pan

Couteau à pain  
 Brotmesser  
 Bread knife  
 Faca de pão

Ref	€	cm	U.Venta
39027	18,80	21	1



### Cuchillo congelados

Couteau aliments surgelés  
Gefrierwarenmesser  
Frozen food knife  
Faca congelados

Ref	€	cm	U.Venta
39028	19,60	21	1



### Tenedor de trinchar

Fourchette de chef  
Tranchiergabel  
Cook's fork  
Garfo de trinchar

Ref	€	cm	U.Venta
39017	16,70	18	1



### Chaira

Fusil à affûter  
Wetzstahl  
Sharpening steel  
Fusil

Ref	€	cm	U.Venta
39010	21,00	21	1



### Machete

Couperet  
Hackfleischmesser  
Cleaver  
Cutelo

Ref	€	cm	U.Venta
39015	57,40	16	1



### Macheta

Couperet  
Hackfleischmesser  
Cleaver  
Cutelo

Ref	€	cm	U.Venta
39018	21,30	17x8	1



new

### Macheta para pescado

Couperet à poisson  
Sehr Scharfes fischmesser  
Fish cleaver  
Cutelo para peixe

Ref	€	mm	U.Venta
39029	22,00	290	1

### Taco 6 / 8 piezas

6 pcs bloc  
Messerhalter Set, 6-tlg  
6 pc bloc  
Taco 6 peças

Ref	€	Piezas	U.Venta
39000	131,50	6	1
39001	160,90	8	1



#### COMPOSICIÓN (6 pcs.):

- \* Cuchillo Chef 21 cm (39021)
- \* Cuchillo de cocina de 10 cm (39110)
- \* Cuchillo de cocina de 16 cm (39116)
- \* Cuchillo deshuesador 14 cm (39014)
- \* Cuchillo jamonero 20 cm (39020)
- \* Chaira (39010)

#### COMPOSICIÓN (8 pcs.):

- \* Cuchillo Chef 21 cm (39021)
- \* Cuchillo de cocina de 10 cm (39110)
- \* Cuchillo de cocina de 16 cm (39116)
- \* Cuchillo deshuesador 14 cm (39014)
- \* Cuchillo jamonero 20 cm (39020)
- \* Cuchillo pan (39027)
- \* Tenedor trinchar (39017)
- \* Chaira (39010)

- Fabricada en acero inoxidable, con una dureza de HRC56+/-2 (composición: 5Cr15MoV).
- Mango de ABS con remaches en acero inoxidable anticorrosión.
- Ideal para uso doméstico como profesional.
- Muy útil para cortar alimentos duros, así como huesos, nervios, cartílagos, etc.
- Ideal para el corte y manipulación de pescado (39029).
- El equilibrio y balance de pesos de la macheta favorece el corte.

- Fabriqué en acier inoxydable, avec une durabilité de HRC56 +/- 2 (Composition: 5Cr15MoV).
- Manche en ABS avec des rivets en acier inoxydable anti-corrosion.
- Idéal aussi bien pour un usage domestique que professionnel.
- Très utile pour couper les aliments durs, ainsi que les os, les nerfs, le cartilage, etc.
- Idéal pour couper et manipuler le poisson (39029).
- L'équilibre et poids du coutelas favorise la coupe.

- Aus Edelstahl, mit Spitze, Härtegrad HRC56+/-2 (Legierung: 5Cr15MoV).
- ABS-Schaft mit Nieten aus korrosionsbeständigem Edelstahl.
- Ideal für den privaten und professionellen Gebrauch.
- Praktisch zum Schneiden harter Stücke wie Gräten, Knochen usw.
- Ideal zum Schneiden und Verarbeiten von Fisch (36029).
- Gewichtsabstimmung und -verteilung erleichtert den Schnitt.

- Made from stainless steel, with a hardness of HRC56+/- 2 (Composition: 5Cr15MoV).
- ABS handle with anti-rust rivets.
- Perfect for use in the home and by professionals.
- Very useful for cutting hard food, as well as bones, nerves, cartilage, etc.
- Perfect for cutting and handling fish.
- The equilibrium and weight of the cutlass favors the cut.

- Fabricado em aço inoxidável com lâmina pontiaguda, com uma dureza de HRC56+/-2 (Composição: 5Cr15MoV).
- Cabo em ABS com rebites de aço inoxidável anticorrosão.
- Ideal para uso doméstico e profissional.
- Ideal para cortar e manipular peixes.
- Muito útil para cortar alimentos duros e espinhas, ossos, etc.
- O equilíbrio e a distribuição do peso do cutelo facilitam um corte perfeito.



## Maleta 9 piezas

9 pcs mallete de chef  
Messertasche, 9-tlg  
9 pc cook's case  
Mala 9 peças

### COMPOSICIÓN:

- \* Cuchillo de cocina de 10 cm (39110)
- \* Cuchillo de cocina de 18 cm (39118)
- \* Cuchillo de cocina de 25 cm (39125)
- \* Cuchillo deshuesador 14 cm (39014)
- \* Cuchillo jamonero 20 cm (39020)
- \* Cuchillo Chef 25 cm (39025)
- \* Tenedor trinchar (39017)
- \* Macheta (39015)
- \* Chaira (39010)



Ref	€	U.Venta
39004	347,60	1

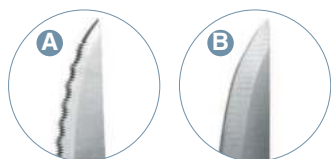

## Set 6 cuchillos chuleteros

6 couteau steak,  
6 steakmesser,  
6 pcs steak knives  
Conjunto 6 facas carne



	Ref	€	L (cm)	U.Venta
A	39060	15,40	21	12
B	39061	14,70	21	12

## Taco 5 cuchillos

5 couteau de Chef Bloc  
5 Messer Chef Set  
5 Chef knife block  
Taco 5 facas Chef



Ref	€	U.Venta
39064	65,00	1

No se desafil  
Does not dull

Evita que las verduras u hortalizas se oxiden  
Prevents vegetables and greens from browning



## Cuchillo cortaverduras

Couteau pour coupe légumes  
Gemüsemesser  
Vegetables knife  
Faca corta verduras

Ref	€	L (cm)	U.Venta
60386	1,90	18	24



Inox  
18/10



Inox  
18/10

## 6 ganchos carnicero 1 punta

6 crochets de boucher 1 conseil  
6-Tlg Metzgerhaken, 1 spitze  
6 butchers hook 1 point  
6 ganchos de carnicero 1 ponta

	Ref	€	Ø (mm)	L (cm)	U.Venta
A	39043	11,70	5	12,5	4
B	39044	18,10	5	18,5	1

## 6 ganchos carnicero 2 puntas

6 crochets de boucher 2 conseils  
6-Tlg Metzgerhaken, 2 spitzes  
6 butchers hook 2 points  
6 ganchos de carnicero 2 pontas

	Ref	€	Ø (mm)	L (cm)	U.Venta
A	39047	11,80	5	12,5	4
B	39048	18,30	5	18,5	1

# Bloque magnético con cuchillos **MAGNET**

new



- Set de 5 cuchillos y bloque de madera de haya 100% natural con un potente imán integrado.
- Cuchillos de acero inoxidable con hojas totalmente afiladas y resistentes al desgaste.
- Mango ergonómico y antideslizante para un agarre firme y cómodo. Acabado Soft Touch.
- Diseño 100% estable: bloque firme y sólido.
- Superficie de sujeción: 21x22,5 cm.
- Ideal para mantener en buen estado los filos de los cuchillos y tenerlos siempre a mano.
- Composición: cuchillo Chef, cuchillo fileteador, cuchillo pan, cuchillo multiusos, cuchillo pelador y bloque magnético.

- Ensemble de 5 couteaux et support en hêtre 100% naturel avec un puissant aimant intégré.
- Couteaux en acier inoxydable avec fils entièrement aiguisés et résistants à l'usure.
- Manche ergonomique et antidérapant pour une prise en main ferme et pratique. Finition Soft Touch.
- Conception 100% stable : bloc fixe et solide.
- Surface d'adhésion : 21 x 22,5 cm.
- Idéal pour conserver en bon état les fils des couteaux et les avoir toujours à portée de main.
- Composition : Couteau de Chef, couteau à découper, couteau à pain, couteau multi-usages, couteau éplucheur et bloc magnétique.

- 5-Teiliges Messer-Set samt Block aus 100 % natürlichem Buchenholz mit starkem Magnet.
- Messer aus Edelstahl mit super-scharfen und verschleißbeständigen Klingen.
- Ergonomischer und rutschfester Griff für einen festen und bequemen Halt. Soft Touch-Griff.
- 100 % standfestes Design: solider und stabiler Block.
- Hält Messer stets scharf und griffbereit.
- Standfläche: 21 x 22,5 cm.
- Set bestehend aus: Kochmesser, Filetmesser, Brotmesser, Mehrzweck-Messer, Schälmesser und magnetischer Block.

- Set of 5 knives and a 100% natural beech wood block with a powerful built-in magnet
- The knives are stainless steel and the blades are completely sharpened and resistant to wear.
- They have ergonomic, non-slip handles for a firm yet comfortable grip and a Soft Touch finish.
- 100% Stable Design: the block is solid and sturdy.
- Attachment area: 21 x 22.5 cm.
- It's perfect for having the knives always handy and keeping their blades in good condition.
- Contents: Cook's knife, filleting knife, bread knife, multipurpose knife, peeler knife and magnetic block.

- Conjunto de 5 facas e bloco de madeira de faia 100% natural, com um potente ímã integrado.
- Facas em aço inoxidável, com lâminas afiadas e resistentes ao desgaste.
- Mango ergonómico e antideslizante para uma sujeição firme e cómoda. Acabamento Soft Touch.
- Desenho 100% estável: bloco firme e sólido.
- Superfície de sujeição: 21x22,5 cm.
- Ideal para manter em bom estado o fio das lâminas e ter as facas sempre à mão.
- Composição: Faca de chef, faca de filetar, faca para pão, faca multiusos, faca para descascar e bloco magnético.

**Mango ergonómico.**  
**Acabado SOFT TOUCH**  
Ergonomic handle.  
SOFT-TOUCH finish

**Madera de haya 100% natural.**  
**Potente imán integrado**  
100% Natural beech Wood.  
Built-in powerful magnet





## Bloque magnético con cuchillos **MAGNET**

Bloc magnétique avec couteaux  
Magnetblock mit Messern  
Magnetic block with knives  
Bloco magnético com facas

	Ref	€	L (cm)	U.Venta	
<b>A</b>	39031	72,90	-	1	Bloque magnético con cuchillos
<b>B</b>	39032	9,00	20,0	1	Cuchillo Chef
<b>C</b>	39034	8,70	20,0	1	Cuchillo pan
<b>D</b>	39033	8,70	20,5	1	Cuchillo fileteador
<b>E</b>	39035	6,60	12,5	1	Cuhillo multiusos
<b>F</b>	39036	6,50	10,0	1	Cuchillo pelador

# Colección cuchillos PROFESIONAL

54-58 MOLYBDÄNSTAHL Mango Antideslizante   
 HRC X 45 Cr Mo V 15 Non-slip long handle knives 

Acero inoxidable al cromo-molibdeno-vanadio  
 Chrome-molybdenum-vanadium stainless steel



## Cuchillo CHEF

Couteau de chef  
 Messer Chef  
 Cook's knife  
 Faca Chef

Ref	€	cm	U.Venta
49016	6,90	16	12
49021	10,20	21	12
49025	12,00	25	12
49030	13,00	30	12



## Cuchillo cocina

Couteau de cuisine  
 Küchenmesser  
 Kitchen knife  
 Faca cozinha

Ref	€	cm	U.Venta
49110	4,80	10	12
49112	4,80	12	12
49116	5,60	16	12
49121	7,20	21	12



## Cuchillo patatero

Couteau office  
 Gemüsemesser  
 Paring knife  
 Faca batatas

Ref	€	cm	U.Venta
49185	4,30	8,50	12



## Cuchillo jamonero

Couteau à jambon  
 Schinkenmesser  
 Ham knife  
 Faca de presunto

Ref	€	cm	U.Venta
49024	8,20	26	12



## Cuchillo deshuesador

Couteau à désosser  
 Ausbeinmesser  
 Boning knife  
 Faca desossador

Ref	€	cm	U.Venta
49014	5,30	14	12



## Cuchillo pan

Couteau à pain  
 Brotmesser  
 Bread knife  
 Faca de pão

Ref	€	cm	U.Venta
49027	7,40	21	12



## Tenedor de trinchar

Fourchette de chef  
 Tranchiergabel  
 Cook's fork  
 Garfo de trinchar

Ref	€	cm	U.Venta
49017	6,40	18	12



## Cuchillo Santoku

Couteau Santoku  
 Messer Santoku  
 Santoku knife  
 Faca Santoku

Ref	€	cm	U.Venta
49210	6,40	10	12
49212	7,80	12	12
49216	10,70	16	12

# Colección cuchillos **CERAMIC**

<b>CZ</b>	<b>87</b>	Mango Antideslizante	
Zirconia	HRc	Non-slip long handle knives	Dishwasher

- Mango ergonómico antideslizante, con un diseño moderno e innovador.
- Resistentes, ligeros e higiénicos.
- **NO oxida los alimentos.**
- El filo se mantiene hasta diez veces más que los cuchillos convencionales.

- Manche ergonomique antidérapant, le tout avec un design moderne et novateur.
- Résistants, légers et hygiène.
- NO oxyde alimentaire.
- Le tranchant reste aiguisé jusqu'à dix fois plus longtemps que les couteaux conventionnels.

- Ergonomische und rutschfeste Griffe, modernes und innovatives Design.
- Widerstandsfähig, leicht und hygienisch.
- Oxidiert keine Lebensmittel.
- Die Schneide bleibt bis zu zehnmal länger scharf als bei herkömmlichen Messern.

- Ergonomic non-slip handles, modern and innovative design.
- Resistant, light and hygiene.
- NO oxidizes food.
- The edge remains sharp up to ten times longer with conventional knives.

- Cabo ergonómico antideslizante, com um desenho moderno e inovador.
- Resistentes, leves e higiene.
- NÃO oxida os alimentos.
- A aresta permanece afiada até dez vezes mais com facas convencionais.

**Apto para cuchillos cerámicos e inoxidables**

Suitable for knives ceramic and stainless



## Chaira **DIAMANTE**

Fusil à affûter **DIAMANT**  
Wetzstahl, **DIAMANT**  
DIAMOND sharpening steel  
Fusil **DIAMANTE**

Ref	€	cm	U.Venta
39075	35,60	21	1



## Cuchillo cocina

Couteau de cuisine  
Küchenmesser  
Kitchen knife  
Faca cozinha

	Ref	€	cm	U.Venta
<b>A</b>	39208	10,70	8	1
<b>B</b>	39210	11,70	10	1
<b>C</b>	39212	19,80	12	1
<b>D</b>	39215	25,70	15	1
<b>E</b>	39218	38,10	18	1
<b>F</b>	39213	23,80	12	1



**Con funda protectora**  
With protective sheath

# Colección TIJERAS

Inox



new

## Tijeras de cocina AVES

Ciseaux pour volaille AVES  
Geflügelschere, AVES  
AVES poultry shears  
Tesouras de cozinha AVES



Ref	€	cm	U.Venta
60001	18,80	7,5x27	12



Tijeras  
Scissors



Desescamador  
Scraper

## Tijera-desescamador desmontable

Ciseaux ecailleur amovible  
Auseinandernehmbare Schere-Fischentschupper  
Dismountable scissors-scraper  
Tesoura-raspador removível



Ref	€	L (cm)	U.Venta
60061	5,90	23,00	1



Protector y cepillo de limpieza  
Protector and cleaning brush

## Tijeras 5 cortes + peine de limpieza

Ciseaux 5 coupe + peigne pour nettoyage  
5-fach Schneideschere + Reinigungs Kamm  
5 Cuts vegetable scissor+cleaning comb  
Tesouras 5 cortes + pente de limpeza

Ref	€	cm	U.Venta
60022	8,50	27x13x3	6

- 1.- Tijeras · Scissors
- 2.- Abrebotellas · Unscrew
- 3.- Cascanueces · Nut cracker

50-54

HRc

## Tijeras profesional inox

Ciseaux professionnel en inox  
Geflügelschere Professionel  
St. Steel professional scissors  
Tesouras professional inóx

Ref	€	cm	U.Venta
38010	21,80	7,0x20	12



3 en 1  
3 in 1

Hojas microdentadas curvadas,  
extremadamente afiladas y duraderas  
Micro-serrated curved blades that are  
extremely sharp and long-lasting

Ergonómico y agarre  
antideslizante  
Ergonomic and non-slip  
grip

Ambidiestro  
Ambidextrous



FO  
Forjado  
Wought

## Tijeras para aves INOX

Ciseaux à volaille  
Geflügelschere  
Poultry shears  
Tesouras para aves

Ref	€	L (cm)	U.Venta
60066	35,20	25	1



Sistema de cierre de  
seguridad  
Safety closure system



Soporte magnético  
Magnetic holder

## Tijeras cocina con funda

Ciseaux pour cuisine avec housse  
Küchenschere mit Überzug  
Kitchen scissor with sheath  
Tesouras de cozinha com capa

Ref	€	L (cm)	U.Venta
60059	10,00	21,5	6



## Tijeras de cocina

Ciseaux pour cuisine  
Küchenschere  
Kitchen shears  
Tesouras de cozinha

Ref	€	cm	U.Venta
60018	10,70	8,5x21	1
60023	10,80	8,5x24	1



# Soportes **MAGNÉTICOS**



- Potente imán en el interior para sujetar con seguridad los cuchillos, tijeras y otros artículos metálicos.
- Incluyen un set de montaje para instalar el soporte de cuchillos sobre cualquier tipo de pared.

- Puissant aimant à l'intérieur pour tenir en toute sécurité les couteaux, les ciseaux et tout autre ustensile métallique.
- Inclut un set de montage pour installer le support à couteaux sur tout type de mur.

- Starker Magnetkern – hält Messer, Scheren und andere Gegenstände aus Metall sicher und fest.
- Inkl. Montagesatz zum Anbringen des Messerhalters an jeder Art von Wand.

- It has a powerful magnet inside for safely holding knives, scissors or other metal items.
- Installation hardware for mounting the support on any kind of wall is included.

- O seu potente imã interior permite sujeitar com segurança as facas, tesouras e outros utensílios metálicos.
- Inclui um kit de montagem para instalar o suporte para facas em qualquer tipo de parede.

## Soporte magnético cuchillos

Support magnétique pour couteaux  
Magnethalterung für Messer  
Magnet support for knives  
Suporte magnético de facas

Ref	€	Total (cm)	Útil (cm)	U.Venta
39008	8,90	38	35,0	12
39009	10,80	55	52,3	12

Potente imán  
Powerful magnet

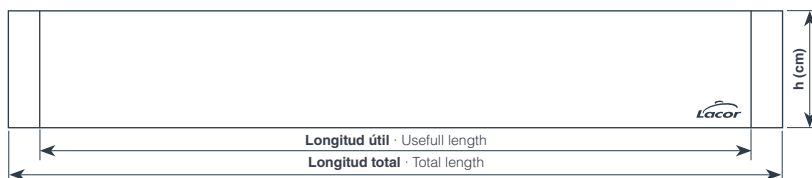
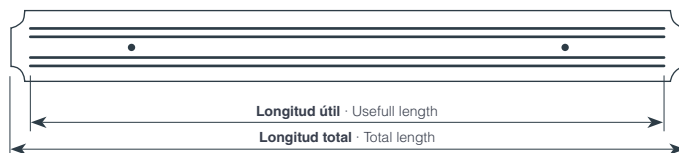

Potente imán  
Powerful magnet

## Madera caucho

Rubber Wood

Madera de caucho  
Rubber Wood



## Soporte magnético cuchillos

Support magnétique pour couteaux  
Magnethalterung für Messer  
Magnet support for knives  
Suporte magnético de facas

Ref	€	Total (cm)	h (cm)	Útil (cm)	U.Venta
39108	27,10	36	6	33	1
39109	31,70	45	6	42	1



Parte trasera del soporte · Back of the support

# Afiladores · Abrelatas MANUALES



## Orientación de afilado

Sharpening orientation



- Afila cuchillos de filo liso.
- 2 zonas de afilado: afilado estándar y afilado alta precisión.
- Cada zona consta de: 2 discos de acero de carburo duro (grueso) para vaciar bordes.  
2 discos de cerámica fina para terminar el borde.
- Fácil de usar, empuje el filo en un ángulo de 90° con una ligera presión.
- Asa con goma y ranuras para los dedos que proporciona un manejo sencillo y seguro.

- Aiguiseur pour lames lisses.
- 2 zones d'affûtage : affûtage standard et affûtage de haute précision
- Chaque zone est composée de : 2 disques en acier au carbone dur (épais) pour restaurer le fil.  
2 disques en céramique fine pour terminer le fil.
- Facile à utiliser : pousser la lame à un angle de 90° avec une légère pression.
- Poignée avec caoutchouc et rainures pour les doigts qui confère une prise en main simple et sûre.
- Sharpen smooth blade knives.
- 2 sharpening zones: standard sharpening and high precision sharpening.
- Each zone consists of: 2 thick carbide steel rods for cleaning up edges.  
2 thin ceramic rods for honing edges.
- Easy to use: push the knife at a 90° angle using light pressure.
- Rubber handle with finger grooves for safe and easy use.



## Afilador de cuchillos DUAL

Affûteuse de couteaux  
Schärfmaschine  
Knives sharpener  
Afiador de facas

Ref	€	cm	U.Venta
39266	18,70	21,5x4,5x9	1

## Base de goma antideslizante, garantiza mayor seguridad

Non-slip rubber base, guarantees better safety

## Afilador de cuchillos WHITE

Affûteuse de couteaux  
Schärfmaschine  
Knife sharpener  
Afiador de facas

Ref	€	U.Venta
39065	9,80	6

## Un mejor agarre

A better grip



## Abrelatas de mesa profesional

Ouvre-boîte de table professionnel  
Profe-Dosenöffner für Tisch  
Professional table tin opener  
Abre-latas de mesa profesional

Ref.	€	U.Venta
63005	128,20	1 Negro (Black)
63015	189,00	1 Inox

Altura máx. de lata: 30 cm  
Maxime height of caniste: 30 cm



## Abrelatas

Ouvre-boîte  
Dosenöffner  
Can opener  
Abre-latas

	Ref	€	cm	L (cm)	U.Venta
<b>A</b>	62689	26,50	5x4	20	6
<b>B</b>	63038	22,20	5x4	17	1

# Afiladores ELÉCTRICOS



new



## Afilador de cuchillos eléctrico TitanPRO

Affûteuse de couteaux électrique  
Elektrische Schärfmaschine  
Electric knife sharpener  
Afiador de facas electrónico

Ref	€	U.Venta
69341	39,10	1

### Ruedas de Alundum blanco

White alundum wheel



## Afilador de cuchillos eléctrico ROND

Affûteuse de couteaux électrique  
Elektrische Schärfmaschine  
Electric knife sharpener  
Afiador de facas electrónico

Ref	€	U.Venta
69141	32,10	1

### Cuchillos lisos y dentados

Smooth and serrated knives

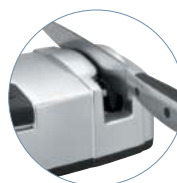

### Cuchillos lisos

Smooth knives



### Rejilla salida viruta

Chip outlet grid

## Afilador de cuchillos eléct. PRO

Affûteuse de couteaux électrique  
Elektrische Schärfmaschine  
Electric knife sharpener  
Afiador de facas electrónico

Ref	€	U.Venta
69261	124,20	1



Fase 1: alta abrasividad · high abrasiveness  
Fase 2: afilado fino · thin sharp  
Fase 3: microafilado · micro-sharp

## Afilador de cuchillos eléctrico MOUSE

Affûteuse de couteaux électrique  
Elektrische Schärfmaschine  
Electric knife sharpener  
Afiador de facas electrónico

Ref	€	U.Venta
60359	49,10	1

- Permiten mantener los utensilios en perfecto estado.
- Diseño elegante, acabado metalizado.
- Dispone de diferentes ranuras para poder afilar distintos tipos de utensilios como cuchillos, tijeras o destornilladores de punta plana.
- El motor gira a la velocidad óptima para que el afilado de los utensilios sea preciso y duradero.
- 100% seguro: en su base se incluyen cuatro ventosas de fijación para evitar que el afilador se mueva durante su uso.

- Permet de maintenir les ustensiles en parfait état.
- Design élégant, finition métallisée.
- Dispose de différentes rainures pour pouvoir aiguiser différents types d'ustensiles tels que des couteaux, des ciseaux ou des tournevis.
- Le moteur tourne à une vitesse optimale pour que l'aiguisage des ustensiles soit précis et durable.
- 100% antidérapant : sa base possède quatre ventouses de fixation pour éviter que l'aiguiser bouge pendant son utilisation.

- Elektrischer Messerschärfer hält Utensilien in einwandfreiem Zustand.
- Elegantes Design in Metalloptik.
- Schlitze zum Schärfen von Messern, Scheren oder Schlitzschraubendreher.
- Optimale Motordrehzahl für einen präzisen und langhaltenden Schliiff.
- 100 % rutschfest dank vierfacher Saugbefestigung, die ein Bewegen des Schärfers bei Gebrauch verhindert.

- Keeping kitchen utensils in perfect condition.
- Elegant design, metallic finish.
- It has different grooves for sharpening different utensils, like knives, scissors and flat-head screwdrivers.
- The motor spins at the optimal speed for precise and long lasting sharpening.
- 100% safe. There are four suction cups on the base to keep the sharpener from moving during use.

- Permiten manter os seus utensílios em perfeito estado.
- Desenho elegante e acabamento metalizado.
- Com diferentes ranhuras para afiar diferentes tipos de utensílios, como facas, tesouras e chaves de parafusos.
- O motor gira a uma velocidade ótima, para um afiar preciso e durável.
- 100% antideslizante: a base possui quatro ventosas de fixação para evitar que o afiador se mova durante a sua utilização.

Ref	Tensión/Voltage	Potencia/Power	Dimensiones/Sizes	Peso/Weight
69341	220-240 V / 50-60 Hz	60 W	17x8x10 cm	0,60 Kg
69141	220-240 V / 50 Hz	60 W	13,5x15x9 cm	0,64 Kg
69261	220-240 V / 50-60 Hz	80 W	32x11,5x10 cm	2,20 Kg
60359	220-240 V / 50-60 Hz	60 W	16x11x7,5 cm	0,56 Kg



# Tablas de corte FIBRA DE MADERA



- Tabla de corte fabricada en fibra de madera, materiales naturales y ecológicos.
- Duradera, resistente, indeformable y anti-bacteriana.
- Las fibras de madera ayudan a mantener el filo de los cuchillos afilado durante más tiempo.
- Su diseño permite darle un doble uso, tanto para la cocina como para el servicio en mesa y se pueden usar por ambos lados.
- GRIPsystem, pies singulares fabricados en silicona para utilizar las tablas en cualquier superficie sin riesgo de deslizamiento.
- El orificio es perfecto para colgar la tabla y facilitar su almacenaje.
- Fácil de limpiar gracias a su acabado liso, no poroso.
- Apta para el lavavajillas.

- Planche à découper fabriquée en fibres de bois, un matériau naturel et écologique.
- Durable, résistante, indéformable et antibactérienne.
- Les fibres de bois aident à maintenir le fil des couteaux aiguisés plus longtemps.
- Sa forme permet de lui donner un double usage, à la fois pour la cuisine et pour le service à table, et elle est utilisable des deux côtés.
- GRIPsystem, pieds exclusifs en silicone pour utiliser les planches sur n'importe quelle surface sans risque de glisser.
- L'orifice est parfait pour suspendre la planche et faciliter son rangement.
- Facile à nettoyer grâce à sa finition lisse, non poreuse.
- Elle est apte pour le lave-vaisselle.

- Schneidebrett aus Holzfaser sowie Natur- und Öko-Stoffen.
- Haltbar, widerstandsfähig, formbeständig und antibakteriell.
- Holzfaser hält Messer länger scharf und schon ihren Schliff.
- Doppelseitig verwendbar für den Einsatz in der Küche oder als Servierbrett.
- GRIPsystem exklusive Füße aus Silikon, um die Bretter auf jeder Oberfläche ohne Rutschgefahr zu verwenden.
- Praktische Öffnung zum Aufhängen oder Verstauen.
- Glatte, porenfreie Oberfläche ist einfach zu reinigen.
- Spülmaschinengeeignet.

- Chopping board made from wood fibre, a natural and eco-friendly material.
- Durable, resistant, anti-bacterial and its shape doesn't warp.
- The wood fibres help keep the knife blade sharper for longer.
- Its design allows you to use both for the kitchen and for serving food on the table.
- GRIPsystem, exclusive feet made of silicone to use the boards on any surface without risk of slipping.
- The hole is perfect for hanging the board and it makes it easier to store.
- It's easy to clean thanks to its smooth, non-porous finish.
- It's suitable for washing machines.

- Tábua de cortar fabricada em fibra de madeira, materiais naturais e ecológicos.
- Durável, resistente, indeformável e antibactérias.
- As fibras de madeira ajudam a manter a lâmina das facas afiada durante mais tempo.
- O seu design proporciona-lhe uma dupla utilidade: tanto para a cozinha quanto para servir à mesa. Utilizável por ambos os lados.
- GRIPsystem, pés exclusivos feitos de silicone para usar as pranchas em qualquer superfície sem risco de escorregar.
- Orifício para pendurar a tábua, e facilitar o seu armazenamento.
- Fácil de limpar, graças ao seu acabamento liso e não poroso.
- Apta para a máquina de lavar louça.

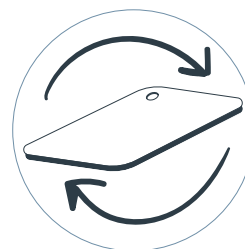

## Tablas de corte reversibles Reversible cutting boards



### Tabla de corte BLACK

Planche à découper  
Schneidebrett  
Cutting board  
Tábua de corte

Ref	€	cm	e (mm)	U.Venta
60580	18,20	30x21,5	6	1
60581	24,50	37x27,5	6	1
60582	34,80	44x32,5	6	1

Orificio para colgar  
Hanging hole



GRIPsystem

Juntas laterales antideslizantes en silicona  
Non-slip silicone side seals

Fibra de madera, natural y ecofriendly  
Wood fiber, natural and ecofriendly

Antibacteriana  
Antibacterial



### Tabla de corte NATURAL

Planche à découper  
Schneidebrett  
Cutting board  
Tábua de corte

Ref	€	cm	e (mm)	U.Venta
60583	19,20	30x23,5	6	1
60584	23,60	37x27,5	6	1
60585	33,90	44x32,5	6	1

**Orificio para colgar**

Hanging hole



*GRIPsystem*

**Juntas laterales antideslizantes en silicona**

Non-slip silicone side seals

**Canal que recoge el jugo de los alimentos**

Channel that collects the juice from your food

**Fibra de madera, natural y Ecofriendly**

Wood fiber, natural and Ecofriendly

**Antibacteriana**

Antibacterial



### Tabla de corte NOGAL

Planche à découper  
Schneidebrett  
Cutting board  
Tábua de corte

Ref	€	cm	e (mm)	U.Venta
60586	16,70	26,5x19,5	6	1
60587	21,10	30x23,5	6	1
60588	32,90	40x30	6	1

**Orificio para colgar**

Hanging hole



*GRIPsystem*

**Juntas laterales antideslizantes en silicona**

Non-slip silicone side seals

**Canal que recoge el jugo de los alimentos**

Channel that collects the juice from your food

**Fibra de madera, natural y Ecofriendly**

Wood fiber, natural and Ecofriendly

**Antibacteriana**

Antibacterial



### Tabla de corte pan BLACK

Planche à découper pain  
Schneidebrett brot  
Bread cutting board  
Tábua de corte pão

Ref	€	Ø (cm)	h (cm)	U.Venta
60589	30,90	40x25	0,65	1

*GRIPsystem*

**Juntas laterales antideslizantes en silicona**

Non-slip silicone side seals

**Antibacteriana**

Antibacterial

**Orificio para colgar**

Hanging hole

**Superficie lisa y acanalada (8 canales)**

Smooth and ribbed surface (8 channels)

**Fibra de madera, natural y Ecofriendly**

Wood fiber, natural and Ecofriendly



### Tabla de corte pan NOGAL

Planche à découper pain  
Schneidebrett brot  
Bread cutting board  
Tábua de corte pão

Ref	€	Ø (cm)	h (cm)	U.Venta
60590	30,30	40x25	0,65	1

*GRIPsystem*

**Juntas laterales antideslizantes en silicona**

Non-slip silicone side seals

**Antibacteriana**

Antibacterial

**Orificio para colgar**

Hanging hole

**Superficie lisa y acanalada (8 canales)**

Smooth and ribbed surface (8 channels)

**Fibra de madera, natural y Ecofriendly**

Wood fiber, natural and Ecofriendly



# Tablas de corte **MADERA**



- Ideales para cortar todo tipo de alimentos.
- Perfectas para colocar sobre la encimera de la cocina.
- Madera tratada con un revestimiento protector y antibacteriana.
- Diseñada para cuidar y conservar el filo de los cuchillos.
- Ligeras y resistentes. Higiénicas y fáciles de limpiar.

- Idéales pour couper tout type d'aliments.
- Parfaites pour installer sur le plan de travail de la cuisine.
- Bois traité avec un revêtement protecteur et antibactérien.
- Conçues pour prendre soin et préserver le fil des couteaux.
- Légères et résistantes. Hygiéniques et faciles à nettoyer.

- Ideal zum Schneiden aller möglichen Zutaten.
- Passen perfekt auf die Arbeitsfläche in der Küche.
- Holz mit antibakterieller Schutzbeschichtung.
- Schonen Klingen und erhalten den Schliiff.
- Leicht und widerstandsfähig. Hygienisch und leicht zu reinigen.

- Ideal for cutting any type of food.
- Perfect for placing on kitchen counters.
- The wood is treated with a protective antibacterial finish.
- Designed to conserve and protect the edges of your knives.
- Lightweight and strong. Hygienic and easy to clean.

- Ideais para cortar todo o tipo de alimentos.
- Prefeitas para colocar sobre a bancada da cozinha.
- Madeira tratada com revestimento protetor e antibacteriano.
- Concebida para cuidar e conservar o fio das lâminas.
- Leves e resistentes. Higiénicas e fáceis de limpar.

*new*

Orificio para colgar  
Hanging hole

Tablas reversibles  
Reversibles cutting boards



**Bambú**

Bamboo

## Set 3 tablas de corte

Set 3 planches à découper  
Set 3 Schneiderbrett  
3 cutting boards set  
Conjunto 3 tábuas de corte

Ref	€	cm	U.Venta
60523	17,80	20x15	1
		20x22	
		33x25	



**Bambú**

Bamboo

## Tabla de corte pan

Planche à découper pain  
Schneidebrett brot  
Bread cutting board  
Tábua de corte pão

Ref	€	cm	h (cm)	U.Venta
60487	28,70	40x30	2	1



**Bambú**

Bamboo

## Tabla de corte pan oval

Planche à découper pain ovale  
Schneidebrett oval brot  
Oval bread cutting board  
Tábua de corte pão oval

Ref	€	cm	h (cm)	U.Venta
60491	35,80	40x27	3	1



**Bambú**

Bamboo

## Tabla de corte pan

Planche à découper pain  
Schneidebrett brot  
Bread cutting board  
Tábua de corte pão

Ref	€	cm	h (cm)	U.Venta
60495	22,60	50x15	2	1



**Reversible**  
Double-sided

**Canal recoge jugos**  
Groove collects juices

**Bambú**

Bamboo

### Tabla de corte DUAL

Planche à découper  
Schneidebrett  
Cutting board  
Tábua de corte

Ref	€	cm	h (cm)	U.Venta
60492	36,60	39,5x38	4	1

**Incluye cubeta**  
Includes container



**Pies antideslizantes**  
Non-slip feet

**Bambú**

**PP**

Bamboo

Polypropylene



### Tabla de corte COLLET HOME

Planche à découper  
Schneidebrett  
Cutting board  
Tábua de corte

Ref	€	Tabla (cm)	Cubeta (cm)	U.Venta
60594	29,80	35x29x4	-	1
R60594A	4,80	-	34x26,5x2	1

**Cubeta** · Tray



**Incluye cubeta**  
Includes container

### Tabla de corte COLLECT GN 2/3

Planche à découper  
Schneidebrett  
Cutting board  
Tábua de corte

Ref	€	Tabla (cm)	Cubeta (cm)	Cubeta (L)	U.Venta
60592	71,00	41,5x34x7	-	-	1
*66540Z	22,10	-	35,4x32,5x4	3,50	1

**Cubeta** · Tray

\* **Apta cubeta inox 18/10 (66540)** · Suitable for 18/10 stainless steel tray (66540)



**Incluye cubetas**  
Includes containers

### Tabla de corte COLLECT 2xGN 1/2

Planche à découper  
Schneidebrett  
Cutting board  
Tábua de corte

Ref	€	Tabla (cm)	Cubeta (cm)	Cubeta (L)	U.Venta
60591	99,50	61,5x34x7	-	-	1
*66240Z	11,70	-	26,5x32,5x4	2,5 x 2	1

**Cubeta** · Tray

\* **Apta cubeta inox 18/10 (66240)** · Suitable for 18/10 stainless steel tray (66240)

**Las fibras colocadas verticalmente, mantienen el filo de los cuchillos**

The fibres placed vertically, maintain the edge of the knives

**Revestimiento protector y anti-bacteriano**

Protective and anti-bacterial coating

**Madera Caucho**

Rubber Wood



### Tabla de corte RUBBER WOOD

Planche à découper  
Schneidebrett  
Cutting board  
Tábua de corte

Ref	€	cm	h (cm)	U.Venta
60488	35,00	33x25	4	1
60485	68,40	53,3x32,8	4	1

*new*



**Apertura por ambos lados**  
Opening on both sides

**Pies antideslizantes**  
Non-slip feet

**Bambú**

Bamboo

### Tabla de corte COLLET

Planche à découper  
Schneidebrett  
Cutting board  
Tábua de corte

Ref	€	cm	h (cm)	U.Venta
60595	30,30	40x26	5	1

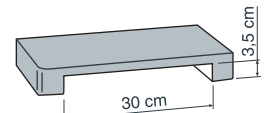

**Gran apertura**  
Large tall opening

**Madera Caucho**

Rubber Wood

**Inox**

- **Práctica tabla de corte con una o dos cubetas de acero inoxidable ocultas completamente extraíbles.**
- **Las fibras colocadas verticalmente ayudan a mantener el filo de los cuchillos afilado durante más tiempo.**
- **Tabla de corte tratada con un revestimiento protector y anti-bacteriana.**
- **Cubeta extraíble para recoger los alimentos cortados.**
- **Cubeta apta para el horno (hasta 250°C) y el lavavajillas.**
- **Pies antideslizantes, garantiza la estabilidad de la tabla durante el corte.**

- Planche à découper pratique avec un ou deux bac en acier inoxydable totalement extractibles.
- Les fibres placées verticalement aident à maintenir le fil de la lame des couteaux aiguisés plus longtemps.
- Planche à découper traitée avec un revêtement de protection et antibactérien.
- Bacs extractibles pour accueillir les aliments coupés.
- Bacs aptes pour le four (jusqu'à 250 °C) et le lave-vaisselle.
- Pieds antidérapants qui garantissent la stabilité de la planche à découper pendant la découpe.

- Handy cutting board with one or two completely removable stainless steel trays.
- The fibres are arranged vertically to help knife blades retain their sharpness for longer.
- Cutting board treated with a protective and anti-bacterial coating.
- Removable tray for collecting chopped food.
- Tray is oven-safe (up to 250°C) and dishwasher-safe.
- Non-slip feet ensure the board remains stable when cutting.

# Tablas de corte **QUESO**



**60072**

- Fabricada en robusta madera de acacia.
- Superficie de corte en cristal con un Ø25 cm.
- Incluye 4 cuchillos fabricados en acero inoxidable con mango de madera.
- Ideal para cortar quesos y presentarlos sobre la misma.

- Fabriquée en bois d'acacia robuste.
- Surface de découpe en verre avec un Ø de 25 cm.
- Inclut 4 couteaux fabriqués en acier inoxydable avec manche en bois.
- Idéale pour couper le fromage et le présenter à table.

- Aus robustem Akazienholz gefertigt.
- Schneidefläche aus Glas mit einem Durchmesser von Ø25 cm.
- Dazu gehören 4 Messer aus Edelstahl mit Holzgriff.
- Ideal zum Käse schneiden und präsentieren.

- Made of sturdy acacia wood.
- Ø25cm glass cutting surface.
- Includes 4 stainless steel knives with wooden handles.
- Ideal for cutting and serving cheese.



- Fabricada em madeira de acácia de grande robustez.
- Superfície de corte de vidro, com Ø25 cm.
- Inclui 4 facas de aço inoxidável, com cabo de madeira.
- Ideal para cortar e apresentar queijos.

**62004**

- Quesera compuesta por base de madera de acacia natural y tapa de plástico, libre de BPA.
- Práctica y funcional; corta, presenta y conserva los alimentos en las mejores condiciones.
- Tapa en forma de campana con pomo para facilitar su manipulación.

- Plateau à fromage composé d'un plateau en bois d'acacia naturel et d'une cloche en plastique, sans BPA.
- Pratique et fonctionnel ; coupez, présentez et conservez les aliments dans les meilleures conditions.
- Cloche avec pommeau pour faciliter sa prise en mai

- Käseglocke mit Unterlage aus biologischem Akazienholz und Kunststoffabdeckung. BPA-frei.
- Praktisch und zweckmäßig. Zum Schneiden, Servieren und Aufbewahren von Aufschnitt.
- Glockenförmige Abdeckung mit praktischem Knauf.

- Cheese dome with a natural acacia wood base and a plastic cover. BPA free.
- Practical and functional. Cut, present and conserve food under the best conditions.
- The cover is bell shaped and has a handle so it's easy to use.

- Queijeira composta por uma base de madeira de acácia, com tampa de plástico, livre de BPA.
- Prática e funcional; para cortar apresentar e conservar os alimentos nas melhores condições.
- Tampa em forma de campânula, com pomo para facilitar a sua manipulação.

**Base de cristal de Ø25 cm**  
Ø25 cm glass base



**Tapa tipo campana**  
Bell-like lid



*new*

**Cristal**

Glass

## Set cuchillos para queso

Jeu de couteaux pour le fromage  
Set von Messern für Käse  
Knives set  
Jogo de facas para queijo

Ref	€	Ø (cm)	h (cm)	U.Venta
60072	47,00	25	5	1

**AS**

Plastic



## Quesera KEEP

Plateau à fromage avec cloche  
Käseglocke  
Cheese dome  
Queijeira

**Para cortar, presentar y conservar**  
To cut, present and preserve

Ref	€	cm	h Total (cm)	U.Venta
62004	25,30	28,5x18,5	10	1

# Tablas de corte **POLIPROPILENO · POLIETILENO**

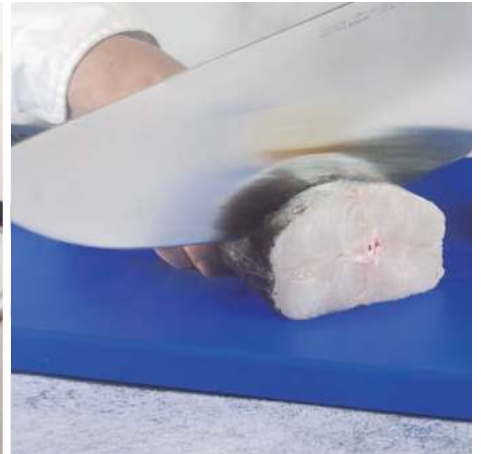

- Ideales para cortar todo tipo de alimentos.
- Perfectas para colocar sobre la encimera de la cocina.
- Ligeras y resistentes.
- Antibacterianas.
- Higiénicas y fáciles de limpiar.
- Aptas para el lavavajillas.

- Idéales pour couper tout type d'aliments.
- Parfaites pour installer sur le plan de travail de la cuisine.
- Légères et résistantes.
- Antibactérien.
- Hygiéniques et faciles à nettoyer.
- Aptes pour le lave-vaisselle.

- Ideal zum Schneiden aller möglichen Zutaten.
- Passen perfekt auf die Arbeitsfläche in der Küche.
- Leicht und widerstandsfähig.
- Antibakteriell.
- Hygienisch und leicht zu reinigen.
- Spülmaschinengeeignet.

- Ideal for cutting any type of food.
- Perfect for placing on kitchen counters.
- Lightweight and strong.
- Antibacterial.
- Hygienic and easy to clean.
- Dishwasher safe.

- Ideais para cortar todo o tipo de alimentos.
- Preferitas para colocar sobre a bancada da cozinha.
- Leves e resistentes.
- Antibacteriano.
- Higiénicas e fáceis de limpar.
- Aptas para máquinas de lavar louça.

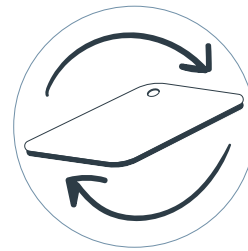

**Tablas de corte reversibles**  
Reversible cutting boards

*new*

**Orificio para colgar**  
Hanging hole



**PP**

Polypropylene

## Set 3 tablas de corte

Set 3 planches à découper  
Set 3 Schneiderbrett  
3 cutting boards set  
Conjunto 3 tábuas de corte

Ref	€	cm	U.Venta
60500	13,20	20x15	1
		30x20	
		35x25	

**Orificio para colgar**  
Hanging hole



**PP**

Polypropylene

## Set 3 tablas de corte OCEAN

Set 3 planches à découper  
Set 3 Schneiderbrett  
3 cutting boards set  
Conjunto 3 tábuas de corte

Ref	€	cm	U.Venta
60555	13,20	20x15	1
		30x20	
		35x25	

**Asa para facilitar su manejo**  
Handle for easy handling

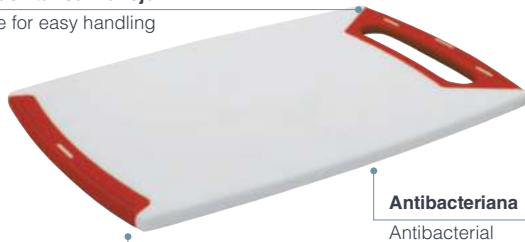

**PP**

Polypropylene

**Tabla de corte**

Planche à découper  
Schneidebrett  
Cutting board  
Tábua de corte

**Tope de silicona antideslizante**  
Non-slip silicone stopper

**Antibacteriana**  
Antibacterial

Ref	€	cm	h (cm)	U.Venta
60501	8,10	30x18	1	1
60502	11,10	36x22	1	1
60503	14,90	42x25,5	1	1

**Canal que recoge el jugo de los alimentos**  
Channel that collects the juice from your food



**PE**

Polyethylene

**Tabla de corte DUAL**

Planche à découper  
Schneidebrett  
Cutting board  
Tábua de corte

**Reversible**  
Double-sided

**Antibacteriana**  
Antibacterial

Ref	€	cm	h (cm)	U.Venta
60459	28,40	35x43	5	1

- Especial para preparar comidas que no contengan alérgenos.
- Identifíquela rápidamente por su intenso color morado.

- Specially made for making food that contains no allergens.
- Identify it quickly by its deep purple colouring.

**Especial para alérgicos**  
Special for allergy sufferers

**Antibacteriana**  
Antibacterial



**Tacos antideslizantes**  
Non slip plugs



**PE**

Polyethylene

**Tabla de corte antialérgica**

Planche à découper  
Schneidebrett  
Anti-allergy cutting board  
Tábua de corte

**GN 1/2 · 325x265 mm**

Ref	€	h (mm)	U.Venta
60521	24,00	20	1

**GN 1/1 · 530x325 mm**

Ref	€	h (mm)	U.Venta
60522	48,00	20	1

**600x400 mm**

Ref	€	h (mm)	U.Venta
60606	58,70	20	1

**PE-500 (HD-HMW) High Molecular AA Weight Polyethylene**

**Antibacteriana**  
Antibacterial

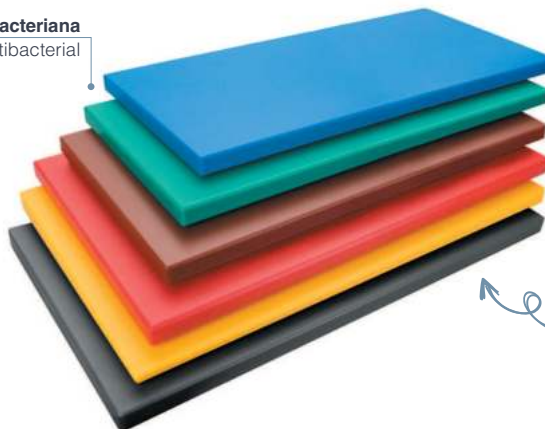

- Pescado · Fish** ■
- Verduras+frutas · Vegetables+Fruits** ■
- Embutidos · Cold cred meat** ■
- Carne · Meat** ■
- Aves · Poultry** ■
- Varios · Various** ■

**Tacos antideslizantes**  
Non slip plugs

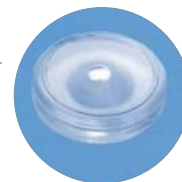

**PE**

Polyethylene

**Tabla de corte**

Planche à découper  
Schneidebrett  
Cutting board  
Tábua de corte

**GN 1/4 · 265x162 mm**

Ref	€	h (mm)	U.Venta
60570	10,80	20	1
60571	10,80	20	1
60572	10,80	20	1
60573	10,80	20	1
60574	10,80	20	1
60577	10,80	20	1

**GN 1/2 · 325x265 mm**

Ref	€	h (mm)	U.Venta
60470	21,10	20	1
60471	21,10	20	1
60472	21,10	20	1
60473	21,10	20	1
60474	21,10	20	1
60480	21,10	20	1

**GN 1/1 · 530x325 mm**

Ref	€	h (mm)	U.Venta
60475	41,60	20	1
60476	41,60	20	1
60477	41,60	20	1
60478	41,60	20	1
60576	117,80	50	1
60479	41,60	20	1
60481	41,60	20	1

**600x400 mm**

Ref	€	h (mm)	U.Venta
60600	59,20	20	1
60601	59,20	20	1
60602	59,20	20	1
60603	59,20	20	1
60604	59,20	20	1
60605	59,20	20	1

**PE-500 (HD-HMW) High Molecular AA Weight Polyethylene**

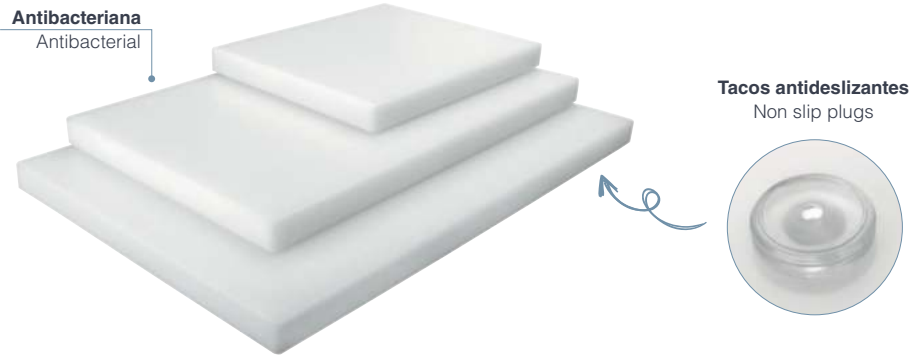

**PE**

Polyethylene

### Tabla de corte polietileno

Planche à découper en polyéthylène  
Schneidebret Polyethylen  
Polyethylene cutting board  
Tábua de corte polietileno

GN 1/4 · 265x162 mm				GN 1/2 · 325x265 mm				GN 1/1 · 530x325 mm				600x400 mm			
Ref	€	h (mm)	U.Venta	Ref	€	h (mm)	U.Venta	Ref	€	h (mm)	U.Venta	Ref	€	h (mm)	U.Venta
60569	10,80	20	6	60455	21,10	20	6	60456	41,80	20	1	60457	58,90	20	1
				60405	31,00	30	6	60406	62,30	30	1	60407	87,20	30	1
								60575	120,90	50	1				



**PE Inox**

Polyethylene

Cubeta Container

### Tabla de corte COLLECT GN 2/3

Planche à découper  
Schneidebrett  
Cutting board  
Tábua de corte

Ref	€	Tabla (cm)	Cubeta (cm)	Cubeta (L)	U.Venta
60593	99,40	41x34x6,5	-	-	1
*66540Z	22,10	-	35,4x32,5x4	3,5	1

\* Apta cubeta Inox 18/10 (66540) · Suitable for 18/10 stainless steel tray (66540)

- Práctica tabla de corte con una cubeta GN 2/3 de acero inoxidable oculta completamente extraíble.
- Fabricada en polietileno de alta densidad de color blanco.
- Segura, ligera e higiénica, no absorbe humedad y evita la proliferación de bacterias.
- Gracias a su superficie suave, protege las hojas de los cuchillos.
- Cubeta extraíble (35,4x32,5x4 cm) para recoger los alimentos cortados.
- Cubeta apta para el horno (hasta 250°C) y el lavavajillas.
- Pies antideslizantes, garantiza la estabilidad de la tabla durante el corte.
- Resistente a los cortes y los arañazos.

- Planche à découper pratique avec un bac GN 2/3 en acier inoxydable totalement extractibles.
- Fabriquée en polyéthylène de haute densité de couleur blanche.
- Sûre, légère et hygiénique, elle n'absorbe pas l'humidité et évite la prolifération des bactéries.
- Grâce à sa surface douce, elle protège les lames des couteaux.
- Bacs extractibles (35,4x32,5x4 cm) pour accueillir les aliments coupés.
- Bacs aptes pour le four (jusqu'à 250 °C) et le lave-vaisselle.
- Pieds antidérapants qui garantissent la stabilité de la planche à découper pendant la découpe.
- Résistante aux coupures et aux rayures.

- Handy cutting board with one completely removable stainless steel GN 2/3 tray.
- Made of white high-density polyethylene.
- Safe, light and hygienic, it does not absorb moisture and prevents the growth of bacteria.
- It protects knife blades thanks to its smooth surface.
- Removable tray (35,4x32,5x4 cm) for collecting chopped food.
- Tray is oven-safe (up to 250°C) and dishwasher-safe.
- Non-slip feet ensure the board remains stable when cutting.
- Resistant to cuts and scratches.



**PE**

Polyethylene

### Cepillo para tablas de corte

Brosse pour planche à découper  
Brush für Schneidebrett  
Brush cutting board  
Cepilho para tábua de corte

Ref	€	cm	h (cm)	U.Venta
60458	66,30	17x6	10	1

**Para uso de tablas de polietileno profesionales**  
For use of Professional Polyethylene cutting boards

**Renueva las tablas, eliminando las rayas o pequeñas grietas**  
Renew the boards, eliminating scratches or small cracks



# Colección CUBIERTOS INOX



## HOTEL

Inox  
18% Cr

Espesor · Thickness: 1,8 mm

Ref	€	U.Venta	
33101	1,70	12	<b>Cuchara mesa</b> · Table spoon
33102	1,70	12	<b>Tenedor mesa</b> · Table fork
33103	2,80	12	<b>Cuchillo mesa</b> · Table knife
33104	1,40	12	<b>Cuchara postre</b> · Dessert spoon
33105	1,40	12	<b>Tenedor postre</b> · Dessert fork
33106	2,70	12	<b>Cuchillo postre</b> · Dessert knife
33107	1,10	12	<b>Cuchara café</b> · Coffee spoon
33108	0,90	12	<b>Cuchara moka</b> · Moka spoon
33109	1,10	12	<b>Tenedor Lunch</b> · Lunch fork



## ARIES

Inox  
18/10

Espesor · Thickness: 2,5 mm

Ref	€	U.Venta	
33401	2,70	12	<b>Cuchara mesa</b> · Table spoon
33402	2,70	12	<b>Tenedor mesa</b> · Table fork
33403	6,00	12	<b>Cuchillo mesa</b> · Table knife
33404	2,70	12	<b>Cuchara postre</b> · Dessert spoon
33405	2,70	12	<b>Tenedor postre</b> · Dessert fork
33406	6,00	12	<b>Cuchillo postre</b> · Dessert knife
33407	1,40	12	<b>Cuchara café</b> · Coffee spoon
33408	1,30	12	<b>Cuchara moka</b> · Moka spoon
33409	1,70	12	<b>Tenedor Lunch</b> · Lunch fork
33410	2,70	12	<b>Tenedor pescado</b> · Fish fork
33411	2,70	12	<b>Pala pescado</b> · Fish knife
33412	10,60	1	<b>Cazo sopa</b> · Soup ladle
33413	6,50	1	<b>Cuchara servir</b> · Serving spoon
33414	6,60	1	<b>Tenedor servir</b> · Serving fork
33415	8,40	1	<b>Cacillo salsa</b> · Gravy shovel
33416	7,20	1	<b>Pala pastel</b> · Cake shovel



# Colección CUBERTEROS



## Soporte cubiertos c/vasos

Porte couverts avec paniers  
Besteckbehälter  
St. Steel cutlery holder w/cylinder  
Suporte talheres com copos

Ref.	€	cm	Orif.	U.Venta
33124	84,70	29x22x26	4	1
33126	104,10	29x22x38	6	1

## Vasos inox cubertería

Panier pour porte couvert  
Besteckköcher  
St. steel cutlery cylinder  
Copos p/talheres inóx



Ref.	€	h (cm)	U.Venta
33125	7,60	14	6

Compartimento hueco  
Hollow compartment  
11x25x9 cm



4 compartimentos  
4 compartments



- Recipiente para cubiertos en color negro de polipropileno.
- Ideal para organizar y guardar los cubiertos e utensilios de la cocina.
- No se deforma con el peso de los cubiertos.
- Cómodo de transportar gracias a sus asas laterales.
- Fondo redondeado para un fácil mantenimiento.
- Apilable.

- Pot à couverts en polypropylène noir.
- Idéal pour organiser et ranger les couverts et les ustensiles de cuisine.
- Il ne se déforme pas avec le poids des couverts.
- Confortable à transporter grâce à ses poignées latérales.
- Fond arrondi pour un entretien facile.
- Empilable.

- Black polypropylene cutlery container.
- Ideal for organizing and storing cutlery and kitchen utensils.
- It does not deform with the weight of the cutlery.
- Comfortable to transport thanks to its side handles.
- Rounded bottom for easy maintenance.
- Stackable.

## Cubertero GN 1/1

Range-couverts  
Besteckkasten  
Cutlery holder  
Bandeja pata talheres

Ref	€	cm	h (cm)	U.Venta
33121	11,20	52,5x32	9,5	1

new

A

Trenzados  
Braided



B



C

Bastidor cromado reforzado  
Reinforced chrome frame



4 compartimentos  
4 compartments

## Cubertero RATTAN PP

Range-couverts  
Besteckkasten  
Cutlery holder  
Bandeja pata talheres

	Ref	€	cm	h (cm)	Comp.	U.Venta
A	63484	8,40	27x10	4,5	1	1
B	63485	8,40	∅12	15,0	1	1
C	63491	74,80	53x32,5	9,0	4	1

---

# Buffet

---

Buffet





**Chafing dish**  
Chafing dish

**Buffet**  
Buffet

# Colección chafing dish **LUXE**

Inox  
18/10



Vitro



Electric



Gas



Induction



- Tapa con descenso amortiguado para un cierre suave.
- Tapa extraíble verticalmente para su limpieza.
- Visor de cristal.
- Las gotas de condensación retornan a la cubeta.
- Salsera lateral para la sujeción de cacillos o espumaderas.
- Disponibilidad de aro complementario para el empleo de placa de inducción.

- Couvercle avec descente amortie pour une fermeture en douceur.
- Couvercle peut s'extraire verticalement pour un nettoyage aisé.
- Écran en verre.
- Les gouttelettes de condensation retombent dans la cuvette.
- Saucière latérale pour la fixation de louches ou d'écumoirs.
- Disponibilité d'anneaux complémentaires pour l'utilisation de plaques à induction.

- Deckel mit gefederter Abwärtsbewegung für sanftes Schließen.
- Deckel zwecks einfacher Reinigung vertikal abnehmbar.
- Schauglas.
- Rückfluss der Kondensatropfen in den Wasserbehälter.
- Seitliche Sauciere für die Ablage von Schöpfkelle oder Schaumlöffel nach Gebrauch.
- Zusatzringe für den Einsatz von Induktionsplatten verfügbar.

- Cover with damping seal for smooth closure.
- Cover can be removed vertically for easy cleaning.
- Glass display.
- The condensation droplets return to the receptacle.
- Lateral sauceboat for holding scoops and skimmers.
- Availability of additional rings for the use of induction hobs.

- Tampa com descida amortecida que se fecha suavemente.
- Tampa pode ser extraída verticalmente para facilitar a limpeza.
- Visor de vidro.
- As gotas de condensação regressam à cubeta.
- Molheira lateral para sujeitar as conchas ou escumadeiras.
- Anéis complementares disponíveis para utilizar em placas de indução.





### Chafing dish GN 1/1 LUXE

Bain marie GN 1/1  
Chafing Dish, GN-Einsatz 1/1  
GN 1/1 chafing dish  
Chafing dish GN 1/1 steel

Ref	€	cm	h (cm)	L	U.Venta
69091	1.010,60	47x59,5	43,0	9,0	1



### Cuerpo chafing dish GN 1/1 LUXE

Corps bain marie GN 1/1  
Chafing Dish Körper, GN-Einsatz 1/1  
GN 1/1 chafing dish body  
Corpo chafing dish GN 1/1

Ref	€	cm	h (cm)	L	U.Venta
69099	813,10	59,5x47	25,0	9,0	1



### Soporte chafing dish GN 1/1 LUXE

Support Bain marie GN 1/1  
Gestell für Chafing Dish1/1  
GN 1/1 chafing dish stand  
Suporte chafing dish GN 1/1

Ref	€	cm	h (cm)	U.Venta
69089	197,40	41x55	17,0	1



### Placa inducción c/regulador

Plaque à induction avec regulateur  
Induktionskochfeld mit regler  
Round induction plate with power control  
Placa de indução com regulador

Ref	€	W	cm	U.Venta
69131	113,90	1000	Ø24x8	1

Placa encastrable. Necesita agujero de Ø216 mm para introducirla.  
Encastable plate. Need a Ø216 mm hole to insert the plate.



### Aro complemento chafing dish

Support plaque induction  
Zusatzring chafing-dish  
Chafing-dish heater holder  
Aro complemento chafing dish

Ref	€	Ø (cm)	U.Venta
R69099B	18,70	26	1

### Salsera chafing dish

Saucière chafing-dish Luxe  
Sauciere Chafing Dish, Luxe  
Gravy spoon holder  
Molheira chafing dish



Ref	€	cm	h (cm)	L	U.Venta
R69099C	15,90	12x23	4,0	0,40	1



### Chafing dish GN 2/3 LUXE

Bain marie GN 2/3  
Chafing Dish, GN-Einsatz 2/3  
GN 2/3 chafing dish  
Chafing dish GN 2/3

Ref	€	cm	h (cm)	L	U.Venta
69092	804,70	43x46	58,5	5,5	1



### Placa inducción con regulador

Plaque à induction avec regulateur  
Induktionskochfeld mit regler  
Round induction plate with power control  
Placa de indução com regulador



Ref	€	W	cm	U.Venta
69131	113,90	1000	Ø24x8	1

Placa encastrable. Necesita agujero de Ø216 mm para introducirla.  
Encastable plate. Need a Ø216 mm hole to insert the plate.

### Cuerpo chafing dish GN 2/3 LUXE

Corps bain marie GN 2/3  
Chafing Dish Körper, GN-Einsatz 2/3  
GN 2/3 chafing dish body  
Corpo chafing dish GN 2/3

Ref	€	cm	h (cm)	L	U.Venta
69095	635,60	46x43	25,5	5,5	1



### Aro complemento chafing dish

Support plaque induction  
Zusatzring chafing-dish  
Chafing-dish heater holder  
Aro complemento chafing dish

Ref	€	Ø (cm)	U.Venta
R69099B	18,70	26	1



### Soporte chafing dish LUXE GN 2/3

Support Bain marie GN 2/3  
Gestell für Chafing Dish 2/3  
GN 2/3 chafing dish stand  
Suporte chafing dish GN 2/3

Ref	€	cm	h (cm)	U.Venta
69087	169,10	40x37	17,0	1

### Salsera chafing dish

Saucière chafing-dish Luxe  
Sauciere Chafing Dish, Luxe  
Gravy spoon holder  
Molheira chafing dish



Ref	€	cm	h (cm)	L	U.Venta
R69099C	15,90	12x23	4,0	0,40	1



### Chafing dish GN 1/2 LUXE

Bain marie GN 1/2  
Chafing Dish, GN-Einsatz 1/2  
GN 1/2 chafing dish  
Chafing dish GN 1/2 steel

Ref	€	cm	h (cm)	L	U.Venta
69093	725,20	32,5x46	44,5	4,0	1



### Cuerpo chafing dish LUXE GN 1/2

Corps bain marie GN 1/2  
Chafing Dish Körper, GN-Einsatz 1/2  
GN 1/2 chafing dish body  
Corpo chafing dish GN 1/2

Ref	€	cm	h (cm)	L	U.Venta
69094	585,60	46x32,5	25,5	4,0	1



### Soporte chafing dish GN 1/2 LUXE

Support Bain marie GN 1/2  
Gestell für Chafing Dish 1/2  
GN 1/2 chafing dish stand  
Suporteio chafing dish GN 1/2

Ref	€	cm	h (cm)	U.Venta
69088	139,50	40x28	17,0	1



### Placa inducción con regulador

Plaque à induction avec regulateur  
Induktionskochfeld mit regler  
Round induction plate with power control  
Placa de indução com regulador

Ref	€	W	cm	U.Venta
69139	113,20	700	Ø18x8	1

Placa encastrable. Necesita agujero de Ø216 mm para introducirla.  
Encastable plate. Need a Ø216 mm hole to insert the plate.



### Aro complemento chafing dish

Support plaque induction  
Zusatzring chafing-dish  
Chafing-dish heater holder  
Aro complemento chafing dish

Ref	€	Ø (cm)	U.Venta
R69094A	18,90	18	1

### Salsera chafing dish

Saucière chafing-dish Luxe  
Sauciere Chafing Dish, Luxe  
Gravy spoon holder  
Molheira chafing dish



Ref	€	cm	h (cm)	L	U.Venta
R69099C	15,90	12x23	4,0	0,40	1





## Chafing dish SOPA LUXE

Bain marie soupiere  
Suppen Chafing Dish  
Soup chafing dish  
Chafing dish sopa

Ref	€	Ø (cm)	h (cm)	L	U.Venta
69098	640,90	45	57,0	11,0	1



## Placa inducción con regulador

Plaque à induction avec regulateur  
Induktionskochfeld mit regler  
Round induction plate with power control  
Placa de indução com regulador



Ref	€	W	cm	U.Venta
69131	113,90	1000	Ø24x8	1

Placa encastrable. Necesita agujero de Ø216 mm para introducirla.  
Encastable plate. Need a Ø216 mm hole to insert the plate.

## Cuerpo chafing dish SOPA LUXE

Corps bain marie soupiere  
Suppen Chafing Dish Körper  
Soup chafing dish body  
Corpo chafing dish sopa

Ref	€	Ø (cm)	h (cm)	L	U.Venta
69100	471,00	45	38,0	11,0	1



## Aro complemento chafing dish

Support plaque induction  
Zusatzring chafing-dish  
Chafing-dish heater holder  
Aro complemento chafing dish



Ref	€	Ø (cm)	U.Venta
R69100B	19,30	27	1

## Contenedor chafing dish LUXE SOPA

SOUPIERE Bain marie Luxe  
Suppenbehälter chafing Dish, Luxe  
Luxe soup container chafing dish  
Recipiente chafing dish Luxe sopa



Ref	€	Ø (cm)	h (cm)	L	U.Venta
R69100A	25,10	29	22,0	11,0	1

## Soporte chafing dish SOPA LUXE

Support bain marie soupiere  
Gestell für Suppen Chafing Dish  
Soup chafing dish stand  
Suporte chafing dish sopa

Ref	€	cm	h (cm)	U.Venta
69097	170,00	41x32	17,0	1

## Salsera chafing dish

Saucière chafing-dish Luxe  
Sauciere Chafing Dish, Luxe  
Gravy spoon holder  
Molheira chafing dish



Ref	€	cm	h (cm)	L	U.Venta
R69099C	15,90	12x23	4,0	0,40	1



### Chafing dish REDONDO LUXE

Bain marie rounde  
Chafing Dish, rund  
Round chafing dish  
Chafing dish redondo steel

Ref	€	cm	h (cm)	L	U.Venta
69101	796,40	46,5x53	45,0	6,0	1



### Cuerpo chafing dish REDONDO LUXE

Corps bain marie rounde  
Chafing Dish Körpe, rund  
Round chafing dish body  
Corpo chafing dish redondo

Ref	€	cm	h (cm)	L	U.Venta
69096	626,50	46,5x53	25,0	6,0	1



### Soporte chafing dish SOPA LUXE

Support bain marie soupriere  
Gestel für Suppen Chafing Dish  
Soup chafing dish stand  
Suporte chafing dish sopa

Ref	€	cm	h (cm)	U.Venta
69097	170,00	41x32	17,0	1

### Placa inducción con regulador

Plaque à induction avec regulateur  
Induktionskochfeld mit regler  
Round induction plate with power control  
Placa de indução com regulador



Ref	€	W	cm	U.Venta
69131	113,90	1000	Ø24x8	1

Placa encastrable. Necesita agujero de Ø216 mm para introducirla.  
Encastable plate. Need a Ø216 mm hole to insert the plate.

### Fuente para chafing dish redondo

Plat rond pour Bain marie rounde  
Einsatz für chafing-dish, rund  
Food pan for round chafing-dish  
travessa para chafing dish redondo



Ref	€	Ø (cm)	U.Venta
69019	59,30	35x7	1

### Aro complemento chafing dish

Support plaque induction  
Zusatzring chafing-dish  
Chafing-dish heater holder  
Aro complemento chafing dish



Ref	€	Ø (cm)	U.Venta
R69100B	19,30	27	1

### Salsera chafing dish

Saucière chafing-dish Luxe  
Sauciere Chafing Dish, Luxe  
Gravy spoon holder  
Molheira chafing dish



Ref	€	cm	h (cm)	L	U.Venta
R69099C	15,90	12x23	4,0	0,40	1

# Colección CHAFING DISH

Inox  
18/10



## Chafing dish GN 1/1 roll top patas latón

Bain marie GN 1/1 roll top pieds en laiton  
Chafing Dish, mit GN-Einsatz, Rolldeckel  
Chafing dish GN 1/1 roll top brass legs  
Chafing dish GN 1/1 roll top patas latão

Ref	€	cm	h (cm)	L	U.Venta
69015	754,30	53x32,5	6,50	9,0	1



## Chafing dish GN 1/1 roll top patas Inox

Bain marie GN 1/1 roll top pieds en inox  
Chafing Dish, mit GN-Einsatz, Rolldeckel  
Chafing dish GN 1/1 roll top st. steel legs  
Chafing dish GN 1/1 roll top patas inox

Ref	€	cm	h (cm)	L	U.Venta
69034	676,80	53x32,5	6,50	9,0	1



## Chafing dish roll top GN 1/1

Bain marie roll top GN 1/1  
Chafing Dish, mit GN-Einsatz 1/1, Rolldeckel  
Chafing dish roll GN 1/1  
Chafing dish roll top GN 1/1

Ref	€	cm	h (cm)	L	U.Venta
69001	699,70	53x32,5	6,50	9,0	1



## Chafing dish BASIC GN1/1 con tapa

Bain marie BASIC GN 1/1 avec couvercle en inox  
Chafing Dish, BASIC, mit GN-Einsatz 1/1 mit Deckel, Rostfrei  
BASIC Chafing Dish GN 1/1 with st. steel lid  
Chafing Dish BASIC GN 1/1 com tampa en .

Ref	€	cm	h (cm)	L	U.Venta
69110	107,10	56x35	28,0	8,5	1

96°C  
max



Adapt. a Ref  
69015 - 69001 - 69004 - 69110

## Calentador eléctrico para chafing

Corp de chauffe pour bain marie  
Elektro-Heizung für Chafing Dish  
Electric heating unit for chafing dish  
Aquecedor eléctrico para chafing dish

Ref	€	W	U.Venta
-----	---	---	---------

A 69002 185,60 700 1

B 69012 214,70 700 1

Con regulador - With regulator

92°C  
max



# CHAFING DISH eléctrico



**Cubeta GN 1/1 en inox (h=65 mm / 8,50 L)**  
GN 1/1 st steel container (h=65 mm / 8,5 L)

Tapa y cubeta en inox incluidas  
Stainless steel lid and bucket included



- Ideal para el sector de la hostelería, restauración y catering.
- Mantiene la temperatura de los alimentos.
- Más seguro al carecer de llama de los geles.
- Tapa y cubeta extraíble GN 1/1 h=65 mm (8,50 L) fabricados en acero inoxidable de alta calidad. Cuerpo fabricado en polipropileno.
- Termostato regulable (85°C +/-10°C).
- Interruptor de encendido y apagado. Indicador luminoso.
- Protección contra sobrecalentamiento.
- Fácil de transportar gracias a sus asas laterales.
- 6 pies antideslizantes y resistentes para mantener la estabilidad.

- Parfait pour le secteur hôtelier, la restauration et le traiteur.
- Conserve la température des aliments.
- Plus sûr parce qu'il n'y a pas de flamme des gels.
- Couvercle et bac amovible GN 1/1 h=65 mm (8,50 L) en acier inoxydable de haute qualité. Corps fabriqué en polypropylène.
- Thermostat réglable (85 °C +/- 10 °C).
- Interrupteur marche/arrêt. Indicateur lumineux.
- Protection contre les surchauffes.
- Facile à transporter grâce à ses poignées latérales.
- 6 pieds antidérapants et résistants pour maintenir la stabilité

- Ideal für Hotel- und Gaststättengewerbe und Catering.
- Temperatur der Nahrungsmittel bleibt erhalten.
- Sicherer ohne Brennpaste/Brenngel.
- Abnehmbarer Deckel und Speiseeinsatz aus hochwertigem Edelstahl (GN 1/1 h=65 mm (8,50 l)). Mit Gestell aus Polypropylen.
- Einstellbares Thermostat ( 85 °C +/-10 °C).
- Mit Ein- und Ausschalter. Kontrollleuchte.
- Schutz vor Überhitzung.
- Einfach an Seitengriffen zu tragen.
- 6 widerstandsfähige Anti-Rutschfüße für festen Stand.

- Ideal for the hospitality, restaurant and catering sectors.
- Maintains temperature of food.
- Safer than chafing dishes that use gel fuels.
- Removable lid and tray GN 1/1 h=65 mm (8.5 L) manufactured in high-quality stainless steel. Body manufactured in polypropylene.
- Adjustable thermostat (85°C +/-10°C).
- On / Off switch. Light indicator.
- Overheating protection.
- Easily portable using the side handles.
- 6 non-slip resistant bases to ensure stability.

- Ideal para o setor da hotelaria, restauração e catering.
- Mantém a temperatura dos alimentos.
- Mais seguro, ao não utilizar géis com chama.
- Tampa e cuvette extraível de aço GN 1/1 h= 65 mm (8,50 L) de aço inoxidável de alta qualidade. Corpo fabricado em polipropileno.
- Termóstato regulável (85°C +/-10°C).
- Interruptor de ligar/desligar. Indicador luminoso.
- Proteção contra sobreaquecimento.
- Fácil de transportar, graças às suas asas laterais.
- 6 patas antideslizantes e resistentes, para maior estabilidade.

## Combinaciones posibles de cubetas - Possible tray options

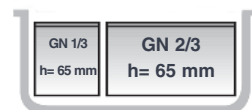
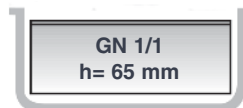

## Chafing dish eléctrico

Chafing dish électrique  
Elektrische Chafing Dish  
Electric Chafing dish  
Chafing dish eléctrico

Ref	€	W	U.Venta
69336	178,10	900	1

Ref	Tensión/Voltage	Potencia/Power	Capacidad/Capacity	Temperatura/Temp.	Cubeta/Container	Dimensiones/Sizes	Peso/Weight
69336	220-240 V / 50-60 Hz	900 W	8,50 L	85°C (+/-10°C)	1GN 1/1 h=65 mm	55x34,5x25 cm	3,90 Kg

# SERVIDOR · CALENTADOR de líquidos

Inox  
18/10

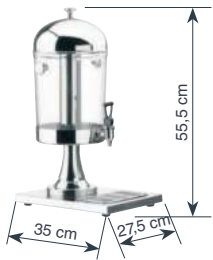

## Servidor de zumos pie cromado

Distributeur de jus en inox  
Saftbehälter mit rostfreiem Fuss  
Juice dispenser mirror stand  
Distribuidor de sumos pé cromado

	Ref	€	L	U.Venta	
	69027	331,80	8,70	1	
<b>A</b>	R69018	28,80	-	1	<b>Grifo</b> · Tap
<b>B</b>	R69027	94,90	8,70	1	<b>Contenedor</b> · Container

## Calentador de líquidos BUFFET

Chauffe-café  
Getränkbehalter  
Coffee urn  
Aquecedor de líquidos

	Ref	€	L	U.Venta	
	69028	372,70	11,0	1	
<b>A</b>	R69018	28,80	-	1	<b>Grifo</b> · Tap

# Gel COMBUSTIBLE

Inox

## Contenedor de combustible

Porte-brûleur  
Brennpasten-Behälter  
Burner holder  
Recipiente de combustível



Ref	€	Ø (cm)	h (cm)	L (cm)	Asa	U.Venta
69006	23,90	9,0	6,0	7,0		1

- Gel de origen orgánico. No produce emanaciones tóxicas.
- Encendido rápido y combustión silenciosa, limpia, inodora, sin humos y sin cenizas.

- Gel d'origine biologique. Ne produit pas de fumées toxiques.
- Allumage rapide et combustion silencieuse, propre, sans odeur, sans fumée et sans cendres.

- Gel organischen Ursprungs. Erzeugt keine giftigen Dämpfe.
- Schnelle Zündung und leise, saubere, geruchlose, rauch- und aschefreie Verbrennung.

- Organic gel fuel. Does not produce toxic fumes.
- Quick-lighting and quiet-burning, clean, odourless, smokeless and ash-free.

- Gel de origem orgânica. Não produz gases tóxicos.
- Ignição rápida e combustão silenciosa, limpa, inodora, sem fumo e sem cinzas.



## Gel combustible ETANOL

Gel chauffe ETHANOL  
Brennpaste, ETHALKOHOL  
Fuel gel, ETHANOL  
Gel combustível ETANOL



	Ref	€	Kg	Tiempo	U.Venta	
<b>A</b>	71780	4,80	0,08	80 min	1	<b>Set 3 latas</b> · 3 can set
<b>B</b>	69108	2,70	0,225	3 h	72	<b>Lata</b> · Can
<b>C</b>	69107	8,60	0,840	-	1	<b>Botella</b> · Bottle
<b>D</b>	69109	39,40	4,00	-	1	<b>Bidón</b> · Barrel

# Cafetera PERCOLADORA

new



**Fácil sist. de apertura**  
Easy open system



**Marcas de llenado**  
Fill lines



**Filtro microperforado**  
Micro-perforated filter



**Sist. dispensador cómodo**  
Convenient dispensing system



## Cafetera percoladora

Percolateur à café  
Kaffee-Perkolator  
Coffee percolator  
Máquina/Percolador de café

Ref	€	W	L	U.Venta
69486	162,90	1500	6	1
69481	181,70	1500	10	1

Ref	Tensión/Voltage	Potencia/Power	Volumen/Volume	Capacidad/Capacity	Dimensiones/Sizes	Peso/Weight
69486	220-240 V; 50 Hz	1500 W	6 L	4,8 L (max)	28x28x40 cm	2,20 Kg
69481	220-240 V; 50 Hz	1500 W	10 L	8,2 L (max)	35x35x45 cm	2,80 Kg

- Fabricada en acero inoxidable de gran calidad.
- Ideal para cafeterías, restaurantes, bares, servicios de buffet y estaciones self-service.
- 2 sistemas de calentamiento independientes para la función de infusión y la función de conservación del calor.
- Distribución de calor rápida y homogénea.
- Mantiene el café a la temperatura óptima salvaguardando sus propiedades de sabor y aroma durante horas.
- Filtro de malla microperforada de acero inoxidable, especialmente diseñado para evitar la generación de posos.
- Luz indicadora de preparación. Indicador del nivel de agua. Bandeja antigoteo.
- Tapa con cierre de seguridad mediante botón de bloqueo.
- Sistema de protección contra el calentamiento en vacío.
- Opción de flujo continuo para una máxima comodidad.
- Tapa, filtro y tubo percolador aptos para el lavavajillas.

- Fabriquée en acier inoxydable de grande qualité.
- Idéal pour les cafétérias, restaurants, bars, services de buffet et espaces de self-service.
- 2 systèmes de chauffe indépendants pour la fonction d'infusion et la fonction de maintien au chaud.
- Distribution de chaleur rapide et homogène.
- Maintient le café à la température optimale en conservant ses propriétés gustatives et aromatiques pendant des heures.
- Filtre en maille micro-perforée en acier inoxydable, spécialement conçu pour éviter la formation de marc.
- Indicateur lumineux de préparation. Indicateur de niveau d'eau. Plateau anti-gouttes.
- Couvercle avec fermeture de sécurité via bouton de blocage.
- Système de protection contre la chauffe à vide.
- Option de flux continu pour un confort maximum.
- Le couvercle, le filtre et le tuyau percolateur peuvent aller au lave-vaisselle.

- Aus hochwertigem Edelstahl.
- Ideal für Cafeterias, Restaurants, Bars, Buffets und Selbstbedienung.
- Ein System zum Aufheizen und ein System zum Warmhalten (von einander unabhängig).
- Schnelle und gleichmäßige Wärmeverteilung.
- Optimaler Erhalt von Temperatur, Aroma und Geschmack des Kaffees über mehrere Stunden.
- Kein Bodensatz dank mikroperforiertem Spaltfilter aus Edelstahl.
- Anzeigeluchte für Brühvorgang. Wasserstandsanzeige. Abtropfschale.
- Verschluss mit Sicherheitssperre.
- Leerlaufschutz.
- Ununterbrochener Fluss für max. Bedienkomfort möglich.
- Deckel, Filter und Perkolatorschlauch spülmaschinenfest.

- Made of high quality stainless steel.
- Perfect for cafés, restaurants, bars, buffet services and self-serve stations.
- Two independent heating systems for the infusion function and the heat preservation system.
- Fast and even heat distribution.
- Keeps coffee at the perfect temperature so it can retain its flavour and aroma for many hours.
- Stainless steel micro-perforated filter specially designed to prevent build-up.
- In-use indicator light. Water level indicator. Anti-drip tray.
- Lid with lock button activated safety lock.
- System to protect against heating while empty.
- Continuous flow option for maximum convenience.
- The lid, filter and percolator tube are dishwasher safe.

- Fabricada em aço inoxidável de grande qualidade.
- Ideal para cafeterias, restaurantes, bares, serviços de buffet e de self-service.
- 2 sistemas de aquecimento independentes para as funções de infusão e de conservação do calor.
- Distribuição do calor rápida e homogénea.
- Mantém o café à temperatura ideal, conservando as suas propriedades de sabor e aroma durante horas.
- Filtro de rede microperforada de aço inoxidável, especialmente concebido para evitar a acumulação de borras de café. Indicador luminoso de preparação.
- Indicador do nível de água. Bandeja antigotejamento.
- Tapa com fecho de segurança e botão de bloqueio.
- Sistema de proteção contra o aquecimento sem água.
- Opção de fluxo contínuo para maior comodidade.
- A tampa, o filtro e o tubo percolador são aptos para máquinas de lavar louça.

# AIRPOT

Inox  
18/10



**NO UTILIZAR CON BEBIDAS GASEOSAS, CALDOS NI LÁCTEOS**  
DO NOT USE WITH FIZZY DRINKS, BROTHS OR DAIRY

**Asas laterales aislantes del calor**  
Side mounted insulated handles

**Ideal para agua, café y té**  
Perfect for water, coffee and tea

**Fabricado en acero inoxidable resistente y de alta calidad**  
Made of strong high quality stainless steel



**Fácil sist. de apertura**  
Easy open system



**Nivel de indicador de líquido**  
Liquid level indicator



**Sist. dispensador cómodo**  
Convenient dispensing system



**Sensor de temperatura**  
Temperature sensor



**Marcas de llenado**  
Fill lines



**Posibilidad de graduar la temperatura**  
The temperature can be adjusted

## Airpot eléctrico

Électrique Airpot  
Elektrische Getrankenpender  
Electric Airpot  
Airpot eléctrico

Ref	€	L	U.Venta
69472	131,00	4	1
69476	141,60	6	1
69471	154,60	10	1

Ref	Tensión/Voltage	Potencia/Power	Capacidad/Capacity	Temperatura/Temp.	Dimensiones/Sizes	Peso/Weight
69472	220-240 V / 50-60 Hz	1500 W	4 L	60°C - 100°C	28x28x35 cm	1,90 Kg
69476	220-240 V / 50-60 Hz	1500 W	6 L	60°C - 100°C	28x28x40 cm	2,00 Kg
69471	220-240 V / 50-60 Hz	1500 W	10 L	60°C - 100°C	28x28x48 cm	2,20 Kg

### Doble pared

Double wall



### Boca ancha para cubitos hielo

Wide mouth for ice cubes



- Mantiene las bebidas calientes o frías durante 24 horas.
- Doble pared que proporciona un alto rendimiento térmico.
- Ligero e irrompible.
- Boca ancha para cubos de hielo.
- Fácil de abrir y cerrar. Fácil limpieza.

- Maintient les boissons chaudes ou froides pendant 24 heures.
- Double paroi qui confère un haut rendement thermique.
- Léger et incassable.
- Bec large pour glaçons.
- Ouverture et fermeture faciles. Facile a nettoyer.

- Hält die Getränke 24 Stunden warm oder kalt.
- Doppelwandig für hohe Wärmeleistung.
- Leicht und unzerbrechlich.
- Breite Öffnung für Eiswürfel.
- Einfach zu öffnen und zu schließen. Facile a nettoyer.

- Keeps drinks hot or cold for 24 hours.
- Double wall that provides high thermal performance.
- Light and shatterproof.
- Wide mouth for ice cubes.
- Easy to open and close. Facile a nettoyer.

- Mantém as bebidas quentes e frias durante 24 horas.
- Parede dupla, que proporciona um elevado rendimento térmico.
- Leve e inquebrável.
- Abertura larga para cubos de gelo.
- Fácil de abrir e fechar. Fácil de limpar.

Inox  
18/10



## Air pot

Air pot  
Getränkenspender, isoliert  
Air pot  
Air pot

Ref	€	L	h (cm)	U.Venta
62472	69,60	2,50	32,5	1
62473	75,50	3,00	34,5	1
62475	101,20	4,00	39,0	1

# Jarra INFUSORA



**Tapa antiderrames**  
Non-spill lid

**Filtro infusor en el centro para frutas y verduras**  
Infusion filter in the centre for fruits and vegetables



## Jarra infusora

Pichet infuseur  
Tee-Zubereiter  
Infusion pitcher  
Jarra infusionadora

Ref	€	cm	L	U.Venta
61954	30,80	19x16x29	2,40	1

**Ideal para preparar bebidas de frutas 100% naturales**  
Ideal for preparing 100% natural fruit drinks



**Desenroscar la tapa girándola en sentido antihorario.**  
Dévisser le couvercle dans le sens inverse des aiguilles d'une montre.  
Deckel im Gegenuhzeigersinn abschrauben.  
Unscrew the lid by turning it counter-clockwise.  
Desenroscar a tampa girando-a no sentido anti-horário.



**Introducir la fruta, hierbas o semillas.**  
Mettre de fruit, les herbes ou les graines.  
Geschnittenes Obst, Kräuter oder Samen hinein geben.  
Introduce the fruit, herbs or seeds.  
Introduzir a fruta, ervas ou sementes.



**Enroscar la tapa girándola en sentido horario.**  
Revisser le couvercle en le faisant tourner dans le sens des aiguilles d'une montre.  
Deckel im Uhrzeigersinn einschrauben.  
Screw on the lid by turning it clockwise.  
Enroscar a tampa girando-a no sentido horário.



**Introducir el filtro dentro de la jarra y presionar la tapa hasta cerrarla.**  
Introduire le filtre dans le pichet et appuyer sur le couvercle jusqu'à sa fermeture.  
Filter in das Gefäß einführen und Deckel zum Schließen herunter drücken.  
Put the filter in the pitcher and push the lid until it's closed.  
Introduzir o filtro no interior da jarra, e pressionar a tampa até fechá-la.

# ORGANIZADOR de café



## Organizador de café

Organisateur de café  
Kaffee Veranstalter  
Coffee organizer  
Organizador de café

	Ref	€	cm	h (cm)	U.Venta
<b>A</b>	62280	10,40	11,5x11,5	20	1
<b>B</b>	62281	37,90	35,5x26,5	18	1
<b>C</b>	62283	69,10	35,5x26,5	31	1

Conjunto · Set

- **Todo lo que necesitas para preparar un café. Todo en un solo lugar.**
- **Cuenta con varios compartimentos, en los que podrás guardar vasos, azúcar, cápsulas, servilletas, etc.**
- Tout ce dont vous avez besoin pour préparer un café. Tout en un seul endroit.
- Il dispose de plusieurs compartiments, dans lesquels vous pouvez stocker du des verres, sucre, des capsules, des serviettes, etc.
- Alles was Sie brauchen, um einen Kaffee zu machen. Alles an einem Ort.
- Es hat mehrere Fächer, in denen Sie Gläser, Zucker, Kapseln, Servietten, usw.
- Everything you need to make a coffee. All in one place
- It has several compartments, in which you can store glasses, sugar, capsules, napkins, etc.
- Tudo que você precisa para fazer um café. Tudo em um só lugar.
- Possui vários compartimentos, nos quais pode guardar copos, açúcar, cápsulas, guardanapos, etc.





# DISPENSADORES de cereales

Inox



ABS

plastic

Tapa/Lid

PS

Polystyrene

Container

TPR

Ruleta

Roulette



- Ideal para diversos tipos de alimentos como cereales, copos de avena, copos de maíz, pasta, café, frutos secos, etc.
- Higiénico y con gran capacidad de almacenamiento.
- Montaje en la pared, aprovecha el espacio de tu mostrador o encimera (62541-62542).

- Idéal pour différents types d'aliments tels que les céréales, les flocons d'avoine, les copeaux de maïs, les pâtes, le café, les fruits secs, etc.
- Hygiénique et offrant une grande capacité.
- Montage sur le mur, gain d'espace sur le comptoir ou le plan de travail (62541-62542).

- Ideal für Frühstücksflocken, Haferflocken, Corn Flakes, Pasta, Kaffee, Dörrobst und andere Arten von Lebensmitteln.
- Hygienisch und mit großem Fassungsvermögen.
- Wandmontage – für mehr Platz auf Küchentheke oder Arbeitsfläche (62541-62542).

- Ideal for various types of foods such as cereals, oatmeal, cornflakes, pasta, coffee, nuts, etc.
- Hygienic and with a large storage capacity.
- Wall mounted so you can make the most of your countertop or worktop space (62541-62542).

- Ideal para diversos tipos de alimentos, como: cereais, flocos de aveia, flocos de milho, pasta, café, frutos secos, etc.
- Higiênico e com grande capacidade de armazenamento.
- Montagem na parede, para aproveitar o espaço do escaparate ou balcão (62541-62542).



**Conserva la frescura y el sabor de los alimentos por más tiempo**  
Preserves the freshness and taste of food for longer

**Sistema dispensador giratorio**  
Rotating dispensing system



**Base ancha; ofrece una mayor estabilidad**  
Wide base for greater stability

## Dispensador de cereales

Distributeur de céréales  
Cerealienspender  
Cereal dispenser  
Dispensador de cereais

Ref	€	cm	h (cm)	L	U.Venta
62545	24,00	16x20	40	3,50	1

**Tapa hermética**  
Lid hermetic

**Anclaje en pared**  
Wall anchor



**Sist. dispensador giratorio**  
Rotating dispensing system

## Dispensador de cereales de pared

Distributeur de céréales mural  
Wandspender für Cerealien  
Wall-mounted cereal dispenser  
Dispensador de cereais de parede

Ref	€	cm	h (cm)	L	U.Venta
62541	16,40	14,5x12,5	31	1,50	1 Simple
62542	27,30	28x12,5	31	1,50 x 2	1 <b>Doble</b> · Double



**Conserva la frescura y el sabor de los alimentos por más tiempo**

Conserve la fraîcheur et le goût des aliments plus longtemps  
 Sorgt für länger anhaltenden Geschmack und Frische der Nahrungsmittel  
 Preserves the freshness and taste of food for longer  
 Conserva a frescura e o sabor dos alimentos durante mais tempo

**Sistema dispensador giratorio**  
 Rotating dispensing system



**Tapa hermética**  
 Lid hermetic

**Base ancha; ofrece una mayor estabilidad**  
 Wide base for greater stability

**Dispensador de cereales DUAL**

Distributeur de céréales  
 Frühstücksflocken Spender  
 Cereal dispenser  
 Dispensador de cereais

Ref	€	L	U.Venta
62596	28,90	2 x 2	1
62597	37,20	3,5 x 2	1

**B**



**A**



**Inox 18/10**

**Dispensador de cereales con base**

Distributeur de Cereales sur Pied  
 Cerialenspender mit Fuß  
 Cereal Dispenser with Stand  
 Distribuidor de cereis com base

	Ref	€	Ø (cm)	cm	L	U.Venta
<b>A</b>	69022	294,30	18,5	24x34x70	10,0	1
<b>B</b>	69023	582,80	18,5	44x34x70	10,0	1

**Permite su uso tanto para calentamiento como para refrigeración**  
 Allows its use for both heating and cooling

**Fabricado en acero inoxidable 18/10**  
 Made of 18/10 stainless steel

**Grifo dispensador**  
 Dispensing tap



**Inox 18/10**

**Dispensador de leche**

Dispensateur de lait  
 Milchkanne mit Fuß  
 Milk dispenser with base  
 Distribuidor de leite

	Ref	€	cm	L	U.Venta
	69030	412,30	22x33x44	5,5	1

# Colección PANERAS · FRUTEROS



- Fabricadas en fibra virgen natural.
- Material ecológico y respetuoso con el medio ambiente.
- Lavables, resistentes y duraderas.
- Diseñadas y fabricadas en España.
- Hechas a mano.
- Tacto agradable y suave, similar a la piel. Espesor 0,55 mm.

- Fabriquéés en fibres vierges naturelles.
- Matériau écologique et respectueux de l'environnement.
- Lavables, résistants et durables.
- Conçues et fabriquéés en Espagne.
- Faites à la main.
- Toucher agréable et doux, similaire au cuir. Épaisseur de 0,55 mm.

- Aus naturreiner Faser.
- Umweltverträgliches Öko-Material.
- Waschbar, robust und langlebig.
- Design und Herstellung in Spanien.
- Handgefertigt.
- Weich und angenehm wie Leder. 0,55 mm dick.

- Made of natural virgin fibre.
- Ecological material respectful with the environment.
- Washable, resistant and durable.
- Designed and manufactured in Spain.
- Handmade.
- Nice soft feel, similar to leather. Thickness 0.55 mm.

- Fabricados em fibra virgem natural.
- Material ecológico, respeitador do meio ambiente.
- Laváveis, resistentes e duráveis.
- Desenhados e fabricados em Espanha.
- Fabricados à mão.
- Tato agradável e suave, similar ao do couro. Espessura 0,55 mm.

A

B

C

D



## Panera KRAFT

Corbeille à pain  
Brotbeute  
Bread basket  
Cesto para o pão

	Ref	€	cm	h max (cm)	h min (cm)	U.Venta
A	63476	13,40	10x10	25	8	1
B	63477	14,30	12x12	25	12	1
C	63478	16,20	15x15	25	12	1
D	63479	18,70	20x20	33	12	1

A

B

C

D



## Panera TEX

Corbeille à pain  
Brotbeute  
Bread basket  
Cesto para o pão

	Ref	€	cm	h max (cm)	h min (cm)	U.Venta
A	63486	13,40	10x10	25	8	1
B	63487	14,30	12x12	25	12	1
C	63488	16,20	15x15	25	12	1
D	63489	18,70	20x20	33	12	1

Inox

### Panera abatible

Paniere rabattable  
Abfallen Brotkorb  
Bread bin foldable lid  
Cestonreclinável



**Mantiene el pan protegido y prolonga su conservación**  
Keeps the bread protected and prolong its conservation



**Puerta abatible**  
Folding door

**Capacidad suficiente para todo tipo de panes**  
Sufficient capacity for all kinds of breads

Ref	€	cm	h (cm)	U.Venta
62944	41,90	44x29	19	1



PP



Polypropilene

Stackable

Dishwasher

BPA free

- Cestas para pan fabricadas en polipropileno. Diseñadas para uso intensivo.
- Estructura de refuerzo de acero inoxidable. Parte trasera más alta que proporciona suficiente de apoyo para panes largos (63492-63493).
- Material con aspecto de mimbre muy resistente, libre de BPA.
- Elaboradas a mano.
- Prácticas e higiénicas. Acabado en mate.
- Ideales para almacenar y exponer panes.
- Apilables.
- Fácil limpieza.

- Paniers pour pain fabriqués en polypropylène. Conçu pour une utilisation intensive.
- Structure renforcée en acier inoxydable. Partie arrière plus haute afin d'offrir un meilleur support aux pains longs (63792-63493).
- Matériau très résistant à l'aspect de rotin, sans BPA.
- Fait à la main.
- Pratiques et hygiéniques. Fini mat.
- Parfaits pour ranger et exposer des pains.
- Empilables.
- Faciles à nettoyer.

- These bread baskets are made of polypropylene. Designed for intensive use.
- Stainless steel reinforcement structure. The taller back gives plenty support for long loaves of bread (63792-63493).
- The very strong material looks like wicker and it's BPA free.
- Handmade.
- They're practical and hygienic. Matte finish.
- Perfect for storing or displaying bread.
- Stackable.
- Easy to clean.

new

**Estructura de refuerzo de acero inoxidable**  
Stainless steel reinforcement structure

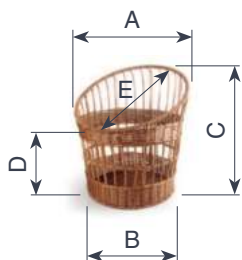

Inox

### Cesta baguette

Corbeille  
Brotkorb  
Basket  
Cesta

A		B							
Ref	€	Ref	€	ØA (cm)	ØB (cm)	C (cm)	D (cm)	E (cm)	U.Venta
63492	62,70	63493	62,70	32,0	28,5	42,0	25,0	36,5	1



### Cesta de pan redonda

Corbeille a pain ronde  
Brotkorb, rund  
Round bread basket  
Cesta de pão redonda

A		B				
Ref	€	Ref	€	Ø (cm)	h (cm)	U.Venta
63471	7,70	63871	7,80	19	8	1
63472	8,60	63872	8,60	21	8	1
63473	9,20	63873	9,20	23	8	1
63474	9,80	63874	9,90	26	8	1

### Cesta de pan oval

Corbeille a pain ovale  
Brotkorb, Oval  
Oval bread basket  
Cesta de pão oval

A		B				
Ref	€	Ref	€	cm	h (cm)	U.Venta
63480	7,00	63880	7,00	19x14	8,0	1
63481	8,30	63881	8,20	24x17	8,0	1
63482	10,10	63882	10,10	28x16	8,5	1



### Cesta de pan

Corbeille a pain  
Brotkorb  
Bread basket  
Cesta de pão

A		B			
Ref	€	Ref	€	Ø (cm)	U.Venta
63494	30,00	63894	29,50	35x20	1



### Cesta de pan cuadrada

Corbeille a pain carré  
Brotkorb, vierekigl  
Square bread basket  
Cesta de pão quadrada

A		B			
Ref	€	Ref	€	cm	U.Venta
63490	34,30	63890	34,00	53x33,5x9	1

**Alambre de acero.**  
**Acabado en negro mate**  
Steel wire.  
Matte black finish

**Ideal para almacenar fruta, pan, verduras, huevos, etc.**  
Can be used for storing fruit, bread, vegetables, eggs, etc.

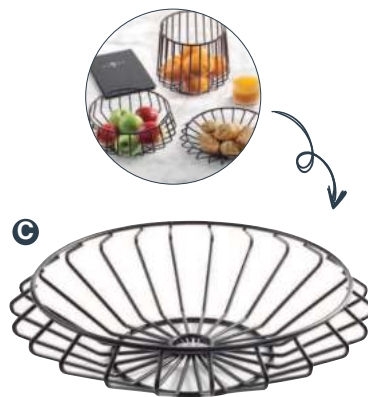

**FE**

Hierro/Iron

### Frutero varillas

Corbeille à fruits  
Obstschale aus Gitterstäben  
Rod fruit bowl  
Cesto de metal para fruta

	Ref	€	Ø (cm)	h (cm)	ØVarilla (mm)	U.Venta
<b>A</b>	61126	22,90	23,4	25,4	4	2
<b>B</b>	61127	20,80	27,0	13,8	4	1
<b>C</b>	61128	22,00	34,0	9,5	4	1

### Frutero varillas

Corbeille à fruits  
Obstschale aus Gitterstäben  
Square fruit bowl  
Cesto de metal para fruta

	Ref	€	Cesta (cm)	h Total (cm)	ØVarilla (mm)	U.Venta
<b>A</b>	61137	34,40	26x26x18,3	27,8	4	1
<b>B</b>	61138	34,40	Ø25,2x17,7	28,9	4	1

**Madera contrachapada color haya**  
Plywood beech color



**Madera**  
**Caucho**

Rubber Wood



### Frutero varillas DUAL

Corbeille à fruits  
Obstschale aus Gitterstäben  
Rod fruit bowl  
Cesto de metal para fruta

Ref	€	Grande (cm)	Peq. (cm)	h (cm)	ØVarilla (mm)	U.Venta
61140	53,40	Ø40x10	Ø24x10	63	4	1

**Madera**  
**Aglomerada**  
**Agglomerate**  
**Wood**



### Frutero varillas redondo bajo

Corbeille à fruits ronde basse  
Obstschale aus Gitterstäben  
Round low rod fruit bowl  
Cesto de metal para fruta redondo baixo

Ref	€	Cesta (cm)	h (cm)	Ø Base (mm)	ØVarilla (mm)	U.Venta
61139	39,70	Ø39x6	7,6	31,3	4	1

**Inox**

### Frutero - panera Inox.

Paniere à fruit et à pain  
Brot-/Obstschale  
Fruits and bread basket.  
Fruteiro-cesto



Ref	€	Ø (cm)	U.Venta
61821	7,50	20	1
61823	11,30	24	1

# Colección CUBERTEROS



**Compartimento hueco**  
Hollow compartment  
11x25x9 cm



## Cubertero GN 1/1

Range-couverts  
Besteckkasten  
Cutlery holder  
Bandeja pata talheres

Ref	€	cm	h (cm)	U.Venta
33121	11,20	52,5x32	9,5	1

**4 compartimentos**  
4 compartments



- Recipiente para cubiertos en color negro de polipropileno.
- Ideal para organizar y guardar los cubiertos e utensilios de la cocina.
- No se deforma con el peso de los cubiertos.
- Cómodo de transportar gracias a sus asas laterales.
- Fondo redondeado para un fácil mantenimiento.
- Apilable.

- Pot à couverts en polypropylène noir.
- Idéal pour organiser et ranger les couverts et les ustensiles de cuisine.
- Il ne se déforme pas avec le poids des couverts.
- Confortable à transporter grâce à ses poignées latérales.
- Fond arrondi pour un entretien facile.
- Empilable.

- Besteckbehälter aus schwarzem Polypropylen.
- Ideal zum Ordnen und Aufbewahren von Besteck und Küchenutensilien.
- Es verformt sich nicht durch das Gewicht des Bestecks.
- Bequemer Transport durch seitliche Griffe.
- Abgerundeter Boden für einfache Wartung.
- Stapelbar.

- Black polypropylene cutlery container.
- Ideal for organizing and storing cutlery and kitchen utensils.
- It does not deform with the weight of the cutlery.
- Comfortable to transport thanks to its side handles.
- Rounded bottom for easy maintenance.
- Stackable.

*new*

- Recipiente para talheres de polipropileno preto.
- Ideal para organizar e guardar talheres e utensílios de cozinha.
- Não deforma com o peso dos talheres.
- Cómodo de transportar graças às suas pegas laterais.
- Fundo arredondado para fácil manutenção.
- Empilhável.



## Cubertero RATTAN PP

Range-couverts  
Besteckkasten  
Cutlery holder  
Bandeja pata talheres

	Ref	€	cm	h (cm)	Comp.	U.Venta
<b>A</b>	63484	8,40	27x10	4,5	1	1
<b>B</b>	63485	8,40	Ø12	15,0	1	1
<b>C</b>	63491	74,80	53x32,5	9,0	4	1

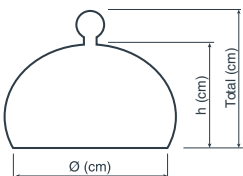

## Campana cubreplatos

Cloche couvre plat  
Tellerlocke  
Plate Cover  
Campânula cobre-pratos



	Ref	€	Ø (cm)	h (cm)	Total (cm)	U.Venta
	61806	39,40	25	14,0	18,5	1
	61809	45,10	29	15,0	20,3	1
	61802	48,80	33	17,0	22,3	1

- Fabricada en vidrio borosilicato de gran calidad y resistente a golpes, altas y bajas temperaturas.
- Protege los alimentos de los factores externos.
- Ideal tanto para conservar como para presentar galletas, bollería, quesos y todo tipo de alimentos.
- Se puede introducir en el microondas, horno y congelador.

- Fabriqué en verre borosilicate de grande qualité et résistante aux chocs ainsi qu'aux basses et hautes températures.
- Protège les aliments des agents externes.
- Idéale aussi bien pour conserver que pour présenter des gâteaux, des viennoiseries, des fromages et tout type d'aliments.
- Peut être mise au micro-ondes, au four ou au congélateur.

- Made of high quality impact resistant borosilicate glass that can withstand high and low temperatures.
- Protects food from external factors.
- Perfect for preserving and presenting biscuits, pastries, cheese or any other kind of food.
- Microwave, oven and freezer safe.

# Tostadoras LONG & DUPLO



- Permite tostar de forma rápida y sencilla, sin necesidad de añadir grasa alguna.
- Función de descongelación y cancelación.
- Regulador ajustable de tueste; elige entre 7 niveles para tostar a tu gusto.
- Ranura alargada para rebanadas extra largas o para más de una rebanada de pan.
- Parrilla adicional para calentar bollos o pan (69360).
- Incorpora una práctica bandeja, donde se depositan las migas.

Permet de griller de façon rapide et simple sans nécessité d'ajouter aucune graisse. Fonction de décongélation et d'arrêt. Régulateur de brunissage réglable : choisissez parmi 7 niveaux pour griller selon vos souhaits. Rainure allongée pour des tranches extra larges ou pour plus d'une tranche de pain. Grille supplémentaire pour réchauffer des viennoiseries ou du pain (69360). Intègre un plateau pratique sur lequel se déposent les miettes.

Für einfaches und schnelles Toasten ohne Fett. Mit Auftau- und Abbruchtaste. Einstellbarer Regler mit 7 Bräunungsstufen ganz nach dem eigenen Geschmack. Extra lange Röstkammer für eine große oder mehrere kleine Brötscheiben. Zusätzliches Rost zum Erwärmen von Brötchen oder Brot (69360). Mit praktischer Krumenwanne.

- Fast and easy toasting without the need to use any fatty products.
- Defrost and cancel functions.
- Adjustable darkness regulator. Choose from 7 levels for toasting as you like.
- Long slot for extra wide slices of bread or more than one slice of bread at once.
- Additional grill to heat buns or bread (69360).
- It has a practical tray for catching crumbs.

- Permite tostar de forma rápida e fácil, sem necessidade de acrescentar nenhum tipo de gordura.
- Função de descongelação e botão de cancelamento.
- Regulador de tostagem com 7 níveis diferentes, para o ajustar ao gosto pessoal.
- Ranhura longa para fatias extra longas, ou para mais do que uma fatia de pão.
- Grelha adicional para aquecer bolos ou pão (69360).
- Incorpora uma prática bandeja para recolher as migalhas.



**Termostato**  
7 posiciones de tostado  
Thermostat: 7 positions toasted



**Dispone de función descongelar**  
It has a defrost function



**Bandeja recogemigas**  
Crumb tray



**Patas de apoyo antideslizantes**  
Non-slip supports



**Ranura alargada de 25 x 4 cm**  
25 x 4 cm slot for extra wide slices



**Doble ranura**  
Double slot

**Ranura alargada de 24,5 x 4 cm**  
24,5 x 4 cm slot for extra wide slices



**Doble ranura**  
Double slot

Inox

## Tostadora LONG

Grille-pain  
Toaster  
Toaster  
Torradeira

Ref	€	W	U.Venta
69260	61,80	1500	1

Inox  
18/10

## Tostadora DUPLO

Grille-pain  
Toaster  
Toaster  
Torradeira

Ref	€	W	U.Venta
69360	63,70	1000	1

Ref	Tensión/Voltage	Potencia/Power	Selector/Selector	Dimensiones/Sizes	Peso/Weight
69260	220-240 V; 50/60 Hz	1500 W	<b>Dos ranuras</b> · Two slots	39x15,2x20,5 cm	2,40 Kg
69360	220-240 V; 50/60 Hz	1000 W	<b>Una ranura</b> · One slot	41x12x18,5 cm	1,40 Kg



# Tostadoras **BUFFET**



**Tostado continuo de pan**  
Continuous bread toasting

**Doble sistema de calentamiento**  
Dual heating system

**Cinta transportadora**  
Conveyor belt



## Tostadora de cinta transportadora

Toasteur professionnel  
Durchlauftoaster  
Conveyor toaster  
Torradeira de tapete rolante

Ref	€	W	U.Venta
69065	835,90	1340	1
69066	964,10	2240	1

Ref	Tensión/Voltage	Potencia/Power	Velocidad/Speed	Producción/Product.	Dimensiones/Sizes	Peso/Weight
69065	220-240 V; 50 Hz	1340 W	0,46 - 0,73 m/min.	150 h	53x37x40 cm	12,85 Kg
69066	220-240 V; 50 Hz	2240 W	0,46 - 0,73 m/min.	300 h	53x45x40 cm	15,50 Kg



**Bandeja recogemigas**  
Crumbs tray

**Hueco útil entre parrillas 5,5 cm**  
Usable gap between racks 5.5 cm

**Calentamiento infrarrojos Lámparas infrarrojas halógenas de cuarzo**  
Infrared heating Quartz halogen infrared lamps



## Tostador horizontal

Grille-pain horizontal  
Toaster horizontal  
Horizontal toaster  
Torradeira horizontal

Ref	€	W	U.Venta
<b>A</b> 69172	354,30	2400	1
<b>B</b> 69173	418,80	3150	1

Ref	Tensión/Voltage	Potencia/Power	Lámp./Lamps	Parrilla/Grill	Dimensiones/Sizes	Peso/Weight
69172	220-240 V; 50/60 Hz	2400 W	6 (3 + 3)	40x24 cm	50x25x28 cm	7,10 Kg
69173	220-240 V; 50/60 Hz	3150 W	9 (3 + 3 + 3)	40x24 cm	50x25x38cm	9,20 Kg



**Ranuras de grandes dimensiones**  
Huge slots for toasting



**Bandeja recogemigas**  
Crumbs tray

## Tostadora buffet Inox 4-6 ranuras

Grille-pain buffet pour 4-6 tranches  
Buffet-Toaster für 4-6 Brotscheiben  
4-6 slots st steel buffet toaster  
Torradeira buffet 4-6 fatias de pão

Ref	€	Ranuras	U.Venta
<b>A</b> 69294	230,70	4	1
<b>B</b> 69296	306,40	6	1

Ref	Tensión/Voltage	Potencia/Power	Selector/Selector	Ranuras/Slots	Dimensiones/Sizes	Peso/Weight
69294	220-240 V; 50/60 Hz	1800 W	2-4 ranuras - 2-4 groves	15x3 cm	29x26x22 cm	3,90 Kg
69296	220-240 V; 50/60 Hz	2500 W	2-4-6 ranuras - 2-4-6 groves	15x3 cm	42x26x22 cm	5,00 Kg

**A** **Inox**  
**18/10**



**B**



- Gracias a su diseño y área de calentamiento podrá tostar todo tipo de panes o bollería y varias rebanadas a la vez.
- Grâce à sa conception et sa zone de chauffe, vous pourrez griller tout type de pains ou de viennoiseries et plusieurs tranches à la fois.
- Dank des Designs und des Erwärmungsbereichs können Sie alle möglichen Brotsorten und mehrere Scheiben gleichzeitig tosten.
- Thanks to its design and heating area you will be able to toast all types of bread and pastries, and several slices at a time.
- Graças ao seu desenho e área de aquecimento, poderá tostar todo o tipo de pães ou bolos, e várias fatias ao mesmo tempo.



**6 posiciones de calentamiento**  
6 heating positions



**Aviso sonoro**  
Alarm



**Bandeja recogemigas**  
Crumbs tray

## Tostadora horizontal

Toaster horizontal  
Horizontal-/Toaster  
Electric toaster  
Torradeira horizontal

	Ref	€	W	U.Venta
<b>A</b>	69163	33,00	600	1 BASIC
<b>B</b>	69363	41,30	600	1 EASY

Ref	Tensión/Voltage	Potencia/Power	Temperatura/Temp.	Tostado/Toasted	Parrilla/Grill	Dimensiones/Sizes	Peso/Weight
69163	220-240 V; 50/60 Hz	600 W	360°C	6	25x20 cm	36x21x6,5 cm	1,00 Kg
69363	220-240 V; 50/60 Hz	600 W	360°C	6	25x20 cm	42x30x9 cm	1,00 Kg

## Placa vitrocerámica ENERGY



**Superficie de calentamiento**  
Heating surface

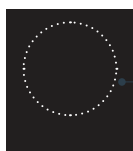

- Placa vitrocerámica rápida, eficaz, segura, fiable y de gran capacidad de calentamiento.
- Su diseño portátil y compacto resulta ideal para su uso en cualquier lugar.
- Área de cocción de 10 cm / 20 cm de diámetro.
- Botones táctiles, intuitivos y fáciles de utilizar con un toque suave.
- Indicadores luminosos.
- Dispone de función de bloqueo de seguridad para niños.
- Regulable en potencia y temperatura.
- Temporizador de 240 minutos con avisador acústico y auto desconexión.

- Plaque vitrocéramique rapide, efficace, sûre, fiable et d'une grande capacité de chauffe.
- Sa conception portable et compacte est idéale pour une utilisation n'importe où.
- Zone de cuisson de 10 cm / 20 cm de diamètre.
- Boutons tactiles, intuitifs et faciles à utiliser avec un toucher doux.
- Indicateurs lumineux.
- Dispose d'une fonction de blocage de sécurité pour les enfants.
- Réglable en puissance et en température.
- Minuteur de 240 minutes avec alerte sonore et arrêt automatique.

## Placa vitrocerámica ENERGY

Plaque vitrocéramique  
Keramikkochfeld  
Ceramic hob  
Placa vitrocerámica

Ref	€	W	U.Venta
69232	112,30	2000	1

- Fast, efficient, safe, reliable ceramic hob with high heating capacity.
- Its portable and compact design is ideal for use anywhere.
- 10 cm / 20 cm diameter cooking area.
- Intuitive and easy to use soft touch buttons.
- Luminous indicators.
- Includes a child safety lock function.
- Adjustable power and temperature.
- 240-minute timer with audible warning and auto-off.

Ref	Tensión/Voltage	Potencia/Power	Temperatura/Temp.	Temporizador/Timer	Ø cocción/Cooking	Dimensiones/Sizes	Peso/Weight
69232	220-240 V; 50/60 Hz	2000 W (8 levels)	60°C - 600°C (8 levels)	0 - 240 min (8 levels)	10 cm / 20 cm	39x32x5,5 cm	2,60 Kg

# Placas de INDUCCIÓN



- Placas de inducción rápidas, eficaces, seguras, fiables y de gran capacidad de calentamiento.
- Sus diseños portátiles y compactos resultan ideales para su uso en cualquier lugar.
- Botones táctiles, intuitivos y fáciles de utilizar con un toque suave.
- Dispone de función de bloqueo de seguridad para niños.
- 40% ahorro de tiempo y energía respecto a otras placas convencionales.

- Plaque à induction rapide, efficace, sûre, fiable et d'une grande capacité de chauffe.
- Sa conception portable et compacte est idéale pour une utilisation n'importe où.
- Boutons tactiles, intuitifs et faciles à utiliser avec un toucher doux.
- Dispose d'une fonction de blocage de sécurité pour les enfants.
- 40% de gain de temps et d'économies d'énergies par rapport à d'autres plaques conventionnelles.

- Schnelles, sicheres, zuverlässiges Induktionskochfeld mit hervorragender Heizleistung.
- Aufgrund seines tragbaren und kompakten Designs ist es überall einsetzbar.
- Intuitive, bedienerfreundliche Soft-Touch-Tastfelder.
- Kindersicherungsfunktion.
- 40 % Zeit- und Energieersparnis verglichen mit anderen herkömmlichen Kochfeldern.

- Fast, efficient, safe, reliable induction hob with high heating capacity.
- Its portable and compact design is ideal for use anywhere.
- Intuitive and easy to use soft touch buttons.
- Includes a child safety lock function.
- 40% saving in time and energy compared to other conventional hobs.

- Placa de indução rápida, eficaz, segura, fiável e de grande potência.
- O seu design portátil e compacto permite a sua utilização em qualquer lugar.
- Botões tácteis, intuitivos e fáceis de utilizar, com um suave toque.
- Função de bloqueio de segurança à prova de crianças.
- Poupança de 40% em tempo e energia, em comparação com as placas convencionais.

Superficie de calentamiento  
Heating surface



Superficie de calentamiento  
Heating surface



## IPX3

proof

### Placa inducción profesional CHEF

Plaque induction professionnelle  
Profi-Induktionsplatte  
Professional induction cooktop  
Placa de indução profissional

Ref	€	W	U.Venta
69132	431,40	3500	1

### Placa inducción profesional ROCA

Plaque induction professionnelle  
Profi-Induktionsplatte  
Professional induction cooktop  
Placa de indução profissional

Ref	€	W	U.Venta
69337	364,70	2700	1

Ref	Tensión/Voltage	Potencia/Power	Niveles Pot. /P. levels	Temperatura/Temp.	Reloj/Timer	Dimensiones/Sizes	Peso/Weight
69132	220-240 V; 50/60 Hz	3500 W	17	35°C - 240°C	0 - 180 min	34x43x12 cm	7,35 Kg
69337	220-240 V; 50/60 Hz	2700 W	10	60°C - 240°C	0 - 180 min	30x39x10 cm	5,40 Kg

**Superficie de calentamiento**  
Heating surface



Ø12 cm  
min  
Ø28 cm  
max

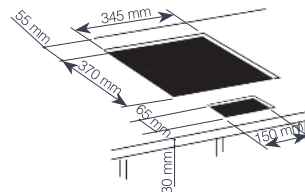

**Posibilidad de encastrar**  
Encastrable option

**Superficie de calentamiento**  
Heating surface



Ø12 cm  
min  
Ø28 cm  
max



**Regulable en potencia**  
Adjustable in power

**Placa inducción profesional EASY**

Plaque Induction Professionnelle  
Profi-Induktionsplatte  
Professional induction cooktop  
Placa de indução Profissional

Ref	€	W	U.Venta
69362	370,10	3500	1

**Placa de inducción PRO**

Table de cuisine à induction  
Induktionskochfeld  
Induction Cooker  
Placa de indução

Ref	€	W	U.Venta
69371	333,90	500/3500	1

Ref	Tensión/Voltage	Potencia/Power	Niveles Pot. /P. levels	Niveles Temp. /T. levels	Dimensiones/Sizes	Peso/Weight
69362	220-240 V; 50/60 Hz	3500 W	10 (500W - 800W - 1100W - 1500W - 1800W - 2100W - 2500W - 2800W - 3100W - 3500W)	-	34x44,5x12,5 cm	7,00 Kg
69371	220-240 V; 50/60 Hz	500-3500 W	1-10 (500W (1) - 800W (2) - 1100W (3) - 1500W (4) - 1800W (5) - 2100W (6) - 2500W (7) - 2800W (8) - 3100W (9) - 3500W (10))	10 (80C - 80C - 100C - 120C - 140C - 160C - 180C - 200C - 220C - 240C)	36x38x12,5 cm	6,80 Kg

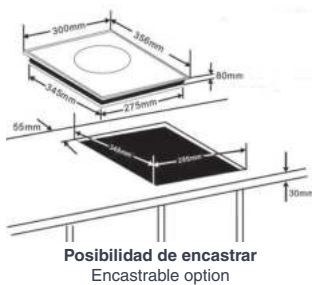

**Posibilidad de encastrar**  
Encastrable option

**Superficie de calentamiento**  
Heating surface

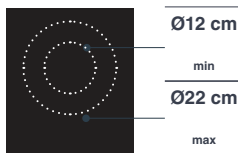

Ø12 cm  
min  
Ø22 cm  
max

**Superficie de calentamiento**  
Heating surface



Ø12 cm  
min  
Ø22 cm  
max



**Placa de inducción EXPERT**

Table de cuisine à induction  
Induktionskochfeld  
Induction Cooker  
Placa de indução

Ref	€	W	U.Venta
69032	279,30	2000	1

**Placa de inducción SLIM**

Table de cuisine à Induktion  
Induktionskochfeld  
Induction cooker  
Placa de indução

Ref	€	W	U.Venta
69332	158,40	2000	1

Ref	Tensión/Voltage	Potencia/Power	Niveles Pot. /P. levels	Reloj/Timer	Dimensiones/Sizes	Peso/Weight
69032	220-240 V; 50/60 Hz	2000 W	6	0 - 180 min	31x36x7,5 cm	2,90 Kg
69332	220-240 V; 50/60 Hz	2000 W	8	0 - 180 min	30x37x4,5 cm	2,67 Kg

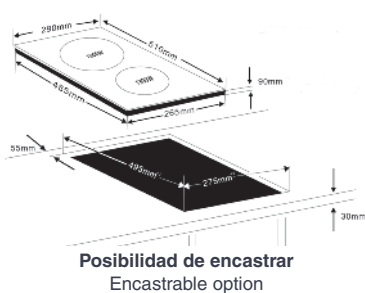

Superficie de calentamiento  
Heating surface



Posibilidad de encastrar  
Encastrable option



Superficie de calentamiento  
Heating surface



Posibilidad de encastrar  
Encastrable option



### Placa inducción DUAL VERTICAL

Plaque induction double  
Induktionskochfeld doppelt  
Double induction cooktop  
Placa de indução dupla

Ref	€	W	U.Venta
69033	457,20	1800+1300	1

### Placa inducción DUAL HORIZONTAL

Plaque induction  
Induktionskochfeld doppelt  
Induction cooktop  
Placa de indução

Ref	€	W	U.Venta
69333	270,20	2000+1500	1

Ref	Tensión/Voltage	Potencia/Power	Niveles Pot. /P. levels	Reloj/Timer	Dimensiones/Sizes	Peso/Weight
69033	220-240 V; 50/60 Hz	1800 +1300 W	8	0 - 99 min	29x51x9 cm	4,50 Kg
69333	220-240 V; 50/60 Hz	2000 W + 1500 W	7	0 - 180 min	60x34x7,5 cm	5,20 Kg

Placa cerámica: Ø26 cm  
Ceramic plate: Ø26 cm



Inox

### Placa inducción wok profesional

Plaque à induction wok professionnelle  
Induktionskochplatte Wok Professional  
Induction cooktop wok professional  
Placa indução wok profissional

Ref	€	U.Venta
69138	448,00	1

- Cuerpo fabricado en 3 capas: acero inoxidable 18/10, aluminio, acero inoxidable 18%.
- La capa exterior, es de acero inoxidable con componentes ferríticos, lo que la convierte totalmente compatible con las cocinas de inducción.
- Los mango fabricado en acero inoxidable 18/10 y recubierto con un protector térmico de silicona

- Body manufactured in a 3-layered: 18/19 stainless steel, aluminium, 18% stainless steel.
- Exterior layer, of stainless steel with ferrite materials, making it completely compatible with induction cookers.
- The grip are made in 18/10 stainless steel and covered in a silicon heat protection.



### Wok Trimetal

Wok Trimetal  
Wok, Trimetal  
Trimetal wok  
Wok Trimetal

Ref	€	Ø (cm)	L
53836	174,40	36	5,50

Ref	Tensión/Voltage	Potencia/Power	Temperatura/Temp	Tiempo/Timer	Dimensiones/Sizes	Peso/Weight
69138	220-240 V; 50/60 Hz	3500 W	60°C - 240°C	0 - 180 min	34x44,5x12,5 cm	7,50 Kg

# Placas de CALENTAMIENTO

Inox  
18/10



## Calentador BUFFET 3x GN 1/3

Chauffe  
Warmer  
Warmer  
Aquecedor

Ref	€	W	U.Venta
69445	99,70	300	1



## Placa calentamiento

Plaque pour Chauffante  
Warmhalteplatte  
Warming Plate  
Placa aquecimento

Ref	€	W	U.Venta
69045	92,50	300	1



## Placa calentamiento Vitrocerámica

Plaque vitrocéramique chaleur  
Glaskeramikkheizplatte  
Hob heating plate  
Placa aquecimento vitrocerâmica

Ref	€	W	U.Venta
69145	204,70	230	1

## Platos y bandejas siempre calientes

Ensures dishes and trays are always warm

- Una solución perfecta para profesionales de hostelería, buffet, eventos, catering, ferias...
- Ideal para mantener los alimentos calientes antes de servirlos en la mesa a una temperatura perfecta.
- Termostato regulable en temperatura.
- Tres contenedores de calentamiento GN 1/3 de 2,5 L con tapas transparentes de policarbonato, ideales para albergar una gran variedad de alimentos.
- Marco soporte de acero inoxidable (Ref.: 69445).
- Puede usarlo como placa de calentamiento para calentar platos y preparados, quitando el soporte y los contenedores (Ref.: 69445).
- Asas aislantes de calor y patas antideslizantes.
- **NO cocinar sobre la misma placa.**

- Une solution parfaite pour les professionnels de l'hôtellerie, buffets, événements, traiteurs, salons, ...
- Idéale pour garder au chaud d'aliments avant de les servir à table à une température parfaite.
- Thermostat réglable en température.
- Trois conteneurs de réchauffage GN 1/3 de 2,5 L avec couvercles transparents en polycarbonate, parfaits pour accueillir une grande variété d'aliments. Cadre support en acier inoxydable (Ref.: 69445).
- Peut être utilisé en tant que plaque pour réchauffer des plats et des préparations culinaires, en retirant le support et les conteneurs (Ref.: 69445).
- Poignées isolantes de la chaleur et pieds antidérapants.
- **NE PAS** cuisiner sur la même plaque.

- Die perfekte Lösung für Gastgewerbe, Buffets, Veranstaltungen, Catering, Messen ...
- Ideal zum Warmhalten von Speisen, bevor sie bei perfekter Temperatur am Tisch serviert werden.
- Thermostat mit Temperaturregelung.
- Drei Heizbehälter GN 1/3 mit einem Volumen von 2,5 l und durchsichtigen Polycarbonat-Decke, ideal zum Aufbewahren vielfältiger Lebensmittel
- Tragrahmen aus Edelstahl (Ref.: 69445).
- Kann bei Entfernen des Halters und der Behälter als Heizplatte zum Erwärmen von Speisen und Fertiggerichten verwendet werden (Ref.: 69445).
- Isolierte Griffe und rutschfeste Füße.
- **NICHT** direkt auf der Platte kochen.

- A perfect solution for hospitality, buffet, events, catering and trade show professionals...
- Ideal for keeping the food warm before serving them at a perfect temperature.
- Temperature-adjustable thermostat.
- Three GN 1/3 2.5 L heating containers with transparent polycarbonate lids, perfect for storing a wide variety of food. Stainless steel support frame (Ref.: 69445).
- It can be used as a heating plate to warm up food or prepared dishes if the support and the containers are taken off (Ref.: 69445).
- Heat-isolating handles and non-slip feet.
- **DO NOT** cook on the same tray.

- Uma solução perfeita para profissionais da hotelaria, buffets, eventos, catering, ferias...
- Ideal para manter quentes os alimentos, para os servir à mesa a uma temperatura perfeita.
- Termostato de temperatura regulável.
- Três recipientes de aquecimento GN 1/3 de 2,5 litros, com tampas transparentes de policarbonato, ideais para armazenar uma grande variedade de alimentos.
- Marco de suporte em aço inoxidável (Ref.: 69445).
- Pode utilizar-se como placa de aquecimento para aquecer pratos e preparados, retirando o suporte e os recipientes (Ref.: 69445).
- Asas isoladoras do calor e patas antideslizantes.
- **NÃO** cozinhar na própria placa

Ref	Tensión/Voltage	Potencia/Power	Contenedor/Container	Temp. máx./ Max. temp.	Placa/Plate	Dimensiones/Sizes	Peso/Weight
69445	220-240 V; 50/60 Hz	300 W	GN 1/3 - 2,5 L (3)	80°C (max)	53x35,8 cm	65x38x15,4 cm	4,20 Kg
69045	220-240 V; 50/60 Hz	300 W	-	80°C (max)	53x35,5 cm	65x38x6,2 cm	2,60 Kg
69145	220-240 V; 50/60 Hz	230 W	-	60°C - 105°C (max)	55x36,5 cm	62x36,5x4,5 cm	4,10 Kg

# CALENTADORES alimentos



- **Mantiene caliente todo tipo de sopas, salsas, consomés y líquidos. Ideal para cantidades grandes.**
- Maintenir au chaud tout type de soupes, sauces, consommés, liquides, etc. Idéal pour de grandes quantités.
- Warmhalten aller Arten von Suppen, Saucen, Konsommees, Flüssigkeiten, usw. Ideal für große Mengen.
- Keep all kinds of soups, sauces, consommés, liquids etc hot. Ideal for large amounts.
- Manter quente todo o tipo de sopas, molhos, consomés, líquidos, etc. Ideal para grandes quantidades.

**A**

**Inox 18/10**



**B**



**C**



## Olla calentador sopa PROFESIONAL

Marmite Buffet chaud  
Suppen-und Speisenwärmer  
Soup kettle  
Panela aquecedora de sopa

	Ref	€	U.Venta	
<b>A</b>	69267	289,90	1	<b>Inox 18/10</b> · 18/10 stainless steel
<b>B</b>	69037	173,90	1	<b>Hierro esmaltado</b> · Enameled iron
<b>C</b>	69038	245,20	1	<b>Inox</b> · St steel
<b>D</b>	69039	58,10	1	<b>Repuesto</b> · Replacement (69037-69038)

**Repuesto para las ref.: 69037-69038**  
Replacement for ref.: 69037-69038

**Contenedor sopa Inox 18/10**  
18/10 St. Steel soup container

**Capacidad: 10 L / Medidas: Ø24x25 cm**  
Capacity: 10 l / Sizes: Ø24x25 cm



Ref	Tensión/Voltage	Potencia/Power	Temperatura/Temp.	Capacidad/Capacity	Dimensiones/Sizes	Peso/Weight
69267	220-240 V; 50/60 Hz	800 W	30°C - 90°C	11,0 L	Ø33x32 cm	4,50 Kg
69037	220-240 V; 50/60 Hz	400 - 475 W	30°C - 90°C	10,0 L	Ø34,5x36 cm	4,50 Kg
69038	220-240 V; 50/60 Hz	400 - 475 W	30°C - 90°C	10,0 L	Ø34,5x36 cm	4,50 Kg

# FUENTES de chocolate



**Inox 18/10**

## Fuente de chocolate

Fontaine chocolat  
Schokoladen Fontäne  
Chocolate fountain  
Fonte chocolate

	Ref	€	Tower	U.Venta
<b>A</b>	69318	60,10	18 cm	1
<b>B</b>	69319	102,20	38 cm	1



**A**



**B**



Ref	Tensión/Voltage	Potencia/Power	Temperatura/Temp.	Capacidad/Capacity	Torre/Tower	Dimensiones/Sizes	Peso/Weight
69318	220-240 V; 50/60 Hz	35 W	40 -50°C	0,50 L (máx)	18 cm (Height)	Ø16x30 cm	1,15 Kg
69319	220-240 V; 50/60 Hz	80 W	40 -50°C	1,80 L (máx)	38 cm (Height)	Ø23x54,5 cm	2,05 Kg

# Calentador **BUFFET**

Inox



- Ideal para grandes cocinas, buffet, catering o comedores.
- Mantiene los platos a temperatura perfecta durante un tiempo prolongado.
- Estructura de acero inoxidable de alta calidad y resistente.
- Placa calentadora de acero inoxidable con regulación de temperatura entre 40°C - 90°C.
- Lámparas halógenas para garantizar una temperatura homogénea con regulación independiente para cada una de ellas.
- Pantalla protectora de plexiglás altamente resistente.

- Idéal pour grandes cuisines, buffets, traiteurs ou cantines.
- Maintient les plats à la température parfaite pendant un laps de temps prolongé.
- Structure en acier inoxydable de grande qualité et résistant.
- Plaque chauffante en acier inoxydable avec réglage de température de 40°C à 90°C.
- Ampoules halogènes pour garantir une température homogène avec réglage indépendant pour chacune d'entre elles.
- Écran de protection en plexiglas hautement résistant.

- Ideal für Großküchen, Buffets, Catering oder Restaurants.
- Hält Speisen über längere Zeit auf perfekter Temperatur.
- Aus hochwertigem und widerstandsfähigem Edelstahl hergestellter Aufbau.
- Heizplatte aus Edelstahl mit Temperaturreglung zwischen 40°C bis 90°C.
- Individuell einstellbare Halogenlampen sorgen für gleich bleibende Temperatur.
- Schutzschirm aus hoch widerstandsfähigem Plexiglas.

- Perfect for large kitchens, buffets, catering or dining rooms.
- It keeps food at the perfect temperature for an extended period.
- Durable high quality stainless steel structure.
- Stainless steel heating plate with adjustable temperature from 40° C to 90° C.
- The halogen lamps guarantee even temperature and each one can be adjusted independently.
- High impact perspex safety screen.

- Ideal para cozinhas grandes, buffets, catering e refeições.
- Mantém os pratos à temperatura perfeita durante um tempo prolongado.
- Estrutura de aço inoxidável de alta qualidade e resistência.
- Placa aquecedora em aço inoxidável com regulação de temperatura entre 40 - 90 °C.
- Lâmpadas de halogéneo para garantir uma temperatura homogénea, com regulação individual e independente.
- Placa protetora de metacrilato, altamente resistente.



**Incluye bombillas infrarrojos (Ref.: R69061A)**  
Includes infrared heating bulbs



## Calentador **BUFFET DUAL**

Plaque électrique  
Warmhalteplatte  
Electric warming plate  
Placa aquecimiento eléctrico

Ref	€	W (Placa)	W (Lámp.)	U.Venta
69562	519,20	500	2x250	1



## Calentador **BUFFET TRIPLE**

Plaque électrique  
Warmhalteplatte  
Electric warming plate  
Placa aquecimiento eléctrico

Ref	€	W (Placa)	W (Lámp.)	U.Venta
69563	684,10	650	3x250	1

Ref	Tensión/Voltage	Pot. Placa/Plate P.	N° Lámp./Lamps	Pot. Lámp./Lamp P.	Temperatura/Temp.	Dimensiones/Sizes	Peso/Weight
69562	220-240 V; 50/60 Hz	500 W	2	250 W	40°C - 90°C	78x53x70 cm	12,5 Kg
69563	220-240 V; 50/60 Hz	650 W	3	250 W	40°C - 90°C	107x53x70 cm	16,5 Kg



# LÁMPARAS de calentamiento

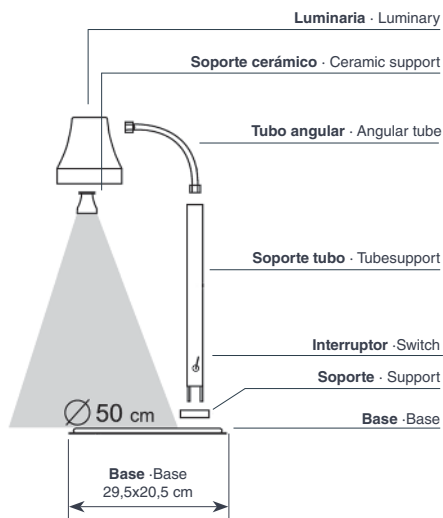

- Para uso profesional en hostelería.
- Mantiene calientes los platos. Calentamiento por infrarrojos.
- Se aconseja mantener la lámpara a 50-60 cm de distancia de los platos.
- Bombilla para todas nuestras lámparas de calentamiento.

- Pour un usage professionnel en hôtellerie.
- Maintient les plats au chaud. Chauffe par infrarouges.
- Il est conseillé de maintenir la lampe à une distance de 50-60 cm des plats.
- Ampoule pour toutes nos lampes chauffantes.

- Für den Einsatz im Gastronomiebereich.
- Hält die Speisen warm. Erwärmung durch Infrarotstrahlen.
- Es wird empfohlen, einen Abstand von 50 bis 60 cm zwischen der Lampe und den Speisen einzuhalten.
- Glühbirne für alle unsere Heizlampen.

- For professional catering use.
- Hält die Speisen warm. Infrared heating.
- It is recommended that the lamp is kept at a distance of 50-60cm from the plates.
- Bulb for all our heating lamps.

- Para uso profissional em hotelaria.
- Mantém os pratos quentes. Aquecimento por infravermelhos.
- É recomendável manter as lâmpadas a uma distância de 50 a 60 cm dos pratos.
- Bulbo para todas as nossas lâmpadas de aquecimento.

**Apta para todas nuestras lámparas de calentamiento**

Suitable for all our heating lamps

## Bombilla infrarrojos

Ampoule infrarouge  
 Infrarot Glühbirne  
 Infrared heating bulb  
 Lampada infravermelho



**Incluye bombillas infrarrojos (Ref.: R69061A)**  
 Includes infrared heating bulbs

Ref	€	W	U.Venta
R69061A	9,80	275	1



**AL**  
 Aluminium

## Lámpara calentamiento infrarrojos

Lampe de chauffage infrarouge  
 Infrarot Wärmelampe  
 Infrared heating lamp  
 Lampara calor infravermelho



**Regulable en altura**  
 Height adjustable

	Ref	€	W	U.Venta
<b>A</b>	69361	105,10	275	1
<b>B</b>	69061	145,40	550	1



**Inox**  
 18/10

## Lámpara de calentamiento infrarrojos

Lampe de chauffage infrarouge  
 Infrarot Wärmelampe  
 Infrared heating lamp  
 Lampara calor infravermelho

	Ref	€	W	U.Venta
<b>A</b>	69263	473,50	275	1
<b>B</b>	69264	615,50	550	1

Ref	Tensión/Voltage	Potencia/Power	Dimensiones/Sizes	Peso/Weight
69361	220-240 V; 50/60 Hz	275 W	34x33x56 -71 cm	1,15 Kg
69061	220-240 V; 50/60 Hz	550 W	36x45x61 - 75 cm	1,58 Kg
69263	220-240 V; 50/60 Hz	275 W	31x23x79 cm	6,0 Kg
69264	220-240 V; 50/60 Hz	550 W	36x36x76 cm	7,0 Kg

# LÁMPARAS de calentamiento extensibles



**Bombilla incluida**  
Lamp included



- Para uso profesional en hostelería.
- Mantiene calientes los platos. Calentamiento por infrarrojos.
- Se aconseja mantener la lámpara a 50-60 cm de distancia de los platos.
- Bombilla para todas nuestras lámparas de calentamiento.

- Pour un usage professionnel en hôtellerie.
- Maintient les plats au chaud. Chauffe par infrarouges.
- Il est conseillé de maintenir la lampe à une distance de 50-60 cm des plats.
- Ampoule pour toutes nos lampes chauffantes.

- Für den Einsatz im Gastronomiebereich.
- Hält die Speisen warm. Erwärmung durch Infrarotstrahlen.
- Es wird empfohlen, einen Abstand von 50 bis 60 cm zwischen der Lampe und den Speisen einzuhalten.
- Glühbirne für alle unsere Heizlampen.

- For professional catering use.
- Keeps the dishes warm. Infrared heating.
- It is recommended that the lamp is kept at a distance of 50-60cm from the plates.
- Bulb for all our heating lamps.

- Para uso profissional em hotelaria.
- Mantém os pratos quentes. Aquecimento por infravermelhos.
- É recomendável manter as lâmpadas a uma distância de 50 a 60 cm dos pratos.
- Bulbo para todas as nossas lâmpadas de aquecimento.



**Incluye bombillas infrarrojos (Ref.: R69061A)**  
Includes infrared heating bulbs



## Lámpara calentamiento infrarrojos cable extensible

Lampe de chauffage infrarouge câble extensible  
Infrarot Wärmelampe Kabel ausziehbar  
Infrared heating lamp extensible  
Lâmpara calor infravermelho cabo extensível

	Ref	€	W	U.Venta	
<b>A</b>	69266	126,70	275	1	Lijado · Sanding
<b>B</b>	69365	145,60	275	1	Cromado · Chrome
<b>C</b>	69367	145,60	275	1	Cobre · Copper

## Lámpara de calentamiento extensible cónica

Lampe chauffante extensible conique  
Wärmelampe Kabel ausziehbar, konisch  
Conical heating lamp extensible  
Lâmpada de aquecimento ext. cônica

	Ref	€	W	U.Venta	
<b>A</b>	69564	131,20	275	1	Lijado · Sanding
<b>B</b>	69566	157,50	275	1	Cromado · Chrome
<b>C</b>	69565	160,20	275	1	Cobre · Copper

Ref	Tensión/Voltage	Potencia/Power	Dist. lámp. alimentos Lamp-food distance	Peso/Weight
69266	220-240 V; 50/60 Hz	275 W	50 - 60 cm	2,00 Kg
69365	220-240 V; 50/60 Hz	275 W	50 - 60 cm	2,00 Kg
69367	220-240 V; 50/60 Hz	275 W	50 - 60 cm	2,00 Kg
69564	220-240 V; 50/60 Hz	275 W	50 - 60 cm	1,60 Kg
69566	220-240 V; 50/60 Hz	275 W	50 - 60 cm	1,60 Kg
69565	220-240 V; 50/60 Hz	275 W	50 - 60 cm	1,60 Kg

# Colección **VITRINAS** expositoras



Desde Lacor lanzamos una nueva línea de vitrinas expositoras. Un total de 5 nuevos modelos de vitrinas neutras, calientes y refrigeradas, diseñadas especialmente para presentar y exponer todo tipo de alimentos, y garantizando siempre la calidad y conservación de estos.

Lacor lance une nouvelle ligne de vitrines d'exposition. Au total, ce sont 5 nouveaux modèles de vitrines neutres, chauffantes et réfrigérées, spécialement conçues pour présenter et exposer tout type d'aliments, toujours avec la garantie de leur qualité et leur conservation.

Lacor bringt eine neue Reihe von Vitrinen heraus. Insgesamt 5 neue Modelle mit oder ohne Kühlung/Heizung, speziell zum Anrichten und Anbieten aller möglichen Speisen mit Qualitäts- und Frischegarantie.

At Lacor we're launching a new line of display cases. There are 5 new models of neutral, warm and refrigerated display cases especially designed to present and display all kinds of food and ensure its quality and conservation at all times.

Lacor lança uma nova linha de vitrinas expositoras. Um de 5 novos modelos de vitrinas neutras, aquecidas e refrigeradas, especialmente concebidas para apresentar e expor todo o tipo de alimentos, garantindo sempre a sua qualidade e correta conservação.

## Vitrina NEUTRA



Parte trasera  
Back side

Puertas traseras abatibles  
Hinged rear doors

- Vitrina neutra construida íntegramente en cristal y base de acero inoxidable.
- Diseñada para presentar y exponer sobre la barra / mostrador.
- Superficie superior curvada para una visión panorámica.
- Estante intermedio de cristal templado.
- Puerta trasera abatible.
- 4 pies de goma que garantizan máxima estabilidad.

- Vitrine neutre íntegramente fabriquée en verre et base en acier inoxydable.
- Conçue pour présenter et exposer sur le plan de travail / comptoir.
- Surface supérieure courbée pour une vision panoramique.
- Étagère intermédiaire en verre trempé.
- Porte arrière rabattable.
- 4 pieds en caoutchouc qui garantissent une qualité maximale.

- Einfache Glasvitrine mit Edelstahlsockel.
- Zum Anrichten und Anbieten von Lebensmitteln an der Bar / Theke.
- Gewölbte Glasdecke für optimale Produktpräsentation.
- Mittlere Ablage aus Hartglas.
- Hinten aufklappbar.
- 4 GummifüÙe für maximale Standfestigkeit.

- Clear countertop display case made entirely of glass, including a stainless steel base.
- Designed for presenting and displaying food on the bar/countertop.
- Full view curved upper surface.
- Middle shelf made of tempered glass.
- Hinged rear door.
- 4 rubber feet for maximum stability.

- Vitrina neutra fabricada íntegralmente em vidro, com base de aço inoxidável.
- Para apresentar e expor no balcão / mostrador.
- Superfície superior curva para uma visão panorâmica.
- Prateleira intermédia de vidro temperado.
- Porta traseira rebatível.
- 4 patas de goma para total estabilidade.

### Vitrina neutra

Vitrine neutre  
Einfache Vitrine  
Clear countertop display case  
Vitrina neutra

Ref	€	cm	h (cm)	L	U.Venta
69601	285,30	55,4x37,6	37	45	1

# Vitrina TÉRMICA

**69602**

**Combinaciones posibles**  
Possible combinations

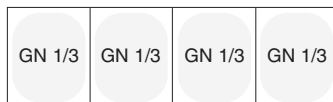
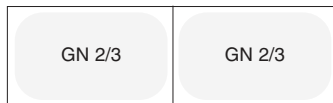

**69603**

**Combinaciones posibles**  
Possible combinations

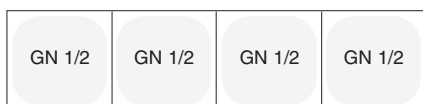

- Vitrina térmica fabricada en acero inoxidable y cristal.
- Diseñada para conservar, presentar y exponer sobre la barra / mostrador.
- Puertas correderas para una accesibilidad total.
- Superficie superior curvada para una visión panorámica.
- 4/6 cubetas gastronorm 1/3 incluidas.
- Termostato de control de temperatura regulable: 30-90°C.

- Vitrine thermique fabriquée en acier inoxydable et verre.
- Conçue pour conserver, présenter et exposer sur le plan de travail / comptoir.
- Portes coulissantes pour une accessibilité totale.
- Surface supérieure courbée pour une vision panoramique.
- 4/6 bacs gastronome 1/3 inclus.
- Thermostat de contrôle pour régler la température : 30-90°C.

- Warmhaltevitrine aus Edelstahl und Glas.
- Zum Aufbewahren, Anrichten und Anbieten von Lebensmitteln an der Bar / Theke.
- Schiebetüren für vollständigen Zugriff.
- Gewölbte Glasdecke für optimale Produktpräsentation.
- 4/6 Gastrobehälter 1/3 inbegriffen.
- Einstellbares Thermostat: 30-90°C.

- Thermal display case made of stainless steel and glass.
- Designed for storing, presenting and displaying food on the bar/counter top.
- Sliding doors for easy access.
- Full view curved upper surface.
- 4/6 Gastronorm 1/3 trays included.
- Adjustable temperature control thermostat: 30-90°C.

- Vitrina térmica fabricada em aço inoxidável e vidro.
- Para conservar, apresentar e expor sobre o balcão / mostrador.
- Portas de correr para total acessibilidade.
- Superfície superior curva para uma visão panorâmica.
- 4/6 cuvetes Gastronorm 1/3 incluídas.
- Termóstato de controlo de temperatura regulável de 30 a 90° C.



## Vitrina térmica

Vitrine thermique  
Warmhaltevitrine  
Thermal display case  
Vitrina térmica

	Ref	€	W	Capacidad	U.Venta
<b>A</b>	69602	636,20	500	4xGN1/3	1
<b>B</b>	69603	731,40	800	6xGN1/3	1

**4 / 6 cubetas gastronorm 1/3 incluidas**  
4/6 Gastronorm 1/3 trays included

**Parte trasera**  
Back side



Ref	Tensión/Voltage	Potencia/Power	Capacidad/Capacity	Temperatura/Temp.	Protección/Protection	Dimensiones/Sizes	Peso/Weight
69602	220-240 V; 50Hz	500 W	4 x GN 1/3	30°C - 90°C	IPX4	77,3x42x33,6 cm	16 Kg
69603	220-240 V; 50 Hz	800 W	6 x GN 1/3	30°C - 90°C	IPX4	112,7x42x33,6 cm	22 Kg

# Vitrina REFRIGERADA



**Control de temperatura regulable**  
Temperature control thermostat



**Tubo desagüe con tapón**  
Drain tube with cap

- Vitrina refrigerada construida íntegramente en cristal y acero inoxidable.
- Diseñada para conservar, presentar y exponer sobre la barra/mostrador.
- Puertas correderas para una accesibilidad total.
- Superficie superior curvada para una visión panorámica.
- Sistema de enfriamiento por compresor.
- 4/6 cubetas gastronorm 1/3 incluidas.
- Termostato de control de temperatura regulable: 0-12°C.
- Sistema de iluminación LED en la cámara interior y display de control de mandos.

- Vitrine réfrigérée intégralement fabriquée en verre et acier inoxydable.
- Conçue pour conserver, présenter et exposer sur le plan de travail/comptoir.
- Portes coulissantes pour une accessibilité totale.
- Surface supérieure courbée pour une vision panoramique.
- Système de refroidissement par compresseur.
- 4/6 bacs gastronome 1/3 inclus.
- Thermostat de contrôle pour régler la température : 0-12°C.
- Système d'éclairage LED dans la chambre intérieure et écran de contrôle de commandes.

- Kühlvitrine aus Glas und Edelstahl.
- Zum Aufbewahren, Anrichten und Anbieten von Lebensmitteln an der Bar/Theke.
- Schiebetüren für vollständigen Zugriff.
- Gewölbte Glasdecke für optimale Produktpräsentation.
- Kompressorkühlung.
- 4/6 Gastrobekälter 1/3 inbegriffen.
- Einstellbares Thermostat: 0–12°C.
- LED-Innenbeleuchtung und LED-Bedienfeld.

- Refrigerated display case made entirely of glass, including a stainless steel base.
- Designed for storing, presenting and displaying food on the bar/countertop.
- Sliding doors for easy access.
- Full view curved upper surface.
- Compressor cooling system.
- 4/6 Gastronorm 1/3 trays included.
- Adjustable temperature control thermostat: 0-12°C.
- LED lighting for inner chamber illumination and control display unit.

- Vitrina refrigerada fabricada integralmente em vidro e aço inoxidável.
- Para conservar, apresentar e expor sobre o balcão/mostrador.
- Portas de correr para total acessibilidade.
- Superfície superior curva para uma visão panorâmica.
- Sistema de refrigeração por compressor.
- 4/6 cusetes Gastronorm 1/3 incluídas.
- Termóstato de controlo de temperatura regulável de 0 a 12° C.
- Iluminação LED interior e display de controlo.

**Puertas traseras correderas**  
Sliding rear doors



## Vitrina refrigerada

Vitrine réfrigérée  
Kühlvitrine  
Refrigerated display case  
Vitrina refrigerada

	Ref	€	W	Capacidad	U.Venta
<b>A</b>	69605	1.236,70	160	4xGN1/3	1
<b>B</b>	69606	1.371,10	160	6xGN1/3	1

Ref	Tensión/Voltage	Potencia/Power	Capacidad/Capacity	Temperatura/Temp.	Refrigerante/Refrig.	Dimensiones/Sizes	Peso/Weight
69605	220-240 V; 50Hz	160 W	4 x GN 1/3	0°C - 12°C	R600a	112,1x45x33 cm	33 Kg
69606	220-240 V; 50 Hz	160 W	6 x GN 1/3	0°C - 12°C	R600a	148,3x45x33 cm	39 Kg

# Vitrina TÉRMICA

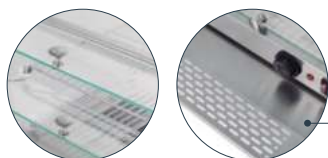

**Rejilla extraíble, facilita el flujo del calor**  
Removable racks for better heat flow



**Parte trasera**  
Back side



**Puertas traseras abatibles**  
Hinged rear doors

## Vitrina térmica

Vitrine thermique  
Warmhaltevitrine  
Thermal display case  
Vitrina tèrmica

Ref	€	W	L	U.Venta
69604	577,00	800	45	1

- Vitrina térmica fabricada en acero inoxidable y cristal.
- Diseñada para conservar, presentar y exponer sobre la barra/mostrador.
- Puerta trasera abatible.
- Superficie superior inclinada para una visión panorámica.
- Recipiente de agua extraíble que aporta humedad en la cámara.
- Termostato de control de temperatura regulable: 30-90°C.
- Bandeja de rejilla extraíble que facilita el flujo del calor.

- Vitrine thermique fabriquée en acier inoxydable et verre.
- Conçue pour conserver, présenter et exposer sur le plan de travail/comptoir.
- Porte arrière rabattable.
- Surface supérieure inclinée pour une vision panoramique.
- Récipient d'eau extractible qui apporte de l'humidité à la chambre.
- Thermostat de contrôle pour régler la température : 30-90°C.
- Plateau grillagé extractible qui facilite le flux de chaleur.

- Warmhaltevitrine aus Edelstahl und Glas.
- Zum Aufbewahren, Anrichten und Anbieten von Lebensmitteln an der Bar/Theke.
- Hinten aufklappbar.
- Geneigte Glasdecke für optimale Produktpräsentation.
- Herausnehmbarer Wasserbehälter sorgt für Luftfeuchtigkeit im Innenbereich.
- Einstellbares Thermostat: 30-90°C.
- Ausziehbarer Ablagerost für gute Wärmezirkulation.

- Thermal display case made of stainless steel and glass.
- Designed for storing, presenting and displaying food on the bar/countertop.
- Hinged rear door.
- Full view curved upper surface.
- Removable water tray to keep the chamber moist.
- Adjustable temperature control thermostat: 30-90°C.
- Removable racks for better heat flow.

- Vitrina térmica fabricada em aço inoxidável e vidro.
- Para conservar, apresentar e expor sobre o balcão/mostrador.
- Porta traseira rebatível.
- Superfície superior inclinada para uma visão panorâmica.
- Recipiente de água extraível, que preserva a humidade na câmara.
- Termóstato de controlo de temperatura regulável de 30 a 90°C.
- Bandeja de rede extraível, que facilita a circulação do calor.

Ref	Tensión/Voltage	Pot./Power	Capacidad/Capacity	Temp./Temp.	Protec./Protection	Parrilla/Grill	Parrilla/Grill (h)	Dimensiones/Sizes	Peso/Weight
69604	220-240 V; 50 Hz	800	45	30°C - 90°C	IPX4	52,5x28,5 cm	8,5 cm / 10 cm	55,4x37,6x37,6 cm	14,4 Kg

# Vitrina REFRIGERADA



## Vitrina refrigerada

Vitrine réfrigérée  
Kühlvitrine  
Refrigerated display case  
Vitrina refrigerada

Ref	€	W	L	U.Venta
69607	1.084,00	105	40	1



**Parte trasera**  
Back side

- Vitrina refrigerada construida íntegramente en cristal y acero inoxidable.
- Diseñada para conservar, presentar y exponer sobre la barra/mostrador.
- Puertas correderas para una accesibilidad total.
- Superficie superior inclinada para una visión panorámica.
- Sistema de enfriamiento por compresor. Función Defrost.
- Termostato de control de temperatura regulable: 2-12°C.
- Sist. de iluminación LED en la cámara interior y display de control de mandos.

- Vitrine réfrigérée intégralement fabriquée en verre et acier inoxydable.
- Conçue pour conserver, présenter et exposer sur le plan de travail/comptoir.
- Portes coulissantes pour une accessibilité totale.
- Surface supérieure courbée pour une vision panoramique.
- Système de refroidissement par compresseur.
- Thermostat de contrôle pour régler la température : 0-12°C.
- Syst. d'éclairage LED dans la chambre intérieure et écran de contrôle de commandes.

- Kühlvitrine aus Glas und Edelstahl.
- Zum Aufbewahren, Anrichten und Anbieten von Lebensmitteln an der Ba/Theke.
- Schiebetüren für vollständigen Zugriff.
- Geneigte Glasdecke für optimale Produktpräsentation.
- Kompressorkühlung. Abtaufunktion (Defrost).
- Einstellbares Thermostat: 2-12°C.
- LED-Innenbeleuchtung und LED-Bedienfeld.

- Refrigerated display case made entirely of glass, including a st. steel base.
- Designed for storing, presenting and displaying food on the bar/countertop.
- Sliding doors for easy access.
- Full view curved upper surface.
- Compressor cooling system. Defrost function.
- Adjustable temperature control thermostat: 2-12°C.
- LED lighting for inner chamber illumination and control display unit.

- Vitrina refrigerada fabricada integralmente em vidro e aço inoxidável.
- Para conservar, apresentar e expor sobre o balcão/mostrador.
- Portas de correr para total acessibilidade.
- Superfície superior inclinada para uma visão panorâmica.
- Sistema de refrigeração por compressor. Função Defrost.
- Termóstato de controlo de temperatura regulável de 2 a 12°C.
- Iluminação LED interior e display de controlo.

Ref	Tensión/Voltage	Potencia/Power	Capacidad/Capacity	Temperatura/Temp.	Refrigerante/Refr.	Dimensiones/Sizes	Peso/Weight
69607	220-240 V; 50Hz	105 W	40	2°C - 12°C	R600a	68x57,5x33,5 cm	25 Kg

---

# Gastro

---

Gastro





**Cubetas**  
Containers

**Transporte · Estanterías**  
Transport · Shelves

**Cestas**  
Racks

**Limpieza**  
Cleaning



# SOPORTES para cubetas Gastronorm

Inox  
18/10



- Fabricado en acero inoxidable 18/10.
- Organiza los alimentos y ahorre tiempo en la preparación de platos.
- Ideal para cocinas profesionales, restaurantes, buffet, autoservicios, etc.
- Travesaños verticales amovibles diseñados para combinar cubetas de distintos tamaños de hasta 200 mm de profundidad.
- Pies de goma antideslizantes que garantizan una óptima estabilidad.

- Fabriqué en acier inoxydable 18/10.
- Organisez les aliments et gagnez du temps lors de la préparation de vos plats.
- Idéal pour les cuisines professionnelles, les restaurants, les buffets, les self-services, etc.
- Barres transversales verticales amovibles conçues pour combiner des bacs de différentes tailles de 200 mm de profondeur.
- Pieds en caoutchouc antidérapants qui garantissent une stabilité optimale.

- Aus hochwertigem Edelstahl 18/10.
- Zum schnellen Anrichten zubereiteter Speisen.
- Ideal für gewerbliche Küchen, Gaststätten, Buffets, Selbstbedienungsrestaurant usw.
- Behälter unterschiedlicher Größe durch versetzbare Querstreben kombinierbar zu 200 mm Tiefe kombinierbar.
- Antirutschfüße aus Gummi für optimale Standfestigkeit.

- Made of 18/10 stainless steel.
- Organize food and save time while making dishes.
- Perfect for professional chefs, restaurants, buffets, self-service, etc.
- It has removable vertical cross pieces designed to combine trays of different sizes to 200 mm deep.
- The non-slip rubber feet ensure optimum stability.

- Fabricado em aço inoxidável 18/10.
- Organize os alimentos e poupe tempo na preparação dos seus pratos.
- Ideal para cozinhas profissionais, restaurantes, buffet, autosserviços, etc.
- Travessas verticais amovíveis, desenhadas para combinar cubetas de diferentes tamanhos de até 200 mm de profundidade.
- Patas de borracha antideslizantes, que asseguram uma ótima estabilidade.

## Cubetas GN no incluídas

Bacs GN non inclus · GN-behälter nicht inbegriffen · GN trays not included  
Cubetas GN não incluídas



## Diversas combinaciones posibles

Several possible combinations

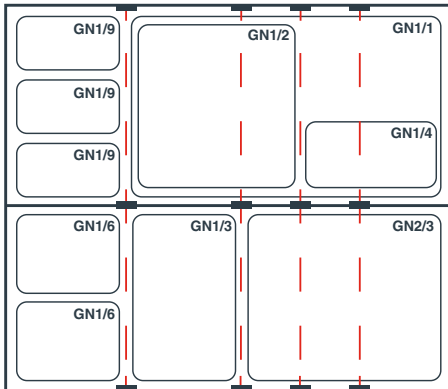







## Soporte para cubetas Gastronorm

Support de bacs Gastronorm  
Unterstützung für Gastronorm-Küvetten  
Gastronorm cuvette support  
Suporte de cubeta Gastronorm

	Ref	€	cm	Cubeta (cm)	U.Venta	
A	66245	81,90	78x49x46	34x26,5x2	1	Soporte simple · Simple support
B	66246	105,40	78x78x63	34x26,5x2	1	Soporte doble · Double support

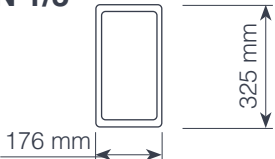
**COMPATIBILIDAD DE CUBETAS CON LOS SOPORTES**  
CONTAINERS COMPATIBILITY WITH SUPPORTS

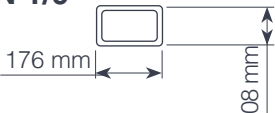
	INOX 18/10	INOX	PC	PP	MELAMINA
 <p><b>GN 2/1</b> 530 mm 650 mm</p>	<b>X</b>	<b>X</b>			
 <p><b>GN 1/1</b> 530 mm 325 mm</p>	✓	✓	✓	<b>X</b>	✓
 <p><b>GN 2/3</b> 354 mm 325 mm</p>	✓	✓	✓		✓
 <p><b>GN 2/4</b> 530 mm 165 mm</p>	<b>X</b>	<b>X</b>			<b>X</b>
 <p><b>GN 1/2</b> 265 mm 325 mm</p>	✓	✓	✓	<b>X</b>	✓
 <p><b>GN 1/3</b> 176 mm 325 mm</p>	✓	✓	✓	✓	✓
 <p><b>GN 1/4</b> 265 mm 162 mm</p>	<b>X</b>	<b>X</b>	✓	<b>X</b>	<b>X</b>
 <p><b>GN 1/6</b> 176 mm 162 mm</p>	✓	✓	✓	✓	✓
 <p><b>GN 1/9</b> 176 mm 108 mm</p>	✓	✓	✓	✓	

# Cubetas INOX 18/10 & INOX



- Fabricadas en acero inoxidable y acero inoxidable 18/10.
  - Apilables.
  - Aptas para procesos de refrigeración, congelación, hornos microondas o distribución de alimentos.
  - Higiénicos y fácilmente lavables, aptas para el lavavajillas.
- Fabriquées en acier inoxydable et en acier inoxydable 18/10.
  - Empilables.
  - Compatibles pour des processus de réfrigération, congélation, fours à micro-ondes ou distribution d'aliments.
  - Hygiéniques et facilement lavables, compatible lave-vaisselle.
- Hergestellt aus Edelstahl und Edelstahl 18/10.
  - Stapelbar.
  - Geeignet für Kühl-, Gefriervorgänge, Mikrowellenherde oder Nahrungsmittelverteilung.
  - Hygienisch und einfach zu reinigen, geschirrspülerfest.
- Manufactured in stainless steel and stainless steel 18/10.
  - Stackable.
  - Suitable for refrigeration and freezing processes, microwave ovens or food distribution.
  - Hygienic and easily washable, dishwasher safe.
- Fabricadas em aço inoxidável e aço inoxidável 18/10.
  - Empilháveis.
  - Aptos para processos de refrigeração, congelação, fornos micro-ondas ou distribuição de alimentos.
  - Higiénicos e facilmente laváveis, apto para a máquina de lavar louça.

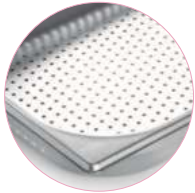
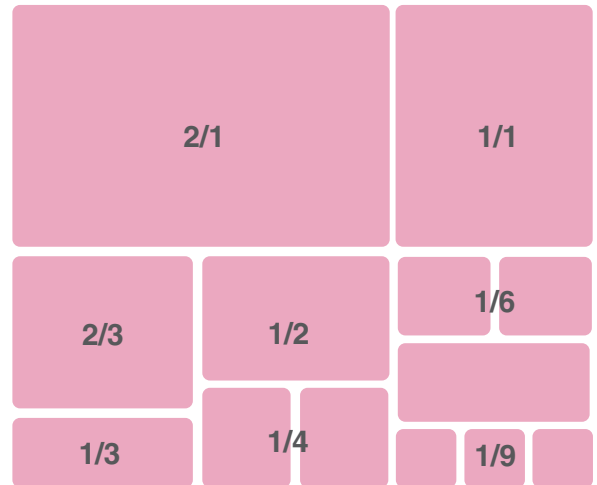

Ø del agujero perforado: Ø4 mm  
Drilled hole Ø: Ø4 mm

## Cubeta 2/1

Bac 2/1  
GN-Behälter 2/1  
Container 2/1  
Caixa 2/1



Inox 18/10	€	Inox	€	h (mm)	L	U.Venta	
66002	48,30	66002Z	42,90	20	6,50	1	Bandeja
66040	53,40	66040Z	48,40	40	11,00	1	Bandeja
66065	60,80	66065Z	50,90	65	18,90	1	Bandeja
66010	74,30	66010Z	62,30	100	31,50	1	
66015	89,80	66015Z	78,30	150	44,90	1	
66020	116,70	66020Z	104,50	200	60,00	1	

## Cubeta perforada 2/1

Bac perfore 2/1  
GN-Behälter, perforiert, 2/1  
Perforated container 2/1  
Caixa perforada 2/1



2/1  
530 x 650 mm

Inox 18/10	€	Inox	€	h (mm)	U.Venta	
-	-	-	-	-	-	-
66042	65,40	-	-	40	1	NO perf. lateral
66067	82,40	66067Z	57,80	65	1	NO perf. lateral
66012	101,40	66012Z	71,10	100	1	NO perf. lateral
66017	151,80	-	-	150	1	NO perf. lateral

## Cubeta 1/1

Bac 1/1  
GN-Behälter 1/1  
Container 1/1  
Caixa 1/1



Inox 18/10	€	Inox	€	h (mm)	L	U.Venta	
66102	23,90	66102Z	20,20	20	3,00	1	Bandeja
66140	25,00	66140Z	21,60	40	5,50	1	Bandeja
66155	28,10	66155Z	22,90	55	7,20	1	Bandeja
66165	30,20	66165Z	23,70	65	8,50	1	Bandeja
66110	43,00	66110Z	32,10	100	13,30	1	
66115	51,00	66115Z	44,20	150	20,60	1	
66120	60,20	66120Z	53,60	200	30,00	1	

1/1  
530 x 325 mm

## Cubeta perforada 1/1

Bac perforado 1/1  
GN-Behälter, perforiert, 1/1  
Perforated container 1/1  
Caixa perfurada 1/1



Inox 18/10	€	Inox	€	h (mm)	U.Venta	
66104	36,00	-	-	20	1	NO perf. lateral
66142	42,80	66142Z	24,10	40	1	
-	-	-	-	-	-	
66167	47,30	66167Z	26,00	65	1	
66112	60,80	66112Z	36,40	100	1	
66117	90,20	66117Z	58,80	150	1	
66122	103,50	66122Z	71,30	200	1	

## Cubeta 2/3

Bac 2/3  
GN-Behälter 2/3  
Container 2/3  
Caixa 2/3



Inox 18/10	€	Inox	€	h (mm)	L	U.Venta	
66502	20,70	66502Z	17,00	20	1,70	1	Bandeja
66540	26,10	66540Z	22,10	40	3,50	1	Bandeja
66565	29,90	66565Z	25,00	65	5,50	1	Bandeja
66510	37,10	66510Z	31,10	100	8,90	1	
66515	51,90	66515Z	43,40	150	13,60	1	
66520	69,10	66520Z	57,90	200	19,30	1	

2/3  
354 x 325 mm

## Cubeta perforada 2/3

Bac perforado 2/3  
GN-Behälter, perforiert, 2/3  
Perforated container 2/3  
Caixa perfurada 2/3



Inox 18/10	€	Inox	€	h (mm)	U.Venta	
-	-	-	-	-	-	
-	-	-	-	-	-	
-	-	66567Z	22,40	65	-	
-	-	66512Z	31,90	100	1	
-	-	66517Z	43,40	150	1	

2/4  
530 x 165 mm

## Cubeta 2/4

Bac 2/4  
GN-Behälter 2/4  
Container 2/4  
Caixa 2/4



Inox 18/10	€	Inox	€	h (mm)	L	U.Venta	
67604	22,60	67604Z	18,80	40	1,80	1	
67665	25,60	67665Z	21,00	65	4,50	1	
67610	31,70	67610Z	26,10	100	5,50	1	
67615	48,00	67615Z	39,30	150	8,50	1	

## Cubeta 1/2

Bac 1/2  
GN-Behälter 1/2  
Container 1/2  
Caixa 1/2



Inox 18/10	€	Inox	€	h (mm)	L	U.Venta	
66202	16,10	66202Z	11,30	20	1,20	1	Bandeja
66240	16,90	66240Z	11,70	40	2,50	1	Bandeja
-	-	66255Z	13,20	55	3,20	1	Bandeja
66265	19,30	66265Z	13,70	65	4,20	1	Bandeja
66210	28,10	66210Z	19,30	100	8,00	1	
66215	36,00	66215Z	27,80	150	9,90	1	
66220	46,00	66220Z	34,30	200	11,60	1	

1/2  
265 x 325 mm

## Cubeta perforada 1/2

Bac perforado 1/2  
GN-Behälter, perforiert, 1/2  
Perforated container 1/2  
Caixa perfurada 1/2



Inox 18/10	€	Inox	€	h (mm)	U.Venta	
-	-	-	-	-	-	
66242	30,30	-	-	40	1	NO perf. lateral
-	-	-	-	-	-	
66267	34,80	-	-	65	1	
66212	42,70	-	-	100	1	
66217	57,80	-	-	150	1	
66222	80,20	-	-	200	1	

## Cubeta 1/3

Bac 1/3  
GN-Behälter 1/3  
Container 1/3  
Caixa 1/3



1/3  
176 x 325 mm

Inox 18/10	€	Inox	€	h (mm)	L	U.Venta	
66302	15,10	66302Z	8,60	20	0,80	6	Bandeja
66340	15,20	66340Z	9,40	40	1,60	6	Bandeja
66355	15,70	66355Z	9,70	55	2,00	6	Bandeja
66365	15,90	66365Z	9,90	65	2,50	6	Bandeja
66310	22,80	66310Z	15,70	100	3,80	1	
66315	33,30	66315Z	21,00	150	5,90	1	
66320	38,20	66320Z	24,90	200	8,10	1	

## Cubeta 1/4

Bac 1/4  
GN-Behälter 1/4  
Container 1/4  
Caixa 1/4



1/4  
265 x 162 mm

Inox 18/10	€	Inox	€	h (mm)	L	U.Venta	
66402	11,30	66402Z	7,80	20	0,60	6	
66465	12,70	66465Z	8,60	65	1,90	6	
66410	18,90	66410Z	13,30	100	2,50	1	
66415	25,90	66415Z	17,80	150	4,10	1	
66420	35,30	66420Z	21,40	200	4,90	1	

## Cubeta 1/6

Bac 1/6  
GN-Behälter 1/6  
Container 1/6  
Caixa 1/6



1/6  
176 x 162 mm

Inox 18/10	€	Inox	€	h (mm)	L	U.Venta	
66665	10,30	66665Z	6,90	65	1,10	6	
66610	16,40	66610Z	10,60	100	1,60	6	
66615	25,70	66615Z	14,70	150	2,50	1	
66620	32,30	66620Z	17,30	200	3,30	1	

## Cubeta 1/9

Bac 1/9  
GN-Behälter 1/9  
Container 1/9  
Caixa 1/9



1/9  
176 x 108 mm

Inox 18/10	€	Inox	€	h (mm)	L	U.Venta	
66965	8,90	66965Z	5,10	65	0,70	6	
66910	15,40	66910Z	8,10	100	0,85	6	

## Guia divisora

Guide de division  
GN Zwischensteg  
Splitting guides  
Guia divisória



Inox 18/10	€	Inox	€	L (mm)	U.Venta
66923	14,70	66923Z	6,10	530	1
66925	10,90	66925Z	4,00	325	1

## Doble fondo perforado

Double fond perforé  
Doppel-Boden gelocht  
Punched double bottom perf.  
Duplo fundo perfurado



Inox 18/10	€	Inox	€	Cubeta
66909	111,70	-	-	2/1
66911	35,60	66911Z	23,70	1/1
66912	24,30	66912Z	16,00	1/2

## Tapa para cubeta

Couvercle pour bac  
GN Deckel  
Container lid  
Tampa para caixa



Inox 18/10	€	Inox	€	Cubeta	U.Venta
-	-	66908DZ	39,00	2/1	1
66901D	26,80	66901DZ	18,60	1/1	1
66905D	21,30	66905DZ	12,80	2/3	1
66907	17,10	-	-	2/4	1
66902D	14,20	66902DZ	9,10	1/2	6
66903D	11,30	66903DZ	7,00	1/3	6
66904D	9,60	66904DZ	6,50	1/4	6
66906D	7,20	66906DZ	3,80	1/6	6
66909D	6,70	66909DZ	2,90	1/9	6

## Tapa para cubeta

Couvercle pour bac  
GN Deckel  
Container lid  
Tampa para caixa



Inox 18/10	€	Inox	€	Cubeta	U.Venta
67901	26,70	67901Z	18,70	1/1	1
67905	16,30	67905Z	11,30	2/3	1
67902	14,60	67902Z	10,10	1/2	6
67903	10,60	67903Z	7,30	1/3	6
67904	8,90	67904Z	6,10	1/4	6
67906	7,30	67906Z	5,10	1/6	6
67909	6,10	67909Z	4,30	1/9	6

**SI**

Silicone

**Tapa para cubeta**

Couvercle pour bac  
GN Deckel  
Container lid  
Tampa para caixa



Inox 18/10	€	Inox	€	Cubeta	U.Venta
66901	79,10	66901Z	47,30	1/1	1
66903	63,80	66903Z	33,40	2/3	1
66902	57,90	66902Z	37,10	1/2	1
66904	46,80	66904Z	25,90	1/3	1
66905	43,40	66905Z	24,10	1/4	1

**Inox****Parrilla**

Grille  
GN Drahtgitter  
Grill  
Grelha



Ref	€	cm	Cubeta	U.Venta
66920	53,60	65x53	2/1	1
66921	20,60	53x32,5	1/1	1

**Pinza para horno y bandeja GN**

Pince inox pour bac Gastronorm  
Zange für GN Behälter  
Tong GN tray  
Pinça para forno e bandejas GN

Ref	€	L (cm)	U.Venta
62989	17,00	20	12

**SI 200°C**

Silicone max

**Pinza con silicona para horno y bandeja**

Pince Inox pour bac Gastronorm avec Silicone  
Zange für GN Behälter, mit Silikon  
Oven tray tong with Silicone  
Pinça para forno e bandejas com silicone

Ref	€	L (cm)	U.Venta
62998	17,00	20	12

**Cubeta helado INOX 18/10 • Tapa PC****Inox 18/10**

Stackable



Dishwasher

- Cubetas fabricadas en acero inoxidable 18/10.
- Diseñados para conservar el helado.
- Bordes perfilados para un agarre óptimo y funcional.
- Disponible en tres alturas: 80, 120 y 150 mm.

- Bacs fabriqués en acier inoxydable de la plus grande qualité.
- Conçus pour conserver la glace.
- Bords profilés pour une prise en main optimale et fonctionnelle.
- Disponibles en trois formats : 80, 120 et 150mm.

- Gastrobehälter aus hochwertigem Edelstahl höchster Qualität.
- Zum Frischhalten und Aufbewahren von Eis.
- Randtextur für optimalen, handlichen Griff.
- In drei Größen erhältlich: 80, 120 und 150 mm.

- Top quality stainless steel pans.
- Designed for storing ice cream.
- Shaped edges for optimal and functional handling.
- Three sizes available: 80, 120 and 150 mm.

- Cuvetes fabricadas em aço inoxidável da máxima qualidade.
- Concebidas para conservar corretamente o gelado.
- Bordas perfiladas para uma ótima sujeição e maior funcionalidade.
- Disponíveis em três tamanhos: 80, 120 e 150 mm.

**Cubeta para helado**

Bac à glace  
Eiskübel  
Ice cream container  
Caixa de sorvete

Ref	€	cm	h (cm)	L	U.Venta
66178	27,10	36x16,5	8	3,8	1
66172	27,20	36x16,5	12	5,0	1
66175	34,30	36x16,5	15	6,5	1

**PC**

Polycarbonate

**Tapa para cubeta**

Couvercle pour bac  
GN Deckel  
Container lid  
Tampa para caixa



Ref	€	cm	h (cm)	U.Venta
66900P	9,60	36x16,5	7,6	1

# Cubetas POLICARBONATO



## Cubeta GN 1/1

Bac GN 1/1  
GN-Behälter 1/1  
GN container 1/1  
Caixa GN 1/1



1/1  
530 x 325 mm

- Fabricadas en policarbonato. Ligeras, indeformables y apilables.
- Apts para procesos de refrigeración, congelación, hornos microondas o distribución de alimentos (-100°C/100°C).
- Higiénicos y fácilmente lavables, aptas para el lavavajillas.

Ref	€	h (mm)	L	U.Venta
66165P	23,40	65	8,50	1
66110P	28,80	100	13,30	1
66115P	35,30	150	20,60	1
66120P	43,50	200	30,00	1

- Fabriquées en polycarbonate. Légères, indéformables et empilables.
- Compatibles pour des processus de réfrigération, congélation, fours à micro-ondes ou distribution d'aliments (-100°C/100°C).
- Hygiéniques et facilement lavables, compatible lave-vaisselle.

- Aus Polycarbonat hergestellt. Leicht, nicht verformbar und stapelbar.
- Geeignet für Kühl-, Gefriervorgänge, Mikrowellenherde oder Nahrungsmittelverteilung (-100°C/100°C).
- Hygienisch und einfach zu reinigen, geschirrspülerfest.

## Cubeta GN 1/2

Bac GN 1/2  
GN-Behälter 1/2  
GN container 1/2  
Caixa GN 1/2



1/2  
265 x 325 mm

- Manufactured in polycarbonate. Light, non-deformable and stackable.
- Suitable for refrigeration and freezing processes, microwave ovens or food distribution (-100°C/100°C).
- Hygienic and easily washable, dishwasher safe.

Ref	€	h (mm)	L	U.Venta
66265P	12,40	65	4,20	1
66210P	16,40	100	8,00	1
66215P	21,20	150	9,90	1
66220P	25,90	200	11,60	1

- Fabricadas em policarbonato. Leves, indeformáveis e empilháveis.
- Apts para processos de refrigeração, congelação, fornos micro-ondas ou distribuição de alimentos (-100°C/100° C).
- Higiénicos e facilmente laváveis, apto para a máquina de lavar louça.

## Cubeta GN 1/3

Bac GN 1/3  
GN-Behälter 1/3  
GN container 1/3  
Caixa GN 1/3



1/3  
176 x 325 mm

Ref	€	h (mm)	L	U.Venta
66365P	10,10	65	2,50	1
66310P	13,10	100	3,80	1
66315P	16,30	150	5,90	1
66320P	19,90	200	8,10	1

## Cubeta GN 1/4

Bac GN 1/4  
GN-Behälter 1/4  
GN container 1/4  
Caixa GN 1/4



1/4  
265 x 162 mm

Ref	€	h (mm)	L	U.Venta
66465P	9,00	65	1,90	1
66410P	10,70	100	2,50	1
66415P	13,50	150	4,10	1

## Cubeta GN 1/6

Bac GN 1/6  
GN-Behälter 1/6  
GN container 1/6  
Caixa GN 1/6



1/6  
176 x 162 mm

Ref	€	h (mm)	L	U.Venta
66665P	7,60	65	1,10	1
66610P	8,10	100	1,60	1
66615P	9,70	150	2,50	1

## Cubeta GN 1/9

Bac GN 1/9  
GN-Behälter 1/9  
GN container 1/9  
Caixa GN 1/9



1/9  
176 x 108 mm

Ref	€	h (mm)	L	U.Venta
66910P	7,60	100	0,70	1

## Tapa

Couvercle  
Deckel  
Lid  
Tampa



Ref	€	Cubeta	U.Venta
66901P	17,80	1/1	1
66902P	11,00	1/2	1
66903P	7,80	1/3	1
66904P	6,40	1/4	1
66906P	4,80	1/6	1
66909P	3,80	1/9	1

## Doble fondo perforado

Double fond perforé  
Doppel-Boden gelocht  
Punched double bottom perf.  
Duplo fundo perfurado



Ref	€	Cubeta	U.Venta
66911P	13,30	1/1	1
66912P	7,30	1/2	1
66913P	4,70	1/3	1
66914P	3,70	1/4	1
66916P	3,30	1/6	1

# Cubetas POLIPROPILENO



## Cubeta 1/1

Bac 1/1  
GN-Behälter 1/1  
Container 1/1  
Caixa 1/1



1/1  
530 x 325 mm

- Fabricadas en polipropileno. Ligeros, indeformables y apilables.
- Cierre hermético. Higiénicas y fácilmente lavables.
- Aptas para procesos de refrigeración, congelación o distribución de alimentos (-40°C/70°C).

Ref	€	h (mm)	L	U.Venta
66165H	11,00	65	8,50	1
66110H	13,10	100	12,90	1
66115H	16,40	150	19,50	1
66120H	21,00	200	25,90	1

- Fabriquées en polycarbonate. Légères, indéformables et empilables.
- Fermeture hermétique. Hygiéniques et facilement lavables.
- Compatibles pour des processus de réfrigération, congélation ou distribution d'aliments (-40°C/70°C).

- Aus Polypropylen hergestellt. Leicht, nicht verformbar und stapelbar.
- Hermetischer Verschluss. Hygienisch und einfach zu reinigen.
- Geeignet zum Kühlen, Einfrieren oder zur Verteilung von Lebensmitteln (-40°C/70°C).

## Cubeta 1/2

Bac 1/2  
GN-Behälter 1/2  
Container 1/2  
Caixa 1/2



1/2  
265 x 325 mm

Ref	€	h (mm)	L	U.Venta
66265H	5,70	65	3,90	6
66210H	8,10	100	5,90	6
66215H	9,40	150	8,80	6
66220H	11,10	200	10,80	1

- Manufactured in polypropylene. Light, non-deformable and stackable.
- Airtight seal. Hygienic and easily washable.
- Suitable for refrigeration and freezing processes and food distribution (-40°C/70°C).

- Fabricadas em polipropileno. Leves, indeformáveis e empilháveis.
- Fecho hermético. Higiénicos e facilmente laváveis.
- Aptos para processos de refrigeração, congelação ou distribuição de alimentos (-40°C/70°C).



## Cubeta 1/3

Bac 1/3  
GN-Behälter 1/3  
Container 1/3  
Caixa 1/3



1/3  
176 x 325 mm

Ref	€	h (mm)	L	U.Venta
66365H	4,60	65	2,40	6
66310H	5,50	100	3,80	6
66315H	6,70	150	5,10	6
66320H	8,20	200	6,90	6

## Cubeta 1/4

Bac 1/4  
GN-Behälter 1/4  
Container 1/4  
Caixa 1/4



1/4  
265 x 162 mm

Ref	€	h (mm)	L	U.Venta
66465H	3,80	65	1,70	6
66410H	5,10	100	2,40	6
66415H	5,50	150	3,70	6

## Cubeta 1/6

Bac 1/6  
GN-Behälter 1/6  
Container 1/6  
Caixa 1/6



1/6  
176 x 162 mm

Ref	€	h (mm)	L	U.Venta
66665H	3,50	65	1,00	6
66610H	3,70	100	1,60	6
66615H	5,20	150	2,20	6

## Cubeta 1/9

Bac 1/9  
GN-Behälter 1/9  
Container 1/9  
Caixa 1/9



1/9  
176 x 108 mm

Ref	€	h (mm)	L	U.Venta
66965H	2,50	65	0,60	6
66910H	3,50	100	0,90	6

## Tapa

Couvercle  
Deckel  
Lid  
Tampa



Ref	€	Cubeta	U.Venta
66901DH	8,30	1/1	6
66902DH	4,90	1/2	6
66903DH	3,60	1/3	6
66904DH	3,00	1/4	6
66906DH	2,10	1/6	6
66909DH	2,00	1/9	6

## Doble fondo perforado

Double fond perforé  
GN Einlege-Böden, gelocht  
Punched double bottom  
Duplo fundo perfurado



Ref	€	Cubeta	U.Venta
66911H	9,50	1/1	10
66912H	4,90	1/2	12
66913H	2,80	1/3	12
66914H	2,10	1/4	12
66916H	1,60	1/6	12



# Cubetas GN WHITE & BLACK



- Ligeras, indeformables y apilables.
- Higiénicas y fácilmente lavables.
- Aptas para procesos de refrigeración, congelación o distribución de alimentos.
- Légères, indéformables et empilables.
- Hygiéniques et facilement lavables.
- Compatibles pour des processus de réfrigération, congélation ou distribution d'aliments.
- Leicht, nicht verformbar und stapelbar.
- Hygienisch und einfach zu reinigen.
- Geeignet zum Kühlen, Einfrieren oder zur Verteilung von Lebensmitteln.
- Light, non-deformable and stackable.
- Hygienic and easily washable.
- Suitable for refrigeration and freezing processes and food distribution.
- Leves, indeformáveis e empilháveis.
- Higiênicos e facilmente laváveis.
- Aptos para processos de refrigeração, congelação ou distribuição de alimentos.

## Cubeta 1/1

Bac 1/1  
GN-Behälter 1/1  
Container 1/1  
Caixa 1/1



Ref	€	h (mm)	L	U.Venta
66165E	44,20	65	8,50	1
66110E	50,30	100	13,30	1

## Cubeta 1/1

Bac 1/1  
GN-Behälter 1/1  
Container 1/1  
Caixa 1/1



1/1  
530 x 325 mm

Ref	€	h (mm)	L	U.Venta
66165J	47,00	65	8,50	1
66110J	52,90	100	13,30	1

## Cubeta 1/2

Bac 1/2  
GN-Behälter 1/2  
Container 1/2  
Caixa 1/2



Ref	€	h (mm)	L	U.Venta
66265E	23,10	65	4,50	1
66210E	25,60	100	8,00	1

## Cubeta 1/2

Bac 1/2  
GN-Behälter 1/2  
Container 1/2  
Caixa 1/2



1/2  
265 x 325 mm

Ref	€	h (mm)	L	U.Venta
66265J	24,10	65	4,50	1
66210J	27,20	100	8,00	1

## Cubeta 1/3

Bac 1/3  
GN-Behälter 1/3  
Container 1/3  
Caixa 1/3



Ref	€	h (mm)	L	U.Venta
66365E	18,00	65	2,50	1
66310E	20,00	100	3,80	1

## Cubeta 1/3

Bac 1/3  
GN-Behälter 1/3  
Container 1/3  
Caixa 1/3



1/3  
176 x 325 mm

Ref	€	h (mm)	L	U.Venta
66365J	19,30	65	2,50	1
66310J	21,40	100	3,80	1

1/4  
265 x 162 mm

### Cubeta 1/4

Bac 1/4  
GN-Behälter 1/4  
Container 1/4  
Caixa 1/4



### Cubeta 1/4

Bac 1/4  
GN-Behälter 1/4  
Container 1/4  
Caixa 1/4



Ref	€	h (mm)	L	U.Venta
66465E	15,50	65	1,90	1
66410E	17,40	100	2,50	1

Ref	€	h (mm)	L	U.Venta
66465J	16,50	65	1,90	1
66410J	18,60	100	2,50	1

2/3  
350 x 325 mm

### Cubeta 2/3

Bac 2/3  
GN-Behälter 2/3  
Container 2/3  
Caixa 2/3



### Cubeta 2/3

Bac 2/3  
GN-Behälter 2/3  
Container 2/3  
Caixa 2/3



Ref	€	h (mm)	L	U.Venta
66565E	33,30	65	5,50	1

Ref	€	h (mm)	L	U.Venta
66565J	34,80	65	5,50	1

1/6  
176 x 162 mm

### Cubeta 1/6

Bac 1/6  
GN-Behälter 1/6  
Container 1/6  
Caixa 1/6



### Cubeta 1/6

Bac 1/6  
GN-Behälter 1/6  
Container 1/6  
Caixa 1/6



Ref	€	h (mm)	L	U.Venta
66665E	11,10	65	1,10	1
66610E	12,40	100	1,60	1

Ref	€	h (mm)	L	U.Venta
66665J	11,80	65	1,10	1
66610J	13,30	100	1,60	1

2/4  
530 x 165 mm

### Cubeta 2/4

Bac 2/4  
GN-Behälter 2/4  
Container 2/4  
Caixa 2/4



### Cubeta 2/4

Bac 2/4  
GN-Behälter 2/4  
Container 2/4  
Caixa 2/4



Ref	€	h (mm)	L	U.Venta
66765E	23,20	65	4,50	1

Ref	€	h (mm)	L	U.Venta
66765J	24,00	65	4,50	1

# Transporte • Estanterías

Transport • Shelves



# Colección **TERMOTRANS**

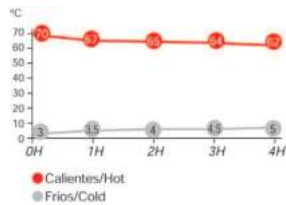

- Diseñado para el transporte de cubetas.
  - Contenedor isotérmico rígido, ligero, robusto y apilable.
  - Puerta sin bisagra, sistema de cierre en la tapa.
  - Ideal para transporte de alimentos en catering o cocinas.
- Conçu pour le transport de bacs.
  - Conteneur isotherme rigide, léger, robuste et empilable.
  - Porte sans charnière, système de verrouillage sur le couvercle.
  - Idéal pour le transport des aliments de restauration ou de cuisson.
- Entwickelt für den Transport von GN-Behältern.
  - Thermobehälter starre, leicht, robust und stapelbar.
  - Tür ohne Scharnier, Verriegelungssystem des Deckels.
  - Ideal für den Transport von Lebensmitteln Catering oder Kochen.
- Designed for transporting containers.
  - Isothermal container rigid, lightweight, sturdy and stackable.
  - Door without hinge, locking system on the lid.
  - Ideal for transporting food catering or cooking.
- Projetado para transportar caixas.
  - Recipiente isotérmico rígida, leve, resistente e empilhável.
  - Porta sem dobradiça, sistema de bloqueio sobre a tampa.
  - Ideal para o transporte de alimentos em restauração ou cozinhar.

## Thermotrans 100 17 L

Thermotrans  
Thermotrans  
Thermotrans  
Thermotrans

Ref	€	cm	U.Venta
66099	606,10	41x62x24	1



1xGN 1/1 - 100



1xGN 2/3 + 1xGN1/3 - 100



## Thermotrans 300 34 L

Thermotrans  
Thermotrans  
Thermotrans  
Thermotrans

Ref	€	cm	U.Venta
66299	649,00	41x62x37	1



2xGN 1/2 - 200



3xGN 1/3 - 200



4xGN 1/4 - 200



## Thermotrans 600 72L

Thermotrans  
Thermotrans  
Thermotrans  
Thermotrans

Ref	€	cm	U.Venta
66599	801,80	45x62,5x57,5	1



12xGN 1/1-20



6xGN 1/1-65



4xGN1/1-100



3xGN1/1-150



2xGN1/1-200



# Colección **CARROS**

Inox **PP**  
Polypropylene **BPA free**

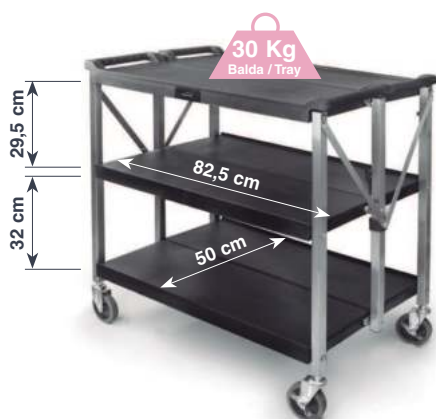

**Fácil de plegar**  
Easy to fold



- Elegante diseño, perfecto para restaurantes, bares, cocinas, etc.
- Ideal para uso en interiores como exteriores.
- Construido con materiales resistentes y ligeros.
- Asas en ambos lados para facilitar su manejo.
- Ruedas giratorias multidireccionales que facilitan la movilidad en cualquier superficie.
- Dos ruedas con freno de bloqueo para mayor seguridad.
- Tres estantes que soportan 30 kg cada uno.
- Se pliega por la mitad para facilitar su almacenaje.
- Dispone de pestillo de bloqueo para mantener el carro en la posición plegada.

- Style élégant, parfait pour les restaurants, bars, cuisines, etc.
- Idéal pour une utilisation aussi bien en intérieur qu'en extérieur.
- Fabriqué avec des matériaux résistants et légers.
- Poignées des deux côtés pour faciliter sa manipulation.
- Roues pivotantes multidirectionnelles qui facilitent la mobilité sur tout type de surface.
- Deux roues avec frein de blocage pour une plus grande sécurité.
- Trois étagères qui supportent 30 kg chacune.
- Se plie en deux pour faciliter son rangement.
- Dispose d'une languette de blocage pour maintenir le chariot en position pliée.

- Die elegante Form eignet sich ideal für Restaurants, Bars, Küche usw.
- Für den Außen- und Innenbereich.
- Aus robusten und leichten Materialien.
- Gut an den Griffen an beiden Seiten lenkbar.
- Rollen wechseln die Richtung und laufen auf jeder Oberfläche.
- Zwei Rollen mit und zwei ohne Feststeller für mehr Sicherheit.
- Drei Etagen mit je max. 30 kg Belastung.
- In der Mitte faltbar, platzsparend.
- Gefalteter Wagen kann mit Arretierung fixiert werden.

- It has an elegant design that is perfect for restaurants, bars or kitchens, etc.
- It's perfect for indoor or outdoor use.
- It's built with strong and lightweight materials.
- It has handles on both sides for easy carrying.
- The multi-directional rotating wheels make it easy to move on any surface.
- It has two wheels with a brake for greater safety.
- It has three shelves that can hold 30 kg each.
- It folds in half for easy storage.
- It has a locking tab to keep the cart in a folded position.

- Design elegante, ideal para restaurantes, bares, cozinhas, etc.
- Concebido para uso interior e exterior.
- Fabricado com materiais leves e resistentes.
- Asas de ambos os lados para facilitar o seu manejo.
- Rodas giratórias multidirecionais, que facilitam a mobilidade em qualquer superfície.
- Duas rodas com travão de bloqueio para maior segurança.
- Três prateleiras, com capacidade para suportar 30 kg cada uma.
- Dobra-se pela metade, para facilitar o seu armazenamento.
- Dispõe de uma pestana de bloqueio para manter o carro na posição dobrada.



**Pestillo de bloqueo**  
Locking tab

**Ruedas giratorias multidireccionales**  
**Dos ruedas con freno de bloqueo**  
Multi-directional rotating wheels  
Two wheels with a brake

## Carro de servicio plegable

Chariot de service pliable  
Faltbarer servierwagen  
Folding service cart  
Carro de serviço dobrável

Ref	€	cm	Balda	U.Venta
66247	433,80	93x51x93,5	30 kg	1



### Carro servicio 2 bandejas

Chariot de service avec 2 plateaux  
 Servierwagen, 2 Regale  
 Service trolley with 2 shelves  
 Carro serviço 2 bandejas

Ref	€	cm	U.Venta
66249	185,70	82x64,5x94,5	1

Entrega desmontado · Dismantled delivery

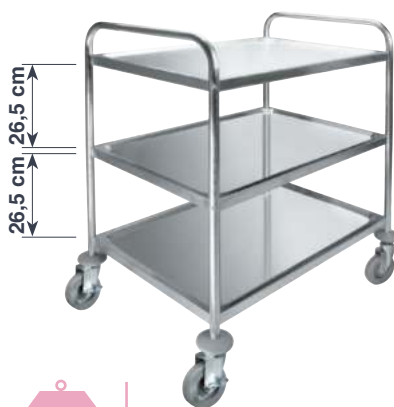

### Carro servicio 3 bandejas

Chariot de service avec 3 plateaux  
 Servierwagen, 3 Regale  
 Service trolley with 3 shelves  
 Carro serviço 3 bandejas

Ref	€	cm	U.Venta
66349	240,50	82x64,5x94,5	1

Entrega desmontado · Dismantled delivery



### Carro servicio 3 bandejas soldado

Chariot de service 3 plateaux  
 Servierwagen, 3 Regale  
 Service trolley 3 shelves  
 Carro serviço 3 bandejas soldado

Ref	€	cm	U.Venta
66350	706,70	82x64,5x94,5	1

Entrega montado · Mounted delivery



PE  
 Polyethylene



### Carro servicio 3 bandejas

Chariot de service avec 3 plateaux  
 Servierwagen, 3 Regale  
 Service trolley with 3 shelves  
 Carro serviço 3 bandejas

Ref	€	cm	U.Venta
66353	264,20	103x49x95	1

Entrega desmontado · Dismantled delivery

### Contenedor cubiertos plástico

Bac plastique pour couverts  
 Besteckebehälter aus Plastik  
 Cutlery plastic bin  
 Recipiente de talheres plástico



Ref	€	cm	U.Venta
66351	39,00	33x23x18	1

### Contenedor desperdicios plástico

Bac à déchets plastique  
 Müllbehälter aus Plastik  
 Rubbish plastic bin  
 Recipiente de desperdícios em plástico



Ref	€	cm	U.Venta
66352	65,10	33x284x56	1

MAX: Ø30,5 cm  
 MIN: Ø19 cm  
 CAP: 360 units



### Carro portaplatos

Chariot porte-plateau  
 Tellerwagen  
 Dish cart  
 Carro porta-pratos

Ref	€	cm	h (cm)	U.Venta
66555	1.340,10	96x71	81,0	1



### Funda carro portaplatos

Housse chariot porte-plateau  
 Abdeckung für tellerwagen  
 Dish cart cover  
 Capa protectora carro porta-pratos



Ref	€	cm	U.Venta
62964	47,80	96x71x60	1



MAX: Ø28 cm  
MIN: Ø8 cm  
CAP: 100 units

### Carro portaplatos con ruedas 100 platos

Hors devoirs chariot 100 plate  
Tellertransportwagen 100 teller  
100 Plate stack trolley assembled  
Carro porta-plateos com rodas 100 pratos

Ref	€	cm	U.Venta
66550	1.693,50	70x70x195	1

Entrega montado · Mounted delivery

Ø tubo · tube: 1,7 cm

Separación entre tubos · Separation between tubes: 5 cm

Inox  
18/10



### Estante tubular Inox

Étagère tubulaire en Inox  
Rohrgestell-Regal, Rostfrei  
St. steel tubular shelf  
Prateleira tubular Inóx

250 mm				400 mm				
Ref	€	L (mm)	L (mm)	Ref	€	L (mm)	L (mm)	U.Venta
56212	126,10	1200	250	56412	183,20	1200	400	1
56216	137,40	1600	250	56416	196,10	1600	400	1

### Carro portabandejas

Chariot à glissières  
Gestellwagen  
Rack trolley  
Carro porta-bandejas

Ref	€	Cubeta	Baldas	A (cm)	cm	U.Venta
66116	883,90	GN 1/1	17	7,5	38x55x172	1
66118	981,40	GN 2/1	17	7,5	58x69x172	1
66642	827,00	60x40	20	6,0	45x62x172	1

Entrega desmontado · Dismantled delivery



# Bandejas AUTOSERVICIO



Asas de silicona  
Silicone handles

5 compartimentos  
5 compartments

**Inox**  
**18/10**

**Inox**

**Si**  
Silicona

- Ideal para diferentes colectivos como buffets, self-service, hospitales, colegios, guarderías, campamentos, etc.
- 4 compartimentos para alimentos y 1 para cubiertos.
- Higiénicas, fáciles de recoger, limpiar y guardar; ocupan poco espacio.
- Apilables.

- Idéal pour différents groupes tels que buffets, self-service, hôpitaux, écoles, crèches, camps, etc.
- 4 compartiments pour les aliments et 1 pour les couverts.
- Hygiénique, faciles à collecter, nettoyer et ranger; il prend peu de place.
- Empilable.

- Ideal for different groups such as buffets, self-service, hospitals, schools, nurseries, camps, etc.
- 4 compartments for food and 1 for cutlery.
- Hygienic, easy to collect, clean and store; it takes up little space.
- Stackable.

## Bandeja autoservicio

Plateau libre-service  
Selbstbedienungstablent  
Self-service tray  
Bandeja self-service

Ref	€	Material	cm	h (cm)	U.Venta
66957	25,70	Inox 18/10	32,5x37,5	3,6	1
66957Z	21,50	Inox	32,5x37,5	3,6	1
R66957A	0,80	Silicona	-	-	1

Set 2 asas silicona  
Set 2 silicone handles

## PP

Polypropylene



## Bandeja servicio

Plateau rectangulaire  
Tablet, rechteckig  
Rectangular tray  
Bandeja de servir

Ref	€	cm	U.Venta
66953	17,40	53x37	1

La misma bandeja sirve como tapa  
The same tray serves as a lid

5 compartimentos  
5 compartments



Tapa apta para bandejas polipropileno  
Lid suitable for polypropylene trays



Tapa apta para bandejas policarbonato  
Lid suitable for polycarbonate trays

## Bandeja autoservicio

Plateau self-service  
Selbstbedienung Tablet  
Self-service tray  
Bandeja auto-serviço

	Ref	€	Material	cm	U.Venta
A	66952	19,50	Polycarbonate	33x33	1
B	66951	11,90	Polypropylene	33x33	1
C	66961	19,80	Polycarbonate	33x33	1

## Tapa para bandeja autoservicio

Couvercle pour plateau self-service  
Deckel für Selbstbedienung Tablet  
Lid for self-service tray  
Tampa para bandeja auto-serviço

	Ref	€	Material	cm	U.Venta
A	66960	14,30	Polypropylene	53x37	1
B	66962	18,80	Polycarbonate	53x37	1

Tapas NO compatibles con la bandejas autoservicio INOX  
Lids NOT compatible with the INOX self-service trays



# Bandejas ISOTÉRMICAS

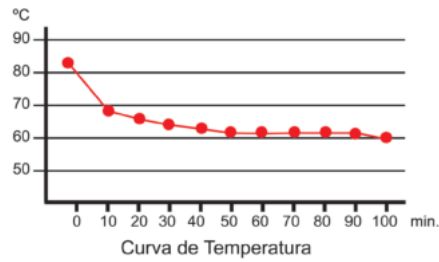

Rendimiento Térmico de las bandejas · Thermal isolation rate



## Bandeja isotérmica B-1

Plateau Isotherme B-1  
Isothermal Schale/Tablett B-1  
Isothermal B-1, Tray  
Bandeja isotérmica B-1

Ref	€	cm	U.Venta
66930	206,30	53x36,5	1

Tapa  
**PC**

Polycarbonate

## Plato llano policarbonato con tapa

Assiette plate polycarbonate avec couvercle  
Grosser Teller, Polycarbonat mit deckel  
Polycarbonate dinner plate with lid  
Prato raso policarbonato com tampa

Ref	€	cm	ml	U.Venta
66933	15,40	Ø22x3	1	Conjunto · Set
66933C	10,90	-	1	Plato · Plate
66940	4,60	-	12	Tapa · Lid

Tapa  
**PP**

Polypropylene

## Bol policarbonato con tapa

Bol polycarbonate avec couvercle  
Schüssel, Polycarbonat mit deckel  
Polycarbonate bowl with lid  
Tijela policarbonato com tampa

Ref	€	cm	ml	U.Venta	
66937	6,60	Ø13x6,5	450	1	Conjunto · Set
66937C	5,10	-	450	1	Bol · Bowl
66938	1,50	-	-	1	Tapa · Lid

Tapa  
**PP**

Polypropylene

## Taza doble pared policarbonato c/tapa

Coupelle dessert isotherme polycarb. a/couvercle  
Doppelwandiger Becher Polycarbonat mit Deckel  
Double wall polycarbonate mug w/lid  
Chávena parede duplo policarbonato com tampa

Ref	€	Ø (cm)	ml	U.Venta	
66949	12,50	8,5x7	250	1	Conjunto · Set
66949S	11,20	8,5x7	250	1	Taza · Cup
66949T	1,30	8,5	-	1	Tapa · Lid



## COMPOSICIÓN:

66930 - Bandeja isotérmica B-1  
66933 - Plato llano con tapa  
66934 - Plato hondo con tapa  
66937 - Bol con tapa  
66959 - Bol rectangular con tapa  
66956 - Cierre portafichas hermético

**6**

Pcs.

## Set completo bandeja isotérmica B-1

Set complet B-1  
Komplet-Set B-1  
Complete set B-1  
Conjunto completo bandeja isotérmica B-1

Ref	€	cm	U.Venta
66942	239,60	53x36,5	1

Tapa  
**PP**

Polypropylene

## Plato hondo policarbonato con tapa

Assiette creuse polycarbonate avec couvercle  
Suppenteller, Polycarbonat mit deckel  
Polycarbonate sopper plate with lid  
Prato fundo policarbonato com tampa

Ref	€	cm	ml	U.Venta	
66934	10,10	Ø19x5	450	1	Conjunto · Set
66934C	5,70	-	450	1	Plato · Plate
66939	4,40	-	-	1	Tapa · Lid

Tapa  
**PP**

Polypropylene

## Bol doble pared policarbonato c/tapa

Bol isotherme polycarb. a/couvercle  
Polycarbonat Schüssel, Isothermal mit Deckel  
Double wall polycarbonate bowl w/lid  
Tijela parede dupla policarbonato com tampa

Ref	€	Ø (cm)	ml	U.Venta	
66948	13,90	12,5x7	500	1	Conjunto · Set
66948S	12,50	12,5x7	500	1	Bol · Bowl
66938	1,50	12,5	-	1	Tapa · Lid

Tapa  
**PP**

Polypropylene

## Taza desayuno policarbonato c/tapa

Coupelle dessert polycarbonate a/couvercle  
Frühstückstasse Polycarbonat mit Deckel  
Polycarbonate breakfast cup w/lid  
Chávena pequeno-almoço policarbonato com tampa

Ref	€	Ø (cm)	ml	U.Venta	
66936	5,20	9x7	300	1	Conjunto · Set
66936C	4,00	9x7	300	1	Taza · Cup
66936T	1,20	9	-	1	Tapa · Lid

## Plato desayuno policarbonato

Assiette dessert polycarbonate  
Frühstücksteller, Polycarbonat  
Polycarbonate breakfast plate  
Prato de pequeno-almoço policarbonato



Ref	€	cm	U.Venta
66935	4,90	Ø18x2,5	1

Tapa

### PP

Polypropylene

## Bol cuadrado policarbonato c/tapa

Bac carre en polycarbonate avec couvercle  
Polycarbonat Behälter, Vierecking mit Deckel  
Square polycarbonate bowl with lid  
Caixa quadrada policarbonato com tampa



Ref	€	cm	ml	U.Venta	
66972	8,10	12x12x4,5	400	1	Conjunto · Set
66972C	5,20	12x12x4,5	400	12	Bol · Bowl
66975	2,90	12x12	-	1	Tapa · Lid

## Bol rectangular Policarbonato c/tapa

Bac rectangulière en Polycarbonate avec couvercle  
Polycarbonat Behälter, Rechtecking mit Deckel  
Rectangular Polycarbonate bowl with lid  
Caixa qrectangular policarbonato com tampa



Ref	€	cm	ml	U.Venta	
66959	8,10	9x13x4	400	1	Conjunto · Set
66957S	4,90	-	-	1	Bol · Bowl
66958	3,30	-	-	1	Tapa · Lid

Tapa

### PC

Polycarbonate

## Jarra policarbonato

Pot verser polycarbonate  
Krug, Polycarbonat  
Polycarbonate jug  
Jarra policarbonato



Ref	€	L	U.Venta	
66945	12,10	1,00	1	Conjunto · Set
66945S	9,20	1,00	1	Jarra · Jug
66945T	2,80	-	1	Tapa · Lid

125°C

max

## Tapa cubreplatos redondo Policarbonato

Couvercle pour assiettes Polycarbonate  
Polycarbonat Teller-Abdeckung  
Polycarbonate round plat cover  
Tampa cobre-pratos redonda policarbonato



Ref	€	Ø (cm)	U.Venta
66950	12,00	25x7	1

## Vaso policarbonato

Verre polycarbonate  
Glas, Polycarbonat  
Polycarbonate glass  
Copo policarbonato

A

B



Ref	€	Ø (cm)	ml	U.Venta
A 66947	2,30	7x10	250	1
B 66932	3,20	8,3x9,5	300	12

Tapa

### PP

Polypropylene

## Bol rectangular policarbonato c/tapa

Bac rectangulière en polycarbonate avec couvercle  
Polycarbonat Behälter, Rechtecking mit Deckel  
Rectangular polycarbonate bowl with lid  
Caixa qrectangular policarbonato com tampa



Ref	€	cm	ml	U.Venta	
66974	10,80	17x12	600	1	Conjunto · Set
66974C	6,70	17x12	600	1	Bol · Bowl
66977	4,00	17x12	-	1	Tapa · Lid

## Cierre portafichas hermético

Porte fiche  
Halierung für Inhaltverzeichnis  
Index card fasterner  
Fecho para bandejas isotérmicas



Ref	€	U.Venta
66956	2,70	1

20 bandejas  
20 trays



## Carro portabandejas

Chariot plateaux  
Wagen für Schale/Tablett  
Isothermal tray trolley  
Carro porta-bandejas

Ref	€	cm	U.Venta
66931	3.180,40	90x62x148	1

# Colección ESTANTERÍAS

PP AL 75°C  
Polypropilene Aluminium -30°C



## Capacidad por estante

Capacity per shelf

**Distribuir el peso uniformemente**  
Distributing the weight evenly

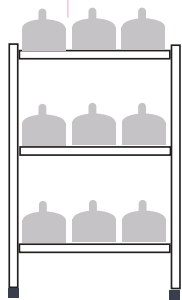

**Long**  
< 1 m **Max**  
> 1 m **120 Kg**  
**100 Kg**

Fondo  
385 mm

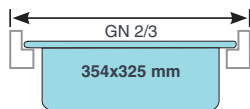

Fondo  
560 mm

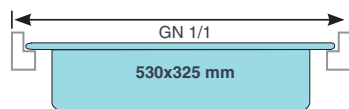

- Las estanterías modulares LACOR no precisan para su montaje/desmontaje de herramienta alguna, son fáciles de montar, robustas y ligeras.
- Construidas en materiales de alta calidad garantizan una larga duración, además de adecuarse al uso alimenticio en cámaras refrigeradas. La construcción modular permite al cliente adecuarse a la longitud y espacios disponibles, pudiendo ampliar y modificar la distribución en cualquier momento.
- Diseñadas para poder emplear cubetas GASTRONORM 2/1, 1/1 y 2/3, con dos anchuras de fondo disponibles, 560 mm y 385 mm.
- La distribución de los estantes permite el máximo aprovechamiento de la altura disponible, con un máximo de 11 estantes en altura 1750 mm y 12 estantes en altura de 2000 mm, con un peso máximo aproximado por estantería de 1.200 Kg. Con una altura útil mínima de 100 mm es especialmente recomendada para el almacenaje de medicamentos, artículos de ferretería o alimentos en conserva.
- Las distintas alturas de los estantes y su fácil montaje/desmontaje, permite que las distancias entre estantes puedan variarse a razón de 150 mm adicionales a los 100 mm iniciales (100mm/250mm/400mm/550mm)

- Les étagères modulables LACOR ne nécessitent aucun outil pour leur montage/démontage. Elles sont faciles à monter, robustes et légères.
- Elles sont construites dans des matériaux d'une grande qualité qui garantissent une longue durée de vie, et s'adaptent à une utilisation alimentaire dans les chambres froides.
- La construction modulable permet au client de les adapter à la longueur et aux espaces disponibles, avec la possibilité d'agrandir ou de modifier la distribution à tout moment.
- Conçues pour l'emploi de bacs GASTRONORM 2/1, 1/1 et 2/3, avec deux largeurs de fond disponibles, 560 mm et 385 mm. L'agencement des étagères permet de profiter au maximum de la hauteur disponible, avec un nombre limite de 11 étagères en hauteur de 1750 mm et de 12 étagères en hauteur de 2000 mm, pour un poids maximum d'environ 1.200 Kg par étagère. Avec une hauteur utile minimale de 100 mm, elle est spécialement conseillée pour stocker des médicaments, des articles de quincaillerie ou des aliments en conserve.
- Les différentes hauteurs des étagères et leur facilité de montage/démontage permettent de varier la distance entre étagères de 150 mm supplémentaires par rapport aux 100 mm d'origine (100mm/250mm/400mm/550mm).

- Für den Auf-/Abbau der Modulregale LACOR ist keinerlei Werkzeug erforderlich, sie sind einfach zu montieren, robust und leicht.
- Dank ihrer Fertigung aus hochwertigen Werkstoffen besitzen sie eine garantiert lange Lebensdauer und eignen sich für die Aufbewahrung von Lebensmitteln in Kühlräumen.
- Der modulare Aufbau ermöglicht es dem Kunden, sich an die zur Verfügung stehenden Längen- und Raummaße anzupassen, wobei sich die Anordnung jederzeit erweitern und ändern lässt.
- Ausgelegt für den Einsatz von Behältern GASTRONORM 2/1, 1/1 und 2/3, verfügbar in zwei Tiefen (560 mm und 385 mm). Die Anordnung der Regalfächer ermöglicht die größtmögliche Nutzung der verfügbaren Höhe. Bis zu 11 Fächern bei einer Höhe von 1750 mm und 12 Fächern bei einer Höhe von 2000 mm. Höchstgewicht pro Regalfach ca. 1200 kg. Bei einer Mindestnutzhöhe von 100 mm eignet sich das Regal besonders für die Aufbewahrung von Medikamenten, Eisenwarenartikeln oder Lebensmittelkonserven.
- Die unterschiedlichen Höhen der Regalfächer und deren einfache Montage/ Demontage bieten die Möglichkeit, die Abstände zwischen den Fächern nach dem anfänglichen Maß von 100 mm um jeweils 150 mm zu versetzen (100mm/250mm/400mm/550mm).

- No tools are required in the assembly/disassembly of LACOR modular shelving; they are easy to assemble, robust and light.
- Built in top-quality material, they are guaranteed to be long-lasting, and also apt for storing food in refrigerators.
- Their modular construction allows the client to fit them lengthwise into the available space, being able to expand and modify their distribution at anytime.
- Designed for use with GASTRONORM 2/1, 1/1 and 2/3 trays, with two available depths, 560mm and 385mm. The shelves' distribution allows for maximum use of available height, with a maximum height of 11 shelves at 1750mm and 12 shelves 2000mm, with an approximate maximum weight of 1,200kg per shelf. With a minimum height of 100mm, it's especially recommended for storing medicine, tools or canned foods.
- The different shelf heights and easy assembly / disassembly make it so the distances between shelves can vary by 150mm from the initial 100mm (100mm/250mm/400mm/550mm).

- Prateleiras modulares LACOR não exigida para a montagem / desmontagem ferramentas alguns, são fáceis de instalar, robustas e leves.
- Construído em materiais de alta qualidade para assegurar a longo prazo, também adaptados para uso alimentar em refrigeração.
- A construção modular permite ao cliente adequar-se a la longitud e espaços disponíveis, pode-se estender e mudança la distribuição a qualquer momento.
- Projetado para poder usar cubetas GASTRONORM 2/1, 1/1 e 2/3, com duas larguras de fundo disponíveis, 560 mm e 385 mm. A distribuição das prateleiras permite o uso máximo da altura disponível, com no máximo 11 prateleiras na altura 1750 mm e 12 prateleiras na altura de 2000 mm, com um peso máximo aproximado por prateleira de 1.200 Kg. Com uma altura útil mínima de 100 mm, é especialmente recomendado para o armazenamento de medicamentos, ferragens e alimentos enlatados.
- As diferentes alturas das prateleiras e sua fácil montagem / desmontagem, permitem que as distâncias entre prateleiras sejam variadas em 150 mm adicionais aos 100 mm iniciais (100 mm / 250 mm / 400 mm / 550 mm).

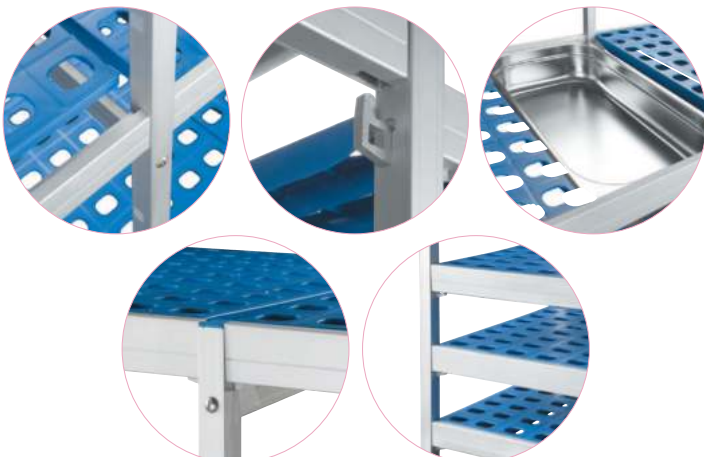

## Instrucciones montaje

Las estanterías LACOR no precisan de herramienta alguna para su montaje o desmontaje; siga estas instrucciones para poder realizar el montaje de una estantería simple. En caso de precisar cualquier aclaración o información adicional, no dude en ponerse en contacto con su suministrador o visite nuestra página web.

- 1.- Extraiga todos los componentes de su embalaje original, no se deshaga de este hasta comprobar que el artículo se encuentra completo.  
Coloque todos los componentes en el suelo.
- 2.- Disponga de un espacio libre, ampliamente superior a las dimensiones de la estantería a montar.
- 3.- Tome un soporte lateral extendido en el suelo, introduzca 2 ganchos en los orificios más bajos que vaya a emplear, tal y como muestra la figura 1.  
Apoye este soporte lateral contra la pared.
- 4.- Tome el otro soporte lateral e introduzca los ganchos en los mismos orificios. Coloque ahora los 2 largueros de la parte inferior (figura 2).
- 5.- Coloque de pie este soporte lateral y aproxímese al soporte lateral apoyada contra la pared, introduzca los largueros en los ganchos de éste, la estantería quedará estabilizada (figura 3).  
Asegúrese de que los largueros han sido correctamente colocados.
- 6.- Ahora puede seleccionar las diferentes alturas a las cuales colocará los ganchos y largueros de los estantes (figura 4).
- 7.- Antes de colocar las parrillas plásticas, asegúrese de que todos los largueros se encuentran correctamente colocados.
- 8.- Montaje guía ángulo:
  - a.- Retire todas las parrillas plásticas y extraiga uno de los largueros de la estantería.
  - b.- Introduzca 2 ganchos de ángulo en la barra ángulo tal y como muestra la figura (figura 6 y 7).  
NOTA: deberá emplear tantas barras ángulo como estantes disponga (figura 5).
  - c.- Introduzca el larguero por la barra ángulo con los ganchos laterales (figura 8).
  - d.- Ahora coloque el larguero con las barras ángulo en su anterior ubicación. Realice el mismo proceso con todos los largueros de uno de los laterales.
  - e.- Una vez terminado, asegúrese de colocar todas las barras ángulo contra el mismo extremo, ahora realice el montaje de los 2 largueros de la parte inferior (figura 9).
  - f.- Coloque en el nuevo soporte lateral 2 ganchos a la misma altura que la estantería ya montada.
  - g.- Monte el nuevo soporte lateral a los largueros que forman el ángulo (figura 9); asegúrese de introducirlos correctamente.
  - h.- Ahora ya puede montar el resto de largueros hasta finalizar el montaje.
  - i.- Antes de colocar las parrillas plásticas, asegúrese de que todos los largueros se encuentran correctamente colocados  
NOTA: las patas pueden regularse en altura 1 cm para absorber irregularidades del suelo, emplee una llave inglesa o fija de 17 mm

## Mounting instructions

The LACOR shelves do not need any tool whatsoever to be assembled or dismantled. Follow these instructions to be able to assemble one single shelf. If you need any further explanation or information, do not hesitate to contact your supplier or visit our website.

- 1.- Take all the components out of their original wrapping. Do not throw the wrapping away until you have checked that the article is complete.  
Place all the components on the floor.
- 2.- Make a space available that is much larger than the shelf to be assembled.
- 3.- Take a side support lying on the floor and put two hooks into the lowest holes you are going to use, as shown in figure 1. Lean this support against the wall.
- 4.- Take the other side support and put the hooks into the same holes. Now place the 2 lower rods (figure 2).
- 5.- Stand this side support up and bring it next to the side support leaning against the wall. Put the rod lengths into its hooks. The shelf will remain stabilized (figure 3).  
Make sure the rod lengths have been properly placed.
- 6.- Now you can select the different heights at which you will place the hooks and the shelf rod lengths (figure 4).
- 7.- Before placing the plastic racks, make sure that all the rods are properly in place.
- 8.- Assembly of angle guide rail:
  - a.- Remove all the plastic racks and take out one of the shelf rod lengths.
  - b.- Put 2 angle hooks into the angle bar as shown (figure 6 and Figure 7).  
NOTE: you must use as many angle bars as the number of shelves you have (figure 5).
  - c.- Put the rod length through the angle bar with the side hooks (figure 8).
  - d.- Now place the rod length with the angle bars in its previous place. Follow the same process with all the rod lengths of one of the sides.
  - e.- Once finished, make sure you place all the angle bars against the same end. Now assemble the 2 lower rod lengths (figure 9).
  - f.- Place 2 hooks on the new side support at the same height as the shelf assembled.
  - g.- Mount the new side support onto the rod lengths that form the angle (figure 9). Make sure you introduce them properly.
  - h.- Now you can assemble the rest of the rod lengths until you finish the assembly.
  - i.- Before placing the plastic racks, make sure that all the rod lengths are properly placed.  
NOTE: the legs can be adjusted by 1 cm in height to absorb uneven-nesses in the floor. Use an adjustable or 17 mm fixed spanner.

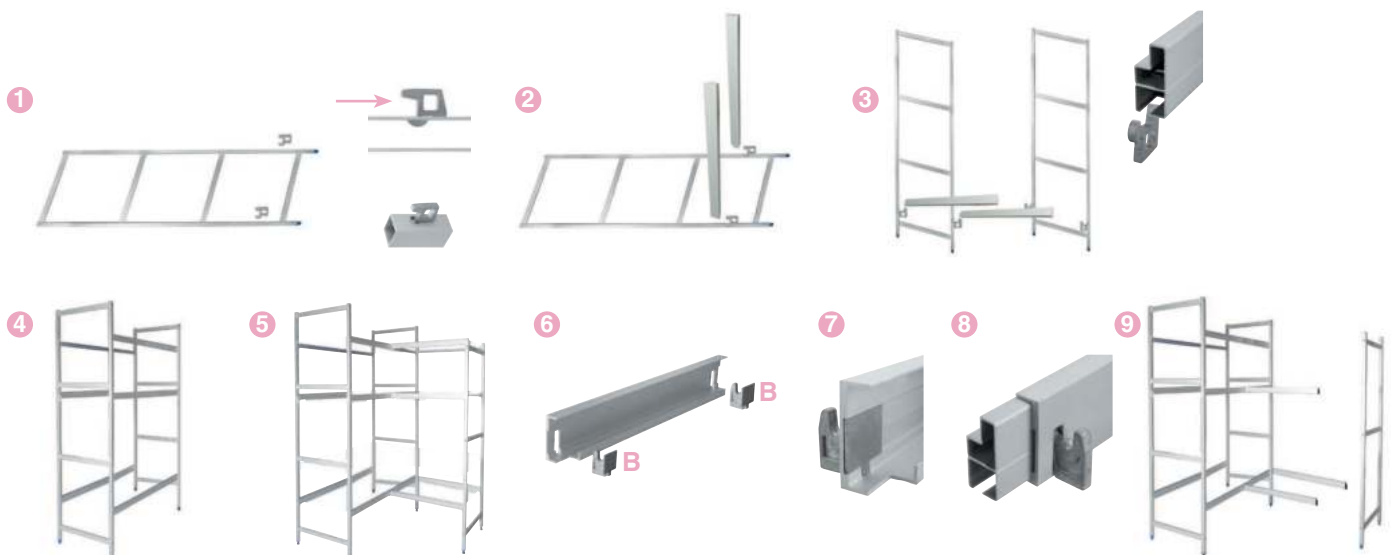

## AL

Aluminium

### SopORTE lateral

Support latérale  
Seitenständer  
Lateral support  
Suporte latera

#### 385 mm (GN 2/3)

Fondo / Width

Ref	€	h (mm)
56302	32,40	250
56317	88,70	1750
56320	103,70	2000

#### 560 mm (GN 1/1)

Fondo / Width

Ref	€
57302	36,40
57317	96,00
57320	110,80

10 estantes (máx) · 10 shelves (max)

12 estantes (máx) · 12 shelves (max)



## PP AL

Polypropilene Aluminium

### Estante completo

Étahère compléte  
Regal-Set  
Shelf set  
Prateleira completo

#### 385 mm (GN 2/3)

Fondo / Width

Ref	€	L (mm)
56007	46,50	710
56008	49,40	820
56009	54,80	930
56010	62,80	1035
56011	67,90	1145
56012	72,00	1255
56013	74,60	1365
56014	84,70	1470
56015	87,10	1580

#### 560 mm (GN 1/1)

Fondo / Width

Ref	€	U.Venta
57007	54,80	1
57008	57,80	1
57009	62,80	1
57010	74,60	1
57011	79,50	1
57012	84,70	1
57013	89,50	1
57014	98,80	1
57015	104,40	1

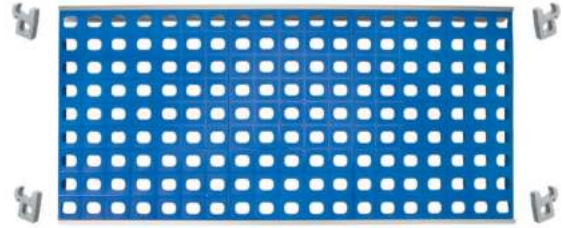

## AL

Aluminium

### Set ángulo 90°

Jeu angle 90°  
Eckesatz 90°  
90° corner set  
Conjunto ángulo 90°



Ref	€	L (mm)	U.Venta
56330	15,30	385	1
57330	19,60	560	1

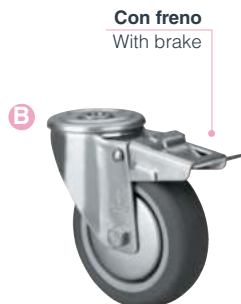

Con freno  
With brake

### Rueda para estantería

Roue pour étagère  
Rad für Regal  
Shelf wheel  
Roda para prateleira

	Ref	€	U.Venta
A	56522	45,30	1
B	56523	61,50	1



## Repuestos

Pièces détachées · Ersatzteile · Spares · Sobresselentes

### AL

Aluminium

#### Barra soporte lateral

Barre support latérale  
Seitenständer stange  
Lateral support bar  
Barra soporte lateral

Ref	€	h (mm)	U.Venta
56502	9,10	250	1
56517	32,20	1750	1
56520	35,40	2000	1

#### Travesaño · Crossbar



Barra · Bar

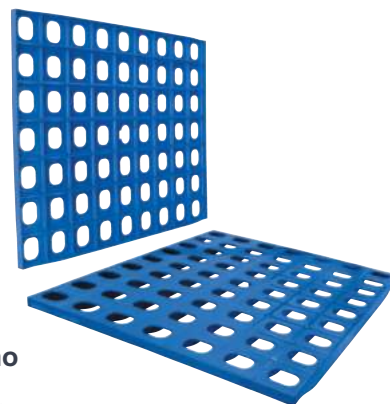

### PP

Polypropilene

#### Parrilla polietileno

Clayete en polyéthilène  
Polyethylen Boden/Raster  
Polyethylene rack  
Grelha polietileno

Ref	€	mm	U.Venta
56325	7,20	353x325	1
56435	8,30	353x425	3
57325	11,10	530x325	1
57435	13,60	530x435	1

### AL

Aluminium

#### Travesaño soporte lateral

Longeron support latérale  
Seitenständer traverse  
Lateral support crossbar  
Travesaño soporte lateral

Ref	€	L (mm)	U.Venta
56321	5,40	385	1
57321	8,00	560	1

### AL

Aluminium

#### Travesaño

Longeron  
Traverse  
Crossbar  
Travesano



Ref	€	L (mm)	U.Venta
56507	14,10	654	1
56508	15,00	766	1
56509	17,20	876	1
56510	18,80	981	1
56511	20,30	1091	1
56512	21,80	1201	1
56513	23,20	1311	1
56514	24,70	1416	1
56515	25,60	1526	1

### AL

Aluminium

#### Set angulo 90°

Jeu angle 90°  
Eckesatz 90°  
90° corner set  
Conjunto ángulo 90°

Ref	€	L (mm)	U.Venta
56322	14,30	385	1
57322	18,50	560	1

### AL

Aluminium

#### Jgo. 4 ganchos travesaño

Jeu 4 crochet pour longeron  
4 Satz Haken für traverse  
4 pcs. crossbar hooks  
Jogo 4 ganchos travesano

Ref	€	U.Venta
56524	3,00	1

### AL

Aluminium

#### Jgo. 4 ganchos ángulo

Jeu 4 crochet pour langle  
4 Satz Haken für ecke  
4 pcs. set corner hooks  
Jogo 4 ganchos ángulo

Ref	€	U.Venta
56527	2,40	1



### Inox 18/10

#### Jgo. 6 tornillos

Jeu 6 vis en Inox  
6 Satz schrauben  
6 pcs. set screws  
Jogo 6 parafusos

Ref	€	U.Venta
56526	2,20	1



### PP

Polypropilene

#### Jgo. 2 pie nivelación

Jeu 2 pied nivellement  
2 Satz niveau füsse  
26 pcs. set level foot  
2 jogo pé nivelamento

Ref	€	U.Venta
56525	4,80	1



Fondo · Width: 385 mm  
 Altura · Height: 250 mm



### Bancada completa

Banc complet  
 Bank, komplett  
 Full bench  
 Banco completo

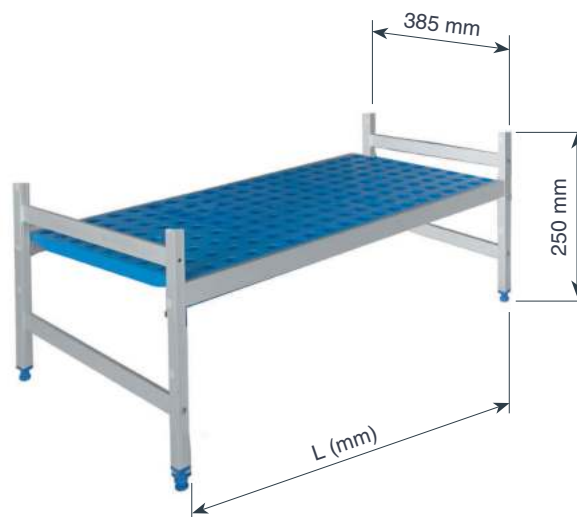

#### 1 Estante · Shelf

L (mm)	Ref	€	Desglose / Breakdown
710	55400	112,50	56302 x 2 / 56007 x 1
822	55401	115,00	56302 x 2 / 56008 x 1
932	55402	120,00	56302 x 2 / 56009 x 1
1037	55403	127,50	56302 x 2 / 56010 x 1
1147	55404	132,60	56302 x 2 / 56011 x 1
1257	55405	136,80	56302 x 2 / 56012 x 1
1367	55406	139,20	56302 x 2 / 56013 x 1
1472	55407	149,30	56302 x 2 / 56014 x 1
1582	55408	151,70	56302 x 2 / 56015 x 1

Fondo · Width: 560 mm  
 Altura · Height: 250 mm



### Bancada completa

Banc complet  
 Bank, komplett  
 Full bench  
 Banco completo

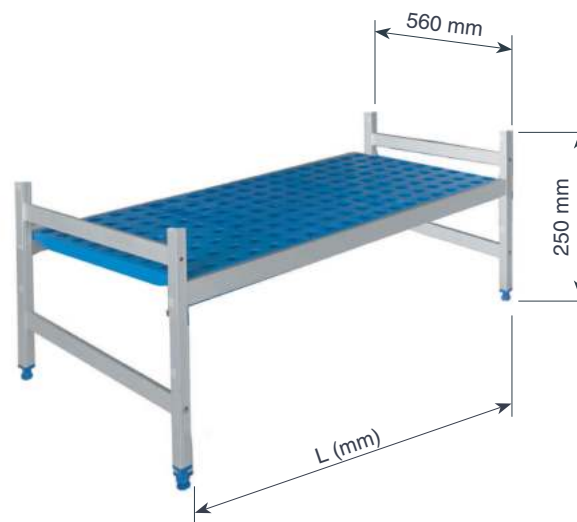

#### 1 Estante · Shelf

L (mm)	Ref	€	Desglose / Breakdown
710	55700	127,90	57302 x 2 / 57007 x 1
822	55701	130,50	57302 x 2 / 57008 x 1
932	55702	135,50	57302 x 2 / 57009 x 1
1037	55703	147,30	57302 x 2 / 57010 x 1
1147	55704	152,30	57302 x 2 / 57011 x 1
1257	55705	157,40	57302 x 2 / 57012 x 1
1367	55706	162,00	57302 x 2 / 57013 x 1
1472	55707	172,10	57302 x 2 / 57014 x 1
1582	55708	176,90	57302 x 2 / 57015 x 1

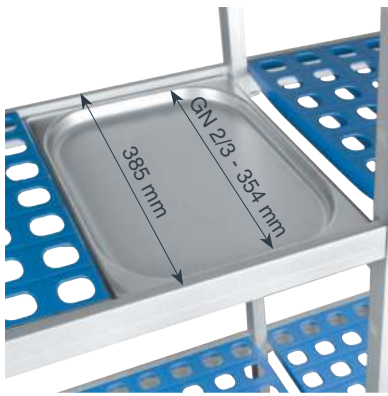

Fondo · Width: 385 mm  
 Altura · Height: 1.750 mm



### Estantería completa

Rayonnage complet  
 Volle Regale  
 Full shelving  
 Estantes completa



SIMPLE

#### 3 Estantes · Shelf

L (mm)	Ref	€	Desglose · Breakdown
710	55409	320,50	56317 x 2 + 56007 x 3
822	55410	328,30	56317 x 2 + 56008 x 3
932	55411	343,40	56317 x 2 + 56009 x 3
1037	55412	365,80	56317 x 2 + 56010 x 3
1147	55413	379,80	56317 x 2 + 56011 x 3
1257	55414	393,90	56317 x 2 + 56012 x 3
1367	55415	400,50	56317 x 2 + 56013 x 3
1472	55416	431,20	56317 x 2 + 56014 x 3
1582	55417	437,50	56317 x 2 + 56015 x 3

DOBLE · DOUBLE

#### 4 Estantes · Shelf

Ref	€	Desglose · Breakdown
55446	367,40	56317 x 2 + 56007 x 4
55447	378,80	56317 x 2 + 56008 x 4
55448	397,50	56317 x 2 + 56009 x 4
55449	427,90	56317 x 2 + 56010 x 4
55450	448,30	56317 x 2 + 56011 x 4
55451	465,90	56317 x 2 + 56012 x 4
55452	475,80	56317 x 2 + 56013 x 4
55453	515,80	56317 x 2 + 56014 x 4
55454	525,80	56317 x 2 + 56015 x 4

#### 5 Estantes · Shelf

Ref	€	Desglose · Breakdown
55483	415,50	56317 x 2 + 56007 x 5
55484	427,90	56317 x 2 + 56008 x 5
55485	453,70	56317 x 2 + 56009 x 5
55486	491,40	56317 x 2 + 56010 x 5
55487	516,80	56317 x 2 + 56011 x 5
55488	538,10	56317 x 2 + 56012 x 5
55489	539,60	56317 x 2 + 56013 x 5
55490	588,70	56317 x 2 + 56014 x 5
55491	600,90	56317 x 2 + 56015 x 5

TRIPLE

L (mm)	Ref	€	Desglose · Breakdown
1719	55418	597,80	56317 x 3 + 56007 x 3 + 56010 x 3
1829	55419	613,10	56317 x 3 + 56007 x 3 + 56011 x 3
1939	55420	625,80	56317 x 3 + 56007 x 3 + 56012 x 3
2046	55421	643,30	56317 x 2 + 56010 x 6
2154	55422	663,30	56317 x 3 + 56007 x 3 + 56014 x 3
2264	55423	670,80	56317 x 3 + 56007 x 3 + 56015 x 3
2376	55424	678,30	56317 x 3 + 56010 x 3 + 56013 x 3
2481	55425	708,50	56317 x 3 + 56010 x 3 + 56014 x 3
2591	55426	715,90	56317 x 3 + 56010 x 3 + 56015 x 3
2701	55427	731,00	56317 x 3 + 56011 x 3 + 56015 x 3
2811	55428	743,80	56317 x 3 + 56013 x 3 + 56014 x 3
2916	55429	773,30	56317 x 2 + 56014 x 6
3026	55430	780,20	56317 x 3 + 56014 x 3 + 56015 x 3
3136	55431	788,60	56317 x 3 + 56015 x 6

Ref	€	Desglose · Breakdown
55455	708,40	56317 x 3 + 56007 x 4 + 56010 x 4
55456	728,00	56317 x 3 + 56007 x 4 + 56011 x 4
55457	744,70	56317 x 3 + 56007 x 4 + 56012 x 4
55458	768,60	56317 x 3 + 56010 x 8
55459	795,50	56317 x 3 + 56007 x 4 + 56014 x 4
55460	804,80	56317 x 3 + 56007 x 4 + 56015 x 4
55461	815,60	56317 x 3 + 56010 x 4 + 56013 x 4
55462	855,90	56317 x 3 + 56010 x 4 + 56014 x 4
55463	865,20	56317 x 3 + 56010 x 4 + 56015 x 4
55464	886,00	56317 x 3 + 56011 x 4 + 56015 x 4
55465	903,00	56317 x 3 + 56013 x 4 + 56014 x 4
55466	943,00	56317 x 3 + 56014 x 8
55467	952,80	56317 x 3 + 56014 x 4 + 56015 x 4
55468	963,00	56317 x 3 + 56015 x 8

Ref	€	Desglose · Breakdown
55492	818,80	56317 x 3 + 56007 x 5 + 56010 x 5
55493	844,20	56317 x 3 + 56007 x 5 + 56011 x 5
55494	865,30	56317 x 3 + 56007 x 5 + 56012 x 5
55495	894,30	56317 x 3 + 56010 x 10
55496	927,70	56317 x 3 + 56007 x 5 + 56014 x 5
55497	940,10	56317 x 3 + 56007 x 5 + 56015 x 5
55498	953,10	56317 x 3 + 56010 x 5 + 56013 x 5
55499	1.003,30	56317 x 3 + 56010 x 5 + 56014 x 5
55500	1.015,70	56317 x 3 + 56010 x 5 + 56015 x 5
55501	1.040,90	56317 x 3 + 56011 x 5 + 56015 x 5
55502	1.062,10	56317 x 3 + 56013 x 5 + 56014 x 5
55503	1.112,00	56317 x 3 + 56014 x 10
55504	1.124,50	56317 x 3 + 56014 x 5 + 56015 x 5
55505	1.136,90	56317 x 3 + 56015 x 10

L (mm)	Ref	€	Desglose · Breakdown
3275	55432	947,90	56317 x 4 + 56010 x 6 + 56012 x 3
3385	55433	955,40	56317 x 4 + 56010 x 6 + 56013 x 3
3490	55434	985,50	56317 x 4 + 56010 x 6 + 56014 x 3
3598	55435	1.005,60	56317 x 4 + 56007 x 3 + 56014 x 6
3710	55436	1.016,00	56317 x 4 + 56011 x 6 + 56014 x 3
3818	55437	1.020,40	56317 x 4 + 56007 x 3 + 56015 x 6
3925	55438	1.050,90	56317 x 4 + 56010 x 3 + 56014 x 6
4035	55439	1.066,20	56317 x 4 + 56011 x 3 + 56014 x 6
4145	55440	1.069,90	56317 x 4 + 56010 x 3 + 56015 x 6
4255	55441	1.080,90	56317 x 4 + 56011 x 3 + 56015 x 6
4360	55442	1.116,40	56317 x 4 + 56014 x 9
4470	55443	1.123,80	56317 x 4 + 56014 x 6 + 56015 x 3
4580	55444	1.131,00	56317 x 4 + 56014 x 3 + 56015 x 6
4690	55445	1.138,60	56317 x 4 + 56015 x 9

Ref	€	Desglose · Breakdown
55469	1.145,90	56317 x 4 + 56010 x 8 + 56012 x 4
55470	1.155,80	56317 x 4 + 56010 x 8 + 56013 x 4
55471	1.195,80	56317 x 4 + 56010 x 8 + 56014 x 4
55472	1.222,50	56317 x 4 + 56007 x 4 + 56014 x 8
55473	1.236,20	56317 x 4 + 56011 x 8 + 56014 x 4
55474	1.242,30	56317 x 4 + 56007 x 4 + 56015 x 8
55475	1.283,20	56317 x 4 + 56010 x 4 + 56014 x 8
55476	1.309,60	56317 x 4 + 56011 x 4 + 56014 x 8
55477	1.316,20	56317 x 4 + 56010 x 4 + 56015 x 8
55478	1.323,10	56317 x 4 + 56011 x 4 + 56015 x 8
55479	1.370,10	56317 x 4 + 56014 x 12
55480	1.380,00	56317 x 4 + 56014 x 8 + 56015 x 4
55481	1.389,90	56317 x 4 + 56014 x 4 + 56015 x 8
55482	1.399,70	56317 x 4 + 56015 x 12

Ref	€	Desglose · Breakdown
55506	1.343,50	56317 x 4 + 56010 x 10 + 56012 x 5
55507	1.356,00	56317 x 4 + 56010 x 10 + 56013 x 5
55508	1.405,90	56317 x 4 + 56010 x 10 + 56014 x 5
55509	1.439,70	56317 x 4 + 56007 x 5 + 56014 x 10
55510	1.456,60	56317 x 4 + 56011 x 10 + 56014 x 5
55511	1.464,10	56317 x 4 + 56007 x 5 + 56015 x 10
55512	1.515,00	56317 x 4 + 56010 x 5 + 56014 x 10
55513	1.540,30	56317 x 4 + 56011 x 5 + 56014 x 10
55514	1.549,40	56317 x 4 + 56010 x 5 + 56015 x 10
55515	1.565,00	56317 x 4 + 56011 x 5 + 56015 x 10
55516	1.624,00	56317 x 4 + 56014 x 15
55517	1.636,40	56317 x 4 + 56014 x 10 + 56015 x 5
55518	1.648,90	56317 x 4 + 56014 x 5 + 56015 x 10
55519	1.661,20	56317 x 4 + 56015 x 15

Transporte-Estanterías  
 transport - Shelves



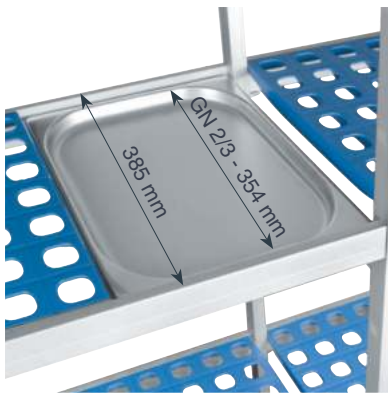

Fondo · Width: 385 mm  
 Altura · Height: 2.000 mm

**PP** **AL** **75°C**  
 Polypropilene Aluminium -30°C 

### Estantería completa

Rayonnage complet  
 Regale, komplett  
 Full shelving  
 Estantes completa

#### 3 Estantes · Shelf

L (mm)	Ref	€	Desglose · Breakdown
710	55520	350,40	56320 x 2 + 56007 x 3
822	55521	357,90	56320 x 2 + 56008 x 3
932	55522	371,60	56320 x 2 + 56009 x 3
1037	55523	394,80	56320 x 2 + 56010 x 3
1147	55524	410,60	56320 x 2 + 56011 x 3
1257	55525	423,50	56320 x 2 + 56012 x 3
1367	55526	430,80	56320 x 2 + 56013 x 3
1472	55527	460,80	56320 x 2 + 56014 x 3
1582	55528	468,20	56320 x 2 + 56015 x 3

#### 4 Estantes · Shelf

Ref	€	Desglose · Breakdown
55557	397,90	56320 x 2 + 56007 x 4
55558	408,30	56320 x 2 + 56008 x 4
55559	428,20	56320 x 2 + 56009 x 4
55560	458,20	56320 x 2 + 56010 x 4
55561	478,60	56320 x 2 + 56011 x 4
55562	495,40	56320 x 2 + 56012 x 4
55563	505,50	56320 x 2 + 56013 x 4
55564	545,50	56320 x 2 + 56014 x 4
55565	555,20	56320 x 2 + 56015 x 4

#### 5 Estantes · Shelf

Ref	€	Desglose · Breakdown
55594	445,60	56320 x 2 + 56007 x 5
55595	458,60	56320 x 2 + 56008 x 5
55596	483,40	56320 x 2 + 56009 x 5
55597	520,90	56320 x 2 + 56010 x 5
55598	546,50	56320 x 2 + 56011 x 5
55599	567,60	56320 x 2 + 56012 x 5
55600	580,00	56320 x 2 + 56013 x 5
55601	630,00	56320 x 2 + 56014 x 5
55602	642,40	56320 x 2 + 56015 x 5

SIMPLE

L (mm)	Ref	€	Desglose · Breakdown
1719	55529	641,90	56320 x 3 + 56007 x 3 + 56010 x 3
1829	55530	657,50	56320 x 3 + 56007 x 3 + 56011 x 3
1939	55531	670,30	56320 x 3 + 56007 x 3 + 56012 x 3
2046	55532	687,30	56320 x 2 + 56010 x 6
2154	55533	707,60	56320 x 3 + 56007 x 3 + 56014 x 3
2264	55534	714,90	56320 x 3 + 56007 x 3 + 56015 x 3
2376	55535	722,80	56320 x 3 + 56010 x 3 + 56013 x 3
2481	55536	752,80	56320 x 3 + 56010 x 3 + 56014 x 3
2591	55537	760,10	56320 x 3 + 56010 x 3 + 56015 x 3
2701	55538	775,50	56320 x 3 + 56011 x 3 + 56015 x 3
2811	55539	787,10	56320 x 3 + 56013 x 3 + 56014 x 3
2916	55540	817,30	56320 x 2 + 56014 x 6
3026	55541	825,70	56320 x 3 + 56014 x 3 + 56015 x 3
3136	55542	833,00	56320 x 3 + 56015 x 6

DOBLE · DOUBLE

Ref	€	Desglose · Breakdown
55566	752,70	56320 x 3 + 56007 x 4 + 56010 x 4
55567	772,10	56320 x 3 + 56007 x 4 + 56011 x 4
55568	790,00	56320 x 3 + 56007 x 4 + 56012 x 4
55569	813,10	56320 x 3 + 56010 x 8
55570	839,90	56320 x 3 + 56007 x 4 + 56014 x 4
55571	848,90	56320 x 3 + 56007 x 4 + 56015 x 4
55572	859,80	56320 x 3 + 56010 x 4 + 56013 x 4
55573	900,30	56320 x 3 + 56010 x 4 + 56014 x 4
55574	910,00	56320 x 3 + 56010 x 4 + 56015 x 4
55575	930,50	56320 x 3 + 56011 x 4 + 56015 x 4
55576	947,30	56320 x 3 + 56013 x 4 + 56014 x 4
55577	987,30	56320 x 3 + 56014 x 8
55578	997,40	56320 x 3 + 56014 x 4 + 56015 x 4
55579	1.007,10	56320 x 3 + 56015 x 8

Ref	€	Desglose · Breakdown
55603	863,20	56320 x 3 + 56007 x 5 + 56010 x 5
55604	888,50	56320 x 3 + 56007 x 5 + 56011 x 5
55605	909,80	56320 x 3 + 56007 x 5 + 56012 x 5
55606	938,70	56320 x 3 + 56010 x 10
55607	972,20	56320 x 3 + 56007 x 5 + 56014 x 5
55608	984,50	56320 x 3 + 56007 x 5 + 56015 x 5
55609	997,60	56320 x 3 + 56010 x 5 + 56013 x 5
55610	1.047,70	56320 x 3 + 56010 x 5 + 56014 x 5
55611	1.060,00	56320 x 3 + 56010 x 5 + 56015 x 5
55612	1.085,30	56320 x 3 + 56011 x 5 + 56015 x 5
55613	1.106,60	56320 x 3 + 56013 x 5 + 56014 x 5
55614	1.156,70	56320 x 3 + 56014 x 10
55615	1.169,10	56320 x 3 + 56014 x 5 + 56015 x 5
55616	1.181,20	56320 x 3 + 56015 x 10

TRIPLE

L (mm)	Ref	€	Desglose · Breakdown
3275	55543	1.007,20	56320 x 4 + 56010 x 6 + 56012 x 3
3385	55544	1.014,70	56320 x 4 + 56010 x 6 + 56013 x 3
3490	55545	1.044,80	56320 x 4 + 56010 x 6 + 56014 x 3
3598	55546	1.065,00	56320 x 4 + 56007 x 3 + 56014 x 6
3710	55547	1.075,20	56320 x 4 + 56011 x 6 + 56014 x 3
3818	55548	1.079,60	56320 x 4 + 56007 x 3 + 56015 x 6
3925	55549	1.110,30	56320 x 4 + 56010 x 3 + 56014 x 6
4035	55550	1.125,20	56320 x 4 + 56011 x 3 + 56014 x 6
4145	55551	1.124,80	56320 x 4 + 56010 x 3 + 56015 x 6
4255	55552	1.140,20	56320 x 4 + 56011 x 3 + 56015 x 6
4360	55553	1.175,60	56320 x 4 + 56014 x 9
4470	55554	1.183,10	56320 x 4 + 56014 x 6 + 56015 x 3
4580	55555	1.190,40	56320 x 4 + 56014 x 3 + 56015 x 6
4690	55556	1.197,80	56320 x 4 + 56015 x 9

Ref	€	Desglose · Breakdown
55580	1.205,10	56320 x 4 + 56010 x 8 + 56012 x 4
55581	1.215,00	56320 x 4 + 56010 x 8 + 56013 x 4
55582	1.255,00	56320 x 4 + 56010 x 8 + 56014 x 4
55583	1.281,70	56320 x 4 + 56007 x 4 + 56014 x 8
55584	1.295,60	56320 x 4 + 56011 x 8 + 56014 x 4
55585	1.301,60	56320 x 4 + 56007 x 4 + 56015 x 8
55586	1.342,30	56320 x 4 + 56010 x 4 + 56014 x 8
55587	1.362,50	56320 x 4 + 56011 x 4 + 56014 x 8
55588	1.362,10	56320 x 4 + 56010 x 4 + 56015 x 8
55589	1.382,20	56320 x 4 + 56011 x 4 + 56015 x 8
55590	1.428,90	56320 x 4 + 56014 x 12
55591	1.438,40	56320 x 4 + 56014 x 8 + 56015 x 4
55592	1.449,20	56320 x 4 + 56014 x 4 + 56015 x 8
55593	1.459,10	56320 x 4 + 56015 x 12

Ref	€	Desglose · Breakdown
55617	1.402,80	56320 x 4 + 56010 x 10 + 56012 x 5
55618	1.415,20	56320 x 4 + 56010 x 10 + 56013 x 5
55619	1.465,30	56320 x 4 + 56010 x 10 + 56014 x 5
55620	1.498,80	56320 x 4 + 56007 x 5 + 56014 x 10
55621	1.516,00	56320 x 4 + 56011 x 10 + 56014 x 5
55622	1.523,40	56320 x 4 + 56007 x 5 + 56015 x 10
55623	1.574,10	56320 x 4 + 56010 x 5 + 56014 x 10
55624	1.599,50	56320 x 4 + 56011 x 5 + 56014 x 10
55625	1.598,90	56320 x 4 + 56010 x 5 + 56015 x 10
55626	1.624,20	56320 x 4 + 56011 x 5 + 56015 x 10
55627	1.683,20	56320 x 4 + 56014 x 15
55628	1.695,60	56320 x 4 + 56014 x 10 + 56015 x 5
55629	1.708,00	56320 x 4 + 56014 x 5 + 56015 x 10
55630	1.720,20	56320 x 4 + 56015 x 15

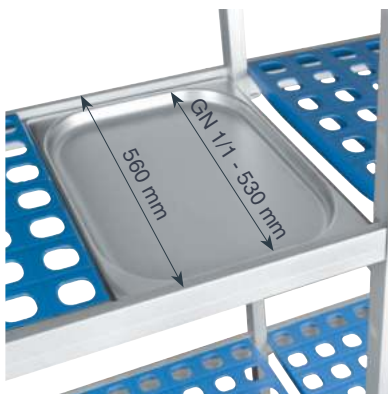

Fondo · Width: 560 mm  
 Altura · Height: 1.750 mm

**PP AL 75°C -30°C**  
 Polypropilene Aluminium BPA free

### Estantería completa

Rayonnage complet  
 Regale, komplett  
 Full shelving  
 Estantes completa

#### 3 Estantes · Shelf

#### 4 Estantes · Shelf

#### 5 Estantes · Shelf

SIMPLE

DOBLE · DOUBLE

TRIPLE

L (mm)	Ref	€	Desglose · Breakdown
710	55709	357,90	57317 x 2 + 57007 x 3
822	55710	365,50	57317 x 2 + 57008 x 3
932	55711	379,80	57317 x 2 + 57009 x 3
1037	55712	415,50	57317 x 2 + 57010 x 3
1147	55713	431,20	57317 x 2 + 57011 x 3
1257	55714	446,00	57317 x 2 + 57012 x 3
1367	55715	460,80	57317 x 2 + 57013 x 3
1472	55716	490,90	57317 x 2 + 57014 x 3
1582	55717	505,70	57317 x 2 + 57015 x 3

Ref	€	Desglose · Breakdown
55746	412,70	57317 x 2 + 57007 x 4
55747	422,20	57317 x 2 + 57008 x 4
55748	443,00	57317 x 2 + 57009 x 4
55749	490,70	57317 x 2 + 57010 x 4
55750	511,00	57317 x 2 + 57011 x 4
55751	530,70	57317 x 2 + 57012 x 4
55752	550,50	57317 x 2 + 57013 x 4
55753	590,30	57317 x 2 + 57014 x 4
55754	610,10	57317 x 2 + 57015 x 4

Ref	€	Desglose · Breakdown
55783	468,60	57317 x 2 + 57007 x 5
55784	480,90	57317 x 2 + 57008 x 5
55785	506,30	57317 x 2 + 57009 x 5
55786	565,20	57317 x 2 + 57010 x 5
55787	590,50	57317 x 2 + 57011 x 5
55788	615,20	57317 x 2 + 57012 x 5
55789	639,90	57317 x 2 + 57013 x 5
55790	690,10	57317 x 2 + 57014 x 5
55791	714,40	57317 x 2 + 57015 x 5

L (mm)	Ref	€	Desglose · Breakdown
1719	55718	677,90	57317 x 3 + 57007 x 3 + 57010 x 3
1829	55719	693,10	57317 x 3 + 57007 x 3 + 57011 x 3
1939	55720	707,60	57317 x 3 + 57007 x 3 + 57012 x 3
2046	55721	735,00	57317 x 3 + 57010 x 6
2154	55722	752,80	57317 x 3 + 57007 x 3 + 57014 x 3
2264	55723	766,40	57317 x 3 + 57007 x 3 + 57015 x 3
2376	55724	780,80	57317 x 3 + 57010 x 3 + 57013 x 3
2481	55725	810,40	57317 x 3 + 57010 x 3 + 57014 x 3
2591	55726	825,70	57317 x 3 + 57010 x 3 + 57015 x 3
2701	55727	840,50	57317 x 3 + 57011 x 3 + 57015 x 3
2811	55728	855,70	57317 x 3 + 57013 x 3 + 57014 x 3
2916	55729	885,60	57317 x 3 + 57014 x 6
3026	55730	900,50	57317 x 3 + 57014 x 3 + 57015 x 3
3136	55731	915,30	57317 x 3 + 57015 x 6

Ref	€	Desglose · Breakdown
55755	807,80	57317 x 3 + 57007 x 4 + 57010 x 4
55756	827,90	57317 x 3 + 57007 x 4 + 57011 x 4
55757	847,30	57317 x 3 + 57007 x 4 + 57012 x 4
55758	885,20	57317 x 3 + 57010 x 8
55759	907,70	57317 x 3 + 57007 x 4 + 57014 x 4
55760	927,40	57317 x 3 + 57007 x 4 + 57015 x 4
55761	945,10	57317 x 3 + 57010 x 4 + 57013 x 4
55762	985,00	57317 x 3 + 57010 x 4 + 57014 x 4
55763	1.004,70	57317 x 3 + 57010 x 4 + 57015 x 4
55764	1.024,90	57317 x 3 + 57011 x 4 + 57015 x 4
55765	1.044,80	57317 x 3 + 57013 x 4 + 57014 x 4
55766	1.084,70	57317 x 3 + 57014 x 8
55767	1.104,60	57317 x 3 + 57014 x 4 + 57015 x 4
55768	1.124,20	57317 x 3 + 57015 x 8

Ref	€	Desglose · Breakdown
55792	937,80	57317 x 3 + 57007 x 5 + 57010 x 5
55793	963,20	57317 x 3 + 57007 x 5 + 57011 x 5
55794	987,50	57317 x 3 + 57007 x 5 + 57012 x 5
55795	1.034,20	57317 x 3 + 57010 x 10
55796	1.062,30	57317 x 3 + 57007 x 5 + 57014 x 5
55797	1.087,10	57317 x 3 + 57007 x 5 + 57015 x 5
55798	1.109,20	57317 x 3 + 57010 x 5 + 57013 x 5
55799	1.159,20	57317 x 3 + 57010 x 5 + 57014 x 5
55800	1.183,70	57317 x 3 + 57010 x 5 + 57015 x 5
55801	1.209,30	57317 x 3 + 57011 x 5 + 57015 x 5
55802	1.233,80	57317 x 3 + 57013 x 5 + 57014 x 5
55803	1.284,10	57317 x 3 + 57014 x 10
55804	1.308,70	57317 x 3 + 57014 x 5 + 57015 x 5
55805	1.333,20	57317 x 3 + 57015 x 10

L (mm)	Ref	€	Desglose · Breakdown
3275	55732	1.085,90	57317 x 4 + 57010 x 6 + 57012 x 3
3385	55733	1.100,60	57317 x 4 + 57010 x 6 + 57013 x 3
3490	55734	1.130,70	57317 x 4 + 57010 x 6 + 57014 x 3
3598	55735	1.147,60	57317 x 4 + 57007 x 3 + 57014 x 6
3710	55736	1.161,00	57317 x 4 + 57011 x 6 + 57014 x 3
3818	55737	1.177,30	57317 x 4 + 57007 x 3 + 57015 x 6
3925	55738	1.205,60	57317 x 4 + 57010 x 3 + 57014 x 6
4035	55739	1.220,80	57317 x 4 + 57011 x 3 + 57014 x 6
4145	55740	1.235,20	57317 x 4 + 57010 x 3 + 57015 x 6
4255	55741	1.250,50	57317 x 4 + 57011 x 3 + 57015 x 6
4360	55742	1.280,30	57317 x 4 + 57014 x 9
4470	55743	1.295,10	57317 x 4 + 57014 x 6 + 57015 x 3
4580	55744	1.310,40	57317 x 4 + 57014 x 3 + 57015 x 6
4690	55745	1.324,90	57317 x 4 + 57015 x 9

Ref	€	Desglose · Breakdown
55769	1.319,60	57317 x 4 + 57010 x 8 + 57012 x 4
55770	1.339,40	57317 x 4 + 57010 x 8 + 57013 x 4
55771	1.379,50	57317 x 4 + 57010 x 8 + 57014 x 4
55772	1.402,10	57317 x 4 + 57007 x 4 + 57014 x 8
55773	1.419,00	57317 x 4 + 57011 x 8 + 57014 x 4
55774	1.441,40	57317 x 4 + 57007 x 4 + 57015 x 8
55775	1.479,40	57317 x 4 + 57010 x 4 + 57014 x 8
55776	1.498,80	57317 x 4 + 57011 x 4 + 57014 x 8
55777	1.517,90	57317 x 4 + 57010 x 4 + 57015 x 8
55778	1.538,50	57317 x 4 + 57011 x 4 + 57015 x 8
55779	1.578,40	57317 x 4 + 57014 x 12
55780	1.598,90	57317 x 4 + 57014 x 8 + 57015 x 4
55781	1.618,10	57317 x 4 + 57014 x 4 + 57015 x 8
55782	1.638,20	57317 x 4 + 57015 x 12

Ref	€	Desglose · Breakdown
55806	1.552,30	57317 x 4 + 57010 x 10 + 57012 x 5
55807	1.576,80	57317 x 4 + 57010 x 10 + 57013 x 5
55808	1.627,50	57317 x 4 + 57010 x 10 + 57014 x 5
55809	1.655,30	57317 x 4 + 57007 x 5 + 57014 x 10
55810	1.678,30	57317 x 4 + 57011 x 10 + 57014 x 5
55811	1.704,50	57317 x 4 + 57007 x 5 + 57015 x 10
55812	1.752,40	57317 x 4 + 57010 x 5 + 57014 x 10
55813	1.777,00	57317 x 4 + 57011 x 5 + 57014 x 10
55814	1.802,30	57317 x 4 + 57010 x 5 + 57015 x 10
55815	1.827,90	57317 x 4 + 57011 x 5 + 57015 x 10
55816	1.877,90	57317 x 4 + 57014 x 15
55817	1.902,60	57317 x 4 + 57014 x 10 + 57015 x 5
55818	1.927,20	57317 x 4 + 57014 x 5 + 57015 x 10
55819	1.951,80	57317 x 4 + 57015 x 15

Transporte-Estanterías  
transport - Shelves

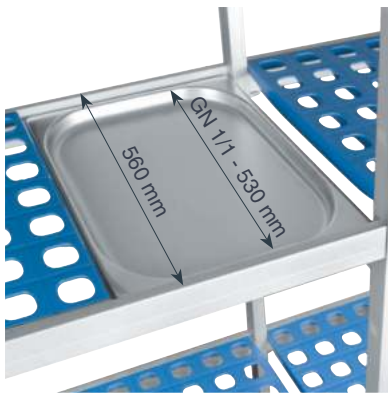

Fondo · Width: 560 mm  
 Altura · Height: 2.000 mm

**PP** **AL** **75°C** **-30°C**   
 Polypropilene Aluminium

### Estantería completa

Rayonnage complet  
 Regale, komplett  
 Full shelving  
 Estantes completa

SIMPLE

DOBLE · DOUBLE

TRIPLE

#### 3 Estantes · Shelf

#### 4 Estantes · Shelf

#### 5 Estantes · Shelf

L (mm)	Ref	€	Desglose · Breakdown
710	55820	387,80	57320 x 2 + 57007 x 3
822	55821	394,80	57320 x 2 + 57008 x 3
932	55822	410,30	57320 x 2 + 57009 x 3
1037	55823	445,60	57320 x 2 + 57010 x 3
1147	55824	460,80	57320 x 2 + 57011 x 3
1257	55825	475,70	57320 x 2 + 57012 x 3
1367	55826	490,50	57320 x 2 + 57013 x 3
1472	55827	520,50	57320 x 2 + 57014 x 3
1582	55828	535,40	57320 x 2 + 57015 x 3

Ref	€	Desglose · Breakdown
55857	443,00	57320 x 2 + 57007 x 4
55858	452,80	57320 x 2 + 57008 x 4
55859	472,90	57320 x 2 + 57009 x 4
55860	520,20	57320 x 2 + 57010 x 4
55861	540,50	57320 x 2 + 57011 x 4
55862	560,50	57320 x 2 + 57012 x 4
55863	580,00	57320 x 2 + 57013 x 4
55864	620,10	57320 x 2 + 57014 x 4
55865	639,80	57320 x 2 + 57015 x 4

Ref	€	Desglose · Breakdown
55894	498,10	57320 x 2 + 57007 x 5
55895	510,60	57320 x 2 + 57008 x 5
55896	535,80	57320 x 2 + 57009 x 5
55897	594,80	57320 x 2 + 57010 x 5
55898	620,20	57320 x 2 + 57011 x 5
55899	644,90	57320 x 2 + 57012 x 5
55900	669,70	57320 x 2 + 57013 x 5
55901	718,50	57320 x 2 + 57014 x 5
55902	743,10	57320 x 2 + 57015 x 5

L (mm)	Ref	€	Desglose · Breakdown
1719	55829	721,40	57320 x 3 + 57007 x 3 + 57010 x 3
1829	55830	737,60	57320 x 3 + 57007 x 3 + 57011 x 3
1939	55831	751,40	57320 x 3 + 57007 x 3 + 57012 x 3
2046	55832	780,30	57320 x 3 + 57010 x 6
2154	55833	797,30	57320 x 3 + 57007 x 3 + 57014 x 3
2264	55834	811,70	57320 x 3 + 57007 x 3 + 57015 x 3
2376	55835	824,00	57320 x 3 + 57010 x 3 + 57013 x 3
2481	55836	854,20	57320 x 3 + 57010 x 3 + 57014 x 3
2591	55837	870,10	57320 x 3 + 57010 x 3 + 57015 x 3
2701	55838	885,30	57320 x 3 + 57011 x 3 + 57015 x 3
2811	55839	900,10	57320 x 3 + 57013 x 3 + 57014 x 3
2916	55840	930,10	57320 x 3 + 57014 x 6
3026	55841	945,10	57320 x 3 + 57014 x 3 + 57015 x 3
3136	55842	959,70	57320 x 3 + 57015 x 6

Ref	€	Desglose · Breakdown
55866	852,20	57320 x 3 + 57007 x 4 + 57010 x 4
55867	872,10	57320 x 3 + 57007 x 4 + 57011 x 4
55868	891,30	57320 x 3 + 57007 x 4 + 57012 x 4
55869	929,50	57320 x 3 + 57010 x 8
55870	952,00	57320 x 3 + 57007 x 4 + 57014 x 4
55871	971,90	57320 x 3 + 57007 x 4 + 57015 x 4
55872	989,40	57320 x 3 + 57010 x 4 + 57013 x 4
55873	1.029,50	57320 x 3 + 57010 x 4 + 57014 x 4
55874	1.049,20	57320 x 3 + 57010 x 4 + 57015 x 4
55875	1.069,40	57320 x 3 + 57011 x 4 + 57015 x 4
55876	1.089,30	57320 x 3 + 57013 x 4 + 57014 x 4
55877	1.129,20	57320 x 3 + 57014 x 8
55878	1.149,00	57320 x 3 + 57014 x 4 + 57015 x 4
55879	1.168,90	57320 x 3 + 57015 x 8

Ref	€	Desglose · Breakdown
55903	982,40	57320 x 3 + 57007 x 5 + 57010 x 5
55904	1.007,30	57320 x 3 + 57007 x 5 + 57011 x 5
55905	1.032,10	57320 x 3 + 57007 x 5 + 57012 x 5
55906	1.078,80	57320 x 3 + 57010 x 10
55907	1.106,80	57320 x 3 + 57007 x 5 + 57014 x 5
55908	1.131,60	57320 x 3 + 57007 x 5 + 57015 x 5
55909	1.153,40	57320 x 3 + 57010 x 5 + 57013 x 5
55910	1.203,50	57320 x 3 + 57010 x 5 + 57014 x 5
55911	1.228,40	57320 x 3 + 57010 x 5 + 57015 x 5
55912	1.253,50	57320 x 3 + 57011 x 5 + 57015 x 5
55913	1.278,40	57320 x 3 + 57013 x 5 + 57014 x 5
55914	1.328,60	57320 x 3 + 57014 x 10
55915	1.353,00	57320 x 3 + 57014 x 5 + 57015 x 5
55916	1.377,60	57320 x 3 + 57015 x 10

L (mm)	Ref	€	Desglose · Breakdown
3275	55843	1.145,20	57320 x 4 + 57010 x 6 + 57012 x 3
3385	55844	1.159,90	57320 x 4 + 57010 x 6 + 57013 x 3
3490	55845	1.190,00	57320 x 4 + 57010 x 6 + 57014 x 3
3598	55846	1.206,80	57320 x 4 + 57007 x 3 + 57014 x 6
3710	55847	1.220,50	57320 x 4 + 57011 x 6 + 57014 x 3
3818	55848	1.236,60	57320 x 4 + 57007 x 3 + 57015 x 6
3925	55849	1.265,00	57320 x 4 + 57010 x 3 + 57014 x 6
4035	55850	1.280,00	57320 x 4 + 57011 x 3 + 57014 x 6
4145	55851	1.294,30	57320 x 4 + 57010 x 3 + 57015 x 6
4255	55852	1.309,90	57320 x 4 + 57011 x 3 + 57015 x 6
4360	55853	1.339,70	57320 x 4 + 57014 x 9
4470	55854	1.354,50	57320 x 4 + 57014 x 6 + 57015 x 3
4580	55855	1.369,40	57320 x 4 + 57014 x 3 + 57015 x 6
4690	55856	1.384,30	57320 x 4 + 57015 x 9

Ref	€	Desglose · Breakdown
55880	1.379,00	57320 x 4 + 57010 x 8 + 57012 x 4
55881	1.398,70	57320 x 4 + 57010 x 8 + 57013 x 4
55882	1.438,70	57320 x 4 + 57010 x 8 + 57014 x 4
55883	1.460,40	57320 x 4 + 57007 x 4 + 57014 x 8
55884	1.479,40	57320 x 4 + 57011 x 8 + 57014 x 4
55885	1.500,00	57320 x 4 + 57007 x 4 + 57015 x 8
55886	1.538,50	57320 x 4 + 57010 x 4 + 57014 x 8
55887	1.559,00	57320 x 4 + 57011 x 4 + 57014 x 8
55888	1.578,10	57320 x 4 + 57010 x 4 + 57015 x 8
55889	1.597,60	57320 x 4 + 57011 x 4 + 57015 x 8
55890	1.638,20	57320 x 4 + 57014 x 12
55891	1.658,10	57320 x 4 + 57014 x 8 + 57015 x 4
55892	1.676,90	57320 x 4 + 57014 x 4 + 57015 x 8
55893	1.697,60	57320 x 4 + 57015 x 12

Ref	€	Desglose · Breakdown
55917	1.612,60	57320 x 4 + 57010 x 10 + 57012 x 5
55918	1.637,30	57320 x 4 + 57010 x 10 + 57013 x 5
55919	1.686,60	57320 x 4 + 57010 x 10 + 57014 x 5
55920	1.715,30	57320 x 4 + 57007 x 5 + 57014 x 10
55921	1.737,40	57320 x 4 + 57011 x 10 + 57014 x 5
55922	1.764,60	57320 x 4 + 57007 x 5 + 57015 x 10
55923	1.812,10	57320 x 4 + 57010 x 5 + 57014 x 10
55924	1.837,60	57320 x 4 + 57011 x 5 + 57014 x 10
55925	1.861,60	57320 x 4 + 57010 x 5 + 57015 x 10
55926	1.886,90	57320 x 4 + 57011 x 5 + 57015 x 10
55927	1.937,20	57320 x 4 + 57014 x 15
55928	1.961,90	57320 x 4 + 57014 x 10 + 57015 x 5
55929	1.986,30	57320 x 4 + 57014 x 5 + 57015 x 10
55930	2.011,10	57320 x 4 + 57015 x 15

Fondo · Width: 385 mm  
 Altura · Height: 1.750 mm

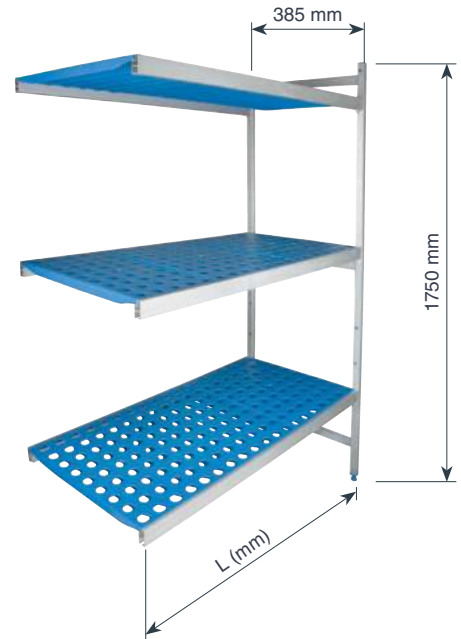
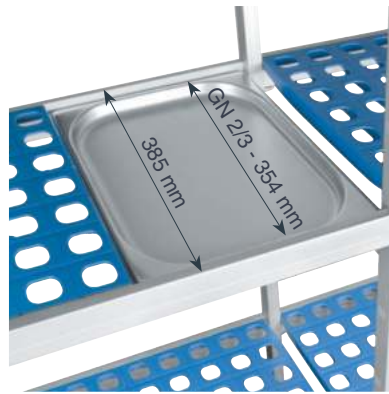

### Estantería abierta

Rayonnage ouvertes  
 Offenes Regale  
 Open shelving  
 Estantes abertas

#### 3 Estantes · Shelf

#### 4 Estantes · Shelf

#### 5 Estantes · Shelf

SIMPLE	L (mm)	Ref	€	Desglose · Breakdown	Ref	€	Desglose · Breakdown	Ref	€	Desglose · Breakdown
	682	55631	232,00	56317 x 1 + 56007 x 3	55640	279,70	56317 x 1 + 56007 x 4	55649	327,30	56317 x 1 + 56007 x 5
	794	55632	239,50	56317 x 1 + 56008 x 3	55641	290,00	56317 x 1 + 56008 x 4	55650	340,30	56317 x 1 + 56008 x 5
	904	55633	254,60	56317 x 1 + 56009 x 3	55642	309,60	56317 x 1 + 56009 x 4	55651	365,10	56317 x 1 + 56009 x 5
	1009	55634	277,10	56317 x 1 + 56010 x 3	55643	339,80	56317 x 1 + 56010 x 4	55652	402,70	56317 x 1 + 56010 x 5
	1119	55635	292,50	56317 x 1 + 56011 x 3	55644	360,10	56317 x 1 + 56011 x 4	55653	428,20	56317 x 1 + 56011 x 5
	1229	55636	305,30	56317 x 1 + 56012 x 3	55645	377,10	56317 x 1 + 56012 x 4	55654	449,40	56317 x 1 + 56012 x 5
	1339	55637	312,50	56317 x 1 + 56013 x 3	55646	387,00	56317 x 1 + 56013 x 4	55655	461,80	56317 x 1 + 56013 x 5
	1472	55638	342,60	56317 x 1 + 56014 x 3	55647	427,10	56317 x 1 + 56014 x 4	55656	511,80	56317 x 1 + 56014 x 5
	1554	55639	350,10	56317 x 1 + 56015 x 3	55648	437,20	56317 x 1 + 56015 x 4	55657	524,30	56317 x 1 + 56015 x 5

Fondo · Width: 385 mm  
 Altura · Height: 2.000 mm

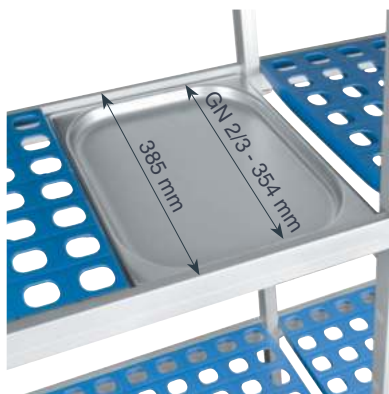

### Estantería abierta

Rayonnage ouvertes  
 Offenes Regale  
 Open shelving  
 Estantes abertas

#### 3 Estantes · Shelf

#### 4 Estantes · Shelf

#### 5 Estantes · Shelf

SIMPLE	L (mm)	Ref	€	Desglose · Breakdown	Ref	€	Desglose · Breakdown	Ref	€	Desglose · Breakdown
	682	55658	246,70	56320 x 1 + 56007 x 3	55667	294,30	56320 x 1 + 56007 x 4	55676	342,00	56320 x 1 + 56007 x 5
	794	55659	254,60	56320 x 1 + 56008 x 3	55668	305,10	56320 x 1 + 56008 x 4	55677	355,10	56320 x 1 + 56008 x 5
	904	55660	269,20	56320 x 1 + 56009 x 3	55669	324,60	56320 x 1 + 56009 x 4	55678	379,80	56320 x 1 + 56009 x 5
	1009	55661	292,10	56320 x 1 + 56010 x 3	55670	354,70	56320 x 1 + 56010 x 4	55679	417,50	56320 x 1 + 56010 x 5
	1119	55662	307,10	56320 x 1 + 56011 x 3	55671	374,90	56320 x 1 + 56011 x 4	55680	443,00	56320 x 1 + 56011 x 5
	1229	55663	320,00	56320 x 1 + 56012 x 3	55672	390,90	56320 x 1 + 56012 x 4	55681	464,30	56320 x 1 + 56012 x 5
	1339	55664	327,30	56320 x 1 + 56013 x 3	55673	401,90	56320 x 1 + 56013 x 4	55682	476,50	56320 x 1 + 56013 x 5
	1472	55665	356,70	56320 x 1 + 56014 x 3	55674	441,90	56320 x 1 + 56014 x 4	55683	526,50	56320 x 1 + 56014 x 5
	1554	55666	364,80	56320 x 1 + 56015 x 3	55675	451,90	56320 x 1 + 56015 x 4	55684	539,00	56320 x 1 + 56015 x 5

Fondo · Width: 560 mm  
 Altura · Height: 1.750mm

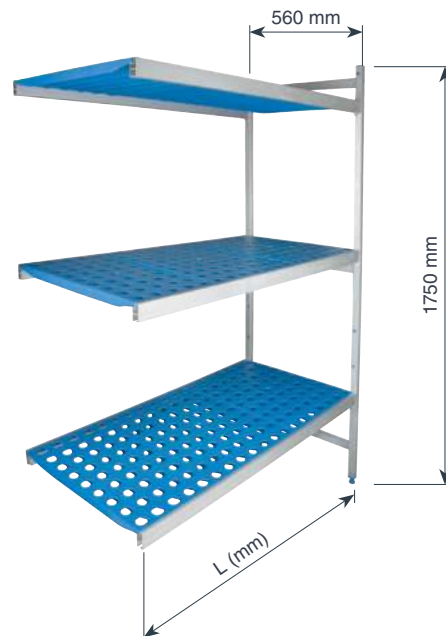
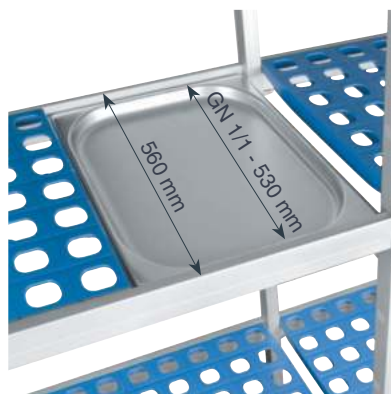

### Estantería abierta

Rayonnage ouvertes  
 Offenes Regale  
 Open shelving  
 Estantes abertas

#### 3 Estantes · Shelf

#### 4 Estantes · Shelf

#### 5 Estantes · Shelf

SIMPLE	3 Estantes · Shelf			4 Estantes · Shelf			5 Estantes · Shelf			
	L (mm)	Ref	€	Desglose · Breakdown	Ref	€	Desglose · Breakdown	Ref	€	Desglose · Breakdown
	682	55931	261,80	57317 x 1 + 57007 x 3	55940	317,40	57317 x 1 + 57007 x 4	55949	371,60	57317 x 1 + 57007 x 5
	794	55932	269,20	57317 x 1 + 57008 x 3	55941	327,10	57317 x 1 + 57008 x 4	55950	384,00	57317 x 1 + 57008 x 5
	904	55933	284,40	57317 x 1 + 57009 x 3	55942	347,20	57317 x 1 + 57009 x 4	55951	410,00	57317 x 1 + 57009 x 5
	1009	55934	320,00	57317 x 1 + 57010 x 3	55943	394,40	57317 x 1 + 57010 x 4	55952	469,10	57317 x 1 + 57010 x 5
	1119	55935	334,80	57317 x 1 + 57011 x 3	55944	414,90	57317 x 1 + 57011 x 4	55953	494,40	57317 x 1 + 57011 x 5
	1229	55936	350,10	57317 x 1 + 57012 x 3	55945	433,30	57317 x 1 + 57012 x 4	55954	519,30	57317 x 1 + 57012 x 5
	1339	55937	364,80	57317 x 1 + 57013 x 3	55946	454,20	57317 x 1 + 57013 x 4	55955	543,80	57317 x 1 + 57013 x 5
	1472	55938	393,40	57317 x 1 + 57014 x 3	55947	494,30	57317 x 1 + 57014 x 4	55956	593,90	57317 x 1 + 57014 x 5
	1554	55939	409,60	57317 x 1 + 57015 x 3	55948	514,10	57317 x 1 + 57015 x 4	55957	618,60	57317 x 1 + 57015 x 5

Fondo · Width: 560 mm  
 Altura · Height: 2.000 mm

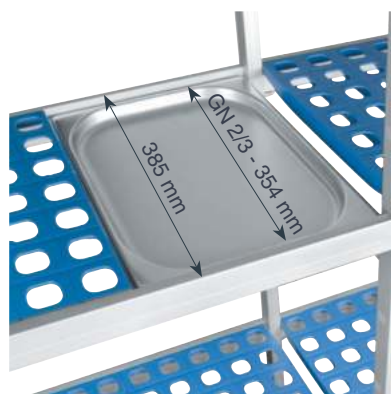

### Estantería abierta

Rayonnage ouvertes  
 Offenes Regale  
 Open shelving  
 Estantes abertas

#### 3 Estantes · Shelf

#### 4 Estantes · Shelf

#### 5 Estantes · Shelf

SIMPLE	3 Estantes · Shelf			4 Estantes · Shelf			5 Estantes · Shelf			
	L (mm)	Ref	€	Desglose · Breakdown	Ref	€	Desglose · Breakdown	Ref	€	Desglose · Breakdown
	682	55958	276,70	57320 x 1 + 57007 x 3	55967	332,10	57320 x 1 + 57007 x 4	55976	386,70	57320 x 1 + 57007 x 5
	794	55959	284,10	57320 x 1 + 57008 x 3	55968	341,70	57320 x 1 + 57008 x 4	55977	399,00	57320 x 1 + 57008 x 5
	904	55960	299,30	57320 x 1 + 57009 x 3	55969	361,90	57320 x 1 + 57009 x 4	55978	423,80	57320 x 1 + 57009 x 5
	1009	55961	334,50	57320 x 1 + 57010 x 3	55970	409,30	57320 x 1 + 57010 x 4	55979	484,00	57320 x 1 + 57010 x 5
	1119	55962	350,10	57320 x 1 + 57011 x 3	55971	429,60	57320 x 1 + 57011 x 4	55980	509,20	57320 x 1 + 57011 x 5
	1229	55963	364,80	57320 x 1 + 57012 x 3	55972	449,40	57320 x 1 + 57012 x 4	55981	533,80	57320 x 1 + 57012 x 5
	1339	55964	379,50	57320 x 1 + 57013 x 3	55973	469,10	57320 x 1 + 57013 x 4	55982	558,60	57320 x 1 + 57013 x 5
	1472	55965	409,60	57320 x 1 + 57014 x 3	55974	509,10	57320 x 1 + 57014 x 4	55983	608,50	57320 x 1 + 57014 x 5
	1554	55966	424,50	57320 x 1 + 57015 x 3	55975	528,80	57320 x 1 + 57015 x 4	55984	633,40	57320 x 1 + 57015 x 5



# Cestas

Racks

# Colección CESTAS

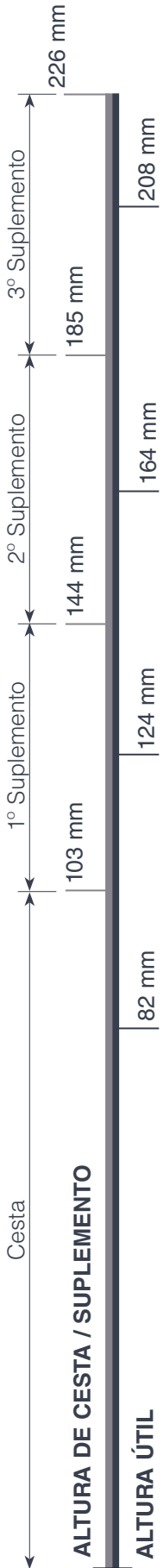

## Verificador de diámetros

Vérifiez le diamètre · Chek the diameter · Diameter prufungen · Medidor de diámetros

**49** Compart.  
Teillen

64x64 mm

**36** Compart.  
Teillen

75x75mm

**25** Compart.  
Teillen

90x90 mm

**16** Compart.  
Teillen

113x113 mm

**Sistema único de apilación, permite un fácil montaje**  
 Unique folding system enables racks to be constructed

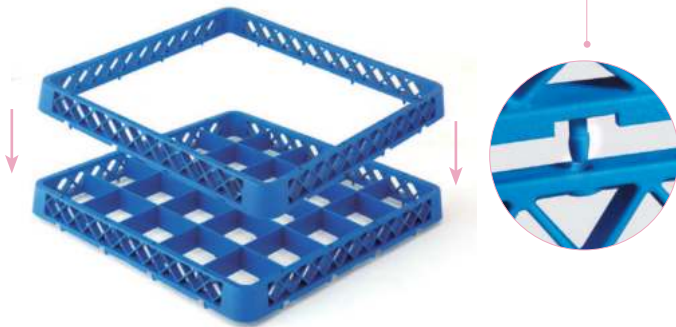

- La alta calidad de sus materiales hacen que la resistencia al calor y a los impactos sea óptima, por lo que su durabilidad está garantizada.
- Su sistema único de apilación permite un fácil montaje, y lo que es más novedoso, el desmontaje del mismo siempre que usted lo desee.
- Su estructura abierta permite una mayor rapidez en el lavado y secado debido a una mejor circulación de agua y del aire.
- El diseño de las asas hacen que su manejo y carga sean cómodos y sin riesgos. Además, para facilitar su manejo, está disponible un carro porta cestas útil para evitar esfuerzos en los desplazamientos.
- Adaptable a la mayoría de las cestas existentes en el mercado.

- The high quality of the materials used in this range give total protection against heat and shocks and thus guarantees durability.
- The unique folding system enables racks to be constructed and dismantled at will.
- The open structure enables a better circulation of both water and air for an easier wash and dry.
- The handle design makes loading and transport easy and risk-free. As an option a dolly is available to assist in the handling of racks.
- This product is compatible with the majority of other dishwasher baskets on the market.

### Cesta base

Casier universel  
 Spülkorb  
 Universal open rack  
 Cesta base



Ref	€	cm	U.Venta
69235	35,80	35x35x12	1
69240	36,70	40x40x11	1

### Cesta base universal

Casier universel  
 Universalspülkorb  
 Universal open rack  
 Cesta base universal



Ref	€	cm	U.Venta
69250	27,20	50x50x10,3	1

### Suplemento altura abierta

Réhausse sans compart.  
 Ergänzung  
 Universal open extender  
 Suplem. altura aberto



Ref	€	cm	U.Venta
69251	11,30	50x50x4,5	1

### Cesta base 16 compartimentos

Casier 16 compartments  
 Spülkorb 16-tlg.  
 Rack with 16 compartments  
 Cesta base 16 compart.



Ref	€	cm	U.Venta
69214	32,60	50x50x10,3	1

### Suplem. altura 16 compartimentos

Réhausse, 16 comp.  
 Ergänzung 16-tlg. Spülkorb  
 Extender for rack with 16 compart.  
 Suplem. altura 16 compart.



Ref	€	cm	U.Venta
69217	13,90	50x50x4,5	1

### Cesta base 25 compartimentos

Casier 25 compartments  
 Spülkorb 25-tlg.  
 Rack with 25 compartments  
 Cesta base 25 compart.



Ref	€	cm	U.Venta
69225	34,30	50x50x10,3	1

### Suplem. altura 25 compartimentos

Réhausse, 25 comp.  
 Ergänzung 25-tlg. Spülkorb  
 Extender for rack with 25 compart.  
 Suplem. altura 25 compart.



Ref	€	cm	U.Venta
69226	14,80	50x50x4,5	1





### Cesta base 36 compartimentos

Casier 36 compartiments  
Spülkorb 36-tlg.  
Rack with 36 compartments  
Cesta base 36 compart.

Ref	€	cm	U.Venta
69236	36,10	50x50x10,3	1



### Suplem. altura 36 compartimentos

Réhausse, 36 comp.  
Ergänzung 36-tlg. Spülkorb  
Extender for rack with 36 compart.  
Suplem. altura 36 compart.

Ref	€	cm	U.Venta
69237	14,80	50x50x4,5	1



### Cesta base 49 compartimentos

Casier 49 compartiments  
Spülkorb 49-tlg.  
Rack with 49 compartments  
Cesta base 49 compart.

Ref	€	cm	U.Venta
69249	37,10	50x50x10,3	1



### Suplem. altura 49 compartimentos

Réhausse, 49 comp.  
Ergänzung 49-tlg. Spülkorb  
Extender for rack with 49 compart.  
Suplem. altura 49 compart.

Ref	€	cm	U.Venta
69248	15,80	50x50x4,5	1



### Cesta para platos

Casier pour assiettes  
Tellerspülkorb  
Small trays and dishes rack  
Cesta para pratos

Ref	€	cm	U.Venta
69202	27,30	50x50x10,3	1



### Cesta para platos

Casier pour assiettes  
Tellerspülkorb  
Small trays and dishes rack  
Cesta para pratos

Ref	€	cm	U.Venta
69234	36,40	35x35x12	1
69241	42,80	40x40x11	1



### Cesta para platos/bandejas

Casier pour grands platex  
Plattenspülkorb  
Universal open side trays rack  
Cesta pratos/bandejas

Ref	€	cm	U.Venta
69203	33,80	50x50x10,3	1



### Soporte para platos

Support pour les plats  
Tellerhalter  
Plate holder  
Suporte para pratos

Ref	€	cm	U.Venta
69207	10,60	31,0x9,5x7(15)	1
69213	12,20	34,5x9,5x7(17)	1



### Cesta para cubiertos

Casier à couverts  
Besteckspülkorb  
Flatware/utensil rack  
Cesta para talheres

Ref	€	cm	U.Venta
69204	26,90	50x50x10,3	1



### Tapa cesta universal

Couvercle pour casier universel  
Deckel für Universals Spülkorb  
Standard rack's lid  
Tampa cesta universal

Ref	€	cm	U.Venta
69205	21,40	50x50x2,5	1

### Cesta 8 compart. cubiertos

Panier à couverts, 8 compart.  
Besteckspülkorb 8 tlg.  
Cutlery rack with 8 compart.  
Cesta 8 compart. talheres



Ref	€	cm	U.Venta
69208	17,00	20,5x43x13	1

### Cubilete cubiertos

Petit panier à couverts  
Besteckbehälter  
Cutlery cube  
Cesta talheres



Ref	€	cm	U.Venta
69215	5,20	12,5x12,5x13,5	6



### Carro porta-cestas

Socle à roulettes pour casier  
Transportwagen fuer Spuelkoerbe  
Trolley for racks  
Carro porta-cestas



Ref	€	cm	U.Venta	
69211	213,00	55x57x80	1	Con asa · With handle
69212	129,80	55x57x20	1	Sin asa · Without handle

# Limpieza

Cleaning



# DISPENSADORES de jabón/gel

## ABS

Plastic



- Dispensador manual de jabón y gel.
- Perfecto para almacenar y dispensar geles desinfectantes, jabones, champús u otros materiales líquidos.
- Tamaño compacto; ideal para oficinas, hogares, restaurantes, etc.
- Ventana transparente que permite controlar la cantidad de líquido disponible.
- Diseñado para colocar en la pared y ahorrar espacio.
- Depósito extraíble para rellenar fácilmente.

- Distributeur manuel de savon et gel.
- Parfait pour accueillir et distribuer du gel, du désinfectant, du savon, du shampooing, ou tout autre élément liquide.
- Taille compacte ; idéale pour les bureaux, la maison, les restaurants, etc.
- Fenêtre transparente qui permet de contrôler la quantité de liquide disponible.
- Conçu pour être installé sur un mur et ainsi gagner de l'espace.
- Réservoir extractible pour un remplissage facile.

- Handspender für Seife und Gel.
- Ideal zum Vorhalten und Ausgeben von Desinfektionsgel, Seife, Shampoo oder anderen Flüssigkeiten.
- Kompaktes Design, ideal für Büro, Haushalt, Restaurant usw.
- Füllstand durch Sichtfenster erkennbar.
- Platzsparende Wandmontage.
- Herausnehmbarer Behälter ist leicht nachfüllbar.

- Manual soap and gel dispenser.
- Perfect for storing and dispensing disinfectant gel, soap, shampoo or other liquids.
- Compact size; ideal for home, office, restaurants, etc.
- It has a transparent window so you can see how much liquid is available.
- It is designed for installing on the wall and to save space.
- Removable container for easy refilling.

- Dispensador manual de sabão líquido e gel.
- Ideal para armazenar e dispensar geles desinfetantes, sabões, champôs e outros produtos líquidos.
- Tamanho compacto; ideal para oficinas, lares, restaurantes, etc.
- Visor transparente que permite controlar a quantidade de líquido disponível.
- Concebido para colocar na parede e poupar espaço.
- Depósito extraível e fácil de encher.



**Fácil de rellenar**  
Easy to fill



## PE

Polyethylene  
Gel container

### Dispensadores de jabón/gel

Distributeur de savon et gel  
Seifen- und Gelspender  
Soap and gel dispenser  
Dispensador de sabão e gel

	Ref	€	ml	Color	U.Venta
A	91520	11,90	0,350	Cromado · Chrome	1
B	91521	10,80	0,350	Negro · Black	1

## SAN

plastic  
Gel container



### Dispensadores de jabón/gel WHITE

Distributeur de savon et gel  
Seifen- und Gelspender  
Soap and gel dispenser  
Dispensador de sabão e gel

	Ref	€	L	U.Venta
	91525	24,00	1,10	1

# DISPENSADORES automáticos y soporte

ABS	PE	FE
Plastic	Polyethylene	Iron
Dispensador Dispenser		Soporte Support



- Permite ubicar el dispensador de gel en cualquier lugar, sin necesidad de depender de ninguna pared o superficie vertical (Ref. 91540).
- Apto para gel hidroalcohólico y jabón líquido.
- Funcionamiento con sensor, detección entre 5-9 cm de altura.
- Opción de ajustar el caudal entre 0,5 y 2,5 ml.
- Ideal para zonas de gran movimiento de gente.
- Posibilidad de comprar el soporte solo o con el dosificador de gel.

- Permet d'installer le distributeur de gel n'importe où, sans avoir besoin d'un mur ou d'une surface verticale (Ref. 91540).
- Apte pour du gel hydroalcoolique et du savon liquide.
- Fonctionnement avec capteur, détection de 5 à 9 cm de hauteur.
- Option de réglage du débit de 0,5 à 2,5 ml.
- Idéal pour des zones de grand passage.
- Possibilité d'acheter le support seul ou avec le flacon doseur de gel.

- Der Ständer ermöglicht, Gelspender an beliebigen Orten aufzustellen, auch ohne Wände oder vertikale Flächen (Ref. 91540).
- Für keimtötendes Gel mit Alkohol und Flüssigseife.
- Sensorsteuerung funktioniert ab 5-9 cm Handdistanz.
- Ausgabemenge zwischen 0,5 ml und 2,5 ml einstellbar.
- Ideal für stark frequentierte Bereiche.
- Ständer ist separat oder mit Gelspender erhältlich.

- Lets you put a gel dispenser anywhere without needing to rely on any walls or vertical surfaces (Ref. 91540).
- Can be used with hydroalcoholic gel or liquid soap.
- Works using a sensor that can detect at a height of 5 cm to 9 cm.
- The flow can be adjusted from 0.5 ml to 2.5 ml.
- Perfect for areas with a lot of human traffic.
- The support is sold separately or with the gel dispenser.

- Permite situar o dispensador de gel hidroalcoólico em qualquer lugar, sem necessidade de dispor de uma parede ou superfície vertical (Ref. 91540).
- Apto para gel hidroalcoólico e sabonete líquido.
- Funcionamento por sensor, com detecção entre 5 - 9 cm de altura.
- Caudal regulável entre 0,5 e 2,5 ml.
- Ideal para zonas de grande movimento de pessoas.
- Possibilidade de comprar só o suporte ou incluir o dispensador de gel.



**Posibilidad de colocar en pared**  
Possibility of wall mounting



**Fácil de rellenar**  
Easy to fill

A



B



**Cierre con llave**  
Lockable with a key

**Funcionan con 4 pilas AA (No incluidas)**  
Uses 4 AA batteries (not included)

A



B



C



**Altura regulable**  
Max: 150 cm / Min: 105 cm  
Adjustable height  
Max: 150 cm / Min: 105 cm

## Dispensadores automáticos de jabón/gel

Distributeur automatique de savon et gel  
Automatischer Seifen-und Gelspender  
Automatic soap and gel dispenser  
Dispensador automático de sabão e gel

	Ref	€	ml	cm	U.Venta
A	91522	80,00	850	11x12x26	1 SILVER
B	91523	80,00	850	11x12x26	1 WHITE

## Soporte dispensador de gel

Support distributeur de gel  
Gelspenderhalter  
Gel dispenser holder  
Suporte dispensador de gel

	Ref	€	h (cm)	U.Venta
A	91540	71,10	160	1 Soporte · Support
B	91541	149,20	160	1 Sop. + SILVER · Support + SILVER
C	91542	149,20	160	1 Sop. + WHITE · Support + WHITE

# SECADOR de manos

Inox  
18/10

- Para montaje en pared (recomendable a unos 110 cm del suelo).
- Ideal para instalar en baños como en cocinas o vestuarios.
- Compacto, robusto y especialmente higiénico.
- Tiempo de secado ajustable.
- Sistema de apagado automático (tiempo máximo 30 seg).
- Protección del medio ambiente evitando toallas de papel.

- Pour montage sur mur (recommandé à environ 110 cm du sol).
- Idéal pour installer aussi bien dans des salles de bain que dans des cuisines ou des vestiaires.
- Compact, robuste et particulièrement hygiénique.
- Durée de séchage réglable.
- Système d'arrêt automatique (durée maximum : 30 s).
- Protection de l'environnement en évitant l'utilisation de serviettes en papier.

- Zur Wandmontage (empfohlen ca. 110 cm über dem Boden).
- Ideal für die Installation in Badezimmern wie Küchen oder Umkleidekabinen.
- Kompakt, robust und besonders hygienisch.
- Einstellbare Trocknungszeit.
- Automatisches Abschaltssystem (maximale Zeit 30 Sekunden).
- Schutz der Umwelt durch Vermeidung von Papiertüchern.

- Designed for wall mounting (recommended height around 110 cm from the floor).
- Perfect for installing in bathrooms, kitchens or dressing rooms.
- Compact, robust and extremely hygienic.
- Adjustable drying time.
- Automatic shut-off system (maximum time 30 sec).
- Protects the environment by not using paper towels.

- Para montagem na parede (recomendado a cerca de 110 cm do solo).
- Ideal para instalar em casas de banho como cozinhas ou vestiários.
- Compacto, robusto e particularmente higiénico.
- Tempo de secagem ajustável.
- Sistema de desligamento automático (tempo máximo de 30 segundos).
- Proteger o meio ambiente evitando toalhas de papel.



## Secador de manos con pulsador

Sèche-mains à bouton  
Händetrockner mit Knopf  
Hand dryer with pusher  
Secador de mão com botão

Ref	€	W	cm	U.Venta
69501	340,90	2300	26x15x23	1

Ref	Tensión/Voltage	Potencia/Power	Veloc. aire/Air speed	Dist. acción/Action dist.	Dimensiones/Sizes	Peso/Weight
69501	220-240 V; 50 Hz	2300 W	19 m/s	50 - 200 mm	26x15x23 cm	4,50 Kg

# ESCURRIDOR de cocina



Orificio para colgar  
Hanging hole

- Escurreplatos de silicona antideslizante para colocar en la encimera y dejar secar los platos recién fregados.
- Su diseño con relieves proporciona una buena ventilación para un secado rápido de la vajilla, cacerolas, utensilios, platos, copas, etc.
- El agua queda retenida entre los surcos para su posterior vaciado en el fregadero.
- Fácil de enrollar para guardarla en cualquier cajón o armario de la cocina.

- Tapis égouttoir en silicone antidérapant à installer sur le plan de travail pour laisser sécher la vaisselle qui vient d'être lavée.
- Sa conception avec des reliefs apporte une bonne ventilation pour un séchage rapide de la vaisselle, des casseroles, des ustensiles, des assiettes, des verres, etc.
- L'eau est retenue entre les creux pour ensuite être évacuée dans l'évier.
- Facile à enrouler pour le ranger dans n'importe quel tiroir ou meuble de cuisine.

- Non-slip silicone dish mat to put on the countertop and let recently washed dishes dry.
- Its ridged design provides good ventilation for drying dishes, casseroles, utensils, plates or glasses quickly.
- The water gets captured between the grooves so it can be emptied into the wash basin.
- It's easy to roll up and store in any drawer or cabinet in the kitchen.

## Escurreplatos de silicona

Tapis égouttoir en silicone  
Abtropfmatte aus Silikon  
Silicone dish mat  
Escorredor para pratos de silicona

Silicona flexible y duradera  
Flexible and durable silicone



Ref	€	cm	U.Venta
66774	17,70	42,5x32	1

# Colección papeleras con pedal **INOX & NATURE**

Inox **PP**  
Polypropylene  
Container



- Fabricadas en acero inoxidable de gran calidad
- Tapa 100% de bambú natural (63335/63355).
- Ideal para baños de hoteles, restaurantes y todo tipo de establecimientos.
- Prácticas, compactas y funcionales.
- Superficie en acabado gris / blanco / negro mate.
- Apertura de tapa mediante pedal.
- Sistema de cierre **SoftClosing**; la tapa se cierra suave y silenciosamente.
- Cubeta interior extraíble de polipropileno con asa.
- Pies antideslizantes.

- Fabriqué en acier inoxydable de haute qualité
- Couvercle en bambou 100 % naturel (63335/63355).
- Idéale pour les salles de bain des hôtels, des restaurants et de tout type d'établissement.
- Compactes et fonctionnelles.
- Surface in gray / white / matt black finish.
- Ouverture du couvercle par pédale.
- Système de fermeture **SoftClosing** : le couvercle se referme doucement et silencieusement.
- Cuve intérieure extractible en polypropylène avec anse.
- Pieds antidérapants.

- Hergestellt aus hochwertigem Edelstahl.
- Deckel aus 100 % natürlichem Bambus (63335/63355).
- Ideal für Toiletten in Hotels, Restaurants und sonstigen Einrichtungen.
- Praktisch, kompakt und funktionell.
- Ausführung in grau / weiß / schwarz matt.
- Pedalöffnung.
- Deckelverschluss **SoftClosing**: deckel gedämpft und leise.
- Herausnehmbarer Inneneimer aus Polypropylen mit Griff.
- Antirutschfüße.

- Made of high quality stainless steel.
- 100% natural bamboo lid (63335/63355).
- Perfect for hotel bathrooms, restaurants and all kinds of businesses.
- Practical, compact and functional.
- Surface in grey / white / black matt finish.
- The lid opens using a pedal.
- **SoftClosing** system: the lid closes smoothly and silently.
- It has a removable polypropylene inner liner with a handle.
- Non-slip feet.

- Fabricadas em aço inoxidável de alta qualidade.
- Tapa de bambu 100% natural (63335/63355).
- Ideal para quartos de banho de hotéis, restaurantes e todo o tipo de estabelecimentos.
- Prácticas, compactas e funcionales.
- Superfície com acabamento cinza / branco / preto fosco.
- Pedal de abertura da tampa.
- Sistema **SoftClosing**: a tampa fecha-se de maneira suave e silenciosa.
- Cuvete interior extraível de polipropileno, com asa.
- Patas antideslizantes.

**Inox 18/10**  
Tapa desmontable  
Removable lid



**Tapa de práctico giro**  
Practical swing lid

## Papelerera sobremesa

Poubelle de table  
Tish-Abfallbehälter  
Table bin  
Papeleira de mesa

Ref	€	Ø (cm)	h (cm)	L	U.Venta
63302	24,10	12	16	1,20	1



**Sistema de cierre SoftClosing**  
Closing system  
**SoftClosing**

## Papelerera con pedal INOX

Poubelle à pédale  
Tret-Abfallbehälter  
Pedal bin  
Papeleira com pedal

Ref	€	Ø (cm)	h (cm)	L	U.Venta
63303	22,10	17,0	25,5	3,0	1
63305	28,90	20,5	28,0	5,0	1
63312	42,70	25,0	40,0	12,0	1
63319	61,20	29,0	45,0	20,0	1



**Cubeta interior extraíble de polipropileno con asa**  
It has a removable polypropylene inner liner with a handle



**Sistema de cierre  
SoftClosing**  
Closing system  
SoftClosing



**Cubeta interior extraíble  
de polipropileno con asa**  
It has a removable  
polypropylene inner liner  
with a handle



### Papelera con pedal

Poubelle à pédale  
Tret-Abfallbehälter  
Pedal bin  
Papeleira com pedal

Ref	€	Ø (cm)	h (cm)	L	Color	U.Venta
63306	23,30	16,8	25	3,0	GREY	1
63307	23,30	16,8	25	3,0	WHITE	1
63309	23,30	16,8	25	3,0	BLACK	1



**Sistema de cierre  
SoftClosing**  
Closing system  
SoftClosing

**Bambú**



**Cubeta interior extraíble  
de polipropileno con asa**  
It has a removable  
polypropylene inner liner  
with a handle



*new*

**Fe** **Bambú**  
Iron Bamboo  
Tapa/Lid

### Papelera con pedal NATURE

Poubelle à pédale  
Tret-Abfallbehälter  
Pedal bin  
Papeleira com pedal

Ref	€	Ø (cm)	h (cm)	L	Color	U.Venta
63335	54,80	20,5	27,6	5,0	BLACK	1
63355	54,80	20,5	27,6	5,0	WHITE	1

## Cepillos **RECOGEMIGAS**

**Botón apertura de tapa**  
Lid opening button



**Inox  
18/10**



**Sistema rotativo de giro  
rápido y simultáneo**  
Rotating system of rapid and  
simultaneous rotation



**Sistema rotativo de giro  
rápido y simultáneo**  
Rotating system of rapid and  
simultaneous rotation



### Cepillo recogemigas

Ramasse-miettes à rouleaux  
Krümelbürste  
Crumbs cleaner  
Escova apanha-migalhas

Ref	€	cm	h (cm)	U.Venta
64407	14,70	9,5x16,5	4,0	1

### Cepillo recogedor **HIPERLUXE**

Ramasse-miettes à rouleaux **HIPERLUXE**  
Krümelbürste, **HIPERLUXE**  
**HIPERLUXE** crumbs cleaner  
Escova apanha-migalhas **HIPERLUXE**

Ref	€	cm	U.Venta
64408	49,70	14,5x17	1

### Cepillo recogedor **LUXE**

Ramasse-miettes **LUXE**  
Krümelbürste, **LUXE**  
**LUXE** crumbs cleaner  
Espátula apanha-migalhas **LUXE**

Ref	€	cm	U.Venta
64409	30,90	22x7	1



# Dispensador de **FILM · PAPEL ALUMINIO**



**Compatible para bobinas de film o aluminio de hasta 45 cm de ancho**  
Compatible for film or aluminum reels up to 45 cm wide

**Ajustable hasta 45 cm de ancho**  
Adjustable up to 45 cm wide

**Posibilidad de anclarlo en la pared**  
Possibility to anchor it on the wall



**Doble cuchilla; cuchilla deslizante y cuchilla dentada**  
Double blade; sliding blade and serrated blade

- Práctico e higiénico, ideal para tiendas, bares, restaurantes, panaderías, carnicerías, pescaderías, etc.
- Doble cuchilla: cuchilla deslizante para el corte del film transparente y aluminio.
- Cuchilla dentada para el corte del film de aluminio (incluida en el interior de la tapa).
- Ambas cuchillas proporcionan un corte limpio y preciso con máxima seguridad.
- Cuenta con 4 tacos antideslizantes para evitar su desplazamiento a la hora de extraer el film o papel de aluminio.
- Diseño para utilizarlo en la encimera o anclado en la pared (incluye tacos y tornillos).

- Pratique et hygiénique, idéal pour les magasins, les bars, les restaurants, les boulangeries, les boucheries, les poissonneries, etc.
- Double lame: lame coulissante pour couper le film transparent et l'aluminium.
- Lame dentelée pour couper le film d'aluminium (inclus à l'intérieur du couvercle).
- Les deux lames confèrent une découpe propre et précise avec une sécurité maximale.
- Dispose de 4 pieds antidérapants pour éviter son déplacement lors de l'extraction du film alimentaire ou du papier aluminium.
- Conçu pour être installé sur le plan de travail ou fixé au mur (inclut des vis et des chevilles).

- Praktisch und sauber, ideal für Läden, Bars, Restaurants, Bäckereien, Metzgereien, Fischverkäufer usw.
- Doppelklinge: Gleitschneider zum Schneiden von transparenter Folie und Aluminium.
- Gezackte Klinge zum Schneiden von Aluminiumfolie (im Deckel enthalten).
- Beide Klingen macht einen sauberen und genauen Schnitt mit maximaler Sicherheit.
- Verfügt über 4 Antirutschdübel, damit der Halter bei Entnahme der Frischhalte- oder Aluminiumfolie nicht verrutscht.
- Konzipiert zum Gebrauch auf der Arbeitsfläche oder an der Wand (Dübel und Schrauben im Lieferumfang enthalten).

- It's practical and hygienic and perfect for shops, bars, restaurants, bakeries, butcher shops, fish mongers, etc.
- Double blade: sliding blade for cutting transparent film and aluminum.
- Serrated blade for cutting aluminum film (included inside the lid).
- Both blades provide a makes a clean and precise cut with maximum safety.
- It has four non-slip pads to keep it from sliding when film or aluminium foil is pulled out
- It's designed to be used on a counter or anchored to a wall (screws and rawlplugs included).

- Práctico e higiénico, ideal para establecimientos comerciais, bares, restaurantes, padarias, talhos, peixarias, etc.
- Lâmina dupla: lâmina deslizante para cortar o filme transparente e o alumínio.
- Lâmina serrilhada para cortar filme de alumínio (incluída dentro da tampa).
- Ambas as lâminas proporcionan um corte limpo e preciso, com a máxima segurança
- 4 patas antidescizantes, que evitam qualquer movimento ao extrair o filme, ou o papel de alumínio.
- Concebido para ser utilizado em cima da bancada, ou fixo à parede (inclui tacos e parafusos).

## Bobina aluminio

Rouleau aluminium  
Aluminiumfolie  
Aluminium foil  
Bobina alumínio



Ref	€	Film (m)	Caja (cm)	Micras (µm)	U.Venta
10330	55,20	0,30x300	10x35	11	1
10430	67,80	0,40x300	10x42	11	1

## Bobina film transparente

Rouleau film transparent  
Frischhaltefolie  
Transparent cling film  
Bobina filme transparente



Ref	€	Film (m)	Caja (cm)	Micras (µm)	U.Venta
11330	14,10	0,30x300	10x33	10	1
11430	21,80	0,45x300	10x48	10	1

## Dispensador de film o papel aluminio

Distributeur de film ou de papier d'aluminium  
Folien- oder Alu-Folienspender  
Film or aluminium foil dispenser  
Dispensador de filme ou folha de alumínio

Ref	€	cm	U.Venta
60704	73,30	56,5x20x16,5	1

# Colección PORTARROLLOS DE COCINA

Inox  
18/10

new

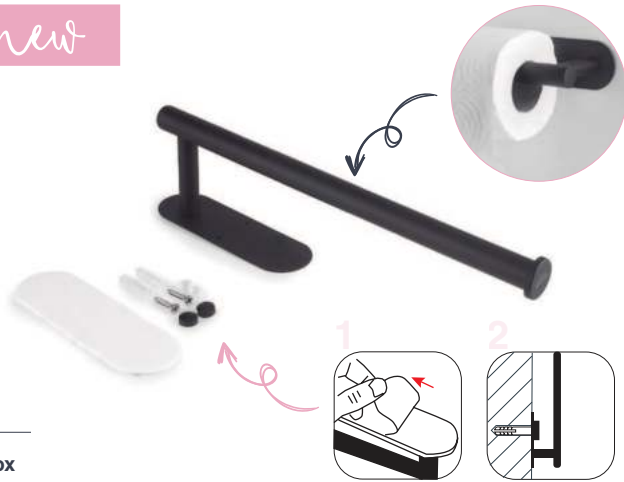

2 opciones para instalar  
2 options to install

- Fabricado en acero inoxidable de alta calidad, acabado negro mate.
- Duradero y resistente, a prueba de óxido.
- Diseño moderno y elegante. Capacidad: 1 rollo de cocina (longitud de rollos: 30 cm y 6 cm de grosor).
- Perfecto para colocar el papel de cocina y mantener la encimera despejada.
- Fácil de instalar. Opción de colocar mediante papel adhesivo o perforado con tornillos (ambos incluidos).
- Se puede instalar vertical u horizontalmente según las necesidades.

- Fabriqué en acier inoxydable de haute qualité, finition noire mate.
- Durable et résistant, antirouille.
- Design moderne et élégant. Capacité : 1 rouleau de papier de cuisine (longueur maximale de 30 cm et épaisseur de 6 cm).
- Parfait pour placer le rouleau de papier cuisine et garder le plan de travail dégagé.
- Facile à installer. Installation possible avec du papier adhésif ou perforé avec des vis (les deux inclus).
- Peut être installé verticalement ou horizontalement selon les besoins.

- Made of high quality stainless steel in a matt black finish.
- Long-lasting, sturdy and rust-proof.
- Modern, stylish design. Capacity: 1 kitchen roll (maximum length 30 cm, 6 cm thick).
- Perfect for paper kitchen rolls and keeping the worktop clear.
- Easy to install. Adhesive paper or screw hole mounting options (both included).
- Can be mounted vertically or horizontally as required.

Inox

## Portarrollos de cocina BLACK

Derouleur de cuisine  
Küchenrollenspender  
Dispenser for kitchen  
Porta-rolos cozinha

Ref	€	cm	h (cm)	U.Venta
62289	14,50	33,5x4,5	8	1

## Portarrollos de cocina de pared

Derouleur de cuisine  
Küchenrollenspender  
Multiroll dispenser for kitchen  
Porta-rolos cozinha de parede



	Ref	€	U.Venta
A	60701	58,80	6
B	60702	55,40	8

Rollos aptos para los portarrollos · Rolls suitable for multiroll dispenser

Ref.	Film transparente · Transparent film	Rollo aluminio · Aluminium foil	Rollo papel · Paper roll
60701	Ø50x320 mm	Ø50x320 mm	Ø180x330 mm
60702	Ø48x340 mm	Ø60x340 mm	Ø170x330 mm

Base contrapeso  
Counterbalance base

1 Kg



## Pie portarrollos

Dérouleur verticale pour papier essuie-tout  
Spänder für Küchenrolle  
Kitchen roll dispenser stand  
Pé porta-rolos



Ref	€	Ø (cm)	h (m)	U.Venta
50301	19,90	15	32,5	6

Inox

## Servilletero bar

Distributeur de serviettes bar  
Serviettenspender  
Bar napkin holder  
Guardanapo bar



	Ref	€	cm	Servilleta	U.Venta
A	61001	13,20	8,5x12	90x125	1
B	61002	9,40	9,5x13,5	9,5x13,5	4



**AL FU**

Aluminium Fundido/Cast

### Rasqueta profesional para grill

Raclair professionnel pour grill  
 Professioneller grillschaber  
 Professional grill scraper  
 Raspador profesional para grill

- Fabricada en una sola pieza de aluminio fundido.
- Cuchillas de acero inoxidable intercambiables.
- Se utiliza para raspar los residuos de los alimentos y el carbón de las planchas.
- Ergonómico gracias a los dos puntos de sujeción.
- Protección contra salpicaduras de residuos durante la limpieza.

- Fabriquée en une seule pièce en fonte d'aluminium.
- Lames en acier inoxydable interchangeable.
- Utilisée pour racler les résidus des aliments et le charbon des planchas.
- Ergonomique grâce aux deux points de prise en main.
- Protection contre les éclaboussures de résidus pendant le nettoyage.

- Made of a single piece of cast aluminium.
- Interchangeable stainless steel blades.
- Used to scrape food and charcoal residue from grills.
- Ergonomic design with two hand-holds.
- Splash guard to prevent residue from splashing upward during cleaning.

Ref	€	cm	L Cuchilla (cm)	U.Venta
67034	70,70	42x15x12	15	1

## CENICEROS exteriores

**Inox**  
18/10

### Cajón extraíble de acero galvanizado

Removable galvanized steel inner box



- Ceniceros para pared exterior. Cerradura con llave.
- Incluye material para fijación y una llave triangular.
- Cajetín interior de acero galvanizado extraíble para facilitar su limpieza.

- Cendrieres pour mur extérieur. Fermeture à clé.
- Comprend le matériel de fixation et une clé triangulaire.
- Boîtier intérieur en acier galvanisé extractible pour faciliter son nettoyage.

- Aschenbecher für Außenwände. Mit Schlüssel verschließbar.
- Material zur Befestigung an der Wand und Dreikantschlüssel im Lieferumfang enthalten.
- Innenfach aus verzinktem Stahl herausnehmbar, um die Reinigung zu erleichtern.

- Outdoor wall ashtray. Lock with key.
- Includes attachment elements and triangular key.
- Removable galvanized steel inner box for easy cleaning.

- Cinzeiros de parede para exteriores. Fechadura com chave.
- Inclui material para a sua fixação e uma chave triangular.
- Compartimento interior em aço galvanizado, extraível para facilitar a sua limpeza.

### Cenicero pared INOX

Mural cendrier  
 Wand aschenbecher  
 Wall ash try  
 Cinzeiro de parede

Ref	€	cm	h (cm)	U.Venta
63341	87,00	24,5x35	14	1

### Cajón extraíble de acero galvanizado

Removable galvanized steel inner box

### Acero galvanizado

Galvanized steel



**Colocación en pared**  
Wall mounting

**Posición de pie**  
Standing position



### Cenicero redondo

Cendrier extérieur rond  
 Aschenbecher round  
 Round ash try  
 Cinzeiro redondo

Ref	€	Ø (cm)	L	U.Venta	
63331	91,00	8x46	1,70	1	
A R63331A	3,90	-	-	1	Llave · Key
63332	145,50	8x92	1,50	1	
B R63332A	3,90	-	-	1	Llave · Key

### Cenicero pared BLACK

Mural cendrier  
 Wand aschenbecher  
 Wall ash try  
 Cinzeiro de parede

Ref	€	cm	h (cm)	U.Venta
63342	81,50	25x35	8,5	1

# Postes separadores **BLACK**

**FE**  
Inox  
Hierro/Iron

**Ideal para gestionar colas o separación de espacios**  
Perfect for queue management or space separation

- Ideal para la gestión de colas o separación de espacios.
- Estructura fabricada en hierro con recubrimiento de color negro.
- Cinta extensible retráctil de 2 m de longitud.
- Fácil de fijar y soltar las conexiones.

- Idéal pour la gestion de files d'attente ou la séparation d'espaces.
- Structure fabriquée en métal, recouverte de couleur noire.
- Sangle extensible rétractable de 2 m de longueur.
- Facilité de fixation et de détachement des connexions.

- Ideal für die Verwaltung von Warteschlangen oder zur Trennung von Räumen.
- Struktur aus schwarz beschichtetem Eisen.
- 2 m langes einziehbares Stretchband.
- Einfaches Anbringen und Lösen von Verbindungen.

- Perfect for managing queues or separating spaces.
- Iron structure with black coating.
- 2 m long extendible retractable belt .
- The connections are easy to attach and release.

- Ideal para a delimitação de filas e separação de espaços.
- Estructura fabricada em ferro com revestimento de cor preta.
- Fita extensível retrátil de 2 m de comprimento.
- Conexões fáceis de fixar e de soltar.



**Dispone de 2 conexiones**  
Permite conectar cintas para crear áreas separadas  
2 connections for connecting belts from other posts

**Dispone de 3 conexiones**  
Permite conectar cintas para crear áreas separadas  
3 connections for connecting belts from other posts

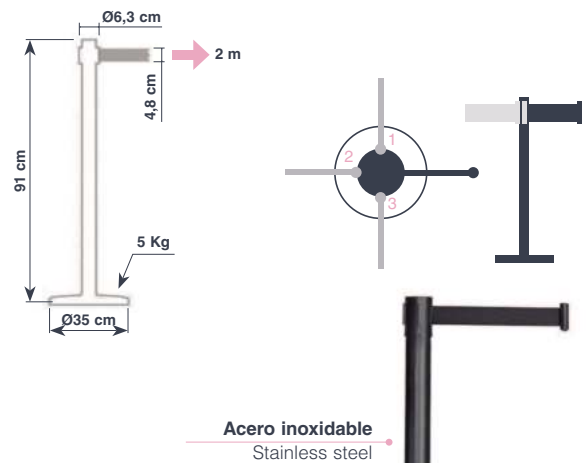
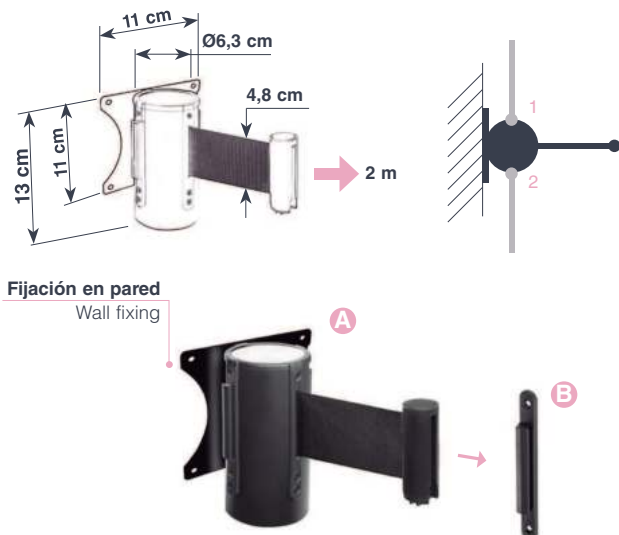

**Acero inoxidable**  
Stainless steel

## Separador pared **BLACK**

Séparateur mural  
Wandtrennpfosten  
Wall separator  
Separador de parede

	Ref	€	metros	U.Venta	
<b>A</b>	91530	36,60	2	1	(Incluye R91533A · Included)
<b>B</b>	R91533A	1,70	-	1	(Apta para la ref. 91533 · Suitable for ref.91533)

## Poste separador **BLACK**

Poteau séparateur  
Trennpfosten  
Separator post  
Poste separador

	Ref	€	metros	U.Venta
	91533	56,90	2	1



# Repostería

Pastry





**Preparación**  
Pastry processing

**Moldes · Aros**  
Moulds · Cake rings

# Jarras MEDIDAS

Inox  
18/10



Dishwasher



**Vertedor antigoteo**  
Non-drip spout

**Marcajes de capacidad**  
Capacity markings

## Jarra 5 litros

Pot en inox 5 L  
Kanne 5 L  
5 L. pitcher  
Jarra 5 L

Ref.	€	Ø (cm)	L	U.Venta
62750	75,80	17x22,5	5,00	1

## Jarra de medidas cónica

Pot mesureur  
Messbecher  
Measuring cup  
Jarra de medidas cónica



Ref	€	L	U.Venta
67010	36,00	1,00	1

**Marcajes de capacidad en el interior en onzas, ml, L y ccm (centímetro cúbico)**  
Capacity markings inside in ounces, mL, L and ccm (cubic centimetres)

**Jarra medidora**  
Pot  
mesureur  
Mass  
Behälter  
Measuring jug  
Jarra de medidas

	Ref	€	Ø (cm)	h (cm)	L	U.Venta
<b>A</b>	62745	14,40	9,0	10,5	0,5	1
<b>B</b>	62741	21,80	11,5	13,0	1,0	1
<b>C</b>	62742	25,80	15,0	17,0	2,0	1



**Vertedor antigoteo**  
Non-drip spout

**Sist. de lectura rápida en mililitros y cups**  
Easily readable markings in millilitres and cups



**100% higiénica**  
100% hygienic

- Jarra fabricada en vidrio borosilicato.
- Sistema de lectura rápida en mililitros y cups.
- Vertedor antigoteo.
- Resistente a choques térmicos.
- Fácil limpieza: apto para el lavavajillas.

- Pichet fabriqué en verre borosilicaté.
- Système de lecture rapide en millilitres et en tasses.
- Bec verseur anti-gouttes.
- Résistant aux chocs thermiques.
- Nettoyage facile : apte pour le lave-vaisselle.

- Jug made of borosilicate glass.
- Easily readable markings in millilitres and cups.
- Non-drip spout.
- Highly resistant to thermal shock
- Easy to clean: dishwasher safe.

Vidrio



Glass Microwave

## Jarra medidora

Pot mesureur  
Mass Behälter  
Measuring jug  
Jarra de medidas

Ref	€	L	U.Venta
67133	11,00	0,5	1

**Sistema de lectura rápida en ml, L y ccm (centímetro cúbico)**  
Easily readable markings in ml, l and ccm (cubic centimeter)

PP



Polypropylene

BPA free

## Jarras medidoras

Pot mesureur  
Mass Behälter  
Measuring jugs  
Jarras de medidas

	Ref	€	Ø (cm)	h (cm)	L	U.Venta
<b>A</b>	67210	3,50	9,0	13,8	0,5	1
<b>B</b>	67211	4,60	12,0	17,0	1,0	1
<b>C</b>	67212	7,90	15,0	20,8	2,0	1
<b>D</b>	67213	10,30	17,0	23,5	3,0	1
<b>E</b>	67214	16,00	20,0	27,5	5,0	1



**Vertedor antigoteo**  
Non-drip spout



### Set 5 jarras medidoras

Setn5 pichets doseurs  
Messbecher, 5 Er-Setr  
Set of 5 measuring jugs  
Conjunto 5 jarras medidas

Ref	€	cm	h (cm)	L	U.Venta
67215	39,90	15x9	15,3	0,5	1
		18x11	18,8	1,0	
		22x15	23,0	2,0	
		24x17	26,0	3,0	
		27x20	30,2	5,0	

Vertedor antigoteo  
Non-drip spout

Jarras apilables  
Stackable jugs

Sistema de lectura rápida en mililitros (ml) , litros (L) y ccm (centímetro cúbico)

Easily readable markings in milliliters (ml), Liters (l) and ccm (cubic centimeter)



Sist. de lectura rápida en mililitros y cups  
Easily readable markings in millilitres and cups



### Jarra medidora

Pot mesureur  
Mass Behälter  
Measuring jug  
Jarra de medidas

Ref	€	L	U.Venta
67136	5,10	0,5	1



### Jarra medidora SPIN

Pot mesureue  
Mass Behälter  
Measuring jug  
Jarra de medidas

Ref	€	L	U.Venta
67165	11,80	0,5	1



Sist. de lectura rápida en mililitros y cups

Easily readable markings in millilitres and cups



Marcajes de capacidad en ml, dl, onzas y cup  
Capacity markings in ml, dl, ounces and cups



### Vaso medidor BASIC

Verre doseur  
Messbecher  
Measuring cup  
Copo medidor

	Ref	€	Ø (cm)	h (cm)	L	U.Venta
A	67075	7,40	8,5	16,0	0,5	1
B	67071	9,60	10,5	19,0	1,0	1

Incluye borde para facilitar el vertido  
Includes rim for easy pouring



Sist. de lectura rápida en litros, mililitros, onzas y cups

Easily readable markings in liters, millilitres, ounces and cups



### Juego 3 jarras medidoras

Ensemble de 3 pot mesureur  
3-tlg. Satz Messbecher  
3 piece measuring jugs  
Jogo 3 jarras de medidas

Ref	€	L	U.Venta
67131	15,20	0,25-0,5-1,0	1





# Set de medición EXACT

new



Raspador · Scraper

6 cazos medidores

6 measuring cups  
(7,5 ml, 15 ml, 60 ml,  
85 ml, 125 ml, 250 ml)

Embudo · Funnel

Jarra medidora

Measuring jug  
(1,0 L / 4 cups)



9  
pcs

- Todas las piezas fabricadas en materiales de máxima calidad, libres de BPA.
- Versátil. Ideal para ingredientes líquidos y secos.
- Jarra con sistema de lectura rápida en litros y cups. Permite comprobar el nivel del líquido mientras se está vertiendo el contenido.
- Cazos marcados en ml y bps para una rápida identificación.

- Toutes les pièces sont fabriquées avec des matériaux de la plus grande qualité, sans BPA.
- Polyvalent, idéal pour les ingrédients liquides et secs.
- Pichet avec système de lecture rapide en Litres et Cups. Permet de vérifier le niveau du liquide tout en versant le contenu.
- Cuillères marquées en ml et bps pour une identification rapide.

- Alle Teile des Sets sind aus Materialien bester Qualität hergestellt, BPA-frei.
- Vielseitig einsetzbar, ideal für flüssige und trockene Zutaten.
- Messkanne mit gut lesbaren Markierungen in Liter und Cups. Füllstand beim Einfüllen der Flüssigkeit ablesbar.
- Löffel mit gut sichtbaren Markierungen in ml und bps.

- All parts made of top quality, BPA-free materials.
- Versatile: ideal for liquid and dry ingredients.
- Jug with easy to see quantities marked in litres and cups and easy to check liquid level while pouring contents.
- Ladles with ml and bps markings for easy reference.

- Todas as peças fabricadas em materiais da máxima qualidade, sem BPA.
- Colheres medidoras marcadas em ml e bps, para uma rápida identificação.
- Jarra com sistema de leitura rápida em litros e chávenas. Permite comprovar o nível do líquido enquanto se verte o conteúdo.
- Versátil, ideal para ingredientes líquidos e secos.

## Set de medición EXACT

Set de mesure  
Messbecher-Set  
Measuring set  
Conjunto de medição



Compacto  
Compact

Ref	€	cm	h (cm)	L	U.Venta
62740	16,00	20x11	13,6	1,0	1

# Set medición & Bol PRACTIC

new



Jarra medidora · Measuring jug (0,5 L)

Jarra medidora · Measuring jug (1,0 L)

Escurreidor · Colander (2,0 L)

Bol mezclador · Mixing bowl (3,5 L)



- Práctico y versátil.
- Fabricadas en polipropileno de máxima calidad. 100% Libre de BPA.
- Jarras medidoras graduadas (mililitros/cups).
- Pequeño vertedor lateral para facilitar el vertido.
- Asas ergonómicas para facilitar el transporte.
- 100% estable gracias a los pies antideslizantes.
- Apilables. Ocupan el mínimo espacio posible.
- Aptas para el lavavajillas.

- Pratique et versatile.
- Fabriqués en polypropylène de la plus grande qualité. 100% sans BPA.
- Verres doseurs gradués (millilitres/cups).
- Petit verseur latéral pour verser plus facilement.
- Poignées ergonomiques pour faciliter le transport.
- 100% stables grâce aux pieds antidérapants.
- Complètement empilables. Prenant ainsi une place très réduite.
- Compatibles lave-vaisselle.

- Practical and versatile.
- Made of top quality polypropylene. 100% BPA free.
- Measuring jugs with graduated ml and cup markings.
- Small side spout for easy pouring.
- Ergonomic handles for easy carrying.
- 100% with non-slip feet.
- Fully stackable. Up as little space as possible.
- Dishwasher safe.

## Set 4 boles PRACTIC

Ensemble de 4 récipients  
Schüsseln, 4er-Set  
Set of 4 bowls  
Conjunto de 4 tigelas

Ref	€	Ø (cm)	h (cm)	L	U.Venta
62633	35,10	11,5	9,3	0,5	1
		14,5	10,6	1,0	
		18,5	13,0	2,0	
		22,0	15,0	3,5	

# Cazos · Cucharas **MEDIDORAS**



**Graduadas y marcadas en ml y tsp**  
Marked and graduated in ml and cups

**Graduadas y marcadas en ml y tsp**  
Marked and graduated in ml and cups

**Inox**  
**18/10**

**Inox** **PP**  
Polypropylene

## Jgo. de 5 cucharas medidoras

Ensemble de 5 cuillères à doser  
Messlöffel-Set 5 Tlg.  
5 piece measuring set  
Jogo de 5 colheres de medidas

## Juego 4 cucharas medidores

Ensemble de 4 cuillères à doser  
Messlöffel-Set 4 Tlg.  
Measuring cup 4 piece  
Jogo de 4 colheres de medidas

Ref	€	ml	U.Venta
67001	10,70	0,62/1,25/2/5/15	1

Ref	€	ml	U.Venta
67037	4,00	1,25/2,5/5/15	1

**Graduadas y marcadas en ml y cups**  
Marked and graduated in ml and cups

**Graduadas y marcadas en ml y cups**  
Marked and graduated in ml and cups

**Inox**  
**18/10**

**Hendidura en un lado para facilitar el vertido**  
A spout on one side makes pouring easy

## Juego 4 cazos medidores

Ensemble de 4 dosettes à doser  
Mass-Pfännchen-Set 4 Tlg.  
Measuring cup 4 piece  
Jogo de 4 caçaroles de medidas

## Juego 5 cazos medidores

Ensemble de 5 dosettes à doser  
Mass-Pfännchen-Set 5 Tlg.  
Measuring cup 5 piece  
Jogo de 5 caçaroles de medidas

Ref	€	ml	U.Venta
67007	11,60	60/80/125/250	4

Ref	€	ml	U.Venta
67036	6,10	60/80/120/180/235	1



## Cuchara medidora digital

Cuillère avec Balance Digital  
Digitale Löffelwaage  
Digital spoon scale  
Colher de pesar Digital

Ref	€	g	L (cm)	U.Venta
62519	39,50	300 (Div.:0,10 g)	28	1

**Inox**  
**18/10**

## Librador

Pelle à farine  
Mehlschaufel  
Ice shovel  
Corredor



**PC**

Polycarbonate

## Librador

Pelle à farine  
Mehlschaufel  
Ice shovel  
Corredor

	Ref	€	ml	Mango (cm)	U.Venta
<b>A</b>	67021	5,70	170	12	1
<b>B</b>	67022	11,60	900	12	1
<b>C</b>	67023	15,90	1800	14	1

Ref	€	ml	L (cm)	A (cm)	U.Venta
67012	17,40	60	19,0	5,0	6
67013	20,30	110	21,5	6,0	6
67014	23,90	200	24,0	7,0	6
67016	26,60	260	25,5	8,5	6
67017	29,50	360	29,0	10,0	6
67018	31,80	470	31,0	11,0	6
67019	39,60	640	35,0	12,5	6
67020	47,40	860	38,0	14,0	6



**Pico vertedor. Vierte el contenido sin derrames**  
Pouring spout. Pour the content no spills

**Pestaña de agarre antideslizante**  
Non-slip grip



**Base 100% antideslizante**  
100% non-slip base

## Set 3 boles GREY

Ensemble de 3 récipients  
Schüsseln, 3er-Set  
Set of 3 bowls  
Conjunto de 3 tigelas

Ref	€	Ø (cm)	h (cm)	L	U.Venta
60054	41,80	21,0	12,5	1,4	1
		26,0	14,2	2,8	
		31,2	14,8	4,7	

- Set de 3 boles de polipropileno de máxima calidad, 100% libres de BPA.
- Versátiles: ideales para mezclar, batir, preparar masas y servir ensaladas o salsas.
- Compuesto por 3 boles perfectamente apilables entre sí.
- Dispone de pico vertedor y pestaña de agarre antideslizante. Base 100% antideslizante.
- Fácil limpieza. No aptos para el lavavajillas.

- Ensemble de 3 bols en polypropylène de la plus grande qualité, 100% sans BPA.
- Polyvalents : parfaits pour mélanger, battre, préparer des pâtes et servir des salades ou des sauces.
- Composé de 3 bols parfaitement empilables entre eux.
- Bec verseur et poignée antidérapante pour une meilleure prise en main. Fond 100% antidérapant.
- Nettoyage facile. Ne convient pas au lave-vaisselle.

- Set of 3 top quality BPA-free polypropylene bowls.
- Versatile: ideal for mixing, whisking, making doughs and serving salads or sauces.
- Comprises 3 perfectly stackable bowls.
- Featuring a pouring spout and non-slip grip. 100% non-slip base.
- Easy to clean. Not suitable for the dishwasher.



## Set 6 boles MULTI

Ensemble de 6 récipients  
Schüsseln, 6er-Set  
Set of 6 bowls  
Conjunto de 6 tigelas

Ref	€	Ø (cm)	h (cm)	L	U.Venta
60055	20,00	10,0	5,0	0,25	1
		14,0	6,8	0,80	
		17,0	8,0	1,15	
		20,3	9,5	2,00	
		24,3	11,0	3,35	
		28,3	12,5	5,25	



- Set de 6 boles de polipropileno de máxima calidad, 100% libres de BPA.
- Versátiles: ideales para mezclar, batir, preparar masas, servir ensaladas o salsas.
- Compuesto por 6 boles perfectamente apilables entre sí.
- Incluye 6 tapas fabricadas en polipropileno, libres de BPA.
- Perfectos para almacenar y conservar los alimentos.
- Fácil limpieza. Cuerpos aptos para el lavavajillas.

- Lot de 6 bols avec couvercles en polypropylène de qualité supérieure, sans BPA.
- Polyvalents : parfaits pour mélanger, battre, préparer des pâtes et servir des salades ou des sauces.
- Composé de 6 bols parfaitement empilables entre eux.
- Comprend 6 couvercles en polypropylène, sans BPA.
- Parfait pour stocker et conserver les aliments.
- Facile à nettoyer. Bols aptes pour le micro-ondes et le lave-vaisselle.

- Set of 6 bowls with lids made of top quality 100% BPA-free polypropylene.
- Versatile: ideal for mixing, whisking, making doughs, serving salads or sauces.
- Comprises 6 perfectly stackable bowls.
- Includes 6 lids made of polypropylene, BPA free.
- Perfect for storing and preserving food.
- Easy to clean. Microwave and dishwasher safe bodies.

# Colección BOLES INOX

Inox



- Set de 3 boles de acero inoxidable de máxima calidad.
- Acabado interior y exterior satinado.
- Versátiles: ideales para mezclar, batir, preparar masas y servir ensaladas o salsas.
- Perfectos para almacenar y conservar los alimentos.
- Compuesto por 3 boles perfectamente apilables entre sí.
- Base 100% antideslizante.
- Incluye 3 tapas herméticas fabricadas en polipropileno, libres de BPA.
- Marcaje de capacidad en el interior (L).
- Fácil limpieza. No aptos para el lavavajillas.

- Ensemble de 3 bols en acier inoxydable de la plus grande qualité.
- Finition intérieure et extérieure satinée.
- Polyvalents : parfaits pour mélanger, battre, préparer des pâtes et servir des salades ou des sauces.
- Parfaits pour ranger et conserver les aliments.
- Composé de 3 bols parfaitement empilables entre eux.
- Fond 100% antidérapant.
- Inclut 3 couvercles hermétiques fabriqués en polypropylène, sans BPA.
- Marquage de capacité à l'intérieur (L).
- Nettoyage facile. Ne convient pas au lave-vaisselle.



- Set of 3 top quality stainless steel bowls.
- Inner and outer satin finish.
- Versatile: ideal for mixing, whisking, making doughs and serving salads or sauces.
- Ideal for storing and preserving food.
- Comprises 3 perfectly stackable.
- 100% non-slip base.
- Includes 3 airtight lids made of BPA-free polypropylene.
- Capacity marks inside (L).
- Easy to clean. Not suitable for the dishwasher.

new



PP



Polypropylene

## Set 3 boles INOX

Ensemble de 3 récipients  
Schüsseln, 3er-Set  
Set of 3 bowls  
Conjunto de 3 tigelas



Ref	€	Ø (cm)	h (cm)	L	U.Venta
60050	46,10	16	10,0	1,5	1
		18	11,0	2,2	
		20	12,5	3,0	

PP



Polypropylene

## Set 3 boles INOX

Ensemble de 3 récipients  
Schüsseln, 3er-Set  
Set of 3 bowls  
Conjunto de 3 tigelas

Ref	€	Ø (cm)	h (cm)	L	U.Venta
60051	62,10	20	12,5	3,0	1
		22	13,5	3,8	
		24	14,0	4,8	

## Bol cónico

Bol conique  
Schüssel, konisch  
Conical mixing bowl  
Bacia cônica

Ref	€	Ø (cm)	h (cm)	L	U.Venta
14016	3,80	16	6,5	0,90	12
14019	5,20	20	7,5	1,40	12
14025	9,40	24	9,0	2,50	1
14029	12,80	30	11,0	4,30	1
14033	17,80	34	13,5	7,50	1
14040	22,70	40	15,5	11,50	1
14046	32,20	45	17,5	17,40	1
14049	37,80	50	19,0	22,60	1

new  
new  
new

**GAR INOX**



Diseño cónico con base estable  
Conical design with stable base



# Colección CALDEROS INOX

Inox  
18/10



Dishwasher



## Caldero semiesférico s/asas

Bassine hemispherique s/anses  
Schnees Schlagkessel ohne Griffe  
Semi-spherical mixing bowl wout/handles  
Bacia semi-esférica sem asas

Ref.	€	Ø (cm)	h (cm)	L	U.Venta
50323S	36,50	22	11,0	2,70	1
50327S	42,60	26	13,0	4,00	1
50333S	57,20	32	17,0	9,50	1
50337S	64,90	36	18,0	12,00	1
50341S	108,90	40	21,0	14,50	1



## Caldero semiesférico c/asas

Bassine hemispherique a/anses  
Schnees Schlagkessel mit Griffe  
Semi-spherical mixing bowl w/handles  
Bacia semi-esférica com asas

Ref.	€	Ø (cm)	h (cm)	L	U.Venta
50323	48,10	22	11,0	2,70	1
50327	54,70	26	13,0	4,00	1
50333	70,30	32	17,0	9,50	1
50337	75,60	36	18,0	12,00	1
50341	108,10	40	21,0	14,50	1



## Caldero cónico

Bassine conique  
Wanne  
Mixing bowl  
Bacia cónica

Ref	€	Ø (cm)	h (cm)	L	U.Venta
60013	12,40	13	6,1	0,55	1
60016	13,40	16	9,1	1,00	1
60020	18,40	20	11,7	2,12	1
60024	22,10	24	12,6	3,50	1
60028	27,60	28	13,4	5,25	1
60032	31,00	32	15,0	7,65	1
60036	42,90	36	16,0	11,00	1
60040	49,80	40	18,0	15,00	1

- Ideal para mezclar los alimentos.
- Para uso profesional o doméstico.
- Fabricados en acero inoxidable 18/10, material muy resistente a la corrosión y ácidos alimentarios.
- Fácil limpieza: apto para el lavavajillas.

- Idéal pour mélanger les aliments.
- Pour un usage professionnel ou domestique.
- Fabriqué en acier inoxydable 18/10, un matériau hautement résistant à la corrosion et aux acides alimentaires.
- Nettoyage facile : passe au lave-vaisselle.

- Ideal zum Mischen von Speisen.
- Für den professionellen oder privaten Gebrauch.
- Hergestellt aus Edelstahl 18/10, einem Material mit hoher Beständigkeit gegen Korrosion und Lebensmittelsäuren.
- Einfache Reinigung: Spülmaschinenfest.

- Ideal for mixing food.
- For professional or home use.
- Made of 18/10 stainless steel, a material highly resistant to corrosion and food acids.
- Easy cleaning: dishwasher safe.

- Ideal para misturar alimentos.
- Para uso profissional ou doméstico.
- Fabricado em aço inoxidável 18/10, um material altamente resistente à corrosão e aos ácidos alimentares.
- Fácil limpeza: lavável na máquina de lavar louça.

## Soporte de calderos s/esféricos

Support cul de poule  
Ringständer  
Bowl stand  
Suporte de bacias semi-esféricas



Ref.	€	U.Venta
50300	25,70	1



## Caldero cónico c/asas

Bassine conique à anses  
Wanne mit Griffe  
Conical mixing bowl  
Bacia cónica con asas

Ref.	€	Ø (cm)	h (cm)	L	U.Venta
50828	43,10	28	13,2	5,00	1
50832	47,80	32	14,5	7,00	1
50836	54,70	36	16,0	11,00	1
50840	60,80	40	18,0	15,00	1
50845	72,60	45	20,0	22,00	1
50850	87,10	50	21,0	30,00	1

# Colección CEDAZOS INOX

Inox  
18/10  
Dishwasher



## Cedazo

Tamis  
Mehlsieb  
Sieve  
Peneira

Hilos por pulgada - Wires-inch= 50			Hilos por pulgada - Wires-inch= 35			Hilos por pulgada - Wires-inch= 25			Hilos por pulgada - Wires-inch= 20		
Ref	€	Ø (cm)	Ref	€	Ø (cm)	Ref	€	Ø (cm)	Ref	€	Ø (cm)
68058	38,50	18	68350	38,70	20	68250	38,40	20	68026	60,60	26
68050	42,10	20	68357	58,30	26	68252	57,90	26	68023	67,50	30
68057	58,40	26	68351	66,00	30	68253	64,40	30	68024	101,80	40
68053	70,40	30	68354	98,70	40	68254	99,70	40			
68054	96,10	40									



## Cedazo 4 mallas intercambiables

Tamis à 4 mailles interchangeables  
4 Austauschbare Masche-Sieb  
Mesh sieve interchangeable  
Peneira de 4 malha intercambiáveis

Ref	€	Ø (cm)	U.Venta
68340	33,00	20	1
68341	39,80	23	1
68342	49,40	25	1



20 orificios/pulgada · 20 eyes/inch

Mecanismo en el asa en forma de gatillo  
Trigger handle mechanism

Ideal para harina, chocolate en polvo, levaduras, etc.  
Ideal for flour, chocolate powder, yeasts, etc.

Inox

## Cribador de harina

Tamis  
Mehlsieb  
Flour sifter  
Crivador de farinha

Ref	€	Ø (cm)	Kg	U.Venta
67011	10,60	10,0	0,35	5
67015	14,10	12,0	0,50	1



Ideal para harina, chocolate en polvo, levaduras, etc.  
Ideal for flour, chocolate powder, yeasts, etc.

Mecanismo en el asa en forma de gatillo  
Trigger handle mechanism

AS

Plastic



## Cribador de harina

Tamis  
Mehlsieb  
Flour sifter  
Crivador de farinha

Ref	€	Ø (cm)	Kg	U.Venta
67025	7,20	10	0,35	6



# Colección BATIDORES

Inox  
18/10



Dishwasher

Inox

## Batidor MINI

Mini fouet Inox  
Mini-Schneebeesen  
Mini whisk  
Mini batedor Inóx

Ref	€	L (cm)	U.Venta
61615	5,40	15	12
61620	6,00	20	12



## Batidor EXTRA 8

Fouet inox extra 8  
Schneebeesen, Extra 8  
Extra 8 whisk  
Batedor Extra 8

Ref	€	L (cm)	U.Venta
61625	8,50	25	6
61630	8,70	30	6
61635	9,10	35	6
61640	10,00	40	6
61645	10,80	45	6
61650	12,10	50	6
61655	12,80	55	6
61660	13,80	60	6



## Batidor SUPER 12

Fouet inox super 12  
Schneebeesen, super 12  
Super 12 whisk  
Batedor Super 12

Ref	€	L (cm)	U.Venta
61626	7,80	25	6
61631	8,40	30	6
61636	9,10	35	6
61641	9,60	40	6
61646	9,90	45	6
61651	10,80	50	6



SI 250°C

Silicone

max



## Batidor varilla silicona

Fouet en silicone  
Rührbesen auf Silikon  
Silicone wire whisk  
Batedor vareta silicone

Ref	€	L (cm)	U.Venta
61621	8,00	20	12
61622	8,90	25	6
61623	9,90	30	12

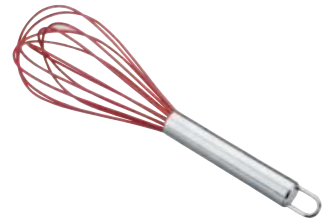

## Batidor FIBREGLASS

Fouet  
Schneebeesen  
Whisk  
Batedores

Ref	€	L (cm)	U.Venta
61624	11,80	25	6
61629	13,60	30	6
61634	15,40	35	6
61639	17,00	40	6
61644	20,40	45	6
61649	21,40	50	6



Ergonómico  
Ergonomic

SI 250°C

Silicone

max



## Batidor silicona FIBREGLASS

Fouet en silicone  
Schneebeesen, Silikon  
Silicone whisk  
Batedores silicona

Ref	€	L (cm)	U.Venta
61524	10,80	25	6
61529	11,70	30	6
61534	13,60	35	6



Ergonómico  
Ergonomic

- Batidor de varilla con práctico raspador de silicona incorporado.
- 2 en 1: bate y recoge toda la mezcla del bol de forma fácil y rápida.
- Varillas fabricadas en acero inoxidable (Ø 2 mm).
- Espátula de silicona inyectada en una de las varillas (certificado LFGB y libre de BPA).

- Blade mixer with practical built-in silicone scraper.
- 2 in 1: Beat and scrape out the entire mixture from the bowl quickly and easily.
- Blades made of stainless steel (Ø 2 mm).
- Silicone spatula injected into one of the blades (LFGB certified and BPA free).



### Batidor de varillas con raspador de silicona

Fouet avec grattoir en silicone  
Schneebeesen mit Silikonschaber  
Whisk with built-in silicone  
Batedeira de varas com raspador de silicone

Ref	€	L (cm)	U.Venta
61627	6,20	32	12



### Batidor varilla con espátula

Fouet avec grattoir  
Schneebeesen mit Schaber  
Whisk with spatula  
Batedeira de varas com espátula

Ref	€	L (cm)	U.Venta
68199	5,90	27	1



### Batidor gigante

Fouet à purée  
Kesselbesen  
Big whisk  
Batedor gigante

Ref.	€	cm	Ø Varilla (mm)	U.Venta
60610	62,40	100	3	12
60612	80,00	129	3	12

Inox

### Batidor manivela

Batteur-mélangeur à manivelle  
Schneequirl  
Egg beater  
Batedor de manivela

Ref	€	U.Venta
62901	19,10	6



### Batidor capuccino

Batteur pour cappuccino  
Capuccino- Mixer  
Capuccino mixer  
Batedor capuccino

Ref	€	W	U.Venta
69041	26,70	2,7	1





# Espátulas SILICONA



## Espátula silicona

Spatule en silicone  
Teigschaber  
Silicone spatula  
Espátula de silicone

	Ref	€	L (cm)	U.Venta
A	64450	5,60	25	6
	64451	8,90	35	6
B	64460	5,80	25	6
	64461	9,70	35	6



## Espátula silicona GREY

Spatule en silicone  
Teigschaber  
Silicone spatula  
Espátula de silicone

	Ref	€	L (cm)	U.Venta
	67434	4,70	30	12
	67435	5,40	29	12



## Espátula UNITE

Spatule  
Backschauffel  
Spatule  
Espátula

	Ref	€	cm	L (cm)	U.Venta
	68195	4,30	5,6x8,5	26,5	1



## Espátula silicona WHITE

Spatule en silicone  
Teigschaber  
Silicone spatula  
Espátula de silicone

	Ref	€	L (cm)	U.Venta
	67421	4,60	20	1
	67427	6,80	26	1
	67433	14,90	32	1

## Espátula silicona

Spatule en silicone  
Teigschaber  
Silicone spatula  
Espátula de silicone

	Ref	€	L (cm)	U.Venta
A	64444	5,90	28	1
B	64445	6,60	30	1
C	64446	6,70	31	1



## Set repostería (20 pcs.)

Exposant pâtisserie  
Aufsteller Pastry  
Pastry display  
Expositor pastelaria

	Ref	€	L (cm)	Pieza	U.Venta
A	64424	78,30	-	Caja (20 pcs) · Set (20 pcs)	1
B	64426	4,00	23,0	Pincel · Brush	12
C	64427	4,00	23,0	Espátula · Spatula	12
D	64428	4,00	23,0	Lengua gato · Spatula	12
E	64429	4,00	23,0	Batidor · Whisk	12

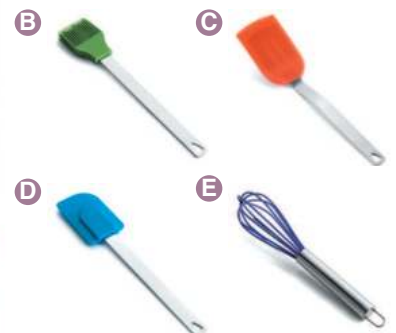

# Colección GREY & OCEAN



- Fabricados en silicona de alta calidad libre de BPA.
- Núcleo reforzado para una mayor resistencia sin perder flexibilidad en los bordes. Diseñados en una sola pieza, sin costuras ni grietas.
- Resistentes a altas temperaturas.
- Mango ergonómico suave al tacto y antideslizante.
- No rayan ni dañan artículos de cocina con antiadherente.
- Fáciles de limpiar. Aptos para el lavavajillas.

- Fabriqués en silicone de haute qualité sans BPA.
- Noyau renforcé pour une résistance accrue sans perte de flexibilité des bords. Conception monobloc, sans coutures ni fissures.
- Résistant aux hautes températures.
- Poignée ergonomique, douce au toucher et antidérapante.
- Ne raye pas et n'endommage pas les ustensils de cuisine antiadhésifs.
- Facile à nettoyer. Lavable au lave-vaisselle.

- Aus hochwertigem Silikon, BPA-frei.
- Verstärkter Kern für mehr Widerstand, flexible Schale. Sehr hitzebeständig.
- Ergonomischer Griff, angenehmes Handgefühl, rutschfest.
- Aus einem Stück gefertigt, ohne Nähte, ohne Spalten.
- Verkratzt oder beschädigt nie wieder die Antihafbeschichtung von Pfannen oder Töpfen.
- Leichte Reinigung. Spülmaschinengeeignet.

- Made of high quality BPA free silicone.
- Reinforced core improves strength without losing flexibility around the edges. Designed in a single piece without seams or cracks.
- Can withstand high temperatures.
- Soft and non-slip ergonomic handle.
- Does not scratch cooking utensils with non-stick coating.
- Easy to clean. Dishwasher safe.

- Fabricado em silicone de alta qualidade, sem BPA.
- Núcleo reforçado para uma maior resistência, sem perda de flexibilidade nas bordas. Design de uma única peça, sem costuras nem gretas.
- Resistente a altas temperaturas.
- Cabo ergonómico, suave ao tato e antideslizante.
- Não risca nem danifica os artigos de cozinha com revestimento antiaderente.
- Fácil de limpar. Aptos para máquinas de lavar louça.



## Utensilios GREY

Utensiles en silicone  
Silikonutensilien  
Silicone utensils  
Utensílios de silicone

	Ref	€	L (cm)	U.Venta	
	64459	15,60	27,5	1	<b>Set 3 utensilios</b> · Set 3 utensils
<b>A</b>	64463	5,50	27,5	1	<b>Cuchara</b> · Spoon
<b>B</b>	64464	5,50	27,5	1	<b>Espátula</b> · Spatula
<b>C</b>	64465	5,60	27,5	1	<b>Pincel</b> · Brush

new



## Utensilios OCEAN

Utensiles en silicone  
Silikonutensilien  
Silicone utensils  
Utensílios de silicone

	Ref	€	L (cm)	U.Venta	
	64452	16,70	27,5	1	<b>Set 3 utensilios</b> · Set 3 utensils
<b>A</b>	64453	5,80	27,5	1	<b>Cuchara</b> · Spoon
<b>B</b>	64454	5,80	27,5	1	<b>Espátula</b> · Spatula
<b>C</b>	64455	5,80	27,5	1	<b>Pincel</b> · Brush

# Colección PINCELES



## Pincel virola inox mango polipropileno

Pinceau patisier v. inox m. polipropylene  
Fett-/Kuchenpinsel, mit Stiel aus Polypropylen, schaft Edelstahl  
Flat pastry brush s.steel polypropylene handle  
Pincel aro Inóx cabo polietileno

Ref	€	L (cm)	Cerdas (cm)	U.Venta
64430	4,30	23,0	4,4x3,0	1
64435	5,00	24,0	4,4x3,5	1
64440	5,20	24,5	4,4x4,0	1
65044	6,40	25,0	5,0x4,5	1
65050	7,70	26,0	5,0x5,0	1

- Para cocina o repostería.
- Prácticas espátulas o lenguas de gato para rebañar boles, cazuelas, fuentes, etc.
- Pinceles ideales para pincelar con aceites o salsas, marinar carnes o pescados, engrasar moldes, untar con aceite, huevo batido, almíbar, etc.
- No absorben olores ni sabores.

- Pour la cuisine ou la pâtisserie.
- Pratiques spatules ou langues de chats pour récupérer les éléments restant dans les bols, casseroles, etc.
- Pinceaux parfaits pour badigeonner de l'huile ou des sauces, mariner des vandes ou des poissons, graisser des moules, étaler de l'huile, de l'œuf battu, du sirop, etc.
- N'absorbent ni les odeurs ni les goûts.

- Zum Kochen oder Backen.
- Praktische Spachtel oder Schaber zum auskratzen von Schalen, Kasserollen, Schüsseln, etc.
- Pinsel ideal zum Einstreichen mit Öl, Sauce, Marinieren von Fleisch oder Fisch Einfetten von Backformen, zum Einölen, zum Bestreichen mit Ei oder Sirup usw.
- Nehmen weder Geschmack noch Geruch an.

- For cooking or baking.
- Practical spatulas for scraping bowls, pots, dishes, etc.
- Brushes ideal for brushing oils or sauces, marinating meat or fish, greasing baking tins, and basting with oil, egg, syrup, etc.
- Doesn't absorb smells or tastes.

- Para cozinha ou pastelaria.
- Prácticas espátulas ou linguas de gato para barrar boles, caçarolas, formas e travessas, etc.
- Pinceles ideais para pincelar com óleos ou molhos, marinar carnes ou peixes, untar formas, untar com óleo, ovo batido, caldas, etc.
- Não absorvem odores nem sabores.

Dimensiones Reales · Real Dimensions

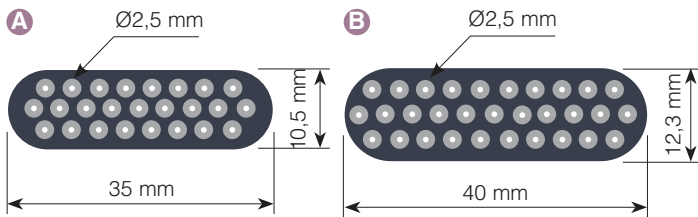

## Pincel de silicona mango inox

Pinceau de cuisine embout en silicone  
Silikonpinsel, langer stiel  
Silicone brush st.steel long handle  
Pincel de silicone cabo inóx

Ref	€	L (cm)	U.Venta
A 64425	6,80	24	12
B 64431	7,20	24	12



## Pincel de silicona

Pinceau en silicone  
Silikonpinsel,  
Silicon brush  
Pincel de silicone

Ref	€	L (cm)	U.Venta
64441	6,70	23	1



**HAYA**  
Beech  
Wood

## Pincel UNITE

Pinceau  
Silikonpinsel  
Brush  
Pincel

Ref	€	cm	L (cm)	U.Venta
68196	4,10	5,5x0,5	24,5	1



**Inox**  
18/10

## Pincel de silicona

Pinceau en silicone  
Silikonpinsel  
Silicon brush  
Pincel silicone

Ref	€	L (cm)	U.Venta
A 64418	10,80	22	1
B 64422	12,10	23	1



# Colección RASQUETAS



Inox	PP	Si	Fibra de vidrio
	Polypropylene	Silicone	Fibre glass

*new*

- Cortador de masa fabricado en acero inoxidable de máxima calidad con escalas de medición en cm e in. Dispone de un mango antideslizante y ergonómico. Diseñado para cortar, dividir y formar masas, así como recoger harinas, etc.
- Espátula de silicona flexible de gran calidad. Ideal para el empleo en superficies poco uniformes, como boles esféricos.
- Raspador fabricado en polipropileno + fibra de vidrio de grado alimenticio y diseñado principalmente para decorar tartas y pasteles de forma práctica y sencilla.
- Duraderos y resistentes. Se limpian fácilmente. Aptos para el lavavajillas. Libres de BPA.

- Dough cutter made of top quality stainless steel with measurements marked in cm and inches. It has a non-slip ergonomic handle. It's designed to cut, divide and shape dough or pick up flour, etc.
- High quality flexible food safe silicone spatula, perfect for using on uneven surfaces like spherical bowls.
- Scraper made of food grade Polypropylene + Glass fiber mainly designed for decorating cakes and pies in a simple and easy way.
- Strong and long lasting, easy to clean and dishwasher safe. BPA free.



## Rasqueta

Coupe pate  
Schaber  
Scraper  
Raspador

Ref	€	cm	U.Venta
67041	25,10	13,8x13	1

Diseño apilable  
Stackable design

- Amasan, cortan y limpian.
- Indispensables a la hora de trabajar con masas.
- Nos ayudan a mover y cortar el amasado gracias a su filo.
- Gran ayuda a la hora de limpiar la superficie de trabajo eliminando los restos.

- They knead, cut and cleaning.
- Indispensables when working with mass.
- We help both move in the kneading and cutting edge thanks to its.
- Great help when cleaning the working surface by removing debris.



## Rasqueta

Coupe pate  
Schaber  
Scraper  
Raspador

Escala de medición  
Measurement scale

Ref	€	cm	U.Venta
67029	9,40	16,5x10,5	6

SI 230°C  
Silicone max



## Rasqueta silicona

Coupe pate en Silicone  
Schaber, Silikon  
Silicone scraper  
Raspador silicone

Ref	€	cm	U.Venta
67414	8,90	9x15	1

Inox  
18/10



## Rasqueta

Coupe pate  
Schaber  
Scraper  
Raspador

	Ref	€	cm	U.Venta
A	67005	12,80	15x9	6
B	67006	12,40	15x9	6

# Colección RODILLOS AMASAR

Inox  
18/10



Dishwasher



(A) LONGITUD TOTAL · Total length  
(B) LONGITUD ZONA DE USO · Length area of use

- Ideal para extender pequeñas cantidades de masa.
- Acabado uniforme para trabajar pastas, mazapán, fondant, etc.

- Idéal pour étaler de petites quantités de pâte.
- Finition uniforme pour travailler des pâtes, du massepain, des fondants, etc.

- Ideal, um kleinen Mengen Teig auszurollen.
- Gleichmäßiges Finish für die Zubereitung von Keksen, Marzipan, Fondant usw.

- Perfect for spreading small quantities of dough.
- Uniform nish when working with pastries, marzipan, fondant, etc.

- Ideal para estender pequenas quantidades de massa.
- Acabamento uniforme, para trabalhar bolachas, maçapão, fondant, etc.



## Rodillo

Rouleau patisier  
Teigroller  
Rolling pin  
Rolo

Ref	€	A (cm)	ØxB (cm)	U.Venta
67140	42,00	40	Ø5x20	3
67148	46,80	48	Ø6,3x25	4
67156	50,00	56	Ø6,3x33	4



## Rodillo

Rouleau patisier  
Teigroller  
Rolling pin  
Rolo

Ref	€	A (cm)	ØxB (cm)	U.Venta
67149	48,60	48	Ø6,3x25	4

**Ideal para pasta de azúcar y fondant**  
Ideal for sugar paste and fondant

PE

Polyethylene

## Rodillo de amasar

Rouleau à pâtisserie  
Teigroller  
Rolling pin  
Rolo de amasar

Ref	€	Ø (cm)	L (cm)	U.Venta
68141	35,60	4,4	43,0	1
68151	43,50	4,8	50,0	1

HAYA

Beech Wood Dishwasher



## Rodillo de madera de haya c/mango

Rouleau pâtisier en hêtre a/poignee  
Teigroller, Buchenholz  
Beechwood rolling pin with handle  
Rolo de madeira de faia com cabo

Ref	€	A (cm)	B (cm)	U.Venta
68153	11,00	50	30	1
68154	20,80	60	40	1

HAYA

Beech Wood Dishwasher



## Rodillo de madera de haya

Rouleau pâtisier en hêtre  
Teigroller, Buchenholz  
Beechwood rolling pin  
Rolo de madeira de faia

Ref	€	Ø (cm)	L (cm)	U.Venta
68142	9,70	4,4	43	1
68150	10,20	4,8	50	1

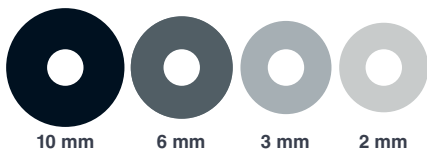

Guía para medir el ancho de la masa  
Guide to measure the width of the dough



### Rodillo amasar con anillas

Rouleau hêtre avec anneaux  
Teigroller mit Ringen  
Rolling pin with guide rings  
Rolo com anilhas

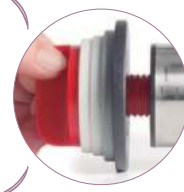

4 discos extraíbles  
4 removable discs

	Ref	€	Anillas	L (cm)	Material	U.Venta
A	67142	15,30	10/6/2	38	HAYA	1
B	67143	15,90	10/6/3/2	38	INOX	1

Anillas de polipropileno  
Polypropylene rings

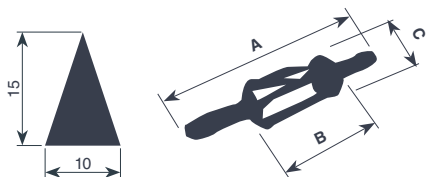

### Rodillo cortador croissant

Rouleau pour coupe croissant  
Schneidewalze für Croissantteig  
Croissant dough cutter wheel  
Rolo cortador de croissants



Ref	€	A (cm)	B (cm)	C (Ø cm)	U.Venta
68161	33,40	40,5	15,3	7,7	1

### Rodillo picar pasta

Rouleau pique vite pointe metal  
Teig-Gitterschneider  
Roller docker metal  
Rolo de picar massas



Ref	€	L (cm)	U.Venta
68213	36,40	13	6

## Sets CORTAPASTAS

Inox  
18/10



### Caja de 9 cortapastas redondos

Boîte de 9 découpoirs ronds unis  
9 TLG. Teigausstecher, rund, glatt  
Set of 9 round dough cutters  
Caixa de 9 corta-massas ovais redondos

Ref	€	h (cm)	U.Venta	
68069	27,70	4,2	1	Liso · Pain
68070	30,10	4,2	1	Rizado · Fluted

#### Medidas

Sizes (cm): Ø2 / Ø3 / Ø4 / Ø5 / Ø6 / Ø7 / Ø8 / Ø9 / Ø10

- Hoja · Leave
- Ángel · Angel
- Palote · Candy cane
- Campanilla · Bell
- Osito · Teddy bear
- Muñeco nieve · Snow man
- Abeto · Christmas tree
- Adorno · Decoration

### Set 8 cortadores galletas

Set 8 emporte-pièces  
8-Tlg. Ausstechformen  
Cookies cutters set  
Set 8 cortadores de biscoito

Ref	€	Ø (cm)	U.Venta
68087	16,40	5	1



PA

40°C

Nylon

max



### Caja de 9 cortapastas redondos

Boîte de 9 découpoirs ronds unis  
9 TLG. Teigausstecher, rund, glatt  
Set of 9 round dough cutters  
Caixa de 9 corta-massas ovais redondos

Ref	€	h (cm)	U.Venta	
68091	25,10	3,50	1	Liso · Pain
68092	25,10	3,50	1	Rizado · Fluted

#### Medidas

Sizes (cm): Ø2 / Ø3 / Ø4 / Ø5 / Ø6 / Ø7 / Ø8 / Ø9 / Ø10

Inox

### Cortapastas extensible

Rouleau multicouper  
Teigschneider  
Dough divider expandable  
Corta-massas extensível

Ref	€	U.Venta
68246	51,10	1



Cerrado · Closed: 5,5x24 cm  
Abierto · Open: 49,5x24 cm  
Cuchillas · Blades: Ø5,5 cm

# Sello estampa GALLETAS



Dale un toque original · Add a touch of originality

Incluye cortapastas  
Includes cookie cutter



- Conjunto de 5 originales sellos de silicona intercambiables.
- Mango de madera para un perfecto agarre.
- Silicona de máxima calidad. Libre de BPA.
- Garantiza la completa seguridad alimentaria del producto.

- Set de 5 tampons en silicone originaux interchangeables.
- Manche en bois pour une prise en main parfaite.
- Silicone de la plus grande qualité. Sans BPA.
- Garantit une sécurité alimentaire totale du produit.

- 5-teiliges Stempelset mit austauschbaren Silikonaufsetzen.
- Mit handlichem Holzgriff.
- Sehr hochwertiges Silikon. BPA-frei.
- Garantiert die vollständige Lebensmittelsicherheit des Produkts.

- Set of 5 original interchangeable silicon stamp.
- Wood handle for perfect grip.
- Top quality silicone. BPA free.
- Guarantees complete food safety of the end product.

- Conjunto de 5 originais carimbos de silicone intercambiáveis.
- Pega de madeira para melhor sujeição.
- Silicone da máxima qualidade. Livre de BPA.
- Garante uma completa segurança alimentar do produto.

## Sellos para galletas SWEET

Tampons pour biscuits  
Keksstempel  
Biscuit stamp  
Carimbos para bolachas

Ref	€	Sellos	U.Venta
68099	13,20	5	1

# Peines · Estacas DECORACIÓN



## Rasqueta decoración

Grattoir à pate  
Teigschaber  
Dough scrape  
Raspador de masa



Ref	€	mm	U.Venta
68132	1,70	155x105	24

## Peine decoración

Peigne du decoration  
Verzierungskamm  
Decorating comb  
Pente de decoração



Ref	€	mm	U.Venta
68136	1,50	110	24



## Juego peines decoración

Set peigne du decoration  
Verzierungskamm-Set  
Decorating comb set  
Jogo pente de decoração

Ref	€	Piezas	U.Venta
68137	5,80	7	1

## ABS

Plastic



## Estacas decoración fondant

Outils de modelisation de fondant  
Fondant Modellerset  
Fondant modeling tools  
Ferramentas demodelagen fondant

Ref	€	Piezas	U.Venta
68090	11,20	12	1

# Aerógrafo con compresor **DECORACIÓN**

Inox



**Permite obtener detalles únicos en creaciones artísticas de repostería**

Lets you get unique details on artistic bakery creations

- Ideal para la decoración de tartas, galletas, cupcakes, bombones, etc.
- Permite obtener detalles únicos en creaciones artísticas de repostería.
- El kit contiene: compresor, aerógrafo y tubo conector.
- Compresor con regulador de presión de aire.
- 0-2 bares y con un caudal de 0-10 L/min.
- Aerógrafo por gravedad de doble acción con aguja de salida de 0,3 mm.
- Depósito de pintura metálico con capacidad de 7 ml.
- Incluye una caja acolchada para almacenar el aerógrafo.

- Idéal pour la décoration de gâteaux, biscuits, cupcakes, chocolats, etc.
- Permet d'obtenir des détails uniques sur des créations artistiques de pâtisserie.
- Le kit contient : compresseur, aéropgraphe et tuyau connecteur.
- Compresseur avec régulateur de pression d'air.
- 0-2 bars et avec un débit de 0-10 L/min.
- Aéropgraphe par gravité à double action avec aiguille de sortie de 0,3 mm.
- Réservoir de peinture métallique d'une capacité de 7 ml.
- Inclut une boîte matelassée pour ranger l'aéropgraphe.

- Ideal zur Dekoration von Torten, Keksen, Muffins, Pralinen usw.
- Kreiert kunstvolle und einzigartige Details auf Feingebäck.
- Lieferumfang: Kompressor, Airbrush Spritzpistole, Verbindungsschlauch.
- Kompressor mit einem einstellbaren Arbeitsdruck von.
- 0-2 Bar und einer Durchflussmenge von 0-10 l/min.
- Airbrush Spritzpistole mit Doppelfunktion und einer Düsenstärke von 0,3 mm.
- 7 ml Farbbehälter aus Metall.
- Mit gepolsterter Aufbewahrungsbox für die Spritzpistole.

- Perfect for decorating cakes, biscuits, cupcakes, bonbons, etc.
- Lets you get unique details on artistic bakery creations.
- The set contains: Compressor, airbrush and air hose.
- Compressor with air pressure regulator.
- 0-2 bars with a 0-10 l/min flow.
- Double action gravity feed airbrush with a 0.3 mm needle.
- Metal paint cup with a 7 ml capacity.
- Includes a padded box for storing the airbrush.

- Ideal para decorar tartes, bolachas, cupcakes, bombons, etc.
- Permite criar pormenores únicos em trabalhos artísticos de pastelaria.
- O kit inclui: compressor, aerógrafo e tubo conector.
- Compresor com regulador de pressão de ar.
- 0-2 bares, com um caudal de 0-10 l/min.
- Aerógrafo por gravidade, de dupla ação, com agulha de saída de 0,3 mm.
- Depósito de pintura metálico com capacidade para 7 ml.
- Inclui uma caixa acolchoada para guardar o aerógrafo.



## Soporte

Soporte para aerógrafo de 360° para un uso práctico

360° airbrush stand for practical use

## Regulador de aire

Aumenta y disminuye el caudal de salida

Increase and decrease the output flow

## Compresor

Provee o inyecta el aire en el aerógrafo

Provides and feeds air into the airbrush

## Ampolla de recarga

### Llave

Ampolla; recarga de pintura Llave; monta/desmonta la boquilla

Flask, paint refill  
Spanner, assemble/disassemble the nozzle

## Aerógrafo

Genera un fino chorro de pintura para recubrir superficies o realizar dibujos mediante la palanca Depósito de 7 ml

Creates a fine spray of paint for covering surfaces or making drawings by lever 7 ml tank

## Tubo conector (1,8 m)

Manguera textil flexible con dos conexiones que traslada el aire del compresor al aerógrafo

Flexible cloth hose with two connections that carries air from the compressor to the airbrush

## Aerógrafo con compresor

Aéropgraphe avec compresseur

Airbrush Spritzpistole mit Kompressor

Airbrush with compressor

Aerógrafo com compressor

Ref	€	W	Presión	Caudal	U.Venta
69450	103,20	20	0 - 2 bar	0 - 10 L/min	1

Ref	Tensión Voltage	Potencia Power	Presión Pressure	Caudal aire Air flow	Capacidad Capacity	Long. tubo aire Air tube length	Aerógrafo Airbrush	Med. compresor Compressor size	Peso Weight
69450	220-240 V ; 50/60 Hz	20 W	0 - 2 bar	0 - 10 L/min	7 ml	1,80 m	14,2x2,5x9	11,5x13,5x6 cm	800 g



# Colección PISTOLAS GAS

Inox  
18/10



- Autoencendido por piezoeléctrico.
- Control ajustable de llama.
- Llama antiretorno.
- Sistema seguro de bloqueo.
- Fácil rellenado de gas butano.



- Auto-allumage par piézoélectrique.
- Contrôle de flamme réglable.
- Flamme antiretour.
- Système de blocage sécurisé.
- Facile remplissage de gaz butane.



- Selbsttätige piezoelektrische Zündung.
- Einstellbare Flamme.
- Anti-Rückschlag-Flamme.
- Sicherheitsverriegelung.
- Einfache Butangas-Nachfüllung.



- Auto power by piezoelectric sensor.
- Adjustable flame control.
- Non-return flame.
- Safe stop system.
- Easy filling of butane gas.

- Autoignição piezoelétrica.
- Controlo de chama ajustável.
- Chama anti-retorno.
- Sistema seguro de bloqueio.
- Fácil de encher com gás butano.



## Pistola gas repostería

Torche à caraméliser  
Gasbrenner  
Pastry gas torch  
Queimadora a gás para pastelaria



	Ref	€	Cap. (ml)	h (cm)	U.Venta	
<b>A</b>	68981	18,90	5-6	12,50	1	Micro
<b>B</b>	68982	30,70	19	17,00	1	Mini
<b>C</b>	68983	41,80	65	18,00	1	Chef
<b>D</b>	68988	53,20	40	16,00	1	Profesional



## Pistola gas repostería

Torche à caraméliser  
Gasbrenner  
Pastry gas torch  
Queimadora a gás para pastelaria

Cuando el orificio de entrada de oxígeno este descubierto, la llama será más intensa

When the oxygen inlet is uncovered, the flame will be more intense



Válvula recarga gas  
Refill valve

	Ref	€	Cap. (ml)	h (cm)	U.Venta
	68969	22,10	21	13,00	1

# Colección sopletes · Quemador **PROFESIONAL**



**Adaptador para poder utilizar distintos tipos de botellas de gas**  
Adapter enables it to be used with different types of gas bottles



## Cabezal soplete gas + adaptador **PROFESIONAL**

Torche à caraméliser + adaptateur  
Gasbrenner-Aufsatz + Adapter  
Blow torch head + adapter  
Queimadora a gás + adaptador

Ref	€	W	Consumo (g/h)	U.Venta
68974	25,20	1,65	120	1

**Botella de gas NO incluida** · Gas of bottle NOT included

## Cabezal soplete gas **PROFESIONAL**

Torche à caraméliser  
Gasbrenner-Aufsatz  
Blow torch head  
Queimadora a gás

Ref	€	W	Consumo (g/h)	U.Venta
68984	16,30	1,65	120	1

**Botella de gas NO incluida** · Gas of bottle NOT included



**GAS No incluido**  
Not included

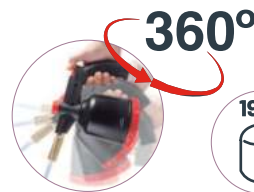

- Recargable con cartuchos universales de gas tipo C200 (190g) (No incluido).
- Encendido piezoeléctrico.
- Flujo ajustable.
- Función de precalentamiento integrada que garantiza una configuración de llama óptima.
- Sistema 360°; permite el uso en cualquier posición y siempre con llama constante.
- Sistema de bloqueo de seguridad.
- Mango ergonómico de polipropileno resistente a altas temperaturas y golpes.

## Soplete gas **PROFESIONAL**

Torche à caraméliser  
Brullerbrenen  
Blow torch  
Queimador a gás

Ref	€	Kw	Temp.	g/h	U.Venta
68968	31,00	1,7	1300°C	123	1

**Válido para gas butano, NO gas natural** · Valid for butane gas, NOT natural gas

- Refillable with universal type C200 (190 g ) gas cartridges (not included).
- Piezoelectric ignition.
- Adjustable flow.
- Built in pre-heating function that guarantees optimal flame configuration.
- The 360° System lets you use the torch in any position and always with a constant flame.
- Safety locking system.
- Ergonomic polypropylene handle that can withstand high temperatures and impacts.

Inox  
18/10



## Quemador eléctrico redondo

Fer à caraméliser électrique rond  
Karamellisierer rund  
Round electric caramelize  
Queimador eléctrico redondo

Ref	€	U.Venta
68651	114,70	1
68652	132,40	1



**Incluye soporte**  
Includes support

Ref	Tensión/Voltage	Potencia/Power	Dimensiones/Sizes	Peso/Weight
68651	220-230 V / 50-60 Hz	650 W	Ø10 cm	1,132 Kg
68652	220-230 V / 50-60 Hz	1.000 W	Ø12 cm	1,268 Kg

# Colección DOSIFICADORES

Inox  
18/10



Dishwasher

Salado · Salty



Dulce · Sweet



**Ideal para rellenar, verter y decorar**  
Perfect for filling, pouring and decorating

- Ideal para rellenar o decorar platos con salsas y cremas calientes y frías.
- Sistema de palanca para un caudal ajustable; práctico y preciso.
- Sistema antigoteo y antisalpicaduras.
- Mango con diseño ergonómico que permite el manejo con una sola mano.
- Fácil desmontaje para una sencilla limpieza. Apto para el lavavajillas.
- Ref.: 67150: contiene 3 boquillas de distintos diámetros (4, 6 y 8 mm) para que las cremas y salsas fluyan de la forma deseada, en menor o mayor cantidad.

- Idéal pour remplir ou décorer des assiettes avec des sauces chaudes et froides.
- Système de piston pour un débit ajustable ; pratique et précis.
- Système anti-goutte et anti-éclaboussures.
- Manche ergonomique qui permet de le manipuler d'une seule main.
- Facile à démonter pour un nettoyage aisé, et apte pour le lave-vaisselle.
- Ref.: 67150: contient 3 embouts de différents diamètres (4, 6 et 8 mm) pour que les crèmes et les sauces coulent de la façon souhaitée, en plus ou moins grande quantité.

- Er eignet sich ideal zum Anrichten oder Servieren von Saucen und Cremes, gleich ob kalt oder warm.
- Das Hebelsystem ermöglicht einen dosierten, bequemen und genauen Ausschank.
- Antitropf- und Antispritzsystem.
- Ergonomischer Griff für Einhandbedienung.
- Zum Reinigen einfach auseinandernehmbar und spülmaschinengeeignet.
- 3 Aufsätze im Durchmesser von 4, 6 und 8 Millimeter für einen Ausschank von Saucen und Cremes genau nach Bedarf.

- Perfect for filling or decorating dishes with hot or cold sauces and cream.
- Its lever system for controlling the flow is practical and precise.
- Anti-drip and anti-splash system.
- The ergonomic handle means it can be used with just one hand.
- It's easy to disassemble for easy cleaning and it's dishwasher safe.
- Ref.: 67150: includes 3 nozzles with different diameters (4, 6 and 8 mm) so cream or sauce can flow just how you want, at a higher or lower quantity.

- Ideal para decorar platos e dispensar molhos e cremes, quentes ou frios.
- Caudal ajustável mediante sistema de alavanca, prático e preciso.
- Sistema anti-gotejamento e anti-salpicaduras.
- Mango com desenho ergonómico, que permite a manipulação com uma só mão.
- Fácil de desmontar para a sua limpeza. Apto para máquinas de lavar louça.
- Ref.: 67150: inclui 3 boquilhas de diferentes diâmetros (4, 6 e 8 mm), que asseguram um fluxo adequado dos cremes e molhos, em menor ou maior quantidade.



**Incluye soporte y un platillo antigoteo**  
Includes support and a drip dish

**Dosificador**  
Entonnoir à decor  
Dosierer  
Portionner  
Dosificador

Ref	€	Ø (cm)	h (cm)	L	U.Venta
67150	61,60	19	27	2,0	1
R67150B	19,90	4/6/8			1

**Set 3 boquillas**  
Set 3 nozzles



**Ahorre tiempo frente a métodos tradicionales**  
Save time compared to traditional methods



**Si PS**  
Silicone Polystyrene

**Dosificador**  
Entonnoir à decor  
Dosierer  
Portionner  
Dosificador

Ref	€	cm	h (cm)	L	U.Venta
67026	11,80	16x11	18	1,0	1

**Marcas de medición en el contenedor (ml - cup)**  
Measuring marks on the container (ml - cup)



**Sistema antigoteo y salpicaduras**  
Anti drip and splash system

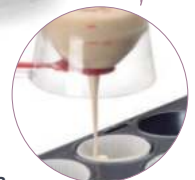

## Diseño premiado en certámenes internacionales

International award-winning flow  
 Good Design 2003 International Industrial  
 Graphic Design Competition The Chicago Athenaeum



Salado · Salty



Dulce · Sweet

**Sistema de gatillo para un caudal ajustable**  
 Trigger system for an adjustable flow



**Base con mucha estabilidad**  
 Base offers great stability

ASA

Acrylic



### Dosificador

Entonnoir à decor  
 Dosierer  
 Portionner  
 Dosificador

Ref.	€	L	U.Venta
67000	88,60	2,00	1

Inox  
 18/10

### Cono

Cône  
 Trichter  
 Cone  
 Cone

Ref.	€	L	U.Venta
R67000	39,30	2,00	1



### Soporte mango

Support  
 Stütze  
 Support  
 Suporte cabo

Ref.	€	U.Venta
R67001	35,40	1



### Base negra

Base noire  
 Ständer, schwarz  
 Black base  
 Base negra

Ref.	€	U.Venta
R67002	13,90	1



### Boquillas

Douille  
 Düse  
 Nozzle  
 Boquilhas

	Ref.	€	Ø (mm)	U.Venta
A	R67003	1,60	1	1
B	R67004	1,80	4	1
C	R67005	1,80	6	1
D	R67006	1,80	8	1

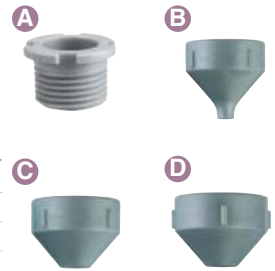

# SIFONES crema



**APTO SOLAMENTE PARA MEZCLAS FRIAS Y TEMPLADAS (<40°C)**  
**À UTILISER UNIQUEMENT POUR LES MÉLANGES FROIDS ET TREMPÉS (<40°C)**  
**ONLY SUITABLE FOR COLD AND TEMPERED MIXTURES (<40°C)**

- Realice en segundos purés, mousses, cremas montadas, espumas, salsas y deliciosos postres, un toque de elegancia en la cocina.
- Ofrece 4 veces más volúmen que el volúmen líquido.
- **NO** debe ser empleado con líquidos calientes. **NUNCA** ponga los sifones al baño maría, puede producirse una explosión con graves consecuencias.

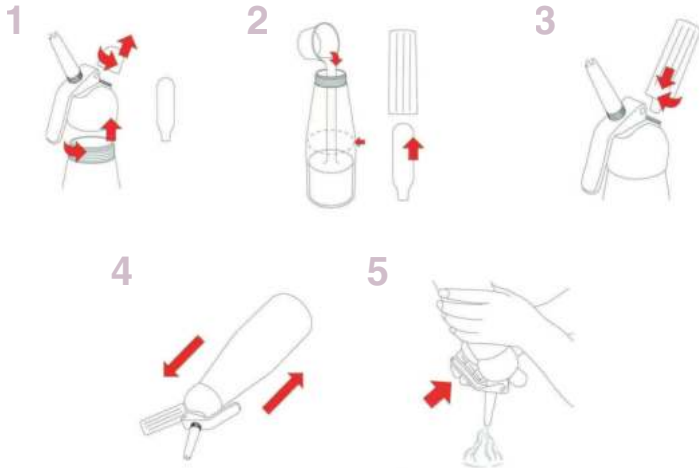

- Réalisez en quelques secondes des purées, des mousses, des crèmes montées, des sauces et de délicieux desserts, une touche d'élégance dans la cuisine.
- Confère 4 fois plus de volume que le volume liquide.
- **NE DOIT PAS** être utilisé avec des liquides chauds. **NE JAMAIS** mettre les siphons au bain marie car une explosion pourrait avoir lieu et provoquer de graves conséquences.

- Pürees, Mousses, Schlagsahne, Schäume, Saucen und köstliche Desserts im Nu zubereiten, ein Hauch von Eleganz in der Küche.
- Vervierfacht das Ausgangsvolumen der Flüssigkeit.
- **NICHT** für Verwendung mit heißen Flüssigkeiten geeignet. Gerät **NIEMALS** ins Wasserbad legen. Dies kann zu einer folgenschweren Explosion führen.

- Make purées, mousses, whipped creams, foams, sauces and delicious desserts in seconds. A touch of elegance in the kitchen.
- Whips content up to 4 times the liquid volume.
- Should **NOT** be used with hot liquids. **NEVER** put siphons in a water bath, as this may cause an explosion with serious consequences.

- Prepare em segundos purés, mousses, cremes batidos, espumas, molhos e deliciosas sobremesas, dando um toque de elegância à sua cozinha.
- Proporciona 4 vezes mais volume do que o volume líquido.
- **NÃO** utilizar com líquidos quentes. **NUNCA** coloque os sífões em banho-maria, para evitar o risco de explosão com consequências graves.



## Cargas sifón N2O

Cartouches N<sub>2</sub>O pour siphon  
 N<sub>2</sub>O Kapsel für Sahnebereiter  
 N<sub>2</sub>O cream charger  
 Botijas de sífão N<sub>2</sub>O



**EXCLUSIVAMENTE PARA USO ALIMENTICIO**  
**EXCLUSIVELY FOR FOOD USE**

Ref	€	Botellas	g	U.Venta
68402	8,30	10	8	1
68403	19,40	24	8	1

**Cabezal: aluminio**  
 Head: aluminium

## Sifón MIX

Siphon à crème  
 Sahnebereite  
 Cream whipper  
 Sífão creme

Ref	€	Ø (cm)	L	U.Venta
68404	117,70	7,8x25	0,50	1
68405	135,20	9,3x32,5	1,00	1



**Botella: inox**  
 Bittle: inox

**Temperatura de uso** · Use temperature  
 min = +5°C / max = +40°C

**Cabezal: plástico PBT**  
 Head: PBT plastic

## Sifón WHITE

Siphon à creme  
 Sahnebereiter  
 Cream whipper  
 Sífão creme

Ref	€	Ø (cm)	L	U.Venta
68502	40,60	9x27	0,25	1
68500	48,10	9x31	0,50	1
68501	53,60	11x36	1,00	1

**Botella: aluminio**  
 Bittle: aluminium



**Cabezal: aluminio**  
 Head: aluminium

## Sifón BLACK

Siphon à creme  
 Sahnebereiter  
 Cream whipper  
 Sífão creme

Ref	€	Ø (cm)	L	U.Venta
68604	50,70	7,8x27,3	0,50	1
68605	55,90	9,3x32,5	1,00	1

**Botella: aluminio**  
 Bittle: aluminium



**Temperatura de uso** · Use temperature  
 min = +5°C / max = +40°C

**Temperatura de uso** · Use temperature  
 min = +5°C / max = +40°C

# Colección MANGAS REPOSTERÍA



- Mangas pasteleras para decorar y personalizar tus postres preferidos.
- Mangas de alta calidad, soportan altas temperaturas, resistentes y reutilizables.
- Aptas para el lavavajillas.

- Poche à douille pour décorer et personnaliser vos desserts préférés.
- Poche de grande qualité, supporte des températures élevées, résistante et réutilisable.
- Compatible avec le lave-vaisselle.

- Spritzbeutel zur Dekoration und individuellen Gestaltung deiner Lieblingsnachtsnacke.
- Spritzbeutel aus qualitativ, beständig auch bei hohen Temperaturen, robust und wiederverwendbar.
- Spülmaschinengeeignet.

- Pastry bag to decorate and customise your favourite desserts.
- Bag of high-quality withstands high temperatures and is durable and reusable.
- Dishwasher safe.

- Manga de pasteiro para decorar e personalizar as tuas sobremesas favoritas.
- Manga de alta qualidade, que suporta altas temperaturas, resistente e reutilizável.
- Apta para a máquina de lavar louça.

## Boquillas · Nozzles

Ø2x3 cm

A



## Boquillas · Nozzles

Ø2,5x4,5 cm

B



Inox	EVA	PP
18/10	Plastic	Polypropylene
Boquilla/Nozzle	Manga/Bag	Tuerca Nut



SI	PP
Silicone	Polypropylene
Manga/Bag	Boquilla Nozzle

## Manga repostería + 4 boquillas

Poche à decorer + 4 Douilles  
Spritzbeutel + 4 Tlg. Tüllensortiment  
Pastry bag + 4 pcs. Nozzles  
Manga de pasteleria + 4 Boquillas

	Ref	€	cm	Ø (cm)	U.Venta
A	68972	7,30	20	20x30	1
B	68973	12,40	30	25x45	1

## Manga repostería + 5 boquillas

Poche à decorer + 5 Douilles  
Spritzbeutel + 5 Tlg. Tüllensortiment  
Pastry bag + 5 pcs. Nozzles  
Manga de pasteleria + 5 Boquillas

	Ref	€	ml	h (cm)	U.Venta
	68971	7,60	800	30	1

## Se adaptan a cualquier tipo de boquilla

Adapts to any kind of nozzle



## LDPE

Low density Polyethilene

Galga 280 = 70 micras (µm)

## Mangas desechables

Poche à decorer jetable  
Einweg Spritzbeutel  
Non-returnable pastry bags  
Mangas descartaveis

	Ref	€	Cantidad	AxB (cm)	U.Venta
	68937	14,60	100	35x21	1
	68939	21,00	100	40x22	1
	68954	31,50	100	55x30	1
	68964	36,90	100	65x32	1

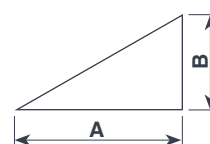

No emplear con alimentos a temperaturas superiores a 60°C

Ne pas utiliser avec des aliments à une température supérieure à 60°C  
Not for use with food at temperatures above 60°C

## PA

Nylon

Boca · Mouth: Ø2,5 cms.

## Manga repostería nylon

Poche à decorer en nylon  
Nylon Spritzbeutel  
Nylon pastry bag  
Manga de pasteleria de nylon

	Ref	€	h (cm)	L	U.Venta
	68930	5,10	30	0,57	6
	68935	6,00	35	1,10	6
	68940	6,60	40	1,45	6
	68945	7,80	45	2,30	6
	68950	8,60	50	2,50	6
	68955	9,50	55	3,40	6
	68960	10,70	60	5,50	6
	68965	11,20	65	6,50	6
	68970	13,50	70	7,50	6

Se adaptan a cualquier tipo de boquilla

Adapts to any kind of nozzle



# Boquillas REPOSTERÍA

Inox  
18/10



Dishwasher



- Fabricadas en acero inoxidable 18/10.
- Excelente resistencia a la corrosión y a los ácidos alimentarios y sales.
- Adaptables a las mangas de repostería.
- Distintas formas para decorar postres.

- Fabriquées en acier inoxydable 18/10.
- Excellente résistance à la corrosion et aux acides et sels alimentaires.
- Adaptables sur les poches à douilles de pâtisserie.
- Différentes formes pour décorer les desserts.

- Aus nicht rostendem 18/10-Stahl hergestellt.
- Sehr korrosionsbeständig und widerstandsfähig gegen Säure aus Lebensmitteln und Salzen.
- Passen auf Spritzbeutel.
- Diverse Formen zur Verzierung von Desserts.

- Made of 18/10 stainless steel.
- Excellent resistance to corrosion and to food acids and salts.
- Can be adapted to piping bags.
- Different shapes for decorating desserts.

- Fabricadas em aço inoxidável 18/10.
- Excelente resistência à corrosão e aos ácidos e sais alimentares.
- Adaptáveis às mangas de pastelaria.
- Diferentes formas para decorar sobremesas.

## Set de 6 boquillas redonda

Ensemble 6 douilles unies  
Lochtüllensatz 6-tlg. rund  
6 plain tube set  
Conjunto de 6 boquillas redondas

Ref	€	Ø (mm)	U.Venta
68908	25,40	8	1
68910	25,40	10	1
68912	25,40	12	1
68915	25,40	15	1



## Set de 6 boquillas estrella

Ensemble 6 douilles cannelées  
Lochtüllensatz 6-tlg. Stern  
6 star tube set  
Conjunto de 6 boquillas estrela

Ref	€	Ø (mm)	U.Venta
68928	25,40	8	1
68900	25,40	10	1
68932	25,40	12	1
68934	25,40	15	1



## Set de 6 boquillas rosa

Ensemble 6 douilles cannelées fermes  
Tüllensatz 6-tlg. Stern, geschlossen  
6 close star tube set  
Conjunto de 6 boquillas rosa

Ref	€	Ø (mm)	U.Venta
68948	25,40	8	1
68980	25,40	10	1
68942	25,40	12	1
68985	25,40	15	1





### Set de 6 boquillas redonda

Ensemble 6 douilles unies  
Lochtüllensatz 6-tlg. rund  
6 plain tube set  
Conjunto de 6 boquillas redonda

Ref	€	Forma (mm)
68996	16,60	Redonda 4/5/6/8/10/12



### Set de 6 boquillas estrella

Ensemble 6 douilles cannelées  
Tüllensatz 6-tlg., Stern  
6 star tube set  
Conjunto de 6 boquillas estrella

Ref	€	Forma (mm)
68997	16,60	Estrella 4/5/6/8/10/12



### Set de 6 boquillas rosa

Ensemble 6 douilles cannelées fermes  
Tüllensatz 6-tlg. Stern, geschlossen  
6 close star tube set  
Conjunto de 6 boquillas rosa

Ref	€	Forma (mm)
68993	16,60	Rosa 4/6/8/10/12/15

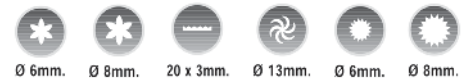

### Set de 6 boq. variadas

Ens. 6 douilles variées  
Tüllensatz 6-tlg.  
6 assorted tube set  
Conjunto de 6 boquillas variadas

Ref	€	Forma (mm)
68998	16,60	Rosa 6/8
		Cinta 20x3
		Hélice 5
		Estrella 6/9/13



### Set de 6 boquillas variadas

Ensemble 6 douilles variées  
Tüllensatz 6-tlg. sortiert  
6 assorted tube set  
Conjunto de 6 boquillas variadas

Ref	€	Forma (mm)
68999	16,60	Rosa 6/8
		Hélice 5
		Estrella 6/9/13

### Set de 2 boquillas relleno

Ensemble 2 douilles petit chou  
Einfülltüllensatz 2-tlg.  
2 Bismark tube set  
Conjunto de 2 boquillas relleno

Ref	€	Forma (mm)
68992	10,90	Relleno 4/8

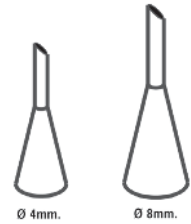

### Juego 6 boquillas rusas

Ensemble 6 douilles russes  
6-Tlg Russian Tüllensatz  
Set 6 Russian decorating nozzles  
Conjunto 6 boquillas russo

	Ref	€	Ø (cm)	h (cm)	Unidades	U.Venta
A	68892	8,40	3,5	4,5	6	6
B	68893	14,50	3,0	6,2	6	1

A



B



Inox

### Juego de boquillas decoración

Deuilles assorties décoration  
Dekorations-Tüllensatz  
Decorating nozzles  
Jogo de boquillas decoração

Ref	€	Piezas	U.Venta
68991	16,50	26	1



ASA

Acrylic



### Set 24 pcs. boquillas

24 pcs. douilles assorties  
24 tlg. Tüllensortiment  
24 pcs. nozzles set  
Conjunto de 24 boquillas

Ref	€	Piezas	U.Venta
68994	15,20	24	1





# Botellas BIBERÓN · Pistolas REPOSTERÍA



Polyethylene (PE)

Polyethylene (PELD)  
Polyethylene Low Density



## Botella biberón c/boquilla triple

Bouteille biberon avec douille triple  
Dosierflasche mit Dreifachdüse  
Squeeze bottle with triple nozzle  
Garrafa com boquilha triplo

Ref	€	Ø (cm)	L	U.Venta
61974	4,00	7x20	0,472	6
61977	4,30	7x26	0,708	6

Sist. de boca ancha que facilita el llenado  
Wide mouth system for easy filling

PE

Polyethylene

## Botella biberón PUSH

Bouteille biberon  
Dosierflasche  
Squeeze bottle  
Garrafa



Ref	€	Ø (cm)	L	U.Venta
61978	4,50	6x20	0,50	1
61979	4,60	7x20	0,60	1
61980	4,80	7x26	0,70	1

SI

Silicone

## Biberón decoración

Biberon à decorer  
Dekorierflasche  
Decorating pen  
Garrafa decoração



Ref	€	Ø (cm)	L	U.Venta
64457	9,50	5,5x16	0,14	1

· Ideales para salsas, cremas, aceites, aliños, vinagretas y todo tipo de condimentos líquidos. Dibuja, adorna y personaliza con estilo tus platos.

· Idéal pour les sauces, les crèmes, les huiles, les assaisonnements, les vinaigrettes et tout type de condiments liquides. Il dessine, décore et personnalise les plats.

· Ideal für Soßen, Cremes, Öle, Dressings, Vinaigretten und alle möglichen flüssigen Gewürze. Verschönern und verzieren Sie Ihre Gerichte und geben Sie ihnen Ihren persönlichen Touch.

· Ideal for sauces, creams, oils, dressings, vinaigrettes and all kinds of liquid condiments. Draw, decorate and personalize your dishes with style.

· Ideais para molhos, cremes, óleos e azeites, temperos, vinagretas e todo o tipo de condimentos líquidos. Desenha, decora e personaliza com estilo.



Inox  
18/10

## Pistola decoración repostería

Pistolet Décoration Pâtisserie  
Pistole für Tüllensätze  
Pastry Decoration Gun  
Pistola Decoração Pastelaria

Ref	€	L	U.Venta
61407	32,60	0,25	1



Inox  
18/10

## Juego pistola repostería

Pistolet pour pâtisserie  
Pistole für Tüllensätze  
Cookie press cum icing set  
Jogo de pistola pastelaria

Ref	€	L	U.Venta
68989	48,10	0,25	1

# Baños María CHOCOLATE

Inox  
18/10



new

Capacidad chocolate: 1,0 L  
Chocolatecapacity: 1,0 L



Abertura lateral para llenar de agua (1,0 L)

Side opening to introduce water (1,0 L)



- Cazo de doble pared para cocinar al baño maría.
  - Fabricado en acero inoxidable 18/10 de máxima calidad.
  - Doble pared: evita que el agua entre en contacto con el alimento.
  - Abertura en el lateral para un llenado práctico y cómodo.
  - Ideal para derretir chocolate, caramelo, emulsionar salsas, fundir mantequilla, etc.
  - Mango de baquelita termorresistente.
  - Apto para todos los fuegos (incluido la inducción).
  - Fácil de usar y limpiar. Se puede lavar en lavavajillas.
- Double-walled saucepan for bain-marie cooking.
  - Made of top quality 18/10 stainless steel.
  - Double wall: prevents the water from coming into contact with the food.
  - Convenient, easy-to-fill opening on the side.
  - Ideal for melting chocolate, caramel, for blending sauces, melting butter, etc.
  - Heat-resistant Bakelite handle.
  - Suitable for all sources of heat, including induction.
  - Easy to use and clean. Dishwasher safe.

## Cazo baño maría

Casserole bain marie  
Stielkasserolle für Wasserbad  
Bain-marie saucepan  
Çaçarol para banho-maria

Ref	€	Ø (cm)	h (cm)	L	U.Venta
62600	29,90	16	10,0	1,00	1

Permite fundir chocolate y mantenerlo caliente  
It allows you to melt chocolate and keep it hot

Cazo desmontable  
de acero inoxidable 18/10 de gran calidad  
High quality 18/10 st. steel collapsible pan



- Preparar fácilmente coberturas para sus postres.
  - Puede añadirle especias (canela, jengibre en polvo, pimientas, vainilla) para un chocolate más intenso.
- Easily prepare toppings for your desserts.
  - You can add spices (cinnamon, ginger powder, peppers, vanilla) for a more intense chocolate.

## Baño maría chocolate

Bain marie de chocolat  
Bain Marie topf für Schokolade  
Chocolate bain marie  
Banho-maria chocolate

Ref	€	W	U.Venta
69317	41,70	50	1

new



- Perfecta para elaborar coberturas de alta calidad y mantenerlas a la temperatura deseada durante horas.
  - Ideal para la obtención de un glaseado brillante para pasteles, tartas, cake pops, muffins, etc.
  - Contenedor GN1/6 (1,50L) y tapa extraíble de acero inoxidable 18/10 para garantizar una rápida y efectiva limpieza (aptos para el lavavajillas).
  - Regulación de temperatura por termostato de 0°C a 60°C.
  - Calentamiento 3D; el calor se distribuye de manera uniforme por toda la superficie del recipiente.
  - Luz indicadora, se enciende tan pronto como se alcanza la temperatura deseada.
  - Compatible con cubetas GN1/6 de Lacor.
- Perfect for making high quality toppings and keeping them at the desired temperature for hours
  - Ideal for getting shiny glazing on pies, cakes, cake pops, muffins, and more
  - It has a GN1/6 (1.5 L) container and removable 18/10 stainless steel lid to make cleaning fast and effective. Dishwasher safe.
  - The temperature can be regulated with a thermostat from 0°C to 60°C.
  - 3D Heating: Heat is distributed evenly over the entire surface of the container.
  - The indicator lights up as soon as the desired temperature is reached.
  - It's compatible with GN1/6 pans from Lacor.

## Baño maría chocolate

Bain marie de chocolat  
Bain Marie topf für Schokolade  
Chocolate bain marie  
Banho-maria chocolate

Ref	€	W	U.Venta
69617	75,50	80	1

Ref	Tensión/Voltage	Potencia/Power	Temperatura/Temp.	Capacidad/Capacity	Dimensiones/Sizes	Peso/Weight
69317	230-240 V / 50-60 Hz	50 W	40-50°C	1,0 L (max)	29x22x12 cm	0,875 Kg
69617	230-240 V / 50-60 Hz	80 W	0-60°C	1,5 L (max)	22,5x26x14,5 cm	1,250Kg

# Utensilios REPOSTERÍA

Inox  
18/10



Dishwasher

Acero cromado  
Chrome Steel



## Rejilla para repostería

Grille pâtisserie  
Kuchengitter rund  
Pastry rack  
Grelha para pasteleria

Ref	€	Ø (cm)	U.Venta
66916	6,20	28	6
66926	6,30	32	6
66917	8,30	36	6



Acero cromado  
Chrome Steel

## Rejilla rectangular para repostería

Grille rectangulaire pour pâtisserie  
Kuchengitter rechteckig  
Rectangular pastry rack  
Grelha rectangular para pasteleria

Ref	€	cm	U.Venta
66927	8,50	43x30	6

- Rejillas de alambre resistentes para dejar reposar los postres recién sacados del horno o cubrir de chocolate o azúcar glas.
- Fabricadas en acero cromado para una larga duración.
- Permite enfriar homogéneamente todas las partes del postre incluida la parte inferior.
- Protegen las superficies de la cocina de quemaduras.
- No se recomienda su uso en el lavavajillas.

- Grilles de refroidissement en métal pour laisser reposer les desserts fraîchement sortis du four ou les napper de chocolat ou de sucre glace.
- Fabriquée en acier chromé pour une grande durabilité.
- Permet de refroidir de façon homogène toutes les parties du dessert, y compris la partie inférieure.
- Protège les surfaces de la cuisine des brûlures.
- Lavage au lave-vaisselle déconseillé

- Robustes Kuchenrost zum Ablegen der ofenfrischen Backwaren oder zum Auftragen einer.
- Schokoladenglasur oder von Puderzucker.
- Aus widerstandsfähigem, verchromtem Stahl.
- Gebäck kühlt mithilfe dieses Gitters gleichmäßig ab, auch auf der Unterseite.
- Schützt die Oberfläche der Küchenplatte vor Verbrennungen.
- Nicht im Geschirrspüler reinigen.

- Resistant wire rack for cooling freshly baked desserts or covering them in chocolate or sugar glass.
- Made of chrome steel for a long life.
- Allows all parts of the dessert to cool evenly, including the bottom.
- Protects kitchen surfaces from burns.
- Dishwasher not recommended.

- Grelhas de arame resistente para deixar repousar as sobremesas que se acabam de retirar do forno ou para cobrir com chocolate ou açúcar glace.
- Fabricadas em aço cromado para uma longa duração.
- Permite arrefecer de maneira homogénea todas as partes dos bolos, incluindo a parte de baixo.
- Protege de queimaduras as superfícies da cozinha.
- Não se recomenda máquina de lavar louça.

MF

70°C  
-20°C



Melamine

Stackable

Direct heat

Microwave

Oven

Dishwasher

BPA free

## Portatartas

Gueridon pâtisier  
Kuchenplatte  
Cake stand  
Porta-tartes



Ref	€	Ø (cm)	U.Venta
67030	173,40	30	1

## Portatartas

Guéridon pâtisserie  
Kuchenplatte  
Cake stand  
Porta-tartes



Ref	€	cm	U.Venta
63586	32,50	33x9	4

Situar · Marcar · Repartir  
Place · Mark · Partitioning

Porción de tarta  
Slice of cake

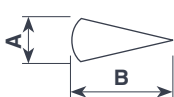

PP

Polypropylene

## Marcador de tartas

Marqueur à gateaux  
Tortenteiler  
Cake marker  
Marcador de bolos

Ref	€	Ø (cm)	Porciones	AxB (cm)	U.Venta
68511	8,80	27	10 / 12	8,5x13,5 / 7,5x13,5	1
68513	8,80	27	14 / 16	6x13,5 / 5,5x13,5	1



Con anillas  
With rings

## Pinza repostería

Pince à gateau  
Gebäck-Tortenzange  
Cake tong  
Pinça pastelaria

Ref	€	L (cm)	U.Venta
A 62317	11,70	20	1
B 68008	5,90	16	6

# Colección RACIONADORES DE HELADO

Inox  
18/10



Dishwasher



- Utensilio de repostería perfecto para formar bolas de helado sin esfuerzo.
- Mecanismo de estilo guillotina para extraer y servir fácilmente bolas de helado.
- Gran resistencia y durabilidad.
- Fácil de usar y limpiar. Apto para lavavajillas.

- Ustensile de pâtisserie parfait pour faire des boules de glace sans efforts.
- Mécanisme de style guillotine pour extraire et servir facilement les boules de glace.
- Grande résistance et durabilité.
- Facile à utiliser et à nettoyer. Apte pour le lave-vaisselle.

- Formt mühelos perfekte Eiskugeln.
- Schneidemechanismus zum einfachen Lösen und Anrichten von Eiskugeln.
- Sehr widerstandsfähigkeit und haltbar.
- Einfach zu benutzen und reinigen. Spülmaschinenfest.

- A perfect confectionery utensil for making balls of ice cream effortlessly.
- Guillotine style mechanism for easily scooping and serving balls of ice cream.
- Very strong and durable.
- Easy to use and clean. Dishwasher safe.

- Utensílio de pastelaria, ideal para formar bolas de gelado sem esforço.
- Mecanismo tipo guilhotina para extrair e servir facilmente bolas de gelado.
- Grande resistência e durabilidade.
- Fácil de usar e de limpar. Apto para máquinas de lavar louça.

## Copa baja

Coupe à glace basse  
Eiskelch  
Ice cream cup  
Taça de gelado



Ref	€	Bolas/L	cm	U.Venta
67002	4,80	5,5	Ø9x12	12

## Racionador profesional

Cuillère à glace professionnel  
Eisportionierer, Profi  
Professional ice cream scoop  
Racionador profesional



Ref	€	Bolas/L	Ø (mm)	U.Venta
67038	33,50	50	39	10
67043	33,50	40	44	10
67045	34,40	36	46	10
67047	34,40	30	48	10
67049	34,40	24	50	10
67052	35,60	20	53	10
67055	35,60	16	56	10
67058	35,60	13	59	10
67062	35,60	12	63	10
67065	35,60	10	66	10
67069	35,70	8	70	10
67074	35,70	7	75	10
67084	35,70	5	85	10

## Racionador helado

Cuillère à glace  
Eisportionierer  
Ice cream scoop  
Racionador de gelado



Ref	€	Bolas/L	Ø (mm)	U.Venta
67039	17,80	50	39	10
67044	17,80	40	44	10
67046	17,80	36	46	10
67048	17,80	30	48	10
67050	17,80	24	50	10
67053	18,10	20	53	10
67056	18,80	16	56	10
67059	18,80	13	59	10
67063	18,80	12	63	10
67066	19,20	10	66	10
67070	19,20	8	70	10



### Racionador profesional oval

Cuillère à glace luxe ovale  
Eisportionierer, Profi  
Ice cream scoop luxe oval  
Racionador oval profesional

Ref	€	Bolas/L	mm	U.Venta
67153	35,40	40	53x41	10
67158	35,40	30	58x48	10
67163	35,40	20	63x48	10



**PA** Fibra de vidrio  
Nylon Fibreglass **Inox**



### Racionador helado WHITE

Cuillère à glace  
Eisportionierer  
Ice cream scoop  
Racionador de gelado

Ref	€	Bolas/L	Ø (mm)	U.Venta
67040	9,40	24	50	12



### Racionador de helado PRO

Cuillère à glace  
Eisportionierer  
Ice cream scoop  
Racionador de gelado

	Ref	€	L (cm)	Color	U.Venta
<b>A</b>	67091	9,20	26,5	<b>Azul</b> · Blue	1
<b>B</b>	67092	9,20	26,5	<b>Naranja</b> · Orange	1
<b>C</b>	67093	9,20	26,5	<b>Rojo</b> · Red	1
<b>D</b>	67094	9,20	26,5	<b>Verde</b> · Green	1
<b>E</b>	67095	9,20	26,5	<b>Transparente</b> · Transparent	1

### AL

Aluminium



### Racionador helado aluminio

Cuillère à glace aluminium  
Eisportionierer, Aluminium  
Aluminium ice cream scoop  
Racionador de gelado aluminio

Ref	€	Bolas/L	Ø (mm)	ml	L (cm)	U.Venta
67090	9,60	50	50	12	18	1

- Utensilio de repostería perfecto para formar bolas de helado sin esfuerzo.
- Diseño original, ergonómico y muy ligero.
- Fabricado en nylon y fibra de vidrio. Libre de BPA.
- Mecanismo de estilo guillotina para extraer y servir fácilmente bolas de helado.
- Cuchara de 5 cm de diámetro, 24 bolas/L de capacidad.
- Gran resistencia y durabilidad.
- Fácil de usar y limpiar. Apto para lavavajillas.

- Ustensile de pâtisserie parfait pour faire des boules de glace sans efforts.
- Conception originale, ergonomique et très légère.
- Fabriqué en nylon et fibre de verre. Sans BPA.
- Mécanisme de style guillotine pour extraire et servir facilement les boules de glace.
- Cuillère de 5 cm de diamètre, capacité de 24 boules/L.
- Grande résistance et durabilité.
- Facile à utiliser et à nettoyer. Apte pour le lave-vaisselle.

- A perfect confectionery utensil for making balls of ice cream effortlessly.
- The design is original, ergonomic and very light weight.
- Made of Nylon and fiberglass BPA free.
- Guillotine style mechanism for easily scooping and serving balls of ice cream.
- 5 cm diameter spoon, 24 balls/L capacity.
- Very strong and durable.
- Easy to use and clean. Dishwasher safe.

- Cucharas para servir helado. Fabricadas en acero inoxidable 18/10 de máxima calidad.
- Mango ergonómico en plástico SAN, diseño antideslizante.
- Disponible en diferentes colores; azul, naranja, rojo, verde y transparente.

- Cuillères pour servir la glace. Fabriquées en acier inoxydable 18/10 de grande qualité.
- Manche ergonomique en plastique SAN, conception antidérapante.
- Disponible en différentes couleurs : bleu, orange, rouge, vert et transparente.

- Servierlöffel für Eis. Aus nicht rostendem Edelstahl 18/10.
- Ergonomischer Griff aus SAN-Kunststoff, rutschfeste Form.
- Erhältlich in Blau, Orange, Rot, Grün und Transparent.

- Spoons for serving ice cream. Made of 18/10 top quality stainless steel.
- Ergonomic SAN plastic handle, non-slip design.
- Available in different colours: Blue, orange, red, green and transparent.

- Colheres para servir gelado. Fabricadas em aço inoxidável 18/10, da máx. qualidade.
- Mango ergonómico antideslizante de plástico SAN.
- Disponível em diferentes cores; azul, laranja, vermelho, verde e transparente.



# Moldes • Aros

Moulds • Cake rings

# Colección moldes **BLACK**



## Antiadherentes, flexibles, duraderos, higiénicos y fáciles de limpiar

Non-stick, flexible, long-lasting, hygienic and easy to clean

- Amplia gama de moldes de silicona para procesos de horneado y congelación.
- Antiadherentes, flexibles, duraderos, higiénicos y fáciles de limpiar.
- Soportan fuertes cambios de temperatura.
- No transmiten sabores ni olores.
- Permiten desmoldar fácil y perfectamente los alimentos.

- Large gamme de moules en silicone pour enfourner et congeler.
- Antiadhésifs, flexibles, durables, hygiéniques et faciles à nettoyer.
- Supportent de fortes variations de température.
- Ne transmettent ni goûts ni odeurs.
- Permettent de démouler facilement et parfaitement les aliments.

- Großes Angebot an Back- und Gefrierformen aus Silikon.
- Mit Antihafwirkung, flexibel, haltbar, hygienisch und leicht zu reinigen.
- Widerstandsfähig gegen abrupte Temperaturwechsel.
- Übertragen keinen Geschmack/Geruch.
- Einfaches und perfektes Ausformen möglich.

- Wide range of silicone moulds for baking and freezing processes.
- Non-stick, flexible, long-lasting, hygienic and easy to clean.
- They can withstand drastic temperature changes.
- They do not transmit flavours or odours.
- Food can be de-moulded quickly and perfectly with them.

- Ampla gama de moldes de silicone para levar ao forno e para congelar.
- Antiaderentes, flexíveis, duráveis, higiénicos e fáceis de limpar.
- Suportam grandes mudanças de temperatura.
- Não transmitem sabores nem cheiros.
- Permitem desenformar fácil e perfeitamente os alimentos.



### Briochette 24 cavidades

Briochette 24 cavités  
 Briocheform für 24 Madaleine  
 Briochette 24 moulds  
 Briochette 24 cavidades

Ref	€	Ø (mm)	h (mm)	ml
66760	100,20	79	35	84



### Semiesférica 28 cavidades

Hemispher 28 cavités  
 Halbkugelform für 28 Madaleine  
 Half-spheres 28 moulds  
 Semi-esférica 28 cavidades

Ref	€	Ø (mm)	h (mm)	ml
66761	100,20	70	35	90

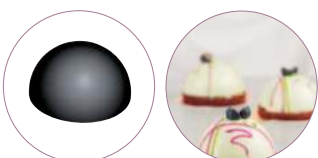

### Semiesférica 60 cavidades

Hemispher 60 cavités  
 Halbkugelform für 60 Madaleine  
 Half-spheres 60 moulds  
 Semi-esférica 60 cavidades

Ref	€	Ø (mm)	h (mm)	ml
66747	98,30	42	20	10

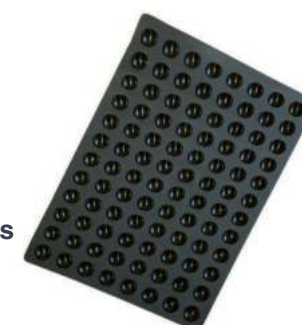

### Mini semiesférica 96 cavidades

Mini Hemispher 96 cavités  
 Mini Halbkugelform für 96 Madaleine  
 Mini Half-spheres 96 moulds  
 Mini semi-esférica 96 cavidades

Ref	€	Ø (mm)	h (mm)	ml
66762	100,20	35	17,5	11



### Florentina 15 cavidades

Florentine 15 cavités  
Florentinerform für 15 Madaleine  
Florentina 15 moulds  
Florentina 15 cavidades

Ref	€	Ø (mm)	h (mm)	ml
66748	98,30	100	20	100



### Florentina 40 cavidades

Florentine 40 cavités  
Florentinerform für 40 Madaleine  
Florentina 40 moulds  
Florentina 40 cavidades

Ref	€	Ø (mm)	h (mm)	ml
66764	100,20	60	11	25



### Madalena 44 cavidades

Madeleine 44 cavités  
Madeleinform für 44 Madaleine  
Madeleine 44 moulds  
Madalena 44 cavidades

Ref	€	mm	h (mm)	ml
66763	100,20	77x44,5	18	32



### Mini muffin 70 cavidades

Mini muffin 70 cavités  
Mini Muffinform klein für 70 Madaleine  
Mini muffin 70 moulds  
Mini muffin 70 cavidades

Ref	€	Ø (mm)	h (mm)	ml
66765	100,20	45	30	40



### Muffin 24 cavidades

Muffin 24 cavités  
Muffinform für 24 Madaleine  
Muffin 24 moulds  
Muffin 24 cavidades

Ref	€	Ø (mm)	h (mm)	ml
66766	100,20	69	39	122



### Tartaleta 60 cavidades

Tartalette 60 cavités  
Torteleitform für 60 Madaleine  
Tartlet 60 moulds  
Tarte 60 cavidades

Ref	€	Ø (mm)	h (mm)	ml
66767	100,20	44	10	10



### Piramide 35 cavidades

Pyramide 35 cavités  
Pyramidenform für 35 Madaleine  
Pyramid 35 moulds  
Pirâmide 35 cavidades

Ref	€	mm	h (mm)	ml
66768	100,20	65x65	35	61

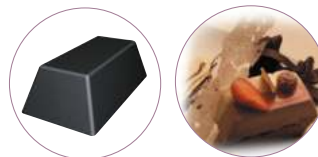

### Mini cake 30 cavidades

Mini cake 30 cavités  
Mini Kuchenform für 30 Madaleine  
Mini cake 30 moulds  
Mini cake 30 cavidades

Ref	€	mm	h (mm)	ml
66769	100,20	99x49	30	110





# Colección moldes **PASTRYFLEX**

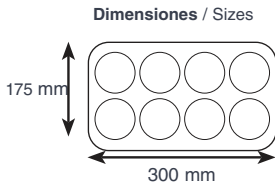
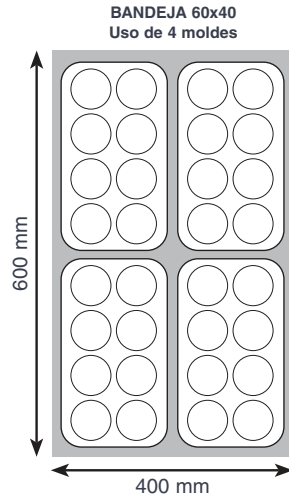
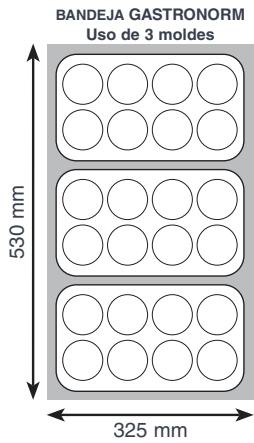

## Cilindro 8 cavidades

Cylindre 8 cavités  
Zylinderform für 8 Madeleine  
Cylindre 8 moulds  
Cilindro 8 cavidades

Ref	€	Ø (mm)	h (mm)	ml	U.Venta
66807	15,60	60	35	90	1



## Madalena pequeña 15 cavid.

Petite madeleine 15 cavités  
Madeleineform, Klein, für 15 Madeleine  
Small madeleine 15 moulds  
Madalena pequena 15 cavidades

Ref	€	mm	h (mm)	ml	U.Venta
66816	15,60	42x30	11,5	10	1

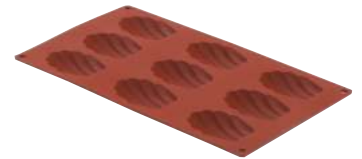

## Madalena 9 cavidades

Madeleine 9 cavités  
Madeleineform 9 Madeleine  
Madeleine 9 moulds  
Madalena 9 cavidades

Ref	€	mm	h (mm)	ml	U.Venta
66817	15,60	78x45	17	30	1



## Briochette 6 cavidades

Briochette 6 cavités  
Briocheform 6 Madeleine  
Briochette 6 moulds  
Briochette 6 cavidades

Ref	€	Ø (mm)	h (mm)	ml	U.Venta
66819	15,60	103	20	110	1



## Briochette 6 cavidades

Briochette 6 cavités  
Briocheform 6 Madeleine  
Briochette 6 moulds  
Briochette 6 cavidades

Ref	€	Ø (mm)	h (mm)	ml	U.Venta
66820	15,60	79	30	110	1



## Semiesférica 24 cavidades

Hemispher 24 cavités  
Halbkugelform 24 Madeleine  
Half-spheres 24 moulds  
Semi-esférica 24 cavidades

Ref	€	Ø (mm)	h (mm)	ml	U.Venta
66800	15,60	30	17	10	1



## Semiesférica 15 cavidades

Hemispher 15 cavités  
Halbkugelform 15 Madeleine  
Half-spheres 15 moulds  
Semi-esférica 15 cavidades

Ref	€	Ø (mm)	h (mm)	ml	U.Venta
66801	15,60	40	20	20	1

### Semiesférica 6 cavidades

Hemisphere 6 cavités  
Halbkugelform 6 Madeleine  
Half-spheres 6 moulds  
Semi-esférica 6 cavidades



Ref	€	Ø (mm)	h (mm)	ml	U.Venta
66802	15,60	70	35	80	1

### Pirámide 6 cavidades

Pyramide 6 cavités  
Pyramideform 6 Madeleine  
Pyramid 6 moulds  
Pirâmide 6 cavidades



Ref	€	mm	h (mm)	ml	U.Venta
66822	15,60	71x71	41	90	1

### Muffin 6 cavidades

Muffin 6 cavités  
Muffinform 6 Madeleine  
Muffin 6 moulds  
Muffin 6 cavidades



Ref	€	Ø (mm)	h (mm)	ml	U.Venta
66805	15,60	70	40	100	1

### Mini muffin 11 cavidades

Mini muffin 11 cavités  
Muffinform klein für 11 Madeleine  
Mini muffin 11 moulds  
Mini muffin 11 cavidades



Ref	€	Ø (mm)	h (mm)	ml	U.Venta
66804	15,60	50	28	50	1

### Corazón 8 cavidades

Coeur 8 cavités  
Herzform 8 Madeleine  
Heart 8 moulds  
Coração 8 cavidades



Ref	€	mm	h (mm)	ml	U.Venta
66824	15,60	65x60	35	90	1

### Rectángulo pequeño 20 cavidades

Petit rectangle 20 cavités  
Form rechteckig für 20 Madeleine  
Petit-four 20 moulds  
Rectángulo pequeno 20 cavidades



Ref	€	mm	h (mm)	ml	U.Venta
66825	15,60	49x26	11	20	1

### Cake 12 cavidades

Cake 12 cavités  
Kuchenform 12 Madeleine  
Cake 12 moulds  
Cake 12 cavidades



Ref	€	mm	h (mm)	ml	U.Venta
66826	15,60	80x30	30	70	1

### Mini savarin 18 cavidades

Mini savarin 18 cavités  
Savarinform 18 Madeleine  
Mini savarin 18 moulds  
Mini savarin 18 cavidades

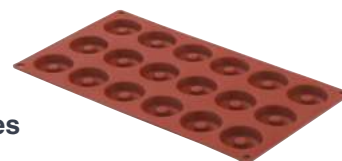

Ref	€	Ø (mm)	h (mm)	ml	U.Venta
66808	15,60	41	12	18	1

### Molde de flan 6 cav.

Moule à flan 6 cavités  
Madeleine Backform für 6 Madeleine  
Creme caramel 6 moulds  
Molde de flan 6 cavidades



Ref	€	cm	h (cm)	L	U.Venta
66736	21,80	29x19	5	0,16	1

### Molde cake

Moule à cake  
Kuchenform  
Cake mould  
Molde cake



Ref	€	cm	h (cm)	L	U.Venta
66733	21,60	24x10	6,5	1,50	1
66742	23,70	26x10	7,0	1,55	1

Con anillo de refuerzo  
With a reinforced ring

**Con anilla de refuerzo**  
With a reinforced ring



**Molde savarín bajo**

Moule Savarin bas  
Savarinform, klein  
Low Savarin mould  
Molde pudin baixo

Ref	€	Ø (cm)	h (mm)	L	U.Venta
66734	21,80	24	6,0	1,25	1



**Con anilla de refuerzo**  
With a reinforced ring

**Con anilla de refuerzo**  
With a reinforced ring



**Molde savarín alto**

Moule Savarin haut  
Savarinform, gross  
High Savarin mould  
Molde pudin alto

Ref	€	Ø (cm)	h (mm)	L	U.Venta
66735	23,80	22	11,0	2,20	1

**Molde redondo**

Moule à manque  
Tortenform  
Round cake mould  
Molde redondo



Ref	€	Ø (cm)	h (mm)	L	U.Venta
66737	21,20	24	4,5	1,70	1
66738	21,80	26	4,5	2,20	1

Colección moldes **PLATINIUM**

*new*

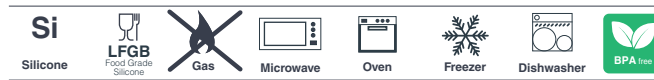

- Fabricados 100% en silicona platino de máxima calidad. Libres de BPA.
- Ligeros, flexibles y antiadherentes; muy fáciles de desmoldar.
- Apilables.
- Aptos para horno, microondas y congelador.
- Se limpian muy fácil y son aptos para el lavavajillas.

- Fabriqués en 100% silicone platine de la plus haute qualité. Sans BPA.
- Légers, flexible et antiadhésifs ; très faciles à démouler.
- Empilables.
- Peuvent aller au four, au micro-ondes et au congélateur.
- Facile à nettoyer et lavable au lave-vaisselle.

- Made of 100% top quality platinum-cured silicone.
- Lightweight, flexible and non-stick. Very easy to de-mould.
- Stapelbar.
- Oven, microwave and freezer safe.
- It's very easy to clean and dishwasher safe.



**Set de 2 moldes donuts**

Ensemble de 2 moules à donuts  
Set mit 2 Donut-Formen  
Set of 2 doughnut moulds  
Conjunto de 2 moldes para donuts



Ref	€	Ø (cm)	h (mm)	L	U.Venta
68770	16,90	7,0	2	0,07	1

### Molde donuts

Moules à donuts  
Donut-Formen Zweier  
Doughnut moulds  
Molde para donuts



Ref	€	Ø (cm)	h (mm)	L	U.Venta
68760	8,50	7,0	2	0,07	1

### Molde donuts rizado

Moules à donuts frisé  
Donut-Formen  
Doughnut moulds curly  
Molde para donuts frizado



Ref	€	Ø (cm)	h (mm)	L	U.Venta
68761	10,80	6,5	2	0,08	1

### Molde muffin

Moules à muffin  
Muffinform  
Muffin mould  
Molde muffin



Ref	€	Ø (cm)	h (mm)	L	U.Venta
68763	11,30	6,5	3	0,08	1

### Molde flan rizado

Moules à flan  
Becherförmchen  
Pudding mould  
Molde para flan



Ref	€	Ø (cm)	h (mm)	L	U.Venta
68762	11,30	7,0	4	0,10	1

### Molde cake

Moules à cake  
Kuchenform  
Cake mould  
Molde cake



Ref	€	cm	h (mm)	L	U.Venta
68764	10,10	23,5x10	6	1,15	1

### Molde redondo

Moules à manque  
Tortenform  
Round mould  
Molde redondo



Ref	€	Ø (cm)	h (mm)	L	U.Venta
68765	13,00	28	3	1,80	1

### Molde redondo rizado

Moules à manque frisé  
Tortenform  
Curly round mould  
Molde redondo frizado



Ref	€	Ø (cm)	h (mm)	L	U.Venta
68766	12,80	30	4,5	1,20	1

### Molde savarín

Moules à savarin  
Savarinform  
Savarin mould  
Molde savarin



Ref	€	Ø (cm)	h (mm)	L	U.Venta
68767	19,80	22	11	2,30	1

**Apto para las freidoras de aire (69509/69511)**

Suitable for air fryers (69509/69511)

### Molde savarín bajo

Moules à savarin basse  
Savarinform  
Low savarinmould  
Molde savarin baixo



Ref	€	Ø (cm)	h (mm)	L	U.Venta
68768	16,20	25	7,0	1,50	1

### Molde savarín mini

Moules mini savarin  
Savarinform Mini  
Mini savarinmould  
Molde mini savarin



Ref	€	Ø (cm)	h (mm)	L	U.Venta
68769	8,60	15	6,5	0W,50	1

# Colección **MOLDES DESMONTABLES SILICONA**



- Molde 100% silicona alimentaria antiadherente a prueba de goteo.
- Base de cristal con recubrimiento antiadherente; perfecto para presentarlo en la mesa sobre la misma base.
- Se desmolda fácilmente.
- Sistema de cierre seguro antiderrame; ideal para pasteles y tartas delicadas.
- Apto para el horno.
- Fácil limpieza. Se puede lavar en el lavavajillas.

- Moule 100% silicone alimentaire antiadhésif anti-gouttes.
- Base en verre avec revêtement antiadhésif ; parfaite pour présenter les mets sur la table.
- Démoulage facile.
- Système de fermeture sûr anti-coulores ; idéal pour les gâteaux et tartes délicates.
- Apte pour le four.
- Nettoyage facile. Peut se laver au lave-vaisselle.

- Backform aus 100 % lebensmittelechtem Silikon, mit Antihafwirkung und Auslaufschutz.
- Glasboden mit Antihafbeschichtung, ideal als Tischzeug.
- Leichtes Ausformen.
- Dichter Verschluss eignet sich ideal für Kuchen und feine Torten.
- Backofenfest.
- Einfache Reinigung. Spülmaschinengeeignet.

- Non-stick leak proof mould made of 100% food grade silicone.
- Cut resistant glass base coating; perfect for serving at the table on the same base.
- Easily removed from the mould.
- Secure spill-proof locking system; ideal for delicate cakes and tarts.
- Oven safe.
- Easy to clean. Dishwasher safe.

- Forma 100% de silicone alimentar, antiaderente e à prova de gotejamento.
- Base de cristal com revestimento antiaderente. Ideal para servir à mesa sobre a mesma base.
- Fácil de desenformar.
- Sistema de fecho seguro anti-derramamento. Ideal para bolos e tartes delicadas.
- Apta levar ao forno.
- Fácil de limpar, apta para máquinas de lavar louça.



## Molde desmontable redondo

Moule demontable à manque  
Backform rund, zerlegbar  
Round dismantable mould  
Molde desmontável redondo

Ref	€	Ø (cm)	h (cm)	L	U.Venta	
66775	22,50	25	7,5	2,0	1	Acabado brillo Gloss finish
* 66778	17,50	20	7,5	1,6	1	Acabado mate Matt finish

\* Apto para la freidora de aire (69511)  
Suitable for air fryer (69511)



**Cerrar molde con pinza de sujeción**  
Close mould with fastening clamp



**Verter masa en silicona a prueba de goteo**  
Pour dough in leak-proof silicone



**Se desmolda con suma facilidad, flexible**  
Easily removed from mould, flexible



**Base de cristal antiadherente**  
Glass base non stick

## Molde desmontable cake

Moule demontable à cake  
Kuchenform, zerlegbar  
Cake dismantable mould  
Molde desmontável cake



Ref	€	cm	h (cm)	L	U.Venta	
66776	21,80	29x13	7,0	1,5	1	Acabado brillo Gloss finish

## Molde desmontable cuadrado

Moule demontable à carré  
Backform viereckig, zerlegbar  
Square dismantable mould  
Molde desmontável quadrado



Ref	€	cm	h (cm)	L	U.Venta	
66777	25,40	25x25	7,5	2,5	1	Acabado brillo Gloss finish
66779	21,00	18x18	7,0	2,3	1	Acabado mate Matt finish

# Moldes REPOSTERÍA



**Apto para todas las freidoras de aire**  
Suitable for all air fryers



## Set 12 moldes muffin silicona

Set 12 moules muffin en silicone  
Set 12 Muffin formen, Silikon  
Silicone 12 muffin moulds set  
Conjunto 12 moldes muffin en silicone

Ref	€	Ø (cm)	h (cm)	U.Venta
66745	5,60	7	5	1



30 macarons -> 5cm  
48 macarons -> 4cm



## Molde macarons doble

Moule macarons double  
Doppel Macaronsform  
Macarons dual mould  
Molde macarons duplo

Ref	€	cm	U.Venta
66753	12,60	39x29	1



**Flexible, antiadherente y reutilizable**  
Flexible, non-stick and reusable

# TAPETES · LÁMINAS para horno



### Incluye - Includes:

- 1.- Tablas de conversión de temperatura (°C / °F)
- 2.- Peso (gr / oz)
- 3.- Volumén ml / floz / pt)
- 4.- Longitud (mm / inch)
- 5.- Reglas laterales (cm / inch)

**Flexible, antiadherente y reutilizable**  
Flexible, non-stick and reusable

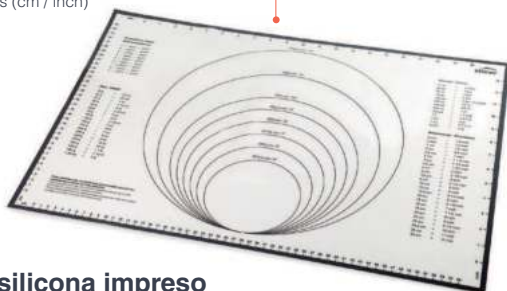

## Tapete de silicona impreso

Tapis en silicone imprime  
Bedruckte Silikonmatte  
Printed silicon mat  
Tapete de silicone impreso

Ref	€	cm	U.Venta
66759	28,90	60x40	1

**Flexible, antiadherente y reutilizable**  
Flexible, non-stick and reusable

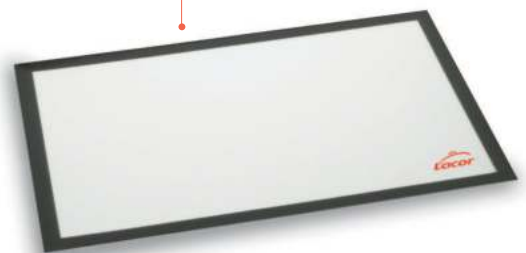

## Tapete de silicona

Tapis en silicone  
Backblech-Auflage Silikon  
Silicone covering  
Tapete de silicone

Ref	€	cm	U.Venta
66749	20,30	30x40	1
66731	28,10	60x40	1
66732	20,80	52x32 GN 1/1	1



**Permite hornear sin necesidad de utilizar papel de horno**  
Lets you bake without having to use oven paper



## Láminas antiadherentes

Feuilles antiadhésif  
Antihaft-Blätter  
Non-stick sheets  
Láminas antiaderentes

Ref	€	cm	unidades	U.Venta
66746	9,80	30x40	3	1

**Apto para todas las freidoras de aire**  
Suitable for all air fryers



- Láminas de fibra de vidrio con recubrimiento antiadherente de gran calidad.
- Ideal para colocar sobre bandejas o parrillas de hornos y deshidratadores.
- Vida útil aproximadamente de 1000 hornados.
- Diseñadas para soportar temperaturas de hasta 250°C.
- Recortable para adaptar a cualquier recipiente.
- Reutilizables, para una correcta conservación se recomienda su lavado a mano. No aptas para el lavavajillas.

- Fibreglass sheets with non-stick coating high-quality.
- Ideal for placing on baking trays, oven racks and dehydrators.
- Can be used approximately 1,000 times.
- Designed to withstand temperatures up to 250°C.
- Can be cut to fit any container.
- Reusable; in order to keep the sheets in good condition, we recommend washing by hand. Non-dishwasher safe.

# PARRILLAS · PLACAS para horno



Inox

## Parrilla

Grille  
Gitter, Rost  
Grate  
Grelha

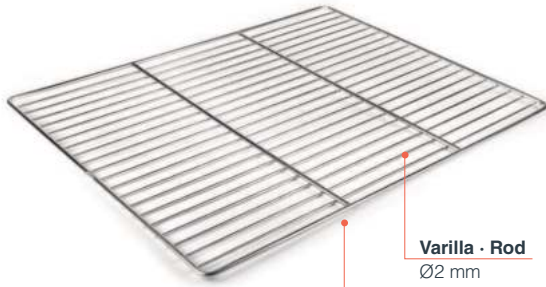

Varilla · Rod  
Ø2 mm

Varilla · Rod  
Ø5 mm

Ref	€	cm	h (cm)	U.Venta
68741	29,80	60x40	0,8	1

Inox

## Parrilla

Grille  
Gitter, Rost  
Grate  
Grelha

Varilla · Rod  
Ø6 mm



Varilla · Rod  
Ø3 mm

Ref	€	cm	Cubeta	U.Venta
66920	53,60	65X53	2/1	1
66921	20,60	53X32,5	1/1	1

AL

Aluminium



## Placa horno aluminio antiadherente

Plaque à four aluminium anti-adhésif teflon  
Backblech, Aluminium, Teflon  
Teflon non-stick coated oven aluminium tray  
Placa forno aluminio anti-aderente

Ref	€	cm	h (cm)	U.Venta
68660	37,20	60x40	1,0	1
68659	33,80	GN 1/1	1,0	1

Fe

Hierro/Iron



## Placa horno acero negro

Plaque à four tôle noire  
Backblech, Schwarzstahl  
Baking sheet black steel  
Placa de forno aço negro

Ref	€	cm	h (cm)	U.Venta
68640	36,60	60x40	0,8	1

Inox

## Placa horno

Plaque à four  
Backblech  
Baking sheet  
Placa de forno



Ref	€	cm	h (cm)	U.Venta
68740	44,20	60x40	0,8	1
68739	34,20	GN 1/1	0,8	1

AL

Aluminium



## Placa horno

Plaque à four  
Backblech  
Baking sheet  
Placa de forno

Ref	€	cm	h (cm)	U.Venta
68641	34,70	60x40	0,8	1
68642	28,00	GN 1/1	0,8	1

## Pinzas para HORNO

Inox 18/10    SI 200°C    Oven    BPA free  
Silicone    max

## Pinza para horno y bandeja GN

Pince inox pour bac Gastronorm  
Zange für GN Behälter  
Tong GN tray  
Pinça para forno e bandejas GN



Ref	€	L (cm)	U.Venta
A 62989	17,00	20	12
B 62998	17,00	20	12

Con silicona · With silicone

# Moldes INOX 18/10

Inox  
18/10

240°C  
max



## Cadena repostería

Chaîne pour pâtisserie  
Kette für Konditorei  
String for pastry  
Corrente para pastelería



Ref	€	L (m)	U.Venta
68248	12,00	1,80	12

## Flanero

Moule à flan  
Pudding-/Becherförmchen  
Pudding mould  
Forma flan



Ref	€	Ø (cm)	h (cm)	ml	U.Venta
60007	4,30	7	5,0	100	10
60008	5,20	8	5,3	200	10

Inox

## Molde cake liso

Moule à cake  
Pastetenform  
Cake mould plain  
Molde cake liso



Ref	€	cm	h (cm)	U.Venta
65925	18,40	25x12	8,5	1
65930	21,90	30x12	8,5	1

Inox

## Molde cake

Moule à cake  
Pastetenform  
Cake mould  
Molde cake

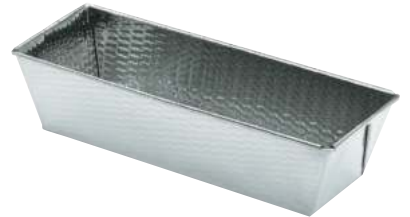

Ref	€	cm	h (cm)	U.Venta
68726	16,20	25x12	8,5	1
68731	19,50	30x12	8,5	1
68736	23,20	35x12	8,5	1

## Molde 1/2 caña desmontable redondo

Gouttière à bûche  
Terrinen-/Kuchenform "Dachrinne"  
Round cake mould  
Molde 1/2 cana desmontável redondo



Ref	€	cm	h (cm)	U.Venta
68001	39,20	25x9	6,0	1
68002	49,10	50x9	6,0	1

## Molde 1/2 caña desmontable triangular

Moule triangle "demie canne"  
Terrinen-/Kuchenform "Dachrinne",  
Three-cornered cake mould  
Molde 1/2 cana desmontável rtriangular



Ref	€	cm	h (cm)	U.Venta
68003	38,20	25,5x9,4	9,4	1
68004	47,80	50,7x9,4	9,4	1

## Marco rectangular

Rectangle  
Rahmen, rechteckig,  
Rectangular frame  
Molde rectangular



Ref	€	cm	h (cm)	U.Venta
68043	30,20	30x40	3,0	1
68048	30,40	31x48	3,0	1
68060	33,20	40x60	3,0	1
68041	30,40	30x40	5,0	1
68049	31,70	31x48	5,0	1
68061	34,40	40x60	5,0	1

## Bandeja

Plaque  
Backblech  
Baking sheet  
Bandeja



Ref	€	cm	h (cm)	U.Venta
68030	39,00	30x40	1,0	1
68031	39,40	31x48	1,0	1
68040	69,60	40x60	1,0	1



# Moldes ALUMINIO



## Molde cake

Moule à cake  
Kuchenform, konisch  
Cake mould,  
Molde cake



Ref	€	L (cm)	h (cm)	U.Venta
68825	12,20	25	7	6
68831	14,30	30	7	6
68835	15,40	35	7	6

- Amplia gama de moldes de aluminio con antiadherente para horno.
- Resistente a altas temperaturas, excelente conductor de calor.
- Recubrimiento antiadherente por toda la superficie de la pieza.

- Large gamme de moules pour four en aluminium avec antiadhésif.
- Résistant à de hautes températures, excellent conducteur de chaleur.
- Revêtement antiadhésif sur toute la surface de la pièce.

- Große Bandbreite von backofenfesten Aluminiumformen mit Antihftbeschichtung.
- Hitzebeständig, erstklassige Wärmeleitung Schnell und gleichmäßig.
- Rundum-Antihftbeschichtung.

- Wide range of non-stick aluminium moulds for the oven.
- Resistant to high temperatures, excellent heat conductor.
- The entire surface of the mould has a non-stick coating.

## Molde alto

Moule à manqué  
Käsekuchenform  
Pie mould  
Molde alto



Ref	€	Ø (cm)	h (cm)	U.Venta
68822	10,20	22	4,7	6
68827	11,10	26	5,0	6
68829	12,80	30	5,0	6
68833	14,00	32	5,2	6

- Ampla gama de moldes de aluminio antiaderente para fornos.
- Resistentes a altas temperaturas, com ótima condutividade do calor.
- Revestimento antiaderente em toda a superfície da peça.

## Set 4 flaneros

Jeu 4 Moule à flan  
4 Pudding-/Becherförmchen  
4 pcs. pudding mould  
Conjunto 4 formas flan



Ref	€	Ø (cm)	h (cm)	U.Venta
68808	14,40	8	5,2	6

## Molde rizado

Moule à tarte fond fixe  
Tortenbodenform, gewellter Rand.  
Tart mould  
Molde frizado



Ref	€	Ø (cm)	h (cm)	U.Venta
68723	10,90	24	3,7	6
68729	12,30	28	3,7	6
68732	13,00	32	3,7	6

## Molde rizado movil

Moule à tarte fond mobile  
Kuchenform, konisch  
Fruit tart mould  
Molde frizado-fundo móvel



Ref	€	Ø (cm)	h (cm)	U.Venta
68842	12,50	24	3	6
68882	16,50	28	3	6
68823	20,40	32	3	6

## Molde rizado

Moule à brioche  
Briocheform  
Brioche mould  
Molde flan frizado



Ref	€	Ø (cm)	h (cm)	U.Venta
68810	5,60	10	4,0	6
68814	7,50	14	5,5	6
68818	8,40	18	6,5	6
68821	11,40	22	10	6

## Molde savarín

Moule à Savarin  
Reisrand/Savarinform  
Savarin mould  
Molde pudim



Ref	€	Ø (cm)	h (cm)	U.Venta
68724	17,10	24x6,5	5,7	6
68862	18,50	26x6,5	6,0	6
68863	18,80	28x6,5	6,0	6

## Molde pizza

Moule à pizza  
Pizzablech  
Pizza mould  
Molde pizza



Ref	€	Ø (cm)	h (cm)	U.Venta
68824	9,90	24	1,8	6
68828	10,60	28	1,8	6
68832	13,20	32	2,0	6
68836	14,90	36	2,0	6

## Molde pizza perforado

Moule à pizza perforé  
Pizzablech, gelocht  
Perforated Pizza mould  
Molde pizza perforado



Ref	€	Ø (cm)	h (cm)	U.Venta
67824	11,40	24	1,8	6
67828	12,10	28	1,8	6
67832	12,90	32	2,0	6
67836	13,60	36	2,0	6

# Moldes **ACERO CARBONO**

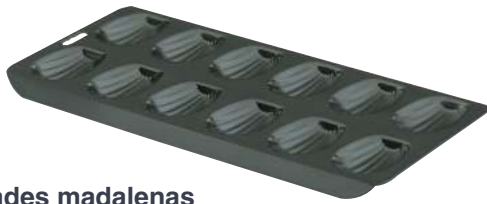

## Molde 12 cavidades madalenas

Plaque madeleine 12 alveoles  
Muffinform 12 Madeleine  
12 cups madelaine pan  
Molde cavidades 12 madalenas

Ref	€	cm	h (cm)	U.Venta
68000	15,30	39,8x19,5	2,0	1

- Ideal para preparar todo tipo de postres, pudding, gelatinas o mousses, fríos o calientes.
- Fabricados en acero al carbono.
- Revestimiento antiadherente de gran calidad sin PFOA en el interior y el exterior.
- Distribuyen el calor de manera uniforme.
- Apto para hornos hasta 240°C.
- No se recomiendan lavarlos en el lavavajillas.

- Idéal pour préparer tout type de desserts, puddings, gélamines ou mousses, froids ou chauds.
- Fabriqués en acier au carbone.
- Revêtement antiadhésif de grande qualité sans PFOA à l'intérieur et à l'extérieur.
- Distribue uniformément la chaleur.
- Compatible avec les fours jusqu'à 240°C.
- Il est déconseillé de le laver au lave-vaisselle.

- Ideal für alle Arten von Nachtisch, Pudding, Gelatine oder Mousse - kalt und warm.
- Aus Carbonstahl hergestellt.
- Qualitätsvolle Antihafbeschichtung ohne PFOA auf Innen- und Außenseite.
- Gleichmäßige Wärmeverteilung.
- Backofenfest bis 240°C.
- Vom Waschen in der Maschine wird abgeraten.

- Ideal for making all types of hot or cold desserts, puddings, jellies or mousses.
- Made of carbon steel.
- High quality PFOA-free non-stick coating on the inside and outside.
- Distributes heat evenly.
- Suitable for ovens up to 240°C.
- Dishwasher use is not recommended.

- Ideal para preparar todo o tipo de sobremesas, pudins, gelatinas ou mousses, frias ou quentes.
- Fabricados em aço ao carbono.
- Revestimento antiaderente de grande qualidade, sem PFOA no interior e no exterior.
- Distribuição uniforme do calor.
- Aptos para fornos até 240 °C.
- Não é recomendável lavá-los na máquina de lavar louça.



## Molde 12 cavidades

Plaque à biscuits 12 alveoles  
Madeleine-Backform für 12 Madeleine  
12 cups muffin pan  
Molde 12 cavidades

Ref	€	cm	h (cm)	U.Venta
68010	18,10	35x26,5	3,0	1



## Molde cake chapa antiadherente

Moule à cake tôle anti-adh.  
Back/Pastetenform, Antihaf  
Cake mould rolled B S. non s.  
Molde cake chapa aderente

Ref	€	cm	h (cm)	U.Venta
68725	8,80	25x12	8,5	6
68730	9,00	30x12	8,5	6
68735	9,90	35x12	8,5	6



## Juego 4 cornetes chapa antiadherente

Ensemble de 4 moule cornet antiadhesive  
Hornförmchen 4-tlg. antihaf  
4 pcs. non stick cream horn set  
Jogo 4 forma de cornucópia anti-aderente

Ref	€	cm	U.Venta
68936	6,70	12	6



## Molde desmontable redondo chapa antiad.

Moule rond desmontable  
Tortenbodenform  
Dismountable round mould  
M. desmontável redondo chapa anti-aderente

Ref	€	Ø (cm)	h (cm)	U.Venta
68714	10,80	24	7	1
68716	11,30	26	7	1
68718	11,40	28	7	1

# Moldes desmontables **ACERO CARBONO**

new



- Fabricados en acero al carbono.
- Antiadherente interior y exterior de máxima calidad, ecológico y libre de PFOA.
- Diseñados para elaborar recetas con masas densas, ideal para tartas, pasteles, bizcochos, etc.
- La base desmontable y el clip lateral garantizan un mejor desmoldado y una mayor facilidad de uso.
- Resistentes a altas temperaturas.
- Fondo rugoso para una distribución uniforme y retención del calor.
- Aptos para el horno, nevera y congelador.

- Fabriqués en acier carbone.
- Antiadhésif intérieur et extérieur de la plus grande qualité, écologique et sans PFOA.
- Conçus pour des recettes avec des pâtes denses, idéal pour des tartes, gâteaux, génoises, etc.
- La base démontable et la charnière latérale garantissent un meilleur démoulage et une plus grande facilité d'utilisation.
- Résistants aux hautes températures.
- Fond rugueux pour une répartition et une distribution uniforme de la chaleur.
- Aptes pour le four, le réfrigérateur et le congélateur.

- Aus Carbonstahl hergestellt.
- Mit Antihafwirkung innen und außen bester Qualität, umweltfreundlich und frei von PFOA.
- Besonders zum Bereiten von Torten, Kuchen, Biskuit und anderen Rezepten mit schwerem Teig geeignet.
- Boden ist herausnehmbar, seitlicher Clip erleichtert das Ausformen und vereinfacht die Handhabung.
- Sehr hitzebeständig.
- Aufgerauter Boden sorgt für gleichmäßige Wärmeverteilung und -aufnahme.
- Geeignet für Backofen, Kühlschrank und Tiefkühlgeräte.

- Made of carbon steel.
- Top quality non-stick inner and outer coating, environmentally friendly and PFOA-free.
- Designed for making heavy dough recipes and ideal for tarts, pies, sponge cakes, etc.
- Its spring form base and side clasp make releasing the mould quick and easy to use.
- High temperature resistant.
- Rough bottom for evenly distributing and retaining heat.
- Oven, fridge and freezer safe.

- Fabricado em aço de carbono.
- Antiaderente interior e exterior da máxima qualidade, ecológico e livre de PFOA.
- Concebido para elaborar receitas com massas densas, ideal para tartes, pastéis, biscoitos, etc.
- A base desmontável e o clip lateral garantem um melhor desenformar e maior facilidade de utilização.
- Resistente a altas temperaturas.
- Fundo rugoso para uma distribuição uniforme e uma melhor retenção do calor.
- Adequado para forno, frigorífico e congelador.

## Fondo rugoso para una distribución uniforme y retención del calor

Rough bottom for evenly distributing and retaining heat



## Clip lateral para un mejor desmoldado

Side clasp for better unmolding

## Molde desmontable ROUND

Moule demontable  
Kuchenform  
Dismountable mould  
Molde desmontável

Ref	€	Ø (cm)	h (cm)	L	U.Venta
68676	7,70	18	6,8	1,50	1
68680	8,10	20	6,8	1,90	1
68684	9,30	24	6,8	2,80	1
68686	9,90	26	6,8	3,30	1
68688	10,90	28	6,8	3,80	1

## Molde desmontable PANETTONE

Moule demontable  
Kuchenform  
Dismountable mould  
Molde desmontável



Ref	€	Ø7 (cm)	h (cm)	L	U.Venta
68696	11,70	16	13	2,00	1

# Moldes BOMBONES



Dimensiones / Sizes

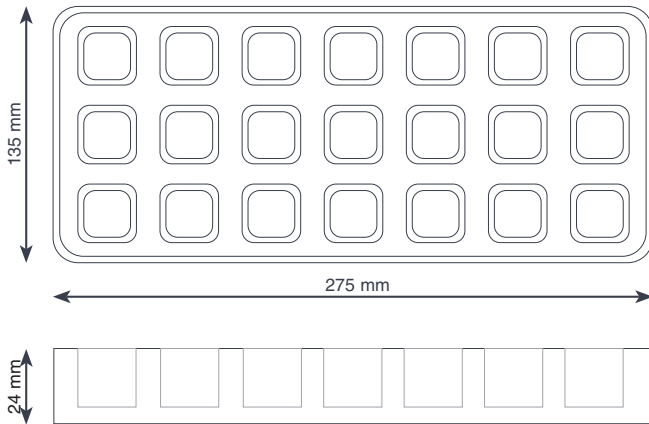

- Molde profesional para elaborar deliciosos y originales bombones.
- Fabricado en poliestireno de alta calidad.
- Se obtienen bombones perfectos y con un brillo único.
- Cómodo de utilizar: rellena el molde con chocolate fundido, retira el exceso de chocolate, deja reposar, vuelca el molde y da un pequeño golpe para que salgan los bombones.
- Fácil de limpiar y resistentes al uso diario.
- Superficie lisa para un mejor desplazamiento de la espátula a la hora de retirar el chocolate sobrante.

- Moule professionnel pour élaborer de délicieux et originaux chocolats.
- Fabriqué en polystyrène de grande qualité.
- Permet d'obtenir des chocolats parfaits avec une brillance unique.
- Facile à utiliser : Remplir le moule de chocolat fondu, retirer l'excès de chocolat, laisser reposer, retourner le moule et tapoter légèrement pour faire sortir les chocolats.
- Facile à nettoyer et résistant à l'usage quotidien.
- Surface lisse pour un meilleur mouvement de la spatule lors du retrait du chocolat excédentaire.

- Professional mould for making delicious and original chocolates.
- Made of high quality polystyrene.
- Makes perfect chocolates with a unique shine.
- Easy to use: Fill the mould with melted chocolate. Remove the excess chocolate. Let sit. Flip the mould over and tap gently to get the chocolates out.
- Easy to clean and stands up to daily use.
- Smooth finish so a spatula will slide easily over the surface when removing extra chocolate.



## Molde bombón semiesférica

Moule pour chocolats hemisphere  
Halbkugelform Pralinengiessform  
Half-sphere chocolate mould  
Molde para bombons semi-esférica

Ref	€	Ø (mm)	h (mm)	ml	U.Venta
66870	17,40	28	19	7	1



## Molde bombón corazón

Moule pour chocolats coeur  
Herzform Pralinengiessform  
Heart chocolate mould  
Molde para bombons coração

Ref	€	mm	h (mm)	ml	U.Venta
66871	17,40	25x20	11,5	6	1

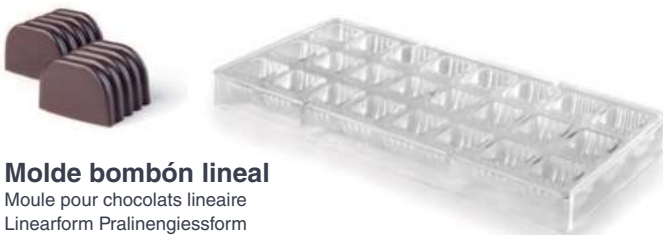

## Molde bombón lineal

Moule pour chocolats lineaire  
Linearform Pralinengiessform  
Linear chocolate mould  
Molde para bombons linear

Ref	€	mm	h (mm)	ml	U.Venta
66872	17,40	25,5x24,5	17	10	1



## Molde bombón hoja

Moule pour chocolats feuilere  
Blatt Pralinengiessform  
Leaf chocolate mould  
Molde para bombons folha

Ref	€	mm	h (mm)	ml	U.Venta
66875	17,40	32x19	12	6	1



## Molde bombón cuadrado

Moule pour chocolats carrée  
Pralinengiessform, vierecking  
Square chocolate mould  
Molde para bombons quadrado

Ref	€	mm	h (mm)	ml	U.Venta
66874	17,40	25x25	17	10	1



## Molde bombón ondulado

Moule pour chocolats ondulé  
Onduliert Pralinengiessform  
Ondulated chocolate mould  
Molde para bombonsondulado

Ref	€	mm	h (mm)	ml	U.Venta
66877	17,40	32x25	12,5	7	1

# Aros REPOSTERÍA



- Fabricados en acero inoxidable 18/10.
- Ideal para brisa, hojaldre y choux.
- Consigue bordes regulares, bien denidos y con una extracción perfecta de la base. Acabado excepcional.
- Disponible en distintas formas y tamaños.
- Aros perforados: innovadores aros de acero inoxidable microperforados. Las microperforaciones permiten la circulación de aire durante la cocción, consiguiendo una cocción más rápida y homogénea.

- Fabriquée en acier inoxydable 18/10.
- Idéal pour la pâte brisée, la pâte feuilletée et la pâte à choux.
- Obtenez des bords réguliers, bien dénis, et avec une extraction parfaite de la base. Finition exceptionnelle.
- Disponible en plusieurs formes et tailles.
- Cercles perforés : cercle en acier inoxydable micro-perforé innovant. Les micro-perforations permettent la circulation d'air pendant la cuisson, obtenant ainsi une cuisson plus rapide et homogène.

- Manufactured in stainless steel 18/10.
- Ideal for shortcrust, puff and choux pastry.
- Get even, well-dened edges and a perfect extraction of the base. Exceptional nish.
- Available in various different shapes and sizes.
- Perforated ring: innovative microperforated stainless steel tart ring. The microperforations enable air to circulate during cooking, ensuring faster and more even cooking.

## Aro redondo Mouse

Cercle rond Mousse  
Kuchen-/Ausstechformen, rund, Mousse  
Round cake ring Mousse  
Aro redondo Mouse



Ref	€	Ø (cm)	h (cm)	U.Venta
68506	3,00	6	4,5	12
68508	3,10	8	4,5	12
68509	3,20	9	4,5	12
68510	3,30	10	4,5	12
68512	4,20	12	4,5	12
68514	4,90	14	4,5	12
68516	6,80	16	4,5	6
68518	7,90	18	4,5	6
68520	8,60	20	4,5	6
68522	10,00	22	4,5	1
68524	10,40	24	4,5	1
68526	11,50	26	4,5	1

## Aro redondo Entremet

Cercle rond Entremet  
Kuchen-/Ausstechformen, rund, Entremet  
Round cake ring Entremet  
Aro redondo Entremet



Ref	€	Ø (cm)	h (cm)	U.Venta
68308	3,10	8	3,5	12
68310	3,10	10	3,5	12

## Aro redondo

Cercle rond  
Kuchen-/Ausstechformen, rund  
Round cake ring  
Aro redondo



Ref	€	Ø (cm)	h (cm)	U.Venta
68406	3,00	6	4	12
68407	3,10	7,5	4	12
68408	3,20	8	4	12
68410	3,30	10	4	12
68412	5,20	12	4	12
68414	4,90	14	4	6
68416	6,70	16	4	6
68418	8,00	18	4	6
68420	9,70	20	4	1
68422	9,80	22	4	1
68424	11,10	24	4	1

## Aro redondo Vacherin

Cercle rond Vacherin  
Kuchen-/Ausstechformen, rund, Vacherin  
Round cake ring Vacherin  
Aro redondo Vacherin



Ref	€	Ø (cm)	h (cm)	U.Venta
68607	4,20	7	6	12
68608	4,30	8	6	12
68609	4,40	9	6	12
68610	4,60	10	6	12
68612	6,10	12	6	6
68614	7,10	14	6	6
68616	9,70	16	6	6
68618	10,90	18	6	1
68620	14,10	20	6	1
68622	15,00	22	6	1
68624	16,20	24	6	1
68626	17,30	26	6	1
68628	18,90	28	6	1

Inox  
18/10



### Molde cuadrado

Carre pour pâtisserie  
Kuchen-/Ausstech formen, vierecking  
Square pastry mould  
Molde quadrado

Ref	€	cm	h (cm)	U.Venta
68460	4,70	6x6	4	12
68480	4,80	8x8	4	12
68411	4,90	10x10	4	12
68441	5,20	14x14	4	6
68240	6,60	20x20	4	6

Inox  
18/10



### Aro tarta borde vuelto

Cercle "goutte"  
Tortenring  
Tart ring  
Aro torta

Ref	€	Ø (cm)	h (cm)	U.Venta
68107	3,60	8	2,2	6
68121	3,80	10	2,2	6
68120	7,60	20	2,2	1



Inox  
18/10

### Aro redondo perforado

Cercle rond perforée  
Kuchen-/Ausstechformen, rund, gelocht  
Perforated round cake ring  
Aro redondo perforada



Ref	€	Ø (cm)	h (cm)	U.Venta
68537	3,10	7	2,0	6
68532	3,90	12	2,0	6
68536	5,00	16	2,0	6
68538	5,50	18	2,0	6
68540	6,30	20	2,0	6
68544	7,60	24	2,0	6
68558	8,50	28	2,0	6
68547	4,30	7	3,5	6
68552	6,30	12	3,5	6
68546	7,70	16	3,5	6
68548	8,60	18	3,5	6
68550	9,60	20	3,5	6
68554	11,50	24	3,5	6
68568	13,50	28	3,5	6

Inox  
18/10

### Aro rectangular perforado

Cercle rectangulaire perforée  
Kuchen-/Ausstechformen, rechteckig, gelocht  
Perforated rectangular cake ring  
Aro rectangular perforada



Ref	€	cm	h (cm)	U.Venta
68590	5,20	7x20	2,0	6
68598	6,40	8x28	2,0	6
68591	7,90	7x20	3,5	6
68597	10,40	8x28	3,5	6

Inox  
18/10



### Juego aros repostería

Ensemble de cercles à pâtisserie  
Ausstechformen, Set  
Pastry rings set  
Jogo aros de pasteleria

Ref	€	Forma	cm	h (mm)	U.Venta
68203	10,80	Redondo · Round	Ø7,7	5	1
		Redondo · Round	Ø10,7	5	
		Cuadrado · Square	8,2x8,2	5	
		Triángulo · Triangle	6x6	5	

### Aro repostería extensible

Cercle extensible  
Kuchenform, verstellbar  
Adjustable pastry ring  
Aro extensível pasteleria



Ref	€	Ø (cm)	h (cm)	U.Venta
68200	17,70	16-30	7,0	1

Inox  
18/10

### Aro cuadrado perforado

Cercle carre perforée  
Kuchen-/Ausstechformen, vierecking, gelocht  
Perforated square cake ring  
Aro quadrado perforada



Ref	€	cm	h (cm)	U.Venta
68557	3,70	7x7	2,0	6
68556	6,10	16x16	2,0	6
68560	7,60	20x20	2,0	6
68567	5,00	7x7	3,5	6
68566	9,60	16x16	3,5	6
68570	11,70	20x20	3,5	6

Inox  
18/10

### Aro oval perforado

Cercle oval perforée  
Kuchen-/Ausstechformen, oval, gelocht  
Perforated oval cake ring  
Aro oval perforada



Ref	€	cm	h (cm)	U.Venta
68580	5,00	7x20	2,0	6
68588	6,30	8x28	2,0	6
68581	7,20	7x20	3,5	6
68587	9,90	8x28	3,5	6

---

# Eléctrico

---

Electric





**Eléctrico**  
Electric

**Calentadores**  
Lamps



# Robot de cocina **CookingMe**



Incluye **RECETARIO**  
 RECIPE BOOK included

· *Semiprofessional use* ·



- Diseñado para hacerte el día a día más fácil en tu cocina.
- Realiza todas tus recetas de manera rápida y sin esfuerzo.
- Múltiples funciones: cocer, sofreír, picar, triturar, cocer al vapor, mezclar, batir, amasar, emulsionar y pesar, solo tienes que darle la orden.
- Panel de control de fácil manejo.
- Incluye accesorios para elaborar todo tipo de recetas.

- Conçu pour vous faciliter la tâche dans votre cuisine quotidienne.
- Il réalise toutes les recettes de manière rapide et sans effort.
- Multiples fonctions : cuire, saisir, hacher, broyer, cuire à la vapeur, mélanger, mixer, pétrir, émulsionner et peser, vous n'avez qu'à lui donner l'ordre.
- Tableau de commande facile à manœuvrer.
- Il inclut les accessoires pour élaborer tout type de recettes.

- Macht das Leben in der Küche leichter.
- Alle Rezepte lassen sich schnell und einfach zubereiten.
- Multitalent mit vielen Funktionen: kochen, anbraten, zerkleinern, mahlen, dampfgaren, vermischen, mixen, kneten, emulgieren und wiegen auf Knopfdruck möglich.
- Übersichtliches Bedienfeld.
- Mit komplettem Zubehör.

- Designed to make everyday life easier in your kitchen.
- Makes all your recipes quickly and effortlessly.
- Multiple functions: cook, sauté, chop, shred, steam, mix, beat, knead, emulsify and weigh, you just have to give the order.
- Easy-to-use control panel.
- Includes accessories to make all kinds of recipes.

- Concebido para tornar mais fáceis as tarefas da cozinha.
- Elabora todas as tuas receitas de maneira rápida e sem esforço.
- Várias funções: cozer, refogar, picar, triturar, cozer a vapor, misturar, bater, amassar, emulsionar e pesar.
- Painele de controlo fácil de utilizar.
- Inclui acessórios para elaborar todo o tipo de receitas.

## TODO EN UNO · ALL-IN-ONE



Cuece · Boil



Sofríe · Sauté



Cuece al vapor  
 Steam



Pica · Chop



Tritura · Beat



Mezcla · Mix



Bate y amasa  
 Beat and knead



Emulsiona  
 Emulsify



Pesa · Weigh



## CookingMe

Ref	€	U.Venta	
69561E	849,00	1	CookingMe + Recetario en ESPAÑOL · Recipe book in SPANISH
69561F	849,00	1	CookingMe + Recetario en FRANCÉS · Recipe book in FRENCH
69561I	849,00	1	CookingMe + Recetario en INGLES · Recipe book in ENGLISH

Ref	Tensión/ Voltage	Potencia/Power	Velocidad Speed	Temp./Temp.	Capacidad capacity	Funciones/Memorias Functions/Memories	Báscula Scale	Dimensiones Sizes	Peso/Weight
69561E 69561F 69561I	220-240 V; 50/60 Hz	Motor:1000 W Calent./Heating:1000 W	60 - 10.000 r.p.m	37°C - 120°C	2,0 L	15 / 3	5 Kg (div.: 1 g)	39x30x33 cm	7,80 Kg

## Accesorios

Accessoires · Zubehör · Accessories · Acessórios

### Recetario

Cookbook  
Kochbuch  
Cookbook  
Livro de receitas



Ref	€	U.Venta	
R69561N	31,00	1	<b>Español</b> · Spanish
R69561P	31,00	1	<b>Francés</b> · French
R69561Q	31,00	1	<b>Ingles</b> · English

### Jarra

Pitcher  
Kanne  
Picher  
Jarra



Ref	€	L	U.Venta
R69561A	180,40	2,0	1

### Tapa para jarra

Couvercle pour pitcher  
Deckel für Kanne  
Lid for picher  
Tampa para jarra



Ref	€	U.Venta
R69561E	14,60	1

### Vaso dosificador

Verre doseur  
Dosierbecher  
Measuring glass  
Copo dosificador



Ref	€	ml	U.Venta
R69561W	2,50	100	1

### Cestillo colador

Panier passoire vapeur  
Dampfsieb  
Steam strainer basket  
Cesto coador



Ref	€	U.Venta
R69561C	17,60	1

### Anilla fijación/bloqueo

Anneau de fixation/verrouillage  
Dichtungsring/Arretierung  
Fixing ring  
Anilla de fixação/bloqueio



Ref	€	U.Venta
R69561Z	2,50	1

### Cuchillas

Couteaux  
Klinge  
Blades  
Lâminas



Ref	€	U.Venta
R69561B	35,10	1

### Amasador

Accessoire à pétrir  
Kneteinsatz  
Kneader  
Acessório para amassar



Ref	€	U.Venta
R69561V	29,00	1

### Emulsionador

Fouet  
Rühraufsatz (Schmetterlig)  
Emulsifier  
Batedor de borboleta



Ref	€	U.Venta
R69561T	4,80	1

**NO apta para el lavavajillas**  
NOT dishwasher safe

**NO INCLUIDA**  
NOT INCLUDED

### Espátula

Spatule  
Kelle  
Spatula  
Espátula



Ref	€	U.Venta
R69561S	7,20	1

### Báscula

Balance  
Waage  
Scale  
Balança



Ref	€	Kg	U.Venta
R69561F	31,70	5,0	1

### Vaporera

Ensemble vapeur  
Dampfeinsatz  
Steam  
Conjunto de vapor



Ref	€	U.Venta
R69561D	84,30	1

### Accesorios aptos para la limpieza en el lavavajillas

Accessoires adaptés au nettoyage au lave-vaisselle · Zubehör angepasst für in der Spülmaschine reinigen · Accessories suitable for cleaning in the dishwasher  
Acessórios adaptado para a limpeza na máquina de lavar



**Pan y masas**  
Bread and pasta



**Salsas**  
Sauces



**Sopas**  
Soups



**Verduras**  
Vegetables



**Pescados**  
Fish



**Carnes**  
Meat



**Bebidas**  
Drinks



**Postres**  
Desserts

# Arroceras WHITE



· Household use ·



- Cubeta interna extraíble con recubrimiento antiadherente 100% ECO y libre de PFOA.
- Cestillo de vapor removible para cocer verduras, patatas, pescado, etc.
- Incluye cuchara y vaso medidor.
- Tapa fabricada en vidrio con salida de vapor para evitar la cocción excesiva de los alimentos.
- Función de conservación del calor y protección contra la ebullición en seco.
- Luces indicadoras para cocinar y mantener caliente.
- 100% estable gracias a sus pies antideslizantes.
- Muy fácil de limpiar.

- Cuve interne extractible avec revêtement antiadhésif 100% ECO et sans PFOA.
- Panier de vapeur amovible pour cuire des légumes, des pommes de terre, du poisson, etc.
- Inclut une cuillère et un verre doseur.
- Couvercle fabriqué en verre avec sortie de vapeur pour éviter la cuisson excessive des aliments.
- Fonction de conservation de la chaleur et protection contre l'ébullition à sec.
- Témoins lumineux pour cuire et maintenir au chaud.
- 100% stable grâce à ses pieds antidérapants.
- Très facile à nettoyer.

- Herausnehmbarer Behälter mit Antihafbeschichtung, 100 % ECO-kon form und frei von PFOA.
- Herausnehmbarer Einlegeboden zum Kochen von Gemüse, Kartoffeln, Fisch usw.
- Mit Schöpflöffel und Messbecher.
- Deckel aus hitzebeständigem Glas. Dampfabzugsloch verhindert verkochen von Lebensmittel.
- Warmhaltefunktion und Schutz vor Wasserverdampfung.
- Leuchtanzeige für Koch- und Warmhaltemodus.
- 100 % standfest mit Antirutschfüßen.
- Sehr einfach zu reinigen.

- Removable inner pot with 100% ECO PFOA free non-stick coating.
- Removable steam basket to cook vegetables, potatoes, fish, etc.
- Includes spoon and measuring cup.
- Lid made of glass with steam outlet to prevent overcooking.
- Warm function and boil-dry protection.
- Cook and Warm indicator lights.
- 100% stability thanks to its non-slip feet.
- Very easy to clean.

**Preparara en muy poco tiempo y de forma perfecta un arroz o verduras al vapor**  
Prepares rice or steamed vegetables in very little time and in a perfect way



**Marcaje interior en la cubeta**  
Marking inside the cuvette



- Cuvete interna extraível com revestimento antiaderente 100% ECO e semPFOA.
- Cesta de vapor removível para cozer verduras, batatas, peixes, etc.
- Inclui colher e copo de medir.
- Tampa fabricada em vidro, com saída de vapor para evitar a cocção excessiva dos alimentos.
- Função de conservação do calor e proteção contra a ebulição em seco.
- Indicadores luminosos para cozinhar e manter quente.
- 100% estável, graças às suas patas antideslizantes.
- Muito fácil de limpar.

· Professional use ·

## Arrocera

Cuiseur à riz  
Reiskocher  
Rice cooker  
Arrozeira/vaporeira

	Ref	€	W	L	U.Venta	
<b>A</b>	69233	52,50	700	1,80	1	
<b>B</b>	69346	187,10	1300	3,6	1	<b>new</b>
	R69346F	14,90	-	-	1	Vaporera · Steam



Ref	Tensión/Voltage	Potencia/Power	Capacidad/Capac.	Raciones/Servings	Medidor/Glass	Dimensiones Sizes	D. con vaporera Sizes with steam	Peso Weight
69233	220-240 V; 50/60 Hz	700 W	1,80 L	10	150 g arroz (rice) 160 ml agua (water)	32x28,5x25,5 cm	32x28,5x30,5 cm	2,30 Kg
69346	220-240 V; 50/60 Hz	1300 W	3,60 L	20	150 g arroz (rice) 160 ml agua (water)	41,5x35x30 cm	-	3,75 Kg

# Cocedor de huevos TRI & SIX OVUM

new



· Household use ·



- Fabricados con base de acero inoxidable 18/10 y tapa transparente libre de BPA.
- Diseñados para cocinar huevos de diferentes tamaños y en 3 formas diferentes: huevo duro, huevo mollet o huevo pasado por agua.
- Capacidad para cocer hasta 3 huevos a la vez (69343-Tri Ovum).
- Capacidad para cocer hasta 6 huevos a la vez (69344-Six Ovum).
- Apagado automático y señal acústica automática al terminar el proceso de cocción.
- Incluyen un vaso medidor (70 ml) con perforador que indica la cantidad de agua que hay que introducir.
- Totalmente desmontables y muy fácil de limpiar.

- Fabriqués avec une base en acier inoxydable 18/10 et un couvercle transparent sans BPA.
- Conçus pour cuire des oeufs de différentes tailles et de 3 façons différentes : oeuf dur, oeuf mollet ou oeuf à la coque.
- Capacité pour cuire jusqu'à 3 oeufs à la fois (69343-Tri Ovum).
- Capacité pour cuire jusqu'à 6 oeufs à la fois (69344-Six Ovum).
- Arrêt automatique et signal sonore automatique à la fin du processus de cuisson.
- Inclut un verre doseur (70 ml) avec perforateur qui indique la quantité d'eau à mettre selon le type d'oeuf à faire cuire.
- Entièrement démontable et très facile à nettoyer.

- Edelstahlsockel (18/10), transparenter Deckel (BPA-frei)
- Zum Kochen unterschiedlich großer Eier in drei Härtegraden: hart, mittelweich und weich gekochtes Ei.
- Kann 3 Eier auf einmal kochen (Tri Ovum 69343).
- Kann 6 Eier auf einmal kochen (Six Ovum 69344).
- Mit Abschaltautomatik und Tonsignal am Ende des Kochvorgangs.
- Messbecher (70 ml) mit Eierpiekser gibt genau die Wassermenge zum Kochen verschiedener Eier an.
- Komplett zerlegbar und kinderleicht zu reinigen.

- Made with 18/10 stainless steel and a BPA free transparent lid.
- Designed for cooking different size eggs in three different ways, hard boiled, mollet eggs or soft boiled eggs.
- Capacity for making up to 3 (69343) / 6 (69344) eggs at once.
- Automatic shut-off and beeps when the boiling process is done.
- Includes a measuring cup (70ml) with a perforator that shows the amount of water to use depending on the kind of eggs you want to make.
- Can be completely disassembled and it's very easy to clean.

- Base de aço inoxidável 18/10 e tampa transparente, sem BPA.
- Concebido para cozer ovos de diferentes tamanhos e de 3 maneiras diferentes: ovo duro, ovo mollet (macio) e ovo passado por água
- Capacidade para cozer até 3 ovos em simultâneo (69343-Tri Ovum).
- Capacidade para cozer até 6 ovos em simultâneo (69344-Six Ovum).
- Desconexão automática e sinal acústico automático ao terminar o processo de ebulição.
- Inclui um copo medidor (70 ml) com perfurador, que indica a quantidade de água a introduzir segundo o tipo de cocção pretendido.
- Totalmente desmontável e fácil de limpar.



Huevo DURO  
HARD-BOILED egg



Huevo MOLLET  
Egg MOLLET



Huevo PASADO POR AGUA  
BOILED egg



## Cocedor de huevos TRI OVUM

Cuiseur à oeufs  
Eierkocher  
Egg cooker  
Máquina de cozer ovos

Ref	€	W	Capac.	U.Venta
69343	23,90	210	3 huevos	1

## Cocedor de huevos SIX OVUM

Cuiseur à oeufs  
Eierkocher  
Egg cooker  
Máquina de cozer ovos

Ref	€	W	Capac.	U.Venta
69344	34,40	210	6 huevos	1

Ref	Tensión/Voltage	Potencia/Power	Capacidad/Capacity	Cap. vaso/Glass cap.	Dimensiones/Sizes	Peso/Weight
69343	220-240 V; 50/60 Hz	210 W	3 huevos · eggs	70 ml	20,2x8,6x13,5 cm	0,60 Kg
69344	220-240 V; 50/60 Hz	210 W	6 huevos · eggs	70 ml	23,5x13x14 cm	1,12 Kg

# Cocedor · Asador de SALCHICHAS

new

Inox



· Professional use ·



- Fabricada en acero inoxidable de alta calidad.
- Ideal para cocinar al vapor salchichas, mazorcas de maíz, etc.
- Amplia cubeta de cristal y 3 pinchos para calentar los panecillos o bollos.
- Termostato regulable. Calentamiento rápido y efectivo.
- Dos interruptores independientes para cocinar simultáneamente o por separado las salchichas y los panes.
- NO necesita aceite ni grasa.
- Pies de goma antideslizantes para una mayor estabilidad.

- Fabriqué en acier inoxydable de grande qualité.
- Idéale pour cuire à la vapeur des saucisses, des épis de maïs, etc.
- Grand cylindre en verre et 3 plots pour faire chauffer les petits pains.
- Thermostat réglable. Chauffe rapide et efficace.
- Deux interrupteurs indépendants pour faire cuire simultanément ou séparément les saucisses et les pains.
- Ne nécessite ni huile ni graisse.
- Pieds en caoutchouc antidérapant pour une meilleure stabilité.

- Made of high quality stainless steel.
- Perfect for steaming sausages, corn on the cob, etc.
- The large glass pan and three sticks for heating buns.
- Adjustable thermostat, fast and effective heating.
- Two independent switches for cooking sausages and buns simultaneously or separately.
- Does not need oil or grease.
- Rubber non-slip feet for greater stability.

## Cocedor de salchichas

Machine à hot-dogs  
Hot dog Wärmer  
Sausage cooker  
Máquina de cozer salsichas

Ref	€	W	L	U.Venta
69543	464,00	540	1,0	1

Ref	Tensión/Voltage	Potencia Power	Temperatura Temperature	Capacidad Capacity	Altura tubos pan Bread tube height	Contenedor Container	Cestillo Basket	Dimensiones/Sizes	Peso/Weight
69543	220-240 V; 50/60 Hz	540 W	35°C - 100°C	1,0 L	18 cm	Ø20x24 cm	Ø17x21 cm	24x50x38,5 cm	10 Kg



- Fabricado en acero inoxidable de alta calidad
- Posibilidad de asar y calentar simultáneamente cualquier tipo de salchicha.
- Ideal para cualquier restaurante, bar, food truck, etc.
- Parrilla con 7 rodillos con rotación de 360° para asegurar una cocción uniforme de los alimentos.
- 2 zonas de cocción con reguladores de temperatura independientes.
- Fácil limpieza. Bandeja de goteo extraíble.
- Pies de goma antideslizantes para una mayor estabilidad.

- Fabriqué en acier inoxydable de grande qualité.
- Possibilité de cuire et faire chauffer simultanément tout type de saucisse.
- Idéal pour les restaurants, bars, food trucks, etc.
- Grill avec 7 rouleaux rotatifs à 360° pour garantir une cuisson uniforme des aliments.
- 2 espaces de cuisson avec thermostats indépendants.
- Nettoyage facile. Plateau recueille-gouttes extractible.
- Pieds en caoutchouc antidérapant pour une meilleure stabilité.

- Made of high quality stainless steel
- Any kind of sausage can be grilled or heated simultaneously
- Perfect for any restaurant, bar, food truck, etc.
- Grill with 7 rollers with 360° rotation to ensure food is cooked uniformly
- Two cooking areas with independent temperature regulators
- Easy to clean Removable drip tray
- Rubber non-slip feet for greater stability

## Asador de salchichas

Grill à hot-dogs  
Würstchengrill  
Sausage roaster  
Assador de salsichas

Ref	€	W	U.Venta
69547	520,80	590	1

Ref	Tensión/Voltage	Potencia/Power	Temperatura/Temp.	Tubos/Tubes	Distancia entre tubos Dist. between tubes	Dimensiones/Sizes	Peso/Weight
69547	220-240 V / 50 Hz	590 W	30°C - 170°C	50 cm	1 cm	65x35,5x28 cm	10.5 Kg

# Máquinas de HELADO

Inox  
18/10



· Household use ·



## Helados 100% naturales

100% natural ice creams

- Una nueva forma de hacer helado cremoso y saludable.
- Puedes realizar infinidad de helados de; fresa, plátano, kiwi, mango, piña, melón, etc.
- Ideal para dietas especiales: sin leche, sin azúcar, sin gluten.

- Une nouvelle façon de faire des glaces crémeuses et saines.
- Vous pouvez réaliser une infinité de glaces : à la fraise, à la banane, au kiwi, à la mangue, à l'ananas, à l'orange, au melon, etc.
- Idéale pour les régimes alimentaires spéciaux : sans lait, sans sucre, sans gluten.

- Eine neue Art cremiges und gesundes Eis herzustellen.
- Sie können unzählige Eissorten herstellen: Erdbeere, Banane, Kiwi, Mango, Ananas, Orange, Melone usw.
- Ideal für besondere Ernährungsweisen: ohne Milch, ohne Zucker, glutenfrei.

- A new way to make creamy and healthy ice cream.
- You can make a wide variety of ice creams; strawberry, banana, kiwi, mango, pineapple, orange, melon, etc.
- Ideal for special diets: milk-free, sugar-free, gluten-free.

- Uma nova maneira de elaborar um gelado cremoso e saudável.
- Podes preparar uma grande variedade de gelados de morango, banana, kiwi, mango, ananás, laranja, melão, etc.
- Ideal para dietas especiais: sem leite, sem açúcar, sem glúten.



## Máquina de helado MyCream

Machine de crème glacée

Eis Maschine

Ice cream machine

Máquina de gelado

Ref	€	W	L	U.Venta
69315	468,30	150	1,40	1

Ref	Tensión/Voltage	Potencia/Power	Temperatura/Temp.	Capacidad/Capacity	Tiempo/Timer	Dimensiones/Sizes	Peso/Weight
69315	220-240 V / 50 Hz	150 W	-18°C / -35°C	1,40 L	60 min.	38x29x31 cm	10,30 Kg



### Helados 100% naturales, saludables y bajo en calorías con fruta natural congelada

100% natural ice creams, healthy and low-calorie ice creams with frozen natural fruit

### 5 cortes con 5 colores para tus vegetales, frutas, quesos, nueces y chocolate

5 cuts and 5 colours for your vegetables, fruit, cheeses, walnuts and chocolate



## Corta vegetales + máquina de helado COSMO

Hachoir légumes + machine à fruitcreme glacée

Gemüseschneider + Obst-Eis machine

Vegetables cutter + ice fruit machine

Corta vegetales + máquina de gelado de fruta

Ref	€	W	U.Venta
69115	80,30	150	1



### Accesorio para helado de frutas

Fruit ice cream accessory

### 5 cuchillas de colores

5 colored blades

Ref	Tensión/Voltage	Potencia/Power	Cuchillas/Blades	Dimensiones/Sizes	Peso/Weight
69115	220-240 V; 50/60 Hz	150 W	6	24,5x22,5x19,5 cm	1,89 Kg

# Colección YOGURTERAS



Incluye **RECETARIO**  
RECIPE BOOK included

· Household use ·



- Diseñadas para elaborar yogur, kéfir, yogur griego y queso fresco casero de la textura y sabor que desees. Más sanos y naturales.
- Prácticas y muy fáciles de usar. Supersilenciosas.
- Tiempo de preparación de 8-14 h.
- Apagado automático con señal acústica al finalizar el proceso.
- Incluyen un práctico recetario para elaborar todo tipo de yogures, queso fresco y kéfir.

- Conçue pour préparer du yaourt, Kéfir, yaourt grec et fromage blanc fait maison avec la texture et le goût. Plus sain et plus naturel.
- Pratiques et très faciles à utiliser. Très silencieuses.
- Durée de préparation : 8-14 h.
- Arrêt automatique avec signal sonore à la fin de la préparation.
- Inclut un livre de recettes pour préparer tous types de yaourts, fromages blancs et kéfirs.

- Für die Herstellung von Joghurt oder selbstgemachtem Kefir mit der Textur und dem Geschmack Ihrer Wahl. Gesünder und natürlicher.
- Praktisch und sehr einfach zu bedienen.
- Dauer 8-14 Std.
- Automatische Abschaltung mit akustischem Signal am Ende des Prozesses.
- Es enthält ein praktisches Rezeptheft für die Herstellung aller Arten von Joghurt, Frischkäse und Kefir.

- Designed to make yoghurt or homemade kefir with the texture and flavour of your choice. Healthier and more natural.
- Practical and very easy to use. Super silent.
- Preparation time 8-14 h.
- Switches off automatically with an audible beep at the end of the process.
- Includes a practical recipe booklet for making all kinds of yoghurt, fresh cheese and kefir.

- Para elaborar iogurte, Kéfir, iogurte grego e queijo fresco caseiro com a sua textura e sabor preferidos. Mais saudável e natural.
- Prática e muito fácil de usar. Super silenciosa.
- Tempo de preparação máximo de 8-14 h.
- Desconexão automática com sinal acústico ao finalizar a elaboração.
- Inclui sugestões de receitas para elaborar todo o tipo de iogurtes, queijo fresco e kefir.



## Set 7 tarros

Set 7 bocaux  
7-Tlg. Gläser ein  
Set 7 jars  
Conjunto de 7 potes

Ref	€	U.Venta	
69244	10,90	7	<b>Set 7 tarros cristal</b> · Set 7 glass jar
R69245B	1,50	7	<b>Tarro de cristal</b> · Glass jar

Yogurt



Queijo  
Cool



Kefir



Yogurt

## Yogurtera de vasos MULTI

Yaourtière à pots  
Joghurt-Maker mit Glasbehältern  
Yoghurt maker with jars  
Iogurteira de frascos

Ref	€	W	U.Venta
69245	45,40	20	1

7 tarros de cristal  
7 glass jars



Ref	Tensión/Voltage	Potencia/Power	Temporizador/Timer	Capacidad/Capacity	Dimensiones/Sizes	Peso/Weight
69245	220-240 V; 50/60 Hz	20 W	1 -14 h	190 ml	Ø25x12 cm	1,80 Kg



## Yogurtera WHITE

Yaourtière  
Joghurt-Maker  
Yoghurt maker  
logurteira



**Despiece**  
Exploded view



**Filtro para yogur griego y queso fresco**  
Filter for greek yoghurt and fresh cheese



Ref	€	W	U.Venta
69246	39,60	20	1

Ref	Tensión/Voltage	Potencia/Power	Capacidad/Capacity	Dimensiones/Sizes	Peso/Weight
69246	220-240 V; 50/60 Hz	20 W	1,0 L (Filtro · Filter) 1,6 L (Pequeño · Small) 1,8 L (Grande · Big)	18x16x24 cm	0,85 Kg

**Función especial para elaborar KÉFIR**  
Special function to make KEFIR



## Yogurtera MAXI

Yaourtière  
Joghurt-Maker  
Yoghurt maker  
logurteira



*new*

Ref	€	W	L	U.Venta
69243	40,50	20	2,0	1

Ref	Tensión/Voltage	Potencia/Power	Capacidad/Capacity	Dimensiones/Sizes	Peso/Weight
69243	220-240 V; 50/60 Hz	20 W	2,0 L	Ø20x23 cm	1,17 Kg



## Yogurtera HERA

Yaourtière  
Joghurt-Maker  
Yoghurt maker  
logurteira



*new*

Ref	€	W	L	U.Venta
69345	38,80	20	1,0	1

Ref	Tensión/Voltage	Potencia/Power	Capacidad/Capacity	Dimensiones/Sizes	Peso/Weight
69345	220-240 V; 50/60 Hz	20 W	1,0 L	Ø16,8x18,8 cm	0,70 Kg





# Colección **BATIDORAS · AMASADORAS CON BOL**



· Professional use ·



- Batir, mezclar y amasar productos para la preparación de alimentos.
- Velocidad regulable, doble movimiento de giro, rotativo y orbital.
- Brazo basculante para acoplar los distintos accesorios.

- Battre, mélanger et pétrir des produits pour la préparation d'aliments.
- Vitesse réglable, double mouvement de rotation, rotatif et orbital.
- Bras pivotant pour fixer aisément les différents accessoires.

- Schlagen, Mischen und Kneten von Produkten zur Zubereitung von Nahrungsmitteln.
- Regelbare Geschwindigkeit, doppelte Drehbewegung, rotatorisch und orbital.
- Schwenkarm um die verschiedenen Zubehörteile einzustecken.

- Beat, mix and knead products to food preparation.
- Adjustable speed, double twisting, rotating and orbital motion.
- Swing arm for connection of different accessories.

- Bater, misturar e amassar produtos para a preparação de alimentos.
- Velocidade regulável, duplo movimento rotativo e orbital.
- Braço basculante para acoplar os diferentes acessórios.



## Batidora amasadora PROFESIONAL

Batteur pétrisseur  
Mix- und kneetmaschine  
Mixer-kneader  
Batedeira amassadora

Ref	€	W	L	U.Venta
69084	864,50	300	5,0	1

Ref	Tensión/Voltage	Potencia/Power	Velocidad/Speed	Velocidad/Speed	Capacidad/Cap.	Dimensiones/Sizes	Peso/Weight
69084	220-240 V; 50/60 Hz	300 W	3	130 - 850 r.p.m.	5,0 L	23x14,5x41 cm	19 Kg



· Household use ·



1,2 Kg de cap. para el amasado  
1,2 kg mixer capacity



- Regulador de velocidad para 6 velocidades y función PULSE (Turbo).
- Amasado con movimientos planetarios. Doble movimiento de giro, rotatorio y orbital.
- Brazo basculante de 35° para acoplar los distintos accesorios.
- Tapa transparente anti-salpicaduras con ventana para añadir ingredientes durante el uso.

- Régulateur de vitesse pour 6 vitesses et fonction PULSE (Turbo).
- Pétrissage avec des mouvements planétaires. Double mouvement de rotation, rotatoire et orbital.
- Bras pivotant de 35° pour fixer aisément les différents accessoires.
- Couvercle transparent anti-éclaboussures avec fenêtre pour ajouter les ingrédients pendant l'utilisation.

- Geschwindigkeitsregler für 6 Stufen und PULSE (Turbo).
- Planeten-Rührsystem. Doppelte Dreh-, Rotations- und Planetarbewegung.
- Im 35° Winkel schwenkbarer Arm, um die verschiedenen Accessoires einzustecken.
- Durchsichtiger Deckel gegen Spritzer mit Fenster zur Zugabe von Zutaten.

- Speed regulator with 6 speeds and a PULSE (Turbo) function.
- Mixer with planetary motion. Twin twisting, rotational and orbital movement.
- 35° swing arm for connection of different accessories.
- Transparent anti-splatter lid with opening for adding ingredients during use.

- Regulador de velocidade com 6 velocidades e função PULSE (Turbo).
- Movimento de amassar planetário. Duplo movimento de rotação e orbital.
- Braço basculante de 35° para acoplar os diferentes acessórios.
- Tampa transparente, anti-salpicaduras, com janela para acrescentar ingredientes durante a utilização.



## Batidora amasadora GOURMET

Batteur pétrisseur  
Mix- und kneetmaschine  
Mixer-kneader  
Batedeira amassadora

Ref	€	W	L	U.Venta
69388	211,50	600	4,0	1

Ref	Tensión/Voltage	Potencia/Power	Velocidad/Speed	Velocidad/Speed	Capacidad/Cap.	Dimensiones/Sizes	Peso/Weight
69388	220-240 V; 50/60 Hz	600 W	6	60 - 180 r.p.m.	4,0 L	35x22x30 cm	4,40 Kg

### Accesorio jarra

Accessoire cruche  
Krugzubehör  
Jug accessory  
Acessório de jarro



	Ref	€	L	U.Venta	
A	69584	27,20	1,5	1	Para la batidora amasadora DELICY
B	69684	27,20	1,5	1	Para la batidora amasadora COMPLET

### Accesorio picadora/embutidora/kibbe

Accessoire hachoir/stuffer/kibbe  
Fleischwolf/Wurstfüller/Kibbe Zubehör  
Chopper/stuffer/kibbe accessory  
Acessório picador/stuffer /kibbe



Ref	€	L	U.Venta
69685	57,60	1,5	1

### 3 in 1

Tres electrodomésticos en uno · Three appliances in one



Jarra batidora (1,5L)  
Blender jug

Picadora · Embutidos · Kibbe  
Chopper · Sausages · Kibbe

Batidora - amasadora  
Mixer-kneader

- Amasado con movimientos planetarios. Doble movimiento de giro, rotatorio y orbital. Mecanismo de engranajes metálicos.
- Brazo basculante de 35° para acoplar los distintos accesorios.
- Bol de acero inoxidable 18/10 de 5 L (69583) / 6 L (69683) de capacidad.
- Tapa transparente antisalpicaduras con ventana para añadir ingredientes durante el uso.
- 3 accesorios para batir, mezclar y amasar. Recubrimiento antiadherente de los accesorios mezclador y amasador para evitar que los alimentos se peguen.
- Ventosas de sujeción para una perfecta estabilidad.
- Accesorios no incluidos (jarra y picadora) compatibles para conseguir un robot multifuncional.

- Pétrissage avec des mouvements planétaires. Double mouvement de rotation, rotatoire et orbital. Mécanisme d'engrenages métalliques.
- Bras pivotant de 35° pour fixer aisément les différents accessoires.
- Bol en acier inoxydable 18/10 d'une capacité de 5 L (69583) / 6 L (69683).
- Couvercle transparent anti-éclaboussures avec fenêtre pour ajouter les ingrédients pendant l'utilisation.
- 3 accessoires pour battre, mixer et pétrir. Revêtement antiadhésif de l'accessoire pour mélanger et pétrir afin d'éviter que les aliments collent.
- Ventouses de fixation pour une bonne stabilité.
- Accessoires non inclus (bol et hachoir) compatibles pour obtenir un robot multifonctions.

- Mixer with planetary motion. Twin twisting, rotational and orbital movement. Mechanism of metal gears.
- 35° swing arm for connection of different accessories.
- 18/10 stainless steel bowl with 5 L (69583) / 6 L (69683) capacity.
- Transparent anti-splatter lid with opening for adding ingredients during use.
- 3 accessories for whisking, mixing and kneading. Non-stick coating on the mixer and kneading accessories to prevent food from sticking.
- Suction pads for good stability.
- Non included accessories (jug and mincer) can be added to create a multifunctional kitchen robot.



Velocidades  
**5+PULSE**  
Speeds



Velocidades  
**6+PULSE**  
Speeds



### Batidora amasadora DELICY

Batteur pétrisseur  
Mix- und Knetmaschine  
Mixer-kneader  
Batedeira amasadora

Ref	€	W	L	U.Venta
69583	354,80	1000	5,0	1

### Batidora amasadora COMPLET

Batteur pétrisseur  
Mix- und Knetmaschine  
Mixer-kneader  
Batedeira amasadora

Ref	€	W	L	U.Venta
69683	382,10	1500	6,0	1

Ref	Tensión/Voltage	Potencia Power	Velocidades Speeds	Veloc. Amasadora Kneading speed	Velocidad jarra Jug speed	Veloc. picadora Mincer speed	Capacidad Capacity	Dimensiones/Sizes	Peso/Weight
69583	220-240 V; 50/60 Hz	1000 W	5	128 - 540 r.p.m.	3.200 - 13.500 r.p.m.	41 -172 r.p.m.	5,0 L	32,5x25x36,5 cm	6,35Kg
69683	220-240 V; 50/60 Hz	1500 W	6	117 - 606 r.p.m.	2.600 - 13.500 r.p.m.	37 - 195 r.p.m.	6,0 L	40x25,5x33,5 cm	7,00 Kg



**Tapa transparente antisalpicaduras extraíble**

Removable non-spatter transparent lid

**Bol giratorio**  
Rotating bowl



- Regulador de velocidad para 5 velocidades y función PULSE (Turbo).
- Amasado con doble movimiento de giro, rotatorio y orbital.
- Brazo basculante de 40° para acoplar los distintos accesorios.
- Sistema de bloqueo de seguridad y protección.
- Bol de acero inoxidable 18/10 de 3,5L de capacidad.
- Tapa transparente anti-salpicaduras extraíble.
- Botón de expulsión para soltar las varillas fácilmente.
- Incluye dos juegos de varillas para batir y amasar de acero inoxidable 18/10.
- Pies de gomas de sujeción para una perfecta estabilidad.
- Soporte de almacenamiento del cable de alimentación.

- Speed regulator with 5 speeds and a PULSE (Turbo) function.
- Mixer with twin twisting, rotational and orbital movement.
- 40° swing arm for connection of different accessories.
- Blocking system for safety and protection.
- 18/10 Stainless steel bowl with 3,5-litre capacity.
- Removable non-spatter transparent lid.
- Remove button to easily release the blades.
- Includes two sets of accessories for blending and kneading in 18/10 Stainless steel.
- Rubber fastener feet for perfect stability.
- Power cable storage support.

### 2 in 1

**Dos electrodomésticos en uno**  
Two appliances in one



**Con dos pasos consigues una batidora de varillas**

With two steps you get a whisk



## Batidora amasadora MULTI

Batteur pétrisseur  
Mix- und Knetmaschine  
Mixer-kneader  
Batedeira amasadora

Ref	€	W	L	U.Venta
69483	113,60	400	3,50	1

Ref	Tensión/Voltage	Potencia/Power	Velocidad/Speed	Velocidad/Speed	Capacidad/Cap.	Dimensiones/Sizes	Peso/Weight
69483	220-240 V; 50/60 Hz	400 W	5 + TURBO	1.200 r.p.m.	3,50 L	33,5x22x34 cm	2,45 Kg

# Batidora BATIDOS · CÓCTELES



**Ideal para elaborar batidos y cócteles**  
Ideal for making smoothies and cocktails

**Interruptor velocidad**  
Speed switch



**Soportes enganche vaso batidor**  
Beater cup attachment brackets

## Batidora

Batteur  
Mixer  
Blender  
Batedeira

Ref	€	U.Venta
69111	282,30	1

Ref	Tensión/Voltage	Potencia/Power	Velocidad/Speed	Capacidad/Capacity	Dimensiones/Sizes	Peso/Weight
69111	220-240 V / 50-60 Hz	400 W	10.000 - 15.000 r.p.m.	0,60 L	21x15x51 cm	6,20 Kg

# Colección BATIDORES DE VARILLAS



· Household use ·



- Ideal para batir, mezclar y amasar fácilmente todo tipo de preparaciones reposteras de manera fácil y eficiente.
- Dispone de 5 velocidades y función TURBO para regular la velocidad.
- Potente, silencioso y ligero para una mayor comodidad durante el uso.
- Empuñadura ergonómica; permite realizar la mezcla de manera segura y firme.
- Incluye 2 varillas batidoras y 2 varillas amasadoras.
- Extrae las varillas fácilmente con el botón de expulsión.

- Idéal pour battre, mélanger et pétrir facilement tout type de préparations pâtisseries de façon facile et efficace.
- Dispose de 5 vitesses et d'une fonction TURBO pour régler la vitesse à tout moment.
- Puissant, silencieux et léger pour une plus grande praticité d'utilisation.
- Manche ergonomique ; qui permet de réaliser le mélange de façon sûre et nette.
- Inclut 2 fouets pour battre et 2 fouets pour pétrir.
- Extraction des fouets facile avec le bouton d'expulsion.

- It's perfect for whipping, mixing and kneading all kinds of confectionery preparations quickly and easily.
- It has 5 speeds and a TURBO function for adjusting the speed at all times.
- It's powerful, quiet and lightweight for greater comfort during use.
- The ergonomic handle lets you do the mixture safely and firmly.
- Two whisks and two kneading paddles included.
- Remove the accessories easily with the eject button.



**Display incorporado; indica la velocidad seleccionada y el tiempo de uso**  
The built-in display shows the selected speed and usage time

Velocidades  
**5+PULSE**  
Speeds



## Batidora de varillas HOME

Batteur à main  
Handmixer  
Hand mixer  
Batedor de mão

Incluye dos juegos de varillas para batir y amasar  
Includes two sets of bars to beat and knead

Ref	€	W	U.Venta
69384	47,10	300	1

Velocidades  
**5+PULSE**  
Speeds



**Varillas amasadoras**  
Dough rods



**Varillas batidoras**  
Beater rods

## Batidora de varillas TitanPro

Batteur à main  
Handmixer  
Hand mixer  
Batedor de mão

Ref	€	W	U.Venta
69374	52,90	350	1

Ref	Tensión/Voltage	Potencia/Power	Velocidad/Speed	Capacidad/Capacity	Dimensiones/Sizes	Peso/Weight
69384	220-240 V; 50/60 Hz	300 W	5 + TURBO	1000 g	18x8x14 cm	1,20 Kg
69374	220-240 V; 50/60 Hz	350 W	5 + TURBO	1000 g	14,5x8,5x19 cm	1,25 Kg

# Batidora Profesional BRISK

Inox  
18/10



· Professional use ·



Rápida · Fast  
Eficiente · Efficient  
Robusta · Robust

- Fabricado en materiales altamente resistentes y de máxima calidad.
- El mango ergonómico ofrece mayor seguridad y control de la batidora.
- Indicado para trabajar en ollas de hasta 10 litros de capacidad.
- Los brazos trituradores, batidores y cuchillas, fabricados en acero inoxidable.
- Colocación y desmontaje sencillo e instantáneo, sin necesidad de utilizar herramientas.
- Prepara purés, cremas y todo tipo de salsas.

- Fabriqué avec des matériaux hautement résistants et d'une qualité maximale.
- Le manche ergonomique offre une sécurité et un contrôle accru du mixeur.
- Indiqué pour travailler dans des marmites de jusqu'à 10 litres de contenance.
- Accessoires pour hacher, mixer, couper, fabriqués en acier inoxydable.
- Installation et démontage simple et instantané, sans utilisation d'outils supplémentaires.
- Permet de préparer des purées, des crèmes et tout type de sauces.

- Aus strapazierfähigen und hochwertigen Materialien hergestellt.
- Ergonomischer Griff für sicheren Halt und Handhabung des Mixers.
- Eignet sich zur Arbeit mit bis zu 10 Liter großen Töpfen.
- Häcksler, Pürierstab und Messer aus Edelstahl.
- Aufsätze lassen sich einfach und schnell ohne Einsatz von Werkzeugen einsetzen und entfernen.
- Zur Bereitung von Pürees, Cremes und alle möglichen Saucen.

- Made from highly resistant materials of the highest quality.
- The ergonomic handle provides greater safety and control of the blender.
- Suitable for working in pots up to 10 litres.
- The shredders, beaters and blades are made of stainless steel.
- Fitting and removing is simple and instant, without using tools.
- Prepare soups, purées and all kinds of sauces.

- Fabricada com materiais altamente resistentes e de máxima qualidade.
- O mango ergonómico oferece maior segurança e controlo da batedeira.
- Indicado para panelas de até 10 litros de capacidade.
- Braço triturador, batedor e lâminas de aço inoxidável.
- Colocação e desmontagem fácil e instantânea, sem necessidade de utilizar ferramentas.
- Prepara purés, cremes e todo o tipo de molhos.



**Regulador de velocidad variable**  
Régulateur de vitesse variable  
Variable speed controller



**Botón de uso continuo**  
Bouton d'utilisation continue  
Continuous use button



**Brazo de fácil desmontaje en acero inoxidable**  
Bras en acier inoxydable facilement démontable  
Easy to remove arm made of stainless steel



**Cuchilla de gran calidad para un óptimo trabajo**  
Lame de grande qualité pour un travail optimal  
High-quality blade for optimum work

## Serie 220

Batidora para uso discontinuo · Mixeur pour une utilisation discontinue · Mixer für diskontinuierliche Verwendung · Blender for discontinuous use  
Batedeira para uso descontinuo

### Velocidad Fija · Fixed Speed



### Velocidad Variable · Variable Speed



Regulador de velocidad variable  
Variable speed controller



### Batidor profesional velocidad fija

Mixer professionnelle vitesse fixe  
Profi- mixer, Festdrehzahl  
Professional immersion blender fixed speed  
Batedeira profissional velocidade fixa

Ref	€	W	U.Venta
69722	230,80	220	1

### Batidor profesional velocidad variable

Mixer professionnelle vitesse variable  
Profi- mixer, variable Geschwindigkeit  
Professional immersion blender variable speed  
Batedeira profissional velocidade variável

Ref	€	W	U.Venta
69723	246,80	220	1

Ref	Tensión/Voltage	Potencia/Power	Velocidad/Speed	Capacidad/Capacity	L.Brazo/Arm length	Peso/Weight
69722	220-240 V; 50/60 Hz	220 W	20.000 r.p.m	10 L	16 cm	1,50 Kg
69723	220-240 V; 50/60 Hz	220 W	4.000 - 20.000 r.p.m	10 L	16 cm	1,50 Kg

## Accesorios

Accessoires · Zubehör · Accessories · Acessórios

### Brazo triturador

Pied mixeur  
Rohr  
Shaft tube  
Pé triturador

Ref	€	L (cm)	U.Venta
69816	117,40	16	1



### Brazo batidor

Fouet mélangeur  
Rührbesen  
Whisk  
Pé amassadora

Ref	€	L (cm)	U.Venta
69815	164,00	18,5	1



Para serie 220 · For 220 series



### Set llaves desmontaje cuchillas

Outil demontage lame set  
Schüsselsatz zum Wechseln der Messer  
Blade disassembly tool set  
Set ferrament desmontagem lâmina

Ref	€	U.Venta
R69722J	10,90	1

Incluye tacos y tornillos para su instalación  
Includes studs and screws for installation

A



B



Inox  
18/10

### Soporte batidora BRISK

Support mélangeur  
Aufhängeleiste für Mixer  
Blender stand  
Suporte para batedeira

	Ref	€	L (cm)	h (cm)	ØVarilla (mm)	U.Venta
A	69801	8,80	7	5,5	5,0	1 Individual
B	69803	16,50	28	5,5	5,0	1 Triple

## Serie 350

Batidora para uso continuo · Mixeur pour une utilisation continue · Mixer für kontinuierlichen Gebrauch · Blender for continuous use  
Batedeira para uso contínuo

### Velocidad Fija · Fixed Speed

#### Batidor profesional velocidad fija

Mixer professionnelle vitesse fixe  
Profi-mixer, Festdrehzahl  
Professional immersion blender fixed speed  
Batedeira profissional velocidade fixa

	Ref	€	Brazo (cm)	U.Venta
<b>A</b>	69761	301,50	20	1
<b>B</b>	69762	314,20	25	1
<b>C</b>	69763	326,80	30	1
<b>D</b>	69764	345,70	40	1
<b>E</b>	69765	370,70	50	1



### Velocidad Variable · Variable Speed



#### Batidor profesional velocidad variable

Mixer professionnelle vitesse variable  
Profi-mixer, variable Geschwindigkeit  
Professional immersion blender variable speed  
Batedeira profissional velocidade variável

	Ref	€	Brazo (cm)	U.Venta
<b>A</b>	69771	318,00	20	1
<b>B</b>	69772	330,60	25	1
<b>C</b>	69773	343,10	30	1
<b>D</b>	69774	361,80	40	1
<b>E</b>	69775	386,90	50	1



Ref	Tensión/Voltage	Potencia/Power	Velocidad/Speed	Capacidad/Capacity	L.Brazo/Arm length	Composición/Comp.	Peso/Weight
69761	220-240 V / 50-60 Hz	350 W	16.000 r.p.m	15 L	20 cm	69735: Motor/Motor 69820: Brazo/Arm	2,95 Kg
69762	220-240 V / 50-60 Hz	350 W	16.000 r.p.m	20 L	25 cm	69735: Motor/Motor 69825: Brazo/Arm	3,00 Kg
69763	220-240 V / 50-60 Hz	350 W	16.000 r.p.m	30 L	30 cm	69735: Motor/Motor 69830: Brazo/Arm	3,80 Kg
69764	220-240 V / 50-60 Hz	350 W	16.000 r.p.m	80 L	40 cm	69735: Motor/Motor 69840: Brazo/Arm	4,00 Kg
69765	220-240 V / 50-60 Hz	350 W	16.000 r.p.m	120 L	50 cm	69735: Motor/Motor 69850: Brazo/Arm	4,20 Kg
69771	220-240 V / 50-60 Hz	350 W	4.000 - 16.000 r.p.m	15 L	20 cm	69736: Motor/Motor 69820: Brazo/Arm	2,95 Kg
69772	220-240 V / 50-60 Hz	350 W	4.000 - 16.000 r.p.m	20 L	25 cm	69736: Motor/Motor 69825: Brazo/Arm	3,00 Kg
69773	220-240 V / 50-60 Hz	350 W	4.000 - 16.000 r.p.m	30 L	30 cm	69736: Motor/Motor 69830: Brazo/Arm	3,80 Kg
69774	220-240 V / 50-60 Hz	350 W	4.000 - 16.000 r.p.m	80 L	40 cm	69736: Motor/Motor 69840: Brazo/Arm	4,00 Kg
69775	220-240 V / 50-60 Hz	350 W	4.000 - 16.000 r.p.m	120 L	50 cm	69736: Motor/Motor 69850: Brazo/Arm	4,20 Kg

Velocidad Fija · Fixed Speed

Velocidad Variable · Variable Speed

## Serie 500

Batidora para uso continuo e intensivo · Mixeur pour une utilisation continue et intensive · Mixer für kontinuierlichen und intensiven Gebrauch  
Blender for continuous and intensive use · Batedeira para uso contínuo e intensivo

### Velocidad Fija · Fixed Speed

#### Batidor profesional velocidad fija

Mixer professionnelle vitesse fixe  
Profi-mixer, Festdrehzahl  
Professional immersion blender fixed speed  
Batedeira profissional velocidade fixa

	Ref	€	Brazo (cm)	U.Venta
<b>A</b>	69781	318,70	20	1
<b>B</b>	69782	331,30	25	1
<b>C</b>	69783	343,90	30	1
<b>D</b>	69784	362,60	40	1
<b>E</b>	69785	387,70	50	1



### Velocidad Variable · Variable Speed



#### Batidor profesional velocidad variable

Mixer professionnelle vitesse variable  
Profi-mixer, variable Geschwindigkeit  
Professional immersion blender variable speed  
Batedeira profissional velocidade variável

	Ref	€	Brazo (cm)	U.Venta
<b>A</b>	69791	333,20	20	1
<b>B</b>	69792	345,80	25	1
<b>C</b>	69793	358,20	30	1
<b>D</b>	69794	377,00	40	1
<b>E</b>	69795	402,10	50	1



Ref	Tensión/Voltage	Potencia/Power	Velocidad/Speed	Capacidad/Capacity	L.Brazo/Arm length	Composición/Comp.	Peso/Weight
69781	220-240 V / 50-60 Hz	500 W	16.000 r.p.m	30 L	20 cm	69750: Motor/Motor 69820: Brazo/Arm	3,55 Kg
69782	220-240 V / 50-60 Hz	500 W	16.000 r.p.m	40 L	25 cm	69750: Motor/Motor 69825: Brazo/Arm	3,60 Kg
69783	220-240 V / 50-60 Hz	500 W	16.000 r.p.m	60 L	30 cm	69750: Motor/Motor 69830: Brazo/Arm	4,40 Kg
69784	220-240 V / 50-60 Hz	500 W	16.000 r.p.m	100 L	40 cm	69750: Motor/Motor 69840: Brazo/Arm	4,60 Kg
69785	220-240 V / 50-60 Hz	500 W	16.000 r.p.m	140 L	50 cm	69750: Motor/Motor 69850: Brazo/Arm	4,80 Kg
69791	220-240 V / 50-60 Hz	500 W	4.000 - 16.000 r.p.m	30 L	20 cm	69751: Motor/Motor 69820: Brazo/Arm	3,55 Kg
69792	220-240 V / 50-60 Hz	500 W	4.000 - 16.000 r.p.m	40 L	25 cm	69751: Motor/Motor 69825: Brazo/Arm	3,60 Kg
69793	220-240 V / 50-60 Hz	500 W	4.000 - 16.000 r.p.m	60 L	30 cm	69751: Motor/Motor 69830: Brazo/Arm	4,40 Kg
69794	220-240 V / 50-60 Hz	500 W	4.000 - 16.000 r.p.m	100 L	40 cm	69751: Motor/Motor 69840: Brazo/Arm	4,60 Kg
69795	220-240 V / 50-60 Hz	500 W	4.000 - 16.000 r.p.m	140 L	50 cm	69751: Motor/Motor 69850: Brazo/Arm	4,80 Kg

Velocidad Fija · Fixed Speed

Velocidad Variable · Variable Speed



## Accesorios

Accessoires · Zubehör · Accessories · Acessórios

### Serie 350



#### Motor batidor profesional SERIE 350

Moteur mixer professionnelle SÉRIE 350  
 Professioneller Mixer Motor, SERIE 350  
 Professional immersion blender motor, SERIE 350  
 Motor bateadeira profissional SÉRIE 350

	Ref	€	W	U.Venta	
A	69735	170,00	350	1	Velocidad Fija · Fixed Speed
B	69736	186,20	350	1	Velocidad Variable · Variable Speed

### Serie 500



#### Motor batidor profesional SERIE 500

Moteur mixer professionnelle SÉRIE 500  
 Professioneller Mixer Motor, SERIE 500  
 Professional immersion blender motor SERIE 500  
 Motor bateadeira profissional SÉRIE 500

	Ref	€	W	U.Venta	
A	69750	186,90	500	1	Velocidad Fija · Fixed Speed
B	69751	201,40	500	1	Velocidad Variable · Variable Speed

### Brazo triturador

Pied mixeur  
 Rohr  
 Shaft tube  
 Pé triturador

	Ref	€	L (cm)	A (cm)	U.Venta
A	69820	131,80	20	12,5	1
B	69825	144,40	25	15,8	1
C	69830	156,80	30	19,2	1
D	69840	175,60	40	25,8	1
E	69850	200,70	50	32,5	1
F	69824	182,00	25	-	1

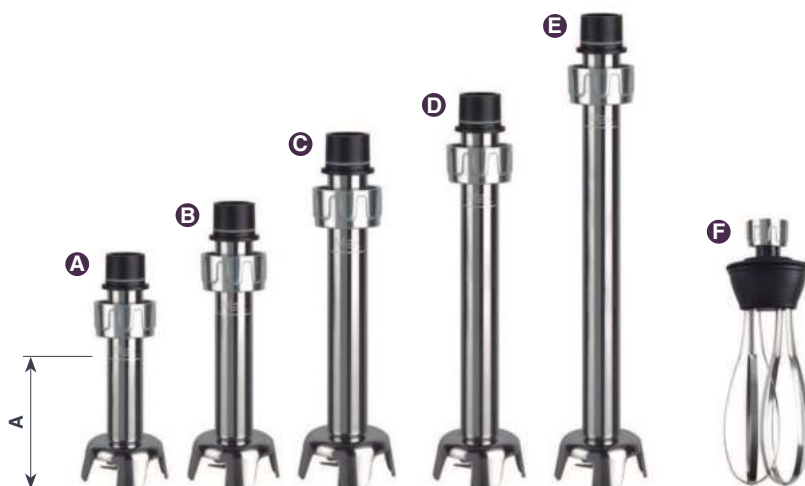

Para serie 350/500 · For 350/500 series



· Incluye tacos y tornillos para su instalación.  
 · Includes studs and screws for installation.



Inox 18/10

### Set llaves desmontaje cuchillas

Outil demontage lame set  
 Schüsselsatz zum Wechseln der Messer  
 Blade disassembly tool set  
 Set ferrament desmontagem lâmina



Ref	€	U.Venta
R69735J	10,90	1

### Soporte batidora BRISK

Support mélangeur  
 Aufhängeleiste für Mixer  
 Blender stand  
 Suporte para bateadeira

	Ref	€	L (cm)	h (cm)	ØVarilla (mm)	U.Venta
A	69801	8,80	7	5,5	5,0	1 Individual
B	69803	16,50	28	5,5	5,0	1 Triple

# Batidora BAMIX



· Professional use ·

**bamix®**



**Incluye soporte pared para colgar**  
Includes wall mount for hanging



**Cuchillas exclusivas de alto rendimiento**  
Exclusive high performance blades



- Permite montar, batir, mezclar, triturar y picar todo tipo de frutas y verduras, así como picar hielo, gracias a sus cuchillas.
- Batidora de precisión y alta calidad.
- Permite trabajar con ella largo tiempo sin que se caliente.
- Mango diseñado para adaptarse a la mano.
- 2 posiciones: I : se utiliza con cantidades pequeñas, para preparados ligeros y esponjosos.
- II: se usa para cantidades más grandes e ingredientes viscosos y consistentes.

- Permet de monter, battre, mélanger, triturer et émincer tout type de fruits et légumes, ainsi que de piler la glace, grâce à ses lames.
- Mélangeur de précision de haute qualité.
- Vous permet de travailler avec lui pendant longtemps sans qu'il chauffe.
- Poignée conçue pour s'adapter à la main.
- 2 postes : I : utilisé en petites quantités, pour des préparations légères et moelleuses.
- II : utilisé pour de plus grandes quantités et des ingrédients visqueux et consistants.

- It enables assembly, beating, mixing, crushing, and chopping of all type of fruits, vegetables, and ice, thanks to its blades.
- High quality precision mixer.
- Allows you to work with it for a long time without it getting hot.
- Handle designed to fit the hand.
- 2 positions: I: used with small amounts, for light and fluffy preparations.
- II: used for larger quantities and viscous and consistent ingredients.

## Batidora BAMIX

Mixer  
Mixer  
Mixer  
Batedeira

Ref	€	U.Venta
61672	330,40	1
61673	516,10	1

Ref	Tensión/Voltage	Potencia/Power	Velocidad/Speed	Inmersión/Inmersion	Altura/Height
61672	220-240 V / 50-60 Hz	200 W	14.000 - 18.000 r.p.m.	25 cm	39,5 cm
61673	220-240 V / 50-60 Hz	350 W	18.000 - 22.000 r.p.m.	35 cm	49,5 cm

## Accesorios

Accessoires · Zubehör · Accessories · Acessórios



### Cuchilla para carne

lame à viande  
Klinge für Fleisch  
Blade for meat  
Lâminar para carne

Ref	€	U.Venta
R61672D	20,20	1



### Grupo pulverizador

Broyeur  
Mahleinheit  
Pulverizing unit  
Conjunto pulverizador

Ref	€	ml	U.Venta
61674	47,30	250	1



### Grupo cortador 5 cuchillas

Combiné râpeur  
Schneide-/Zubereitungseinheit  
Cutting/preparing unit  
Conjunto cortador 5 lâminas

Ref	€	ml	U.Venta
61675	194,20	500	1

# Batidora FAST



· Household use ·



### Cuchillas exclusivas de alto rendimiento

Exclusive high performance blades

## Batidora FAST

Mixeur  
Mixer  
Blender  
Batedeira

Ref	€	W	U.Venta
61681	74,90	700	1

- Permite montar, batir, mezclar, triturar y picar todo tipo de frutas y verduras, así como picar hielo.
- Prepara salsas, batidos, papillas y cremas gracias a sus 4 cuchillas intercambiables (incluye llave para cambiar las cuchillas).
- 2 velocidades: SLOW/TURBO. Profundidad del brazo: 23 cm.
- Incluye un recipiente mezclador de 500, libre de BPA.

- Permet de monter, battre, mélanger, triturer et émincer tout type de fruits et légumes, ainsi que de piler la glace.
- Prépare des sauces, des smoothies, des bouillies et des crèmes grâce à ses 4 lames interchangeables (inclut une clé pour changer les lames).
- 2 vitesses : SLOW/TURBO. Profondeur du bras : 23 cm.
- Inclut un récipient pour mélanger de 500 ml, sans BPA.

- Zum Schlagen, Mischen, Zerkleinern und Zerhacken von Obst und Gemüse aller Art und auch zum Zerhacken von Eis.
- Zum Bereiten von Saucen, Shakes, Babybrei und Cremes, mit 4 austauschbaren Schneidaufsätzen (Schlüssel zum Wechseln inbegriffen).
- 2 Geschwindigkeitsstufen: Slow/Turbo. Länge Mixfuß: 23 cm.
- Inkl. 500 ml großem Mixbehälter, ohne BPA.

- It enables assembly, beating, mixing, crushing, and chopping of all type of fruits, vegetables, and ice.
- Prepare sauces, smoothies, mashes, and creams with its 4 interchangeable blades (includes wrench to change blades).
- 2 speeds: SLOW/TURBO. Arm Depth: 23 cm.
- Includes a mixing container of 500 ml, BPA free.

- Permite montar, bater, misturar, triturar e picar todo o tipo de frutas e verduras, bem como picar gelo.
- Para preparar molhos, batidos, papas e cremes, graças às suas 4 lâminas intercambiáveis (inclui chave para substituir as lâminas).
- 2 velocidades: SLOW/TURBO. Profundidade do braço: 23 cm.
- Inclui um recipiente misturador de 500 ml, sem BPA.



### Cuchillas exclusivas de alto rendimiento

Exclusive high performance blades

## Batidora picadora FAST

Mixeur hacheur  
Mixer und Fleischwolf  
Blender chopper  
Batedeira picadora

Ref	€	W	U.Venta
61671	85,60	700	1

## Picadora

Hachoir  
Fleischwolf  
Mincer  
Picadora

Ref	€	ml	U.Venta
R61671A	12,30	750	1

Incluida en la Ref.: 61671 · Included in Ref.: 61671

## Accesorio

Accessoire · Zubehör · Accessorie · Acessório



Ref	Tensión/Voltage	Potencia/Power	Velocidad/Speed	Capacidad/Capacity	Velocidad/Speed	L.brazo/Shaft leng	Peso/Weight
61681	220-240 V; 50/60 Hz	700 W	9.000 - 16.000 r.p.m.	500 ml (Glass)	SLOW / TURBO	23 cm	1,10 Kg
61671	220-240 V; 50/60 Hz	700 W	9.000 - 16.000 r.p.m.	750 ml (mincer) / 500 ml (Glass)	SLOW / TURBO	23 cm	1,45 Kg

# Batidora PREMIUM



· Household use ·



## Resultados más finos y uniformes

Finer and more even blending

- **PressSystem:** ejerza más o menos presión sobre el botón de regulador de velocidad para aumentar o disminuir la velocidad y obtener la textura deseada. Pulsando el botón hasta el fondo el batidor funcionará a máxima velocidad.
- El nivel de velocidad se verá reflejado en el encendido de los indicadores LED.
- **4 cuchillas de acero inoxidable de máxima calidad:** dos rectas y dos curvas para un rendimiento óptimo y profesional.
- **Cierre bayoneta:** fijación ultrarrápida y sencilla; bloquea y desbloquea el pie con un solo giro garantizando una fijación 100% segura.
- **Fácil limpieza:** vaso apto para el lavavajillas.
- **Compacto y ergonómico:** mango antideslizante.

· **PressSystem:** exercez une pression plus ou moins importante sur le bouton de régulation de vitesse pour augmenter ou réduire la vitesse et obtenir la texture souhaitée. En appuyant à fond sur le bouton, le mixeur fonctionnera à la vitesse maximale.

· Le niveau de vitesse se reflètera sur l'allumage des indicateurs lumineux.

· 4 lames en acier inoxydable de la plus grande qualité : deux droites et deux courbées pour un rendement optimal et professionnel.

· Fermeture à baïonnette : fixation ultra rapide et simple; bloque et débloque le pied d'une seule rotation et garantit une fixation 100% sûre.

· Facile à nettoyer : le bol passe au lave-vaisselle.

· Compact et ergonomique : manche antidérapant.

· **PressSystem:** Apply more or less pressure to the speed regulator button to increase or decrease the speed to get the texture you want. Press the button as far as it goes for maximum speed.

· The speed level is shown by the LED indicator.

· Four top quality stainless steel blades: two straight and two curved blades for optimum professional performance.

· Bayonet latch: the ultra-fast and easy attachment locks and unlocks the blending arm with a simple twist and guarantees a 100% secure hold.

· Easy to clean: the pitcher is dishwasher safe.

· Compact and ergonomic: non-slip handle.



**Botón de bloqueo**  
**Regulador de velocidad**  
Lock button  
Speed regulator button

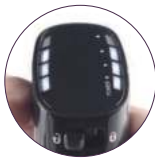

**Indicadores LED de velocidad**  
LED speed indicator light



**Superficie GRIP Technology**  
Surface with GRIP technology



**Fácil montaje/desmontaje**  
Easy assembly/disassembly



**Antisplacaduras**  
Anti-splash housing



**Cuchillas afiladas**  
Sharp blades

## Accesorios

Accessoires · Zubehör · Accessories · Acessórios



### Picadora

Hachoir  
Fleischwolf  
Mincer  
Picadora

Ref	€	ml	U.Venta
R61678K	10,80	500	1

### Batidora PREMIUM

Mixer  
Mixer  
Mixer  
Batedeira

Ref	€	W	U.Venta
61678	63,70	1000	1

### Batidor varillas

Fouet multibrins  
Schneebeesen  
Wire whisk  
Batedeira varetas

Ref	€	L (cm)	U.Venta
R61678L	5,60	23	1



Ref	Tensión/Voltage	Potencia/Power	Velocidad/Speed	Cap. contenedor/Container cap.	Dimensiones/Sizes	Peso/Weight
61678	220-240 V; 50/60 Hz	1000 W	16.000 r.p.m. (max)	800 ml (28 oz)	5,5x6,5x41 cm	0,960 Kg

# Batidora PRO



· Household use ·



## Resultados más finos y uniformes

Finer and more even blending

- **FUNCIÓN SELF-SPEED.** Permite regular la velocidad de giro de la cuchilla.
- 4 cuchillas de acero inoxidable de gran durabilidad: dos rectas y dos curvas para un óptimo rendimiento.
- Pie batidor de 21 cm de longitud y fabricado en acero inoxidable 18/10.
- El sistema de anclaje tipo rosca disminuye las vibraciones durante el uso.
- Incluye vaso mezclador con base antideslizante de 800 ml, marcado en ml/cups y libre de BPA.
- Accesorios aptos para el lavavajillas.

- FONCTION SELF-SPEED. Permet de régler la vitesse de rotation de la lame.
- 4 lames en acier inoxydable d'une grande durabilité : deux droites et deux courbées pour un rendement optimal.
- Pied mixeur de 21 cm de longueur fabriqué en acier inoxydable 18/10.
- Le système d'ancrage de type fileté réduit les vibrations pendant l'utilisation.
- Inclut un verre mélangeur avec une base antidérapante de 800 ml, avec des marques en ml/cups et sans bisphénol A.
- Accessoires aptes pour le lave-vaisselle.

- SELF-SPEED-FUNKTION: Ermöglicht das Drehmoment der Klingen zu regeln.
- 4 Edelstahlklingen: zwei gerade und zwei gekrümmte Klingen sorgen für optimale Ergebnisse.
- Länge des Mix-Sockels: 21 cm. Material: Edelstahl 18/10.
- Die Schraubbefestigung verringert Vibrationen während des Betriebs.
- 800 ml Mixbehälter mit rutschfester Basis und Füllstandsanzeigen in ml/Tassen, BPA-frei.
- Waschmaschinen taugliches Zubehör.

- SELF-SPEED FUNCTION. Enables you to control the speed at which the blade rotates.
- 4 highly durable stainless steel blades: two straight and two curved for optimum performance.
- 21cm blending arm made of 18/10 stainless steel.
- The screw-type attachment system reduces vibrations during use.
- Includes 800ml BPA-free mixing beaker with anti-slip base, marked in ml/cups.
- Dishwasher-safe accessories.

- FUNÇÃO "SELF-SPEED". Permite regular a velocidade de rotação da lâmina.
- 4 lâminas de aço inoxidável, de grande resistência. Duas lâminas retas e duas curvas, para um ótimo rendimento.
- Base da batedeira com 21 cm de comprimento, fabricada em aço inoxidável 18/10.
- O sistema de fixação de tipo rosca reduz as vibrações durante a sua utilização.
- Inclui vaso misturador com base antideslizante de 800 ml, com escala de ml/ cups e livre de BPA.
- Acessórios aptos para a máquina de lavar louça.



**Regulador de velocidad**  
Speed regulator



**TURBO**  
Máxima potencia  
Maximum power



**Fácil montaje / desmontaje**  
Easy assembly / disassembly



**Cuchillas afiladas**  
Sharp blades



**Antisplapicaduras**  
Anti-splash housing



**Mango ergonómico**  
Ergonomic handle

## Accesorios

Accessoires · Zubehör · Accessories · Acessórios



### Picadora

Hachoir  
Fleischwolf  
Mincer  
Picadora

Ref	€	ml	U.Venta
R61682A	12,60	500	1

Incluida en la Ref.: 61683 · Included in Ref.: 61683



### Batidora PRO

Mixer  
Mixer  
Mixer  
Batedeira

	Ref	€	W	U.Venta
<b>A</b>	61682	68,70	1000	1
<b>B</b>	61683	76,80	1000	1

Picadora incluida · Mincer included

### Batidor varillas

Fouet multibrins  
Schneebeesen  
Wire whisk  
Batedeira varetas

Ref	€	L (cm)	U.Venta
R61682B	7,30	20	1



Ref	Tensión/Voltage	Potencia/Power	Velocidad/Speed	Vaso/Glass	Picadora/Mincer	Dimensiones/Sizes	Peso/Weight
61682	220-240 V; 50/60 Hz	1000 W	13.050 - 15.950 r.p.m.	800 ml (28 oz)	-	Ø6,3 x 41,2 cm	0,805 Kg
61683	220-240 V; 50/60 Hz	1000 W	13.050 - 15.950 r.p.m.	800 ml (28 oz)	500 ml	Ø6,3 x 41,2 cm	1,200 Kg

# Batidora MIX

Inox  
18/10



· Household use ·



## Resultados más finos y uniformes

Finer and more even blending

- Dispone de una ruleta de fácil manejo para ajustar la velocidad y obtener la textura deseada.
- 4 cuchillas de acero inoxidable de gran durabilidad: dos rectas y dos curvas para un óptimo rendimiento. Sistema antisalpicaduras.
- Pie batidor de 21 cm de acero inoxidable desmontable de fácil colocación que facilita su almacenamiento y limpieza.
- Incluye un recipiente mezclador de 800 ml (marcado en ml/oz), libre de BPA.
- Vaso apto para el lavavajillas.

- Dispose d'une roulette facile à utiliser pour ajuster la vitesse et obtenir la texture souhaitée.
- 4 lames en acier inoxydable d'une grande durabilité : deux droites et deux courbées pour un rendement optimal. Système anti-éclaboussures.
- Pied mixeur de 21 cm en acier inoxydable démontable facile à installer qui facilite le rangement et le nettoyage.
- Inclut un récipient pour mélanger de 800 ml (avec marques en ml/oz), sans bisphénol A.
- Bol apte pour le lave-vaisselle.

- Benutzerfreundlicher Drehregler zum Einstellen der Drehzahl und zum Erhalt der gewünschten Konsistenz.
- Zwei gerade und zwei gekrümmte Edelstahlklingen sorgen für optimale Ergebnisse.
- 21 cm großer Mixfuß aus Edelstahl lässt sich leicht entfernen und wieder anbringen und ist daher leicht zu reinigen und zu verstauen.
- Inkl. 800 ml großem Mixbehälter (Markierung in ml/oz), ohne BPA.
- Gefäß ist spülmaschinengeeignet.

- It has an easy-to-use wheel to adjust the speed and obtain the desired texture.
- 4 highly durable stainless steel blades: two straight and two curved for optimum performance. Anti-splash system.
- The 21cm stainless steel blender stick is easy to attach and removable for easy storage and cleaning.
- Includes an 800ml BPA-free mixing bowl (marked in ml/oz).
- The glass is dishwasher safe.

- Dispõe uma roleta fácil de utilizar, para ajustar a velocidade e conseguir a textura desejada.
- 4 lâminas de aço inoxidável - duas retas e duas curvas para um rendimento ótimo -, de grande durabilidade. Sistema anti-salpicaduras.
- Acessório batedor de 21 cm, em aço inoxidável, desmontável e de fácil colocação, para facilitar a sua armazenagem e limpeza.
- Inclui um recipiente misturador de 800 ml (ml/oz), livre de BPA.
- Copo apto para a máquina de lavar louça.



**Regulador de velocidad**  
Speed regulator



**TURBO**  
Máxima potencia  
Maximum power



**Fácil montaje/desmontaje**  
Easy assembly / disassembly



**Cuchillas afiladas**  
Sharp blades



**Antisalpicaduras**  
Anti-splash housing



**SOFT TOUCH**  
Mango ergonómico  
Ergonomic handle

## Accesorios

Accessoires · Zubehör · Accessories · Acessórios

### Picadora

Hachoir  
Fleischwolf  
Mincer  
Picadora

Ref	€	ml	U.Venta
R61679AA	12,10	800	1



### Batidor varillas

Fouet multibrins  
Schneebeesen  
Wire whisk  
Batedeira varetas

Ref	€	L (cm)	U.Venta
R61679AB	6,80	23	1



## Batidora MIX

Mixer  
Mixer  
Mixer  
Batedeira

Ref	€	W	U.Venta
61679	60,90	1200	1



Ref	Tensión/Voltage	Potencia/Power	Velocidad/Speed	Cap. contenedor/Container cap.	Dimensiones/Sizes	Peso/Weight
61679	220-240 V; 50/60 Hz	1200 W	13.000 - 15.300 r.p.m.	800 ml (28 oz)	Ø6,5 x 41 cm	0,930 Kg

# Batidora TitanPro



· Household use ·



## Resultados más finos y uniformes

Finer and more even blending

- **Velocidad variable:** dispone de un regulador de velocidad (1 - 5 velocidades) de fácil manejo para ajustar la velocidad y obtener la textura deseada.
- **Función TURBO:** máxima potencia para resultados rápidos, homogéneos e inmejorables.
- **4 cuchillas de acero inoxidable de máxima calidad:** dos rectas y dos curvas para un rendimiento óptimo y profesional.
- **Cierre bayoneta:** fijación ultrarrápida y sencilla; bloquea y desbloquea el pie con un solo giro garantizando una fijación 100% segura.
- **Fácil limpieza:** vaso apto para el lavavajillas.
- **Compacto y ergonómico:** mango antideslizante.

- Vitesse variable : dispose d'un régulateur de vitesse (1 - 5 vitesses) facile à utiliser pour régler la vitesse et obtenir la texture souhaitée.
- Fonction TURBO : puissance maximale pour des résultats rapides, homogènes et uniques.
- 4 lames en acier inoxydable de la plus grande qualité : deux droites et deux courbées pour un rendement optimal et professionnel.
- Fermeture à baïonnette : fixation ultra rapide et simple; bloque et débloque le pied d'une seule rotation et garantit une fixation 100% sûre.
- Facile à nettoyer : le bol passe au lave-vaisselle.
- Compact et ergonomique : manche antidérapant.

- Variable speed: it has an easy to use speed regulator (1 - 5 speeds) for adjusting the speed to get the texture you want.
- TURBO function: maximum power for fast, homogeneous and unbeatable results.
- Four top quality stainless steel blades: two straight and two curved blades for optimum professional performance.
- Bayonet latch: the ultra-fast and easy attachment locks and unlocks the blending arm with a simple twist and guarantees a 100% secure hold.
- Easy to clean: the pitcher is dishwasher safe.
- Compact and ergonomic: non-slip handle.



**Regulador de velocidad**  
Speed regulator



**TURBO**  
Máxima potencia  
Maximum power



**Fácil montaje / desmontaje**  
Easy assembly / disassembly



**Cuchillas afiladas**  
Sharp blades



**Antisplacaduras**  
Anti-splash housing

## Accesorios

Accessoires · Zubehör · Accessories · Acessórios



## Picadora

Hachoir  
Fleischwolf  
Mincer  
Picadora

Ref	€	ml	U.Venta
R61668C	17,00	500	1

Incluida en la Ref.: 61669 · Included in Ref.: 61683



## Batidor varillas

Fouet multibrins  
Schneebeesen  
Wire whisk  
Batedeira varetas

Ref	€	L (cm)	U.Venta
R61668D	8,50	23,5	1



## Batidora TitanPro

Mixer  
Mixer  
Mixer  
Batedeira

	Ref	€	W	U.Venta
<b>A</b>	61668	46,40	600	1
<b>B</b>	61669	59,20	600	1

**Picadora incluida** · Mincer included

Ref	Tensión/Voltage	Potencia/Power	Velocidad/Speed	Vaso/Glass	Picadora/Mincer	Dimensiones/Sizes	Peso/Weight
61668	220-240 V; 50/60 Hz	600 W	15.000 r.p.m.	600 ml	-	8,5 x6,28x39,7 cm	0,845 Kg
61669	220-240 V; 50/60 Hz	600 W	15.000 r.p.m.	600 ml	500 ml	8,5 x6,28x39,7 cm	1,085 Kg

# Picadora profesional QUICK

new

Inox  
18/10



· Professional use ·



- Picadora profesional que pica y tritura todo tipo de alimentos (verduras, hortalizas, carnes y frutos secos, etc.) de manera rápida y homogénea.
- Contenedor extraíble de acero inoxidable 18/10 de máxima calidad de 3 litros de capacidad.
- Tapa de tritán transparente totalmente extraíble con orificio para añadir ingredientes en marcha. Libre de BPA.
- Cuchillas extraíbles de acero inoxidable totalmente afiladas.
- 100% seguro: evita la puesta en marcha si el contenedor o la tapa no están en la posición adecuada.
- Dispone de protección contra el sobrecalentamiento.
- Encendido y apagado con un solo clic mediante el botón ON / OFF.
- Cubeta inclinada para una fácil introducción y recogida de los alimentos.
- Pies antideslizantes para una máxima estabilidad.
- Fácil limpieza. Contenedor y tapa aptos para el lavavajillas.

- This professional chopper chops and crushes all kinds of food, like vegetables, greens, meat and nuts, quickly and evenly.
- It has a removable top quality 18/10 stainless steel container with a capacity of 3 litres.
- The transparent Tritan lid is completely removable and has a hole for adding ingredients while the chopper is running. It's BPA free.
- The removable stainless steel blades are completely sharpened.
- 100% Safe: prevents starting if the lid or container are not in the right place.
- It has protection against overheating.
- It can be turned on and off with a single click using the ON / OFF button.
- The container is tilted so it's easy to put food in and take it out.
- It has non-slip feet for maximum stability.
- Easy to clean, the lid and container are dishwasher safe.

## Picadora profesional QUICK

Hachoir professionnel  
 Professioneller Zerkleinerer  
 Professional chopper  
 Picadora profesional

Ref	€	W	L	U.Venta
69490	980,80	735	3,0	1

Ref	Tensión/Voltage	Potencia/Power	Velocidad/Speed	Cap. contenedor Container cap.	Cuchillas (Ø) Blades (Ø)	Orif. de entrada Entry hole	Dimensiones/Sizes	Peso/Weight
69490	220-240 V ; 50/60 Hz	735 W	1500 r.p.m.	3,0 L	18,5 cm	5 cm	28,5x32x43 cm	14,20 Kg

# Picadora de cristal QUARTZ

Inox

Cristal  
Glass  
Container



· Household use ·



- Picadora eléctrica compacta que pica todo tipo de alimentos, como verduras, frutas, jengibre, ajo, cebolla, frutos secos y hierbas.
- Cabezal de acero inoxidable y recipiente de cristal de alta calidad.
- Cuchillas ultrarresistentes.
- Gracias a los engranajes metálicos permite un uso continuo.
- Corta con precisión y homogéneamente.
- 2 velocidades; la más veloz para un corte rápido y la más lenta para un corte más controlado.
- Base antideslizante para facilitar la tarea y evitar desplazamientos.
- Fácil de desmontar y limpiar. Contenedor y cuchillas aptos para el lavavajillas.

- Compact electric mincer that processes all kinds of food, such as vegetables, fruit, ginger, garlic, onions, dried fruit and herbs.
- Stainless steel head and high-quality glass container.
- High-strength blades.
- Its metal gears mean it can withstand longer continuous use.
- High-precision, even cutting.
- 2 speeds: fast for rapid cutting and slow for more controlled cutting.
- Non-slip base for easier use with no movement.
- Easy to disassemble for cleaning Dishwasher-proof container and blades.

## Picadora de cristal QUARTZ

Hachoir en verre  
 Fleischwolf, glas  
 Glass mincer  
 Picadora de vidro

Ref	€	W	L	U.Venta
69077	45,40	300	1,2	1
69073	69,80	300	2,0	1



Ref	Tensión/Voltage	Potencia/Power	Nºcuchillas/Blades	Øcuchillas/Blades	Capacidad/Cap.	Dimensiones/Sizes	Peso/Weight
69077	220-240 V ; 50/60 Hz	300 W	4	10,5 cm	1,2 L	18,7x16x25 cm	1,60 Kg
69073	220-240 V ; 50/60 Hz	300 W	4	12,0 cm	2,0 L	21x17,5x27 cm	2,10 Kg



# Picadoras de CARNE



· Professional use ·

Productividad  
**2 kg/min**  
Productivity

- Picadoras estables y resistentes.
  - Engranajes interiores y exteriores metálicos para una mayor resistencia.
  - Incluyen 3 discos perforados de acero inoxidable.
  - Incluyen 4 accesorios extra (Kibbe incluido).
  - Totalmente desmontables para facilitar su limpieza.
- Hachoirs stables et résistants.
  - Engrenages intérieurs et extérieurs métalliques pour une plus grande résistance.
  - Inclut 3 disques perforés en acier inoxydable.
  - Inclut 4 accessoires supplémentaires (kebbeh inclus).
  - Totalement démontable pour faciliter son nettoyage.
- Stabile und beanspruchbare Klinge.
  - Innere und äußere Metallgetriebe für eine höhere Widerstandsfähigkeit.
  - 3 perforierten Edelstahl-scheiben.
  - Dazu gehören 4 Zubehörteile (inkl. Kiebbeh).
  - Für eine einfache Reinigung, komplett auseinandernehmbar.
- Stable and resistant choppers.
  - Interior and exterior metal gear teeth for improved resistance.
  - Includes 3 stainless steel perforated discs.
  - Includes 4 extra accessories (Kibbe included).
  - Can be fully disassembled for easy cleaning.
- Máquinas de picar carne estáveis e resistentes.
  - Engrenagens interiores e exteriores metálicas para uma maior resistência.
  - Inclui 3 discos perfurados de aço inoxidável.
  - Inclui 4 acessórios extras (Kibbe inclusive).
  - Totalmente desmontável para facilitar a sua limpeza.

## Picadora de carne PRO

Hachoir pour viande  
Fleischwolf  
Meat mincer  
Picadora de carne

Cuerpo  
de aluminio fundido  
Molten aluminium body

Ref	€	W	U.Venta
69368	596,30	550	1



**3 discos perforados**  
3 stainless steel perforated discs



**Embutidos (salchichas, chorizo...)**  
Sausages (salchicha, chorizo...)



**Kibbe**  
kibbe

· Semiprofessional use ·



Productividad  
**1 kg/min**  
Productivity

## Picadora de carne

Hachoir pour viande  
Fleischwolf  
Meat mincer  
Picadora de carne

Ref	€	W	U.Venta
69068	234,00	800	1

· Semiprofessional use ·



Productividad  
**1 kg/min**  
Productivity

## Picadora de carne CHOP

Hachoir pour viande  
Fleischwolf  
Meat mincer  
Picadora de carne

Ref	€	W	U.Venta
69369	117,30	300	1

Ref	Tensión/Voltage	Potencia/Power	Par motor/Motor torque	Velocidad/Speed	Capacidad/Capacity	Dimensiones/Sizes	Peso/Weight
69368	220-240 V; 50 Hz	550 W	1,27 Nm	240 r.p.m	2 Kg/min	53,5x26x35 cm	11,0 Kg
69068	220-240 V; 50 Hz	800 W	0,25 Nm		1 Kg/min	35x18x36 cm	5,09 Kg
69369	220-240 V; 50/60 Hz	300 W	0,14 Nm		1 Kg/min	38,6x16,6x34,2 cm	3,70 Kg

# Cortadoras de FIAMBRE

Inox  
18/10



**Alto rendimiento**  
High performance machine

**Transmisión por correa**  
Belt drive

· Professional use ·



**Estructura de aluminio**  
Aluminium frame

## Cortadora de fiambre PROFESIONAL

Trancheuse de charcuterie  
Aufschnittmaschine  
Cold meat cutter  
Cortadora de fiambre

- Cortadora eléctrica de alto rendimiento.
- Corta sin esfuerzo y con una gran precisión.
- Cuchilla desmontable de acero inoxidable de gran calidad.
- Regulador de grosor de corte entre 0 y 11/13 mm.
- Estructura de aluminio, transmisión por correa, pantalla protectora y cabezal ajustable de suave deslizamiento.
- Cuenta con un alador extraíble para ayudar al mantenimiento de la cuchilla.

- Trancheuse électrique à haut rendement.
- Coupe sans efforts et avec une grande précision.
- Lame démontable en acier inoxydable de grande qualité.
- Régulateur d'épaisseur de découpe entre 0 et 11/13 mm.
- Structure en aluminium, transmission par courroie, paroi de protection et tête ajustable à glissement doux.
- Dispose d'un aiguiser extractible pour aider à l'entretien de la lame.

- High performance electric cutter.
- Cuts effortlessly and with high precision.
- High quality removable stainless steel blade.
- Cut thickness regulator between 0 and 11/13 mm.
- Aluminium structure, belt driven, protective screen and adjustable smooth sliding head.
- It has a removable sharpener to help with blade maintenance.

Ref	€	W	U.Venta
69125	660,30	150	1
69130	1.128,00	250	1

Ref	Tensión/Voltage	Potencia/Power	Cuchilla/Blade	Esp. corte/Slice thick.	Dimensiones/Sizes	Peso/Weight
69125	220-240 V; 50/60 Hz	150 W	Ø250 mm / 10"	0 - 11 mm	48x39x36 cm	15,0 Kg
69130	220-240 V; 50/60 Hz	250 W	Ø300 mm / 12"	0 - 13 mm	60x58x44 cm	24,3 Kg

**Bandeja inoxidable abatible**  
Stainless steel tray

**Transmisión por engranaje**  
Gear transmission

· Household use ·

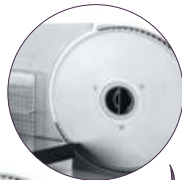

- Cortafiambres eléctrico metálico con acabados en acero inoxidable.
- Cuchilla ultrarresistente y desmontable de acero inoxidable de Ø19 cm con puntas onduladas diseñada para cortar carne, embutido, queso, etc.
- Grosor de corte ajustable de 0 - 15 mm.
- Bandeja inoxidable abatible y de fácil limpieza.
- Pantalla protectora y cabezal ajustable de suave deslizamiento.
- Transmisión por engranaje.
- Muy estable: cuatro ventosas que evitan el deslizamiento en el uso.

- Electric metal meat slicer with a stainless steel finish.
- Ultra strong 19 cm diameter removable stainless steel blade with wavy teeth.
- Designed to cut meat, processed meats, cheese, etc.
- Adjustable cut from 0-15 mm. Easy to clean folding stainless steel tray.
- Protective screen and smooth sliding adjustable head.
- Geared transmission.
- Very stable: four suction cups that prevent sliding during use.



## Cortadora de fiambre HOME

Trancheuse de charcuterie  
Aufschnittmaschine  
Cold meat cutter  
Cortadora de fiambre



**Grosor de corte ajustable de 0 - 15 mm**  
Adjustable cut from 0-15 mm

Ref	€	W	U.Venta
69118	118,10	150	1

Ref	Tensión/Voltage	Potencia/Power	Cuchilla/Blade	Esp. corte/Slice thick.	Dimensiones/Sizes	Peso/Weight
69118	220-240 V; 50/60 Hz	150 W	Ø190 mm / 75"	0 - 15 mm	37,3x27,9x27,5 cm	4,51 Kg

# Cortadora de verduras **PROFESIONAL**



· Professional use ·

## 2 entradas para los diferentes tipos de verduras

2 openings for different types of vegetables



- Cortador de verduras para uso profesional.
- Construida totalmente en aluminio anodizado de alta resistencia.
- Cuerpo superior abatible para facilitar la limpieza, el mantenimiento y la colocación de los discos de corte.
- 2 entradas para los diferentes tipos de verduras; entrada semicircular con palanca para alimentos voluminosos (patatas, tomates, cebollas, etc.) y entrada redonda con empujador para verduras y hortalizas más pequeñas (pepinos, calabacín, zanahorias, etc.).
- Incluye 5 cuchillas: dos discos de corte (2 y 4 mm) y tres discos para rallar (3, 5 y 7 mm).
- Funcionamiento continuo. Transmisión por correa.
- 2 sistemas de seguridad: tornillo de bloqueo de tapa y un sensor electromagnético (al abrir la tapa se apaga la máquina).
- 4 patas de goma para una mejor estabilidad.

- Coupe-légumes à usage professionnel.
- Entièrement fabriqué en aluminium anodisé d'une grande résistance.
- Corps supérieur rabattable pour faciliter le nettoyage, l'entretien et l'installation des disques de coupe.
- 2 entrées pour les différents types de légumes : entrée semi-circulaire avec levier pour aliments volumineux (pommes de terre, tomates, oignons, etc.) et entrée ronde avec poussoir pour légumes classiques et plus petits (concombres, courgettes, carottes, etc.).
- Inclut 5 lames : deux disques pour couper (2 et 4 mm) et trois disques pour râper (3, 5 et 7 mm).
- Fonctionnement continu. Transmission par courroie.
- 2 systèmes de sécurité : une vis de blocage du couvercle et un capteur électromagnétique (l'appareil s'arrête lors de l'ouverture du couvercle).
- 4 pieds en caoutchouc pour une meilleure stabilité.

- Professioneller Gemüseschneider.
- Konstruktion aus 100 % hochfestem eloxiertem Aluminium.
- Klappbares Oberteil für einfache Reinigung, Pflege und Einsatz der Schneidescheiben.
- 2 Öffnungen für unterschiedliche Gemüsearten: halbkreisförmige Öffnung mit Hebel für größere Stücke (Kartoffeln, Tomaten, Zwiebeln usw.) und runde Öffnung mit Stößel für kleinere Stücke (Gurken, Zucchini, Möhren usw.).
- Beinhaltet 5 Schneiden: zwei Schneidescheibe (2 und 4 mm) und drei Reibescheiben (3, 5 und 7 mm).
- Kontinuierlicher Betrieb. Riemenantrieb.
- 2 Schutzsysteme: Fixierschraube für den Deckel und ein elektromagnetischer Sensor (beim Öffnen des Deckels schaltet sich das Gerät ab).
- 4 Gummifüße für festeren Stand.

Producción  
100-300 kg/h  
Production



- Vegetable slicer for professional use.
- Manufactured entirely in high strength anodized aluminium.
- Removable upper body for easy cleaning, maintenance, and placement of slicing discs.
- 2 openings for different types of vegetables; semicircular opening with lever for larger foods (potatoes, tomatoes, onions, etc.) and round opening with pusher for smaller vegetables (cucumbers, zucchini, carrots, etc.).
- Includes 5 blades: two slicing discs (2 and 4 mm) and three grating discs (3, 5 and 7 mm).
- Continuous operation Belt drive.
- 2 safety systems: cover locking screw and an electromagnetic sensor (when the cover is opened the machine turns off).
- 4 rubber bases for improved stability.

- Cortador de verduras para uso profissional.
- Fabricado totalmente em alumínio anodizado de alta resistência.
- Corpo superior rebatível, para facilitar a limpeza, a manutenção e a colocação dos discos de corte.
- 2 entradas para os diferentes tipos de verduras; uma entrada semicircular com alavanca para alimentos volumosos (batatas, tomates, cebolas, etc.) e uma entrada redonda com empurrador para verduras e hortaliças mais pequenas (pepinos, curgetes, cenouras, etc.).
- Inclui 5 lâminas: dois discos de corte (2 e 4 mm) e três discos para ralar (3, 5 e 7 mm).
- Funcionamento contínuo. Transmissão por correia.
- 2 sistemas de segurança: parafuso de bloqueio da tampa e um sensor eletromagnético (ao abrir a tampa a máquina desliga-se)
- 4 patas de borracha para maior estabilidade.

## Cortadora de vegetales **PROFESIONAL**

Coupe-légumes PROFESSIONNEL  
PROFESSIONELLER Gemüseschneider  
PROFESSIONAL vegetable slicer  
Cortadora de verduras PROFESIONAL

Ref	€	W	U.Venta
69500	1.386,30	550	1

Ref	Tensión/Voltage	Potencia/Power	Nºdiscos/Discs	Veloc. discos Discs speed	Orif. redondo Round hole size	Orif. semicircular Semicircular hole	Dimensiones/Sizes	Peso/Weight
69500	220-240 V ; 50 Hz	550 W	5	270 r.p.m.	Ø 6 cm	17x7,5 cm	57x23x51 cm	22,5 Kg

## Accesorios

Accessoires · Zubehör · Accessories · Acessórios

### Disco rallador

Disque à râper  
Reibe Scheibe  
Grater disc  
Disco de ralador



	Ref	€	mm	U.Venta
<b>A</b>	69503	46,20	3	1
<b>B</b>	69505	46,20	5	1
<b>C</b>	69507	46,20	7	1

### Disco cortador

Disque de coupe  
Schneidscheibe  
Cutter disc  
Disco de corte



	Ref	€	mm	U.Venta
<b>A</b>	69512	46,20	2	1
<b>B</b>	69514	46,20	4	1

### Discos opcionales (NO incluidos)

Disques en option (NON inclus) · Optionale Discs (NICHT im Lieferumfang enthalten) · Optional diss (NOT included) · Discos opcionais (NÃO incluídos)

### Disco cortador

Disque de coupe  
Schneidscheibe  
Cutter disc  
Disco de corte

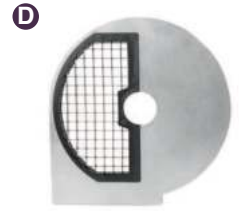

	Ref	€	mm	U.Venta
<b>A</b>	69518	92,20	8	1
<b>B</b>	69510	92,20	10	1
<b>C</b>	69504	107,10	10	1
<b>D</b>	69506	125,30	10x10	1

## Cortador de KEBAB

Inox



· Professional use ·



**Incluye un destornillador para desmontar la cuchilla y una práctica piedra afiladora**  
Screwdriver for removing the blade and a practical sharpening stone included

**Regulador del grosor de corte (ajustable de 0 a 8 mm)**  
Adjustable slicing thickness (from 0 to 8 mm)

**Potente, silencioso e higiénico**  
**Corta sin esfuerzo y con una gran precisión**  
Powerful, quiet and clean  
Effortless and high precision cutting

**Incluye dos cuchillas**  
**LISA y DENTADA**  
Includes two blades  
SMOOTH and SERRATED

### Cortador de kebab

Couteau à kebab  
Kebab-Schneider  
Kebab cutter  
Cortador de kebab

Ref	€	W	U.Venta
69230	194,80	80	1



Ref	Tensión/Voltage	Potencia/Power	Velocidad/Speed	Cuchilla/Blade	Esp. corte./Thickness	Dimensiones/Sizes	Peso/Weight
69230	220-240 V; 50/60 Hz	80 W	2.800 r.p.m.	Ø100 mm	0 - 8 mm	19,9x11,4x18,4 cm	1,20 Kg

# Procesador de ALIMENTOS

Inox  
18/10



· Household use ·



- Múltiples funciones; pica, ralla, mezcla, bate, monta y tritura.
- Rendimiento óptimo y profesional: resultados rápidos, homogéneos e inmejorables.
- Gran capacidad; recipiente transparente graduado y jarra batidora transparentegraduada.
- Infinidad de posibilidades: gracias a sus accesorios de alto rendimiento podrás cocinar sin esfuerzo.
- Tapa y bol con sistema de anclaje de seguridad.
- Diseño atractivo, compacto y muy cómodo para guardar: los accesorios pueden guardarse en el mismo recipiente.
- Fácil de limpiar. Accesorios aptos para el lavavajillas.
- Pies con ventosas para una máxima estabilidad.

- Multifonctions : hache, râpe, malaxe, bat, fouette et triture.
- Des performances optimales et professionnelles : résultats rapides, homogènes et imbattables.
- Une grande capacité : récipient transparent gradué et bol mixeur transparent gradué.
- Des possibilités infinies : grâce à accessoires performants, vous pourrez cuisiner sans effort tout ce que vous voulez.
- Couvercle et bol avec système d'ancrage de sécurité.
- Design attrayant, compact et très pratique à ranger : les accessoires peuvent être stockés dans le même récipient.
- Facile à nettoyer. Accessoires lavables au lave-vaisselle.
- Pieds à ventouses pour une stabilité maximale.

- Multiple functions: It minces, grates, mixes, blends, whips and grinds.
- Optimum and professional performance: fast, homogeneous and unbeatable results.
- High capacity: graduated transparent container and a graduated transparent blender pitcher.
- Limitless possibilities: thanks to high performance accessories you can cook anything you wish effortlessly.
- The lid and bowl have a safety latch system.
- The attractive, compact and very comfortable design lets you keep the accessories right in the container.
- Easy to clean: the accessories are dishwasher safe.
- The feet have suction cups for maximum stability.



**Corte con cuchilla**  
Cutting with blades



**Exprimidor**  
Citrus press



**Conjunto Cuchillas**  
**Mezclador-amasador**  
**Batidor**  
Set Blades  
Mixer-kneader · Whisk



**Jarra batidora**  
Blender jug

new

8  
Accesorios  
Accessories



## Procesador de alimentos multiGenius

Robot multifonction  
Küchenmaschine  
Food processor  
Procesador de alimentos

Ref	€	W	U.Venta
69579	132,00	800	1

Ref	Tensión/Voltage	Potencia Power	Velocidades Speeds	Capacidad Capacity	Dimensiones jarra Jar sizes	Dimensiones jarra bat. Blender jar sizes	Peso jarra Jar weight	Peso jarra bat. Blender jar weight	Peso Weight
69579	220-240 V; 50/60 Hz	800 W	2 + PULSE	2,0 L - Jarra 1,5 L - Batidor 30 ml - Vaso medidor	26x24x42,5 cm	23x24x43,5 cm	2,70 Kg	2,47 Kg	3,80 Kg



Jarra batidora  
Blender jug



Conj. batidor/montador  
Blending/whipping unit



Molinillo + Tapa  
Grinder + Lid



Discos corte  
Cutting discs



Conj. exprimidor  
Juicer attachment



Cortador mini  
Mini cutter



Conj. licuadora  
Smoothie unit



Corte con cuchilla  
Cutting with blades

Disfruta de una experiencia única en la cocina  
Enjoy a unique experience in the kitchen



8 funciones en 1  
8 functions in 1

### Robot multifunción

Robot multifuncions  
Multifunktions-Roboter  
Multifunction robot  
Robô multifuncionais

Ref	€	W	U.Venta
69079	184,30	800	1

Ref	Tensión/Voltage	Potencia/Power	Velocidades/Speeds	Capacidad/Capacity	Dimensiones/Sizes	Peso/Weight
69079	220-240 V; 50 Hz	800 W	10	1,50 L	24x22x40 cm	6,50 Kg



Helados 100% naturales, saludables y bajo en calorías con fruta natural congelada  
100% natural ice creams, healthy and low-calorie ice creams with frozen natural fruit



5 cortes con 5 colores para tus vegetales, frutas, quesos, nueces y chocolate  
5 cuts and 5 colours for your vegetables, fruit, cheeses, walnuts and chocolate

Accesorio para helado de frutas  
Fruit ice cream accessory

5 cuchillas de colores  
5 colored blades



2 en 1  
2 in 1

### Corta vegetales + máquina de helado COSMO

Hachoir légumes + machine à fruitcreme glacee  
Gemüseschneider + Obst-Eis machine  
Vegetables cutter + ice fruit machine  
Corta vegetales + máquina de gelado de fruta

Ref	€	W	U.Venta
69115	80,30	150	1

Ref	Tensión/Voltage	Potencia/Power	Cuchillas/Blades	Dimensiones/Sizes	Peso/Weight
69115	220-240 V; 50/60 Hz	150 W	6	24,5x22,5x19,5 cm	1,89 Kg

# Deshidratadores de ALIMENTOS



· Professional use ·



- Una forma natural y sencilla de conservar frutas, verduras, setas, carnes, pescados, etc. con todos sus nutrientes durante más tiempo.
- Extrae el agua, impidiendo su descomposición por microorganismos, conservándolos sin perder sus valores.
- Calentamiento, el aire circula por su interior de manera uniforme, penetrando por los orificios de las bandejas.
- Accesorio adicional para deshidratar salsas y realizar galletas.
- Une façon naturelle et simple de conserver les fruits, les légumes, les champignons, les viandes, les poissons, etc. en gardant tous leurs nutriments pendant plus longtemps.
- Extrait l'eau, empêchant ainsi leur décomposition due à des microorganismes, en les conservant sans perdre leurs valeurs.
- Chauffe, l'air circule uniformément, en pénétrant par les orifices des plateaux.
- Accessoire supplémentaire pour déshydrater des sauces et réaliser des biscuits.
- Obst, Gemüse, Pilze, Fisch, Fleisch usw. kann so auf einfache und natürliche Weise haltbar gemacht werden Nahrungsmittel.
- Temperatur kann bis auf 70°C geregelt werden.
- Rundum-Beheizung: Gleichmäßige Hitzeverteilung durch selbstdrehende Aufsätze mit luftdurchlässigen Böden.
- Zubehör zur Trocknung von Saucen und Bereitung von Keksen.
- A natural and easy way to preserve fruits, vegetables, mushrooms, meats, fish, etc. with all their nutrients for more time.
- Extracts water from foods, preventing spoilage due to microorganisms and preserving them without losing their values.
- Heating, the air circulates evenly through its interior, penetrating through the holes in the trays.
- Additional accessory for dehydrating sauces and making biscuits.
- Uma forma simples e natural de conservar frutas, verduras, cogumelos, carnes, peixes, etc., com todos os nutrientes durante mais tempo.
- Extrai a água dos alimentos, impedindo assim a sua decomposição devido aos microorganismos, e conservando-os sem que percam as suas qualidades.
- Aquecimento, o ar circula no seu interior de maneira uniforme, penetrando nos orifícios das bandejas.
- Acessório adicional para desidratar molhos e elaborar bolachas.

## Deshidratador de alimentos PRO

Déshydrateur des aliments  
Obsttrockner, elektrisch  
Food dehydrator  
Desidratador de alimentos

Ref	€	W	U.Venta
69523	203,90	800	1



Tiempo recomendado  
**35 h**  
(max)  
Recommended time

6 bandejas desmontables  
6 removable trays

Ref	Tensión/Voltage	Potencia/Power	Temperatura/Temp.	Capacidad/Capacity	Dimensiones/Sizes	Peso/Weight
69523	220-240 V; 50/60 Hz	800 W	29°C - 73°C (máx)	6 bandejas / Trays	36x47x26 cm	5,50 Kg

Accesorio · Accessoire · Zubehör · Accessory · Acessório



Fibra de vidrio  
Fibreglass



## Láminas antiadherentes

Feuilles antiadhésif  
Antihaf-Blätter  
Non-stick sheets  
Lâminas antiaderentes

Ref	€	cm	unidades	U.Venta
66746	9,80	30x40	3	1

Apto para todas las freidoras de aire · Suitable for all air fryers

- 534 -

- Láminas de fibra de vidrio con recubrimiento antiadherente de gran calidad.
- Ideal para colocar sobre bandejas o parrillas de hornos y deshidratadores.
- Vida útil aproximadamente de 1000 hornados.
- Diseñadas para soportar temperaturas de hasta 250°C.
- Recortable para adaptar a cualquier recipiente.
- Reutilizables, para una correcta conservación se recomienda su lavado a mano. No aptas para lavavajillas.
- Fibreglass sheets with non-stick coating high-quality.
- Ideal for placing on baking trays, oven racks and dehydrators.
- Can be used approximately 1,000 times.
- Designed to withstand temperatures up to 250°C.
- Can be cut to fit any container.
- Reusable; in order to keep the sheets in good condition, we recommend washing by hand. Non-dishwasher safe.



· Semiprofessional use ·

· Household use ·

**5 bandejas desmontables**

5 removable trays

Tiempo recomendado  
**48 h** (max)  
Recommended time



**5 bandejas desmontables**

5 removable trays

Tiempo recomendado  
**35 h** (max)  
Recommended time



**Deshidratador giratorio TERRA**

Déshydrateur tournant  
Drehdehydrator  
Rotating dehydrator  
Desidratador giratório

Ref	€	W	U.Venta
69223	129,50	500	1

**Deshidratador de alimentos WHITE**

Déshydrateur des aliments  
Obsttrockner, elektrisch  
Food dehydrator  
Desidratador de alimentos

Ref	€	W	U.Venta
69123	76,30	250	1

Ref	Tensión/Voltage	Potencia/Power	Temperatura/Temp.	Capacidad/Capacity	Dimensiones/Sizes	Peso/Weight
69223	220-240 V; 50/60 Hz	500 W	70°C (max)	5 bandejas / Trays	Ø33x22 cm	2,80 Kg
69123	220-240 V; 50/60 Hz	250 W	70°C (max)	5 bandejas / Trays (13,5 L)	Ø32x27 cm	2,45 Kg

**Cocedor de vapor ECCO**



· Household use ·

**Una forma muy saludable de cocinar los alimentos**  
A very healthy way of cooking food

**Numeración en bandejas**  
Numbering in trays

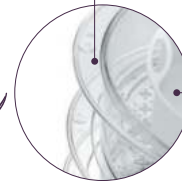

**Cubeta para cocinar arroz**  
Container for cooking rice

**Se pueden preparar varios alimentos simultáneamente**  
You can prepare several foods simultaneously



**Mantiene todos los nutrientes, aromas y sabores de los alimentos**  
Retains all the nutrients, aromas and flavours of food

**Cocedor al vapor ECCO**

Cuiseur vapeur  
Dampfkochgerät  
Steam cooker  
Painela de cocção a vapor

Ref	€	W	U.Venta
69121	92,00	1000	1

Ref	Tensión/Voltage	Potencia/Power	Temperatura/Temp.	Capacidad/Capacity	Dimensiones/Sizes	Peso/Weight
69121	220-240 V; 50/60 Hz	1000 W	100°C (máx)	12 L	41x35x26,57 cm	3,16 Kg



# Freidora INDUCCIÓN

Inox



· Professional use ·



Rejilla  
Rack



Cerrado  
Closed



Abierto  
Open

- Ideal para un uso intensivo en la hostelería y cocinas con grandes cargas de trabajo.
- Potente y eficiente. Capacidad de 8 L.
- Construida totalmente en acero inoxidable (exterior e interior) que garantiza durabilidad y resistencia.
- Gracias al sistema de calentamiento por inducción se consigue una temperatura estable en todo el área, disminuyendo el impacto térmico en el momento de introducir los alimentos.
- Control de temperatura variable de 60°C a 190°C.
- Protección contra el sobrecalentamiento.
- Equipada con grifo de vaciado y elemento de calentamiento oculto para facilitar la limpieza.
- Tapa y cesta incluidas.

- Idéale pour un usage intensif dans l'hôtellerie et dans des cuisines avec de grandes charges de travail.
- Puissante et efficace. Capacité de 8 L.
- Entièrement fabriquée en acier inoxydable (extérieur et intérieur), ce qui garantit durabilité et résistance.
- Le système de chauffe par induction permet d'obtenir une température stable dans tout l'espace, réduisant ainsi l'impact thermique lors de l'introduction des aliments.
- Contrôle de température variable de 60°C à 190°C.
- Protection contre la surchauffe.
- Équipée d'un robinet de vidange et d'un élément de chauffe caché pour faciliter le nettoyage.
- Couvercle et panier inclus.

- Ideal für den intensiven Einsatz in Gastgewerbe und Großküchen.
- Leistungsstark und sparsam im Verbrauch. 8 Liter Fassungsvermögen.
- Langlebige und robuste Edelstahlkonstruktion (innen und außen).
- Induktionstechnologie sorgt für konstante Temperatur auf der gesamten Oberfläche. Hitzeabstrahlung bei der Zugabe von Lebensmitteln ist dadurch geringer.
- Temperatur zwischen 60°C und 190°C einstellbar.
- Schutz vor Überhitzung.
- Mit Ablaufvorrichtung. Heizelement ist außerhalb des Behälters im Gerät integriert, wodurch sich dieses einfach reinigen lässt.
- Abdeckung und Frittierkorb inbegriffen.

- Perfect for heavy use in hotels and restaurants and kitchens with big work loads.
- Powerful and efficient 8 L Capacity.
- Made entirely of stainless steel (inside and outside), which guarantees strength and durability.
- Because of the induction heating system there is a stable temperature in the whole area, which reduces thermal impact when putting the food inside.
- Variable temperature control from 60°C to 190°C.
- Protection against overheating.
- It has a drain tap and a hidden heating element for easy cleaning.
- Lid and basket included.

- Ideal para uso intensivo em hotelaria e em cozinhas com grandes cargas de trabalho.
- Potente e eficiente. 8 litros de capacidade.
- Totalmente fabricada em aço inoxidável (exterior e interior) que garante a sua durabilidade e resistência.
- O seu sistema de aquecimento por indução permite alcançar uma temperatura estável em toda a superfície, reduzindo o impacto térmico no momento de introduzir os alimentos.
- Controlo de temperatura variável de 60°C a 190°C.
- Proteção contra sobreaquecimento.
- Equipada com torneira para esvaziar e resistência de aquecimento oculta, para facilitar a limpeza.
- Tampa e cesto incluídos.



## Freidora de inducción

Friteuse à induction  
Induktionsfritteuse  
Induction fryer  
Fritadeira de indução

Ref	€	W	L	U.Venta
69465	537,40	3500	8	1

Ref	Tensión/Voltage	Potencia Power	Rango temperatura Temperature range	Cestillo Basket	Cap. cestillo Basket cap.	Tanque aceite oil tank	Cap. tanque aceite Oil tank capacity	Dimensiones Sizes	Peso Weight
69465	220-240 V; 50 Hz	3500 W	60°C - 190°C	19x23x14,5 cm	5,5 L	23,8x30x20,5 cm	8 L	29x56,7x41,5 cm	12,6 Kg

# Freidora PROFESIONAL



· Professional use ·



## Especial para todo tipo de frituras

Essential for all types of fried dishes

- Destinada a un uso intensivo en restaurantes, bares, hoteles, etc.
- Especial para todo tipo de frituras, permite freír gran cantidad de alimento.
- Fabricada en acero inoxidable, exterior e interior, garantiza una gran durabilidad y resistencia.
- Termostato de temperatura regulable.
- Termostato de seguridad con rearme manual.
- Mango termorresistente.
- Sistema de fijación de la cesta para escurrir el aceite.
- Indicador máximo-mínimo de nivel de aceite.
- Panel extraíble para facilitar el mantenimiento y la limpieza.

- Destinée à un usage intensif dans les restaurants, les bars, les hôtels, etc.
- Spécial pour tout type de friture, permet de frire de grandes quantités d'aliments.
- Fabriquée en acier inoxydable, extérieur et intérieur, elle garantit une grande durabilité et résistance.
- Thermostat de température réglable.
- Thermostat de sécurité avec réinitialisation manuelle.
- Manche résistant à chaleur.
- Système de fixation du panier pour égoutter l'huile.
- Indicateur maximum-minimum du niveau d'huile.
- Panneau extractible pour faciliter l'entretien et le nettoyage.

- Für die intensive Nutzung in Restaurants, Bars, Hotels usw. konzipiert.
- Für alle Frittierarten geeignet. Design für das Frittieren großer Mengen von Lebensmitteln.
- Innen und außen aus rostfreiem Stahl, um eine lange Haltbarkeit und.
- Beständigkeit zu gewährleisten.
- Thermostat zur Temperaturregelung. Sicherheitsthermostat mit manueller Rücksetzung.
- Wärmebeständiger Griff.
- Korbbefestigungssystem zum Abtropfen des Öls.
- Ölfüllstandsanzeige Max.-Min.
- Entnehmbare Schaltkasten zur Erleichterung der Wartung und Reinigung.

- Intended for heavy-duty use in restaurants, bars, hotels, etc.
- Essential for all types of fried dishes, it can fry a large amount of food.
- Made of stainless steel, exterior and interior, guarantees great durability and resistance.
- Adjustable temperature thermostat.
- Safety thermostat with manual reset.
- Heat resistant handle.
- System for hanging the basket to drain the oil.
- Minimum-maximum oil level indicator.
- Removable panel for easy maintenance and cleaning.

- Destinada a um uso intensivo em restaurantes, bares, hotéis, etc.
- Especial para todo o tipo de fritos, permite fritar uma grande quantidade de alimentos.
- Exterior e interior em aço inoxidável, de grande durabilidade e resistência.
- Termóstato de temperatura regulável.
- Termóstato de segurança com rearme manual.
- Mango termorresistente.
- Sistema de fixação do cesto para escorrer o óleo.
- Indicador máximo/mínimo do nível de óleo.
- Painel extraível para facilitar a manutenção e a limpeza.



**Resistencia**  
Resistance



**Cerrado**  
Closed



**Abierto**  
Open

## Freidora

Friteuse  
Friteuse  
Fryer  
Fritadeira



Ref	€	W	L	U.Venta	
69169	272,40	2500	6,0	1	<b>Simple</b> · Simple
69466	426,30	2500x2	6,0x2	1	<b>Doble</b> · Double



## Freidora con grifo

Friteuse avec robinet  
Friteuse mit Wasserhahn  
Fryer with tap  
Fritadeira com torneira



Ref	€	W	L	U.Venta	
69468	288,90	3250	8,0	1	<b>Simple</b> · Simple
69469	550,80	3250x2	8,0x2	1	<b>Doble</b> · Double

Ref	Tensión/Voltage	Potencia/Power	Temperat./Temp.	Capac./Capacity	Cont./Container	Cestillo/Basket	Dimensiones/Sizes	Peso/Weight
69169	220-240 V; 50/60 Hz	2500 W	50°C - 190°C	6,0 L	32,5 x26,5x15 cm	24x20x10,5 cm	27x41x31 cm	5,50 Kg
69466	220-240 V; 50/60 Hz	2500 W x 2	50°C - 190°C	6,0 L x 2	32,5 x26,5x15 cm	24x20x10,5 cm	55x41x31 cm	10,0 Kg
69468	220-240 V; 50/60 Hz	3250 W	50°C - 190°C	8,0 L	24x30x20 cm	18,5x24x14 cm	27x41x42 cm	7,00 Kg
69469	220-240 V; 50/60 Hz	3250 W x 2	50°C - 190°C	8,0 L x 2	24x30x20 cm	18,5x24x14 cm	55x41x42 cm	14,0 Kg

# Freidora ERGO



· *Semiprofessional use* ·



- Especial para todo tipo de frituras, permite freír gran cantidad de alimentos.
- Termostato de temperatura regulable.
- Termostato de seguridad con rearme manual.
- Mango termorresistente.
- Sistema de fijación de la cesta para escurrir el aceite.
- Indicador máximo-mínimo de nivel de aceite.
- Las paredes exteriores se mantendrán frías en todo momento.

- Spécial pour tout type de friture, permet de frire de grandes quantités d'aliments.
- Thermostat de température réglable.
- Thermostat de sécurité avec réinitialisation manuelle.
- Manche résistant à chaleur.
- Système de fixation du panier pour égoutter l'huile.
- Indicateur maximum-minimum du niveau d'huile.
- Les parois extérieures restent toujours froides.

- Für alle Frittierarten geeignet. Design für das Frittieren großer Mengen von Lebensmitteln.
- Thermostat zur Temperaturregelung.
- Sicherheitsthermostat mit manueller Rücksetzung.
- Wärmebeständiger Griff.
- Korbbefestigungssystem zum Abtropfen des Öls.
- Öfüllstandsanzeige Max.-Min.
- Die Außenwände bleiben jederzeit kalt.

- Essential for all types of fried dishes, it can fry a large amount of food.
- Adjustable temperature thermostat.
- Safety thermostat with manual reset.
- Heat resistant handle.
- System for hanging the basket to drain the oil.
- Minimum-maximum oil level indicator.
- The external walls will be kept cool at all times.

- Especial para todo o tipo de fritos, permite fritar uma grande quantidade de alimentos.
- Termóstato de temperatura regulável.
- Termóstato de segurança com rearme manual.
- Mango termorresistente.
- Sistema de fixação do cesto para escorrer o óleo.
- Indicador máximo/mínimo do nível de óleo.
- As paredes exteriores manter-se-ão frias em todo o momento.

## Freidora

Friteuse  
Friteuse  
Fryer  
Fritadeira

Ref	€	W	L	U.Venta	
69135	113,20	2000	3,50	1	<b>Simple</b> · Simple
69170	226,80	2000x2	3,50x2	1	<b>Doble</b> · Double



**Fabricada en acero inoxidable, garantiza una gran durabilidad y resistencia**  
Made of stainless steel, guarantees great durability and resistance

## Freidora con grifo

Friteuse avec robinet  
Friteuse mit Ablaufhahn  
Fryer with tap  
Fritadeira com torneira

Ref	€	W	L	U.Venta
69134	196,00	2500	4,0	1



Ref	Tensión/Voltage	Potencia/Power	Temperatura/Temp.	Capacidad/Capacity	Dimensiones/Sizes	Peso/Weight
69135	220-240 V; 50/60 Hz	2000 W	190°C	3,50 L	41x22x21 cm	2,70 Kg
69170	220-240 V; 50/60 Hz	4000 W	190°C	3,50 x 2 L	41x39,5x21 cm	6,60 Kg
69134	220-240 V; 50/60 Hz	2500 W	190°C	4,00 L	44,3x24,7x27,5 cm	2,94 Kg

# Freidora de aire DUPLOAIR

new



Incluye **RECETARIO**  
RECIPE BOOK included

· Household use ·



- **Cocina casera y saludable: con una sola cucharada de aceite.**
- **11 programas automáticos preestablecidos: diseñado para freír, hornear, asar, calentar, descongelar y deshidratar.**
- **Gran capacidad: 9 L (dos cestillos extraíbles de 4,5 L de capacidad cada uno).**
- **Cestillo doble: control de tiempo y temperatura independiente. Cocina dos platos distintos al mismo tiempo, manteniendo el aroma y el sabor de cada plato.**
- **SyncFinish: acabado sincronizado. Cocina en ambos cestillos con tiempo y temperatura diferente acabando al mismo tiempo.**
- **Tecnología TotalCook: distribuye el calor de manera uniforme a través del aire caliente.**
- **Pantalla táctil: intuitiva y muy fácil de usar. Temperatura regulable: gracias a su termostato podrás regular la temperatura desde 45°C a 200°C. Tiempo ajustable: 0-60 minutos (función deshidratada hasta 20 horas).**
- **TotalSafe: la carcasa y el asa permanecen frías mientras cocinas.**
- **100% ECO y libre de PFOA.**
- **Potencia: 2400 W.**
- **Incluye un recetario exclusivo y diseñado por Lacor.**

- Cuisine maison et saine : avec une seule cuillerée d'huile.
- 11 programmes automatiques préétablis : Conçus pour frire, obtenir une cuisson au four, rôtir, chauffer, décongeler et déshydrater.
- Grande capacité : 9L (Deux paniers amovibles d'une capacité de 4,5 L chacun).
- Panier double : contrôle du temps et de la température de façon indépendante.
- Cuit deux plats différents en même temps, en conservant l'arôme et le goût de chaque préparation culinaire.
- SyncFinish : fin synchronisée. Cuit dans les deux paniers avec une durée et une température différentes en finissant en même temps.
- Technologie TotalCook : distribue la chaleur de façon uniforme à travers l'air chaud.
- Écran tactile : intuitif et très facile à utiliser. Température réglable : Grâce à son thermostat, la température peut être réglée de 45°C à 200°C. Durée réglable de 0 à 60 minutes (fonction déshydratation jusqu'à 20 heures).
- TotalSafe : la carcasse et la poignée restent froides pendant la cuisson.
- 100% ECO et sans PFOA.
- Puissance : 2400 W.
- Inclut un livre de recettes exclusif et conçu par Lacor.

- Healthy, homemade cooking with just a spoonful of oil.
- 11 pre-set automatic programmes: designed for frying, baking, roasting, heating, defrosting and dehydrating.
- High capacity: 9 L (two removable 4.5 L capacity baskets each).
- Double basket: independent time and temperature control. Cooks two different dishes at the same time, whilst still maintaining the original aroma and flavour of each dish.
- SyncFinish: synchronised finish. Cooks food in both baskets at different time and temperature settings, but finishes cooking at the same time.
- TotalCook Technology: hot air distributes heat evenly for perfect results.
- Touch screen: very practical and easy to use. Adjustable temperature: the thermostat allows you to set the temperature from 45°C to 200°C. Programmable time: 0-60 minutes (dehydration function up to 20 hours).
- TotalSafe: body and handle stay cool while cooking.
- 100% ECO and PFOA free.
- Power: 2400 W.
- Includes an exclusive recipe booklet created by Lacor.

Incluye rejillas  
Includes grids



**Pantalla táctil**  
Touch screen



**Tecnología TotalCook: distribuye el calor de manera uniforme a través del aire caliente a gran velocidad**  
TotalCook Technology: it distributes heat uniformly with high speed hot air.

## Freidora de aire DUPLOAIR

Friteuse airfryer  
Aidfryer Heißluft-Fritteuse  
Air fryer  
Fritedeira de aire



**TotalSafe**  
**Carcasa y asa permanecen frías**  
Casing and handle stay cool

Ref	€	W	U.Venta
69508	212,60	2400	1

Ref	Tensión/Voltage	Potencia Power	Temp. Temp.	Temporizador Timer	Programmes Programmes	Capacidad cestillo Basket capacity	Medidas cestillo Basket sizes	Dimensiones Sizes	Peso Weight
69508	220-240 V; 50/60 Hz	2400 W	45°C - 200°C	1 - 60 min	11	4,5 L (x2)	14,5x21x12,5 cm	41x33,5x31,5 cm	7,50 Kg

# Freidora de aire ECOFRY



· Household use ·



- **Cocina casera y saludable:** diseñada para freír, hornear, asar y calentar sin apenas utilizar aceite.
- **8 programas automáticos preestablecidos** para cocinar todo tipo de recetas de forma rápida y sana: patatas fritas, alitas de pollo, pizza etc.
- Todas las funciones disponen de un tiempo de precalentamiento para conseguir resultados óptimos
- **Tecnología TotalCook:** distribuye el calor de manera uniforme a través del aire caliente a gran velocidad.
- **Gran capacidad:** 5,5 litros (cestillo).
- **Intuitiva y muy fácil de usar:** gracias a la pantalla digital se puede ajustar el tiempo (hasta 60 minutos), la temperatura (de 40°C a 200°C.) y los 8 programas preestablecidos.
- **TotalSafe:** la carcasa y el asa permanecen frías mientras cocinas.
- **Recipiente/Cestillo extraíble con antiadherente 100% libre de PFOA.**
- **Incluye un recetario exclusivo y diseñado por Lacor para los 8 programas en 3 idiomas.**
- **Base antideslizante:** garantiza máxima estabilidad durante el funcionamiento.
- **Fácil limpieza:** accesorios aptos para el lavavajillas.

- Cuisine maison saine : conçue pour la friture, la cuisson au four, le rôtissage et le chauffage sans presque utiliser d'huile.
- 8 programmes automatiques pré-réglés pour cuire rapidement et sainement toutes sortes de recettes : frites, ailes de poulet, pizza, etc.
- Toutes les fonctions ont un temps de préchauffage afin d'obtenir des résultats optimaux.
- Technologie TotalCook : distribue la chaleur de manière homogène à travers l'air chaud à grande vitesse.
- Grande capacité : 5,5 litres (panier).
- Intuitif et très facile à utiliser : grâce à l'affichage numérique, vous pouvez régler le temps (jusqu'à 60 minutes), la température (de 40°C à 200°C) et les 8 programmes prédéfinis.
- TotalSafe : le boîtier et la poignée restent froids pendant la cuisson.
- Récipient/panier amovible avec revêtement antiadhésif sans PFOA.
- Comprend un livret de recettes exclusif conçu par Lacor pour les 8 programmes en 3 langues.
- Base antidérapante : garantit une stabilité maximale pendant l'utilisation.
- Facile à nettoyer : les accessoires peuvent être lavés au lave-vaisselle.

- **Homemade healthy cooking:** it's designed for frying, baking, roasting and heating with hardly any oil.
- It has 8 pre-set automatic programmes for making all kinds of recipes in a fast and healthy way: chips, chicken wings, pizza, etc.
- All the functions have a preheating time to get optimal results.
- **TotalCook Technology:** it distributes heat uniformly with high speed hot air.
- High capacity: 5.5 litres (basket).
- Intuitive and very easy to use: thanks to the digital screen, you can set the time (up to 60 minutes), temperature (from 40°C to 200°C) and use 8 pre-set programmes.
- **TotalSafe:** the body and handle stay cool while you cook.
- The removable non-stick basket/container is 100% PFOA free.
- An exclusive cookbook designed by Lacor for the 8 programmes in 3 languages is included.
- The non-slip base ensures maximum stability during use.
- Easy to clean: the accessories are dishwasher safe.

**8**  
Programas  
Programmes



**Pantalla táctil**  
Touch screen

**Tecnología TotalCook: distribuye el calor de manera uniforme a través del aire caliente a gran velocidad**  
TotalCook Technology: it distributes heat uniformly with high speed hot air.



**TotalSafe**  
**Carcasa y asa permanecen frías**  
Casing and handle stay cool

## Freidora de aire ECOFRY

Friteuse airfryer  
Aidfryer Heißluft-Fritteuse  
Air fryer  
Fritedeira de aire

Ref	€	W	U.Venta
69511	171,00	1700	1

Ref	Tensión/Voltage	Potencia Power	Temp. Temp.	Temporizador Timer	Programas Programmes	Cap./medidas cestillo Basket cap./Sizes	Cap./Medidas cubeta Container cap./Sizes	Dimensiones Sizes	Peso Weight
69511	220-240 V; 50/60 Hz	1700 W	40°C - 200°C	1 - 60 min	8	5,5 L (24x21,5x11,5 cm)	6,5 L (26x23,8x13 cm)	41x30x34,5 cm	5,40 Kg

# Freidora de aire VITALCOOK

new



Incluye **RECETARIO**  
RECIPE BOOK included

· Household use ·



- **Cocina casera y saludable:** diseñada para freír, hornear, asar y calentar sin apenas utilizar aceite.
- **Cocina todo tipo de recetas de forma rápida y sana:** patatas fritas, alitas de pollo, etc. garantizando resultados sorprendentes.
- **Tecnología TotalCook:** distribuye el calor de manera uniforme a través del aire caliente a gran velocidad.
- **Capacidad: 3,0 litros.**
- **Intuitiva y muy fácil de usar:** gracias a la pantalla digital se puede ajustar el tiempo (hasta 60 minutos) y la temperatura (de 40°C a 200°C).
- **TotalSafe:** el asa permanece fría mientras cocinas.
- **Recipiente extraíble con antiadherente 100% libre de PFOA.**
- **Incluye un recetario exclusivo y diseñado por Lacor en 3 idiomas.**
- **Libre de BPA.**
- **Base antideslizante:** garantiza máxima estabilidad durante el funcionamiento.
- **Fácil limpieza.**

- Cuisine saine : conçue pour la friture, la cuisson au four, le rôtissage et le chauffage sans presque utiliser d'huile.
- Cuire rapidement et sainement toutes sortes de recettes : frites, ailes de poulet, etc. garantissant des résultats étonnants.
- Technologie **TotalCook** : distribue la chaleur de manière homogène à travers l'air chaud à grande vitesse.
- Capacité : 3,0 litres.
- Intuitif et très facile à utiliser : grâce à l'affichage numérique, vous pouvez régler le temps (de 1 à 60 minutes) et la température (de 40°C à 200°C).
- **TotalSafe** : la poignée reste froide pendant la cuisson.
- Récipient amovible avec revêtement antiadhésif sans PFOA.
- Comprend un livre de recettes exclusif conçu par Lacor en 3 langues.
- Sans BPA.
- Base antidérapante : garantit une stabilité maximale pendant l'utilisation.
- Facile à nettoyer.

- Homemade healthy cooking: it's designed for frying, baking, roasting and heating with hardly any oil.
- Making all kinds of recipes in a fast and healthy way: chips, chicken wings, etc. with excellent results guaranteed.
- **TotalCook** Technology: It distributes heat uniformly with high speed hot air.
- Capacity: 3.0 litres.
- Intuitive and very easy to use: thanks to the digital screen, you can set the time (up to 60 minutes) and temperature (from 40°C to 200°C).
- **TotalSafe**: the handle stay cool while you cook.
- The removable non-stick container is 100% PFOA free.
- An exclusive cookbook designed by Lacor in 3 languages is included.
- BPA free.
- The non-slip base ensures maximum stability during use.
- Easy to clean.

## Cubeta antiadherente Non-stick container



Incluye rejilla  
Includes grid



## Tecnología TotalCook: Distribuye el calor de manera uniforme a través del aire caliente a gran velocidad

TotalCook Technology: It distributes heat uniformly with high speed hot air.



**TotalSafe**  
Carcasa y asa permanecen frías  
Casing and handle stay cool

## Freidora de aire VITALCOOK

Friteuse airfryer  
Aidfryer Heißluft-Fritteuse  
Air fryer  
Friteadeira de aire

Ref	€	W	U.Venta
69509	107,60	1000	1

Ref	Tensión/Voltage	Potencia Power	Temp. Temp.	Temporizador Timer	Capacidad cubeta Container capacity	Medidas cubeta Container sizes	Dimensiones Sizes	Peso Weight
69509	220-240 V; 50/60 Hz	1000 W	40°C - 200°C	1 - 60 min	3,0 L	Ø19x9 cm	34x25x33 cm	2,97 Kg

# Hornos SOBREMESA

new



· Household use ·



- Hornos eléctricos de sobremesa de convección con carcasa de acero en acabado negro.
- Capacidad de 28/35 litros y potencia máxima de 1650/1850 W.
- Alto rendimiento en un diseño compacto.
- Manejables y funcionales.
- 5 funciones predefinidas y temporizador de 0-120 minutos con señal sonora.
- Temperatura ajustable máx. de 230°C.
- Transfieren el calor a través de 4 resistencias.
- Pared de aislamiento y puerta abatible de doble cristal de alta resistencia.
- Luz interior que permite vigilar el proceso.
- Revestimiento antiadherente interior para una fácil limpieza. 100% libre de PFOA.
- Incluyen: bandeja para hornear, parrilla, pinza para bandeja, rustidor giratorio, mango para el rustidor y bandeja recogemigas.

- Four électrique à convection à poser avec corps en acier en use finition noire.
- Capacité de 28/35 litres et puissance maximale de 1650/1850W.
- Haut rendement dans un design compact.
- Maniable et fonctionnel.
- 5 fonctions prédéfinies et minuteur de 0 à 120 minutes avec signal sonore.
- Température réglable : max. 230°C
- Transfère la chaleur à travers 4 résistances.
- Paroi isolante et porte rabattable à double vitrage hautement résistante.
- Éclairage intérieur qui permet de contrôler la cuisson.
- Revêtement antiadhésif intérieur pour un nettoyage facile. 100% sans PFOA.
- Inclut un plat lèche-frites, une grille, une pince pour le plat lèche-frites, une broche à rôtir tournante, un manche pour la broche et une plaque de four.

## Accesorios

Accessoires · Zubehör · Accessories · Acessórios

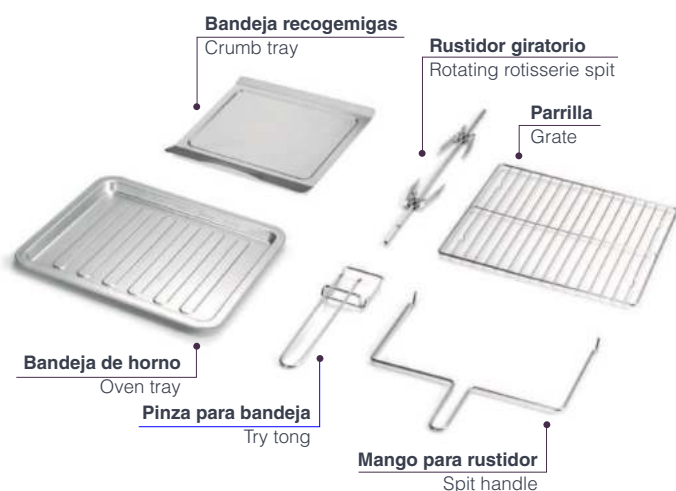

- Electric countertop convection oven with black finish steel use body.
- 28 L/35 L capacity · 1650 W/1850 W max. power.
- High performance in a compact design.
- Highly practical and functional.
- 5 pre-set functions and 0-120 min. timer with audible beep.
- 230°C max. adjustable temperature.
- Transfers heat through 4 heating elements.
- Insulated walls and high-strength, Transfers heat through 4 heating elements.
- Inside light to monitor progress as food cooks.
- Non-stick coating inside for easy cleaning. 100% BPA free.
- Includes baking tray, grill rack, tray tongs, rotating rotisserie spit, spit handle and crumb tray.



## Horno sobremesa

Four à poser  
Tischbackofen  
Countertop oven  
Forno de mesa

	Ref	€	W	L	U.Venta
<b>A</b>	69327	217,90	1650	28	1
<b>B</b>	69347	244,70	1850	35	1

Ref	Tensión/Voltage	Potencia/Power	Capacidad/Capacity	Temporizador/Timer	Temp.	D. int/Int. size	Dimensiones/Sizes	Peso/Weight
69327	220-240 V; 50 Hz	1650 W	28 L	0 - 120 min	70°C - 230°C	34,5x28x20 cm	48x30x40 cm	8,20 Kg
69347	220-240 V; 50 Hz	1850 W	28 L	0 - 120 min	70°C - 230°C	36,5x28,5x23 cm	54x34,5x41 cm	9,75 Kg

# Microondas SOBREMESA

Inox  
18/10



· Household use ·

Panel de control analógico  
Analogue control panel



Plato giratorio de Ø24,5 cm  
Rotating plate Ø24.5 cm

- Plato giratorio, asegura un reparto y un calentamiento uniforme.
- Gran potencia y capacidad interior, calienta en segundos o cocina en minutos.
- Incluye la función descongelar.

- Prato giratório, assegura uma distribuição e um aquecimento uniforme.
- Grand puissance et capacité intérieure, réchauffe en quelques secondes et cuisine en quelques minutes.
- Inclut la fonction décongélation.

- Drehteller, gewährleistet gleichmäßige Erwärmung und Verteilung.
- Große Leistung und Innenkapazität, erwärmt in wenigen Sekunden und kocht in wenigen Minuten.
- Einschließlich Auftaufunktion.

- Turntable ensures even distribution and heating.
- Great power and interior capacity, heats in seconds and cooks in minutes.
- Includes defrost function.

- Prato giratório, assegura uma distribuição e um aquecimento uniforme.
- Grande potência e capacidade interior.
- Aquece em segundos e cozinha em poucos minutos. Inclui a função descongelar.

## Microondas WHITE

Micro-ondes  
Mikrowelle  
Microwave  
Microondas

Ref	€	W	L	U.Venta
69322	157,90	700	20	1

Ref	Tensión/Voltage	Potencia/Power	Grill	Temporizador/Timer	Capacidad/Capacity	Plato/ Plate	D. interiores/Sizes int.	Dimensiones/Sizes	Peso/Weight
69322	220-240 V; 50 Hz	700 W	NO	30 min	20 L	Ø24,5 cm	31,5x29,7x19,8 cm	45,2x33,5x26,2 cm	11,30 Kg

A



B



C



## Horno microondas con plato giratorio + grill COMBI

Four micro-ondes avec plateau tournant + Grill  
Mikrowelle mit Drehteller + Grill  
Microwave oven with turntable + grill  
Microondas com prato giratório + grill

Ref	€	W	L	U.Venta
A 69323	268,20	800	23	1
B 69324	291,90	900	25	1
C 69330	351,40	900	30	1

Ref	Tensión/Voltage	Potencia/Power	Pot. Grill/Grill power	Capacidad/Capacity	Plato/Plateau	D. int/Int. size	Dimensiones/Sizes	Peso/Weight
69323	220-240 V; 50 Hz	800 W	1000 W	23 L	Ø27 cm	33x32x20,5 cm	51x42x28 cm	15,5 Kg
69324	220-240 V; 50 Hz	900 W	1000 W	25 L	Ø31,5 cm	35,5x33x21 cm	51x43x30 cm	14,3 Kg
69330	220-240 V; 50 Hz	900 W	1000 W	30 L	Ø31,5 cm	33x35,5x22,5 cm	52x40x32,5 cm	15,6 Kg



# Microondas PROFESIONAL



· Professional use ·



- Diseñado para uso intensivo, reduciendo el tiempo de calentamiento un 60%.
- Materiales robustos y mayores medidas de seguridad.
- Mayor protección del usuario a radiaciones.
- Base de cerámica plana, sin plato de vidrio.
- Posibilidad de calentar platos grandes.
- Cavity interior de acero inoxidable (más higiénico).
- Calentamiento homogéneo.

- Conçu pour un usage intensif, réduisant le temps de chauffe de 60%.
- Matériaux robustes et mesures de sécurité accrues.
- Protection plus importante de l'utilisateur vis-à-vis des radiations.
- Base en céramique plate, sans plateau en verre.
- Possibilité de chauffer de grandes assiettes.
- Cavité intérieure en acier inoxydable (plus hygiénique).
- Chauffe homogène.

- Designed for intensive use; reduces heating time by 60%.
- Robust materials and greater safety measures.
- Greater protection against heat for the user.
- Flat ceramic base with no glass plate.
- It can heat large dishes.
- Inside cavity made of stainless steel (more hygienic).
- Even heating.

## Horno microondas profesional

Four à micro ondes professionnel  
Mikrowelle Professional  
Professional microwave oven  
Microondas profesional

Ref	€	W	L	U.Venta
69325	628,40	1000	25	1

Ref	Tensión/Voltage	Potencia/Power	Capacidad/Capacity	Dimensiones int./Int. sizes	Dimensiones/Sizes	Peso/Weight
69325	220-240 V / 50 Hz	1000 W	25 L	32x32x19 cm	51x43x31 cm	14,60 Kg

# Placa vitrocerámica ENERGY



· Household use ·

Superficie de calentamiento  
Heating surface



- Placa vitrocerámica rápida, eficaz, segura, fiable y de gran capacidad de calentamiento.
- Su diseño portátil y compacto resulta ideal para su uso en cualquier lugar.
- Área de cocción de 10 cm / 20 cm de diámetro.
- Botones táctiles, intuitivos y fáciles de utilizar con un toque suave.
- Indicadores luminosos.
- Dispone de función de bloqueo de seguridad para niños.
- Regulable en potencia y temperatura.
- Temporizador de 240 minutos con avisador acústico y auto desconexión.

- Plaque vitroceramique rapide, efficace, sûre, fiable et d'une grande capacité de chauffe.
- Sa conception portable et compacte est idéale pour une utilisation n'importe où.
- Zone de cuisson de 10 cm / 20 cm de diamètre.
- Boutons tactiles, intuitifs et faciles à utiliser avec un toucher doux.
- Indicateurs lumineux.
- Dispose d'une fonction de blocage de sécurité pour les enfants.
- Réglable en puissance et en température.
- Minuteur de 240 minutes avec alerte sonore et arrêt automatique.

## Placa vitrocerámica ENERGY

Plaque vitroceramique  
Keramikkochfeld  
Ceramic hob  
Placa vitrocerámica

Ref	€	W	U.Venta
69232	112,30	2000	1

- Fast, efficient, safe, reliable ceramic hob with high heating capacity.
- Its portable and compact design is ideal for use anywhere.
- 10 cm / 20 cm diameter cooking area.
- Intuitive and easy to use soft touch buttons.
- Luminous indicators.
- Includes a child safety lock function.
- Adjustable power and temperature.
- 240-minute timer with audible warning and auto-off.

Ref	Tensión/Voltage	Potencia/Power	Temperatura/Temp.	Temporizador/Timer	Ø cocción/Cooking	Dimensiones/Sizes	Peso/Weight
69232	220-240 V; 50/60 Hz	2000 W (8 levels)	60°C - 600°C (8 levels)	0 - 240 min (8 levels)	10 cm / 20 cm	39x32x5,5 cm	2,60 Kg

# Placas de INDUCCIÓN



· Professional use ·



- Placas de inducción rápidas, eficaces, seguras, fiables y de gran capacidad de calentamiento.
- Sus diseños portátiles y compactos resultan ideales para su uso en cualquier lugar.
- Botones táctiles, intuitivos y fáciles de utilizar con un toque suave.
- Disponen de función de bloqueo de seguridad para niños.
- 40% ahorro de tiempo y energía respecto a otras placas convencionales.

- Plaque à induction rapide, efficace, sûre, fiable et d'une grande capacité de chauffe.
- Sa conception portable et compacte est idéale pour une utilisation n'importe où.
- Boutons tactiles, intuitifs et faciles à utiliser avec un toucher doux.
- Dispose d'une fonction de blocage de sécurité pour les enfants.
- 40% de gain de temps et d'économies d'énergies par rapport à d'autres plaques conventionnelles.

- Schnelles, sicheres, zuverlässiges Induktionskochfeld mit hervorragender Heizleistung.
- Aufgrund seines tragbaren und kompakten Designs ist es überall einsetzbar.
- Intuitive, bedienerfreundliche Soft-Touch-Tastfelder.
- Kindersicherungsfunktion.
- 40 % Zeit- und Energieersparnis verglichen mit anderen herkömmlichen Kochfeldern.

- Fast, efficient, safe, reliable induction hob with high heating capacity.
- Its portable and compact design is ideal for use anywhere.
- Intuitive and easy to use soft touch buttons.
- Includes a child safety lock function.
- 40% saving in time and energy compared to other conventional hobs.

- Placa de indução rápida, eficaz, segura, fiável e de grande potência.
- O seu design portátil e compacto permite a sua utilização em qualquer lugar.
- Botões tácteis, intuitivos e fáceis de utilizar, com um suave toque.
- Função de bloqueio de segurança à prova de crianças.
- Poupança de 40% em tempo e energia, em comparação com as placas convencionais.

Superficie de calentamiento  
Heating surface



Superficie de calentamiento  
Heating surface



## IPX3

proof

### Placa inducción profesional CHEF

Plaque induction professionnelle  
Profi-Induktionsplatte  
Professional induction cooktop  
Placa de indução profissional

Ref	€	W	U.Venta
69132	431,40	3500	1

### Placa inducción profesional ROCA

Plaque induction professionnelle  
Profi-Induktionsplatte  
Professional induction cooktop  
Placa de indução profissional

Ref	€	W	U.Venta
69337	364,70	2700	1

Ref	Tensión/Voltage	Potencia/Power	Niveles Pot. /P. levels	Temperatura/Temp.	Reloj/Timer	Dimensiones/Sizes	Peso/Weight
69132	220-240 V; 50/60 Hz	3500 W	17	35°C - 240°C	0 - 180 min	34x43x12 cm	7,35 Kg
69337	220-240 V; 50/60 Hz	2700 W	10	60°C - 240°C	0 - 180 min	30x39x10 cm	5,40 Kg

**Superficie de calentamiento**  
Heating surface



Ø12 cm  
min  
Ø28 cm  
max

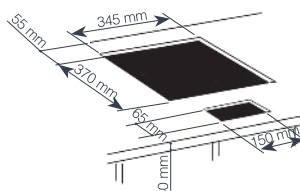

**Posibilidad de encastrar**  
Encastrable option

**Superficie de calentamiento**  
Heating surface

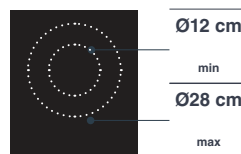

Ø12 cm  
min  
Ø28 cm  
max



**Regulable en potencia**  
Adjustable in power

**Placa inducción profesional EASY**

Plaque induction professionnelle  
Profi-Induktionsplatte  
Professional induction cooktop  
Placa de indução profissional

Ref	€	W	U.Venta
69362	370,10	3500	1

**Placa de inducción PRO**

Table de cuisine à induction  
Induktionskochfeld  
Induction cooker  
Placa de indução

Ref	€	W	U.Venta
69371	333,90	500/3500	1

Ref	Tensión/Voltage	Potencia/Power	Niveles Pot. /P. levels	Niveles Temp. /T. levels	Dimensiones/Sizes	Peso/Weight
69362	220-240 V; 50/60 Hz	3500 W	10 (500W - 800W - 1100W - 1500W - 1800W - 2100W - 2500W - 2800W - 3100W - 3500W)	-	34x44,5x12,5 cm	7,00 Kg
69371	220-240 V; 50/60 Hz	500-3500 W	T-10 (500W (1) - 800W (2) - 1100W (3) - 1500W (4) - 1800W (5) - 2100W (6) - 2500W (7) - 2800W (8) - 3100W (9) - 3500W (10))	10 (80C - 80C - 100C - 120C - 140C - 160C - 180C - 200C - 220C - 240C)	36x38x12,5 cm	6,80 Kg

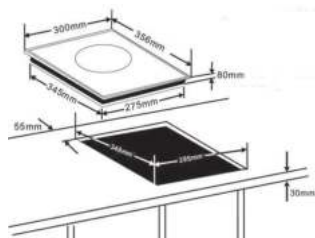

**Posibilidad de encastrar**  
Encastrable option

**Superficie de calentamiento**  
Heating surface



Ø12 cm  
min  
Ø22 cm  
max

**Superficie de calentamiento**  
Heating surface



Ø12 cm  
min  
Ø22 cm  
max



**Placa de inducción EXPERT**

Table de cuisine à induction  
Induktionskochfeld  
Induction cooker  
Placa de indução

Ref	€	W	U.Venta
69032	279,30	2000	1

**Placa de inducción SLIM**

Table de cuisine à Induktion  
Induktionskochfeld  
Induction cooker  
Placa de indução

Ref	€	W	U.Venta
69332	158,40	2000	1

Ref	Tensión/Voltage	Potencia/Power	Niveles Pot. /P. levels	Reloj/Timer	Dimensiones/Sizes	Peso/Weight
69032	220-240 V; 50/60 Hz	2000 W	6	0 - 180 min	31x36x7,5 cm	2,90 Kg
69332	220-240 V; 50/60 Hz	2000 W	8	0 - 180 min	30x37x4,5 cm	2,67 Kg

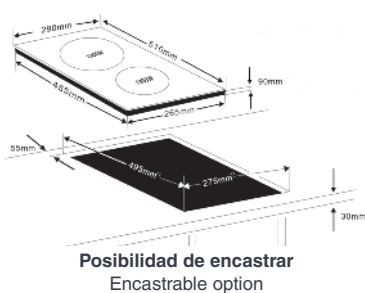

Superficie de calentamiento  
Heating surface



Posibilidad de encastrar  
Encastrable option

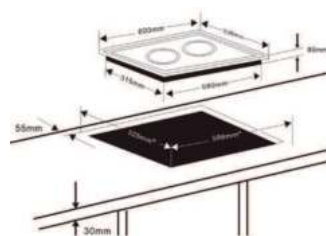

Superficie de calentamiento  
Heating surface



Posibilidad de encastrar  
Encastrable option



### Placa inducción DUAL VERTICAL

Plaque induction double  
Induktionskochfeld doppelt  
Double induction cooktop  
Placa de indução dupla

Ref	€	W	U.Venta
69033	457,20	1800+1300	1

### Placa inducción DUAL HORIZONTAL

Plaque induction  
Induktionskochfeld doppelt  
Induction cooktop  
Placa de indução

Ref	€	W	U.Venta
69333	270,20	2000+1500	1

Ref	Tensión/Voltage	Potencia/Power	Niveles Pot. /P. levels	Reloj/Timer	Dimensiones/Sizes	Peso/Weight
69033	220-240 V; 50/60 Hz	1800 +1300 W	8	0 - 99 min	29x51x9 cm	4,50 Kg
69333	220-240 V; 50/60 Hz	2000 W + 1500 W	7	0 - 180 min	60x34x7,5 cm	5,20 Kg

Placa cerámica: Ø26 cm  
Ceramic plate: Ø26 cm



Inox

### Placa inducción wok Profesional

Plaque à induction wok professionnelle  
Induktionskochplatte wok professional  
Induction cooktop wok professional  
Placa indução wok professional

Ref	€	U.Venta
69138	448,00	1

- Cuerpo fabricado en 3 capas: acero inoxidable 18/10, aluminio, acero inoxidable 18%.
- La capa exterior es de acero inoxidable con componentes ferríticos, lo que la convierte totalmente compatible con las cocinas de inducción.
- Los mango fabricado en acero inoxidable 18/10 y recubierto con un protector térmico de silicona

- Body manufactured in a 3-layered: 18/19 stainless steel, aluminium, 18% stainless steel.
- Exterior layer, of stainless steel with ferrite materials, making it completely compatible with induction cookers.
- The grip are made in 18/10 stainless steel and covered in a silicon heat protection.



### Wok Trimetal

Wok Trimetal  
Wok, Trimetal  
Trimetal wok  
Wok Trimetal

Ref	€	Ø (cm)	L
53836	174,40	36	5,50

Ref	Tensión/Voltage	Potencia/Power	Temperatura/Temp	Tiempo/Timer	Dimensiones/Sizes	Peso/Weight
69138	220-240 V; 50/60 Hz	3500 W	60°C - 240°C	0 - 180 min	34x44,5x12,5 cm	7,50 Kg

# Planchas Grill PROFESIONAL

Inox



· Professional use ·



**Raspar los residuos de los alimentos y el carbón de las planchas**

Used to scrape food and charcoal residue from grills

**Una sola pieza de aluminio fundido**

A single piece of cast aluminium

**Dos puntos de sujeción**

Two hand-holds

**Protector salpicaduras**

Splash guard

**Cuchillas de acero inoxidable intercambiables**

Interchangeable st. steel blades

**AL FU**

Aluminium Fundido/Cast

## Rasqueta profesional para grill

Racloir professionnel pour grill

Professioneller grillschaber

Professional grill scraper

Raspador profesional para grill

Ref	€	cm	L Cuchilla (cm)	U.Venta
67034	70,70	42x15x12	15	1

- Fabricada en acero inoxidable.
- Protector de salpicaduras.
- Placa con superficie lisa de acero laminado y rectificado, calentamiento uniforme.
- Control de temperatura por termostato hasta 300°C.
- Depósito recoge grasas.
- Especialmente indicada para bares, restaurantes, hoteles, etc.
- Para hacer a la plancha carnes, pescados, verduras, hortalizas, crepes, huevos, etc.

- Fabriquée en acier inoxydable.
- Protection contre les éclaboussures.
- Plaque avec surface lisse en acier laminé et rectifié, chauffe uniforme.
- Contrôle de température par thermostat jusqu'à 300°C.
- Réservoir ramasse-graisses.
- Spécialement indiquée pour les bars, restaurants, hôtels, etc.
- Pour faire à la plancha des viandes, poissons, légumes, crêpes, œufs, etc.

- Aus rostfreiem Stahl hergestellt.
- Spritzschutz.
- Ebene Grillplatte aus laminiertem, plangeschliffenem Edelstahl, gleichmäßige Erwärmung.
- Temperaturregelung mit Thermostat bis 300°C.
- Fettaufangbehälter.
- Besonders für Gaststätten, Restaurants, Hotels, usw. geeignet.
- Zum Grillen von Fleisch, Fleisch, Gemüse, Crêpes, Eier usw.

- Made in stainless steel.
- Splash guard.
- Laminated steel, flat surface griddle with uniform heating.
- Thermostat temperature control up to 300°C.
- Oil collector.
- Especially made for bars, restaurants, hotels, etc.
- To cook meat, fish, vegetables, crepes and eggs on the griddle...

- Fabricada em aço inoxidável.
- Inclui protetor contra salpicaduras.
- Placa com superfície lisa de aço laminado e retificado, de aquecimento uniforme.
- Controlo de temperatura por termóstato até 300 °C.
- Depósito para recolha de gorduras.
- Especialmente indicada para bares, restaurantes, hotéis, etc.
- Para grelhar carnes, peixes, verduras, hortaliças, crepes, ovos, etc.

**A**



**B**



## Placa grill PROFESIONAL

Gril Professionnel

Profi-Grill

Professional grill plate

Grelhador Professional

Ref	€	W	Área cocción	U.Venta
<b>A</b> 69379	385,50	3000	40x40 cm	1
<b>B</b> 69179	791,90	6000	61x40 cm	1

Ref	Tensión/Voltage	Potencia/Power	Temperat./Temp.	Zona trabajo/Working zone	Superf. placa/Grill surface	Dimensiones/Sizes	Peso/Weight
69379	220-240 V; 50/60 Hz	3000 W	300°C	1	40x40 cm	41x51x26 cm	27 Kg
69179	220-240 V; 50/60 Hz	6000 W	300°C	2	61x40 cm	61,5x51x26 cm	37 Kg



**Estructura de acero inoxidable**

Stainless steel structure

**Techo móvil**

Mobile roof

- Estructura de acero inoxidable.
- Ideal para calentar, asar, tostar o gratinar directamente los alimentos.
- Placa de calentamiento y techo móvil, ajusta a la posición deseada.

- Structure en acier inoxydable.
- Idéale pour chauffer, rôtir, griller ou gratiner directement les aliments.
- Plaque de chauffe et toit mobile avec réglage de la position souhaitée.

- Struktur aus rostfreiem Stahl.
- Ideal zum direkten Aufwärmen, Braten, Rösten oder Gratinieren von Lebensmitteln.
- Bewegliche Heizplatte und Abdeckung zum Einstellen der gewünschten Position.

- Stainless steel structure.
- Ideal for directly heating, roasting, toasting or browning food.
- Movable heating plate and roof, adjusting the desired position.

- Estrutura de aço inoxidável.
- Ideal para aquecer, assar, tostar ou gratinar diretamente os alimentos.
- Placa de aquecimento e cobertura móvel, ajustável à posição desejada.

## Salamandra PROFESIONAL

Salamandre Professionnelle  
 Professioneller Grill  
 Professional salamander grill  
 Salamandra Profissional

Ref	€	W	U.Venta
69197	1.217,50	4000	1

Ref	Tensión/Voltage	Potencia/Power	Temperatura/Temp.	Plancha/Grill	Dimensiones/Sizes	Peso/Weight
69197	220-240 V; 50/60 Hz	4000 W	50°C - 300°C	59x32 cm	60x45x50 cm	49 Kg

· Household use ·

- Placa de aluminio fundido antiadherente de gran calidad, libre de PFOA.
- Doble zona de cocción para cocinar todo tipo de alimentos:
  - \* Grill: ideal para asar carnes, pescados, marisco, hamburguesas o verduras.
  - \* Lisa: ideal para preparar tortitas, huevos, tostadas o verduras.
- Alcanzan rápidamente la temperatura indicada.
- Garantizan una cocción uniforme por toda la superficie.
- Regulador de temperatura desmontable.
- La ranura central hace que la grasa se deposite en la bandeja recoge-grasas.
- Las asas con recubrimiento aislante de calor proporcionan seguridad.

- High-quality, non-stick, PFOA-free cast aluminium plate.
- Dual cooking area for cooking all kinds of food:
  - \* Grill: ideal for grilling meat, fish, seafood, hamburgers or vegetables.
  - \* Smooth: ideal for making pancakes, eggs, toast or vegetables.
- Quickly reaches the specified temperature.
- Ensures even cooking across the entire surface.
- Detachable temperature controller.
- Fat runs down the central groove and is gathered in the grease tray.
- Handles with heat-insulating coating for added safety.



**Regulador de temperatura**

Temperature controller



**Doble zona de cocción**

Dual cooking area

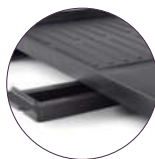

**Bandeja recoge grasas**

Grease tray

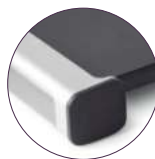

**Asas aislantes de calor**

Heat-insulating handles

**Ranura central recoge-grasas**

Central groove for gathered the grease



**Placa de aluminio fundido**

Cast aluminum plate

## Plancha Grill QUALITY

Plancha & Grill  
 Grillplate  
 Grill plate  
 Prancha & Grelhador

Ref	€	W	U.Venta
69227	84,40	2000	1

Ref	Tensión/Voltage	Potencia/Power	Temperatura/Temp.	Parilla/Grill	Dimensiones/Sizes	Peso/Weight
69227	220-240 V; 50/60 Hz	2000 W	0 - 230°C	52x30 cm	61x32,5x6 cm	3,20 Kg

# Raclette Grill JOIN

new



Household use



- Raclette fabricado con carcasa de acero inoxidable y placa de aluminio fundido con antiadherente de máxima calidad. Libre de PFOA.
- Placa reversible que dispone de una superficie acanalada y otra lisa. Superficie de cocción de 41x20 cm.
- Ajuste de temperatura variable (hasta 210°C) con anillo luminoso.
- Resistencia de 1400W distribuida uniformemente por toda la superficie para un calentamiento rápido y uniforme de los alimentos.
- 8 sartenes individuales con revestimiento esmaltado diferenciados por colores. Libres de PFOA.
- 8 espátulas de madera de haya para remover los alimentos y facilitar el momento de servir.
- Protección contra sobrecalentamiento.
- 100% estable: pies antideslizantes.
- Asas termorresistentes.
- Fácil de limpiar; placa y sartenes extraíbles.



**Apta hasta 8 personas**  
Suitable up to 8 people



**Termostato regulable con anillo luminoso**  
Adjustable thermostat with light ring

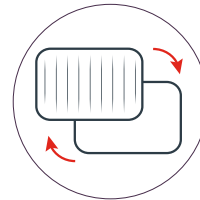

**Plancha y parrilla reversibles. Amplia superficie de cocción de 41x20 cm**  
Reversible flat and grill plate.  
Large baking surface of 41x20 cm

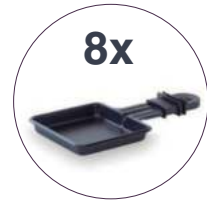

**8 sartenes individuales diferenciados por colores**  
8 individual frying pans differentiated by colors

- Appareil à raclette fabriqué avec carcasse en acier inoxydable et plaque en fonte d'aluminium avec revêtement antiadhésif de la plus grande qualité. Sans PFOA.
- Plaque réversible qui dispose d'une surface cannelée et d'une autre lisse. Surface de cuisson : 41x20 cm.
- Réglage de température variable (jusqu'à 210°C) avec roulette lumineuse.
- Résistance de 1400W distribuée uniformément sur toute la surface pour une chauffe rapide et uniforme des aliments.
- 8 poêlons individuels avec revêtement émaillé différenciés par couleurs. Sans PFOA.
- 8 spatules en bois de hêtre pour remuer les aliments et faciliter au moment de servir.
- Protection contre la surchauffe.
- 100% stable, pieds antidérapants.
- Poignées thermo-résistantes.
- Facile à nettoyer ; plaque et poêlons extractibles.

- Raclette made with a stainless steel body and a cast aluminium top with a maximum quality non-stick coating, PFOA free.
- Reversible top with a channelled surface and a smooth surface, 41x20 cm cooking surface.
- Variable temperature settings (up to 210° C) with a ring that lights up.
- 1400 W heating element distributed evenly over the entire surface so food can be heated quickly and evenly.
- 8 individual enamel coated frying pans in different colours, PFOA free.
- 8 beech wood spatulas for stirring food and serving.
- Overheating protection.
- 100% stable: non-slip feet.
- Heat-resistant handles.
- Easy to clean, removable top and frying pans.



**Incluye 8 prácticas espátulas de madera**  
Including 8 convenient wooden spatulas

## Raclette Grill JOIN

Raclette Grill  
Raclete-Grill  
Grill raclette  
Raclette Grill

Ref	€	W	U.Venta
69348	91,60	1400	1

Ref	Tensión/Voltage	Potencia/Power	Área cocción Cooking area	Área cocción mini sartén Área cocción mini sartén	Dimensiones/Sizes	Peso/Weight
69348	220-240 V; 50/60 Hz	1400 W	41x20 cm	8x8 cm	48x37,5x14,5 cm	2,70 Kg

# Grill ABATIBLES

Inox



· Professional use ·



**Placa superior regulable en altura. Abatible hasta 90°**  
Height adjustable top plate. Folding up to 90°

**Placas onduladas. Placas en hierro colado**  
Corrugated plates. Cast iron plates

**Bandeja recoge grasas**  
Drip tray

**Estructura de acero inoxidable**  
Stainless steel structure



**Mango aislante térmico**  
Thermal insulating handle

**Ideal para preparar carnes, pescados, verduras, bocadillos, etc.**  
Ideal for preparing meat, fish, vegetables, sandwiches, etc.

**Regulador de temperatura**  
Thermostat

## Plancha Grill

Grill  
Grill  
Grill  
Grelhar

	Ref	€	W	U.Venta
<b>A</b>	69166	464,00	2200	1 SIMPLE
<b>B</b>	69167	724,20	4400	1 DOBLE · DOUBLE

Ref	Tensión/Voltage	Tensión/Voltage	Potencia/Power	Temp./Temp.	Temp./Temp.	Dimensiones/Sizes	Peso/Weight
69166	SIMPLE	220-240 V; 50/60 Hz	2200 W	300°C / 572°F (max)	50°C / 122°F (min)	31x31x20 cm	25 Kg
69167	DOBLE · DOUBLE	220-240 V; 50/60 Hz	4400 W	300°C / 572°F (max)	50°C / 122°F (min)	57x31x20 cm	35 Kg



**Abatible a 180°**  
Opens 180°

**Bandeja recoge grasas**  
Drip tray

**Incluye espátula**  
Includes spatula

## Grill abatible PRO

Grill rabattable  
Klappgrill  
Contact grill  
Grelhador rebatível

Ref	€	W	U.Venta
69574	261,60	2000	1

- Grill de gran calidad y robusto para uso profesional.
- Placas extraíbles de aluminio fundido antiadherente de gran calidad, libre de PFOA.
- Doble zona de cocción:
  - \* Grill (27x22 cm): ideal para asar carnes, pescados, marisco, hamburguesas o verduras.
  - \* Lisa (27x22 cm): ideal para preparar tortitas, huevos, tostadas o verduras.
- Alcanza rápidamente la temperatura indicada. Garantiza una cocción uniforme por toda la superficie.
- Regulación en altura. Regulador de potencia y temporizador de 30 minutos.
- Fácil extracción (botón) y colocación de las placas para facilitar su limpieza.
- Bandeja recoge grasas. Base antideslizante.
- Incluye espátula para la limpieza de las placas.

- Robust, high quality grill for commercial use.
- High quality, non-stick, PFOA-free, cast aluminium grill plates.
- Dual cooking area:
  - \* Grill (27x22 cm): ideal for grilling meat, fish, seafood, hamburgers or vegetables.
  - \* Smooth (27x22 cm): ideal for making pancakes, eggs, toast or vegetables.
- Quickly reaches the specified temperature. Ensures even cooking across the entire surface.
- Height-adjustable. 30-minute timer and power regulator.
- Grill plates are easy to remove (button) and replace, making them easy to clean.
- Drip tray. Non-slip base.
- Includes spatula for cleaning the grill plates.



**Regulación en altura**  
Height-adjustable

Ref	Tensión/Voltage	Potencia/Power	Temperatura/Temp.	Temporizador/Timer	Parrilla/Grill	Dimensiones/Sizes	Peso/Weight
69574	220-240 V; 50/60 Hz	2000 W	0 - 230°C	0 - 30 min	27x22 cm	38x35x17 cm	6,0 Kg



# Colección CREPERAS



· Semiprofessional use ·

**Placa de aluminio antiadherente de Ø40 cm**  
Non-stick aluminium plate Ø40 cm



Inox

## Placa crepera

Plaque crêpière  
Crêpes-Kochplatte  
Crepe maker  
Placa crepeira

Ref	€	W	U.Venta
69196	489,20	3000	1

- Crea crepes dulces y salados, pancakes y tortitas de una manera sencilla y cómoda.
- Rapidez, potencia y un calentamiento uniforme.
- Placa de aluminio antiadherente de Ø30 cm, perfecta para hacer crepes de gran tamaño.
- Incluye rastrillo de madera para extender la masa y conseguir un grosor homogéneo y espátula para voltear el crepe.

· Faites des crêpes sucrées et salées, des pancakes et des petites galettes de façon simple et pratique.  
· Rapidité, puissance et une chauffe uniforme.  
· Plaque en aluminium antiadhésive de Ø30 cm, parfaite pour faire de grandes crêpes.  
· Inclut râtelier en bois pour étaler la pâte et obtenir une épaisseur homogène, et une spatule pour retourner la crêpe.

· Süße und salzige Crêpes, Pancakes und Buletten auf einfache und bequeme Weise zubereiten.  
· Schnelligkeit und Leistung bei gleichmäßiger Wärmeverteilung.  
· Anti-Haftbeschichtung aus Aluminium mit Ø30 cm, perfekt für große Crêpes.  
· Inklusive Holzspachtel, um den Teig zu verteilen und eine gleichmäßige Dicke zu erzielen, und Kelle, um die Crêpes zu wenden.

· Make sweet and savoury crêpes, pancakes and pikelets easily and conveniently.  
· Speed, power and uniform heating.  
· Non-stick aluminium plate Ø30 cm, perfect for making large crêpes.  
· Includes a wooden scraper for spreading the batter to achieve uniform thickness and a spatula to flip the crêpe.

· Para fazer crepes doces e salgados, panquecas e tortitas de maneira fácil e cómoda  
· Rapidez, potência e aquecimento uniforme.  
· Placa de alumínio antiaderente de Ø30 cm, ideal para fazer crepes de tamanho grande.  
· Inclui utensílio de madeira para estender a passa e conseguir uma espessura homogénea, e uma espátula para virar os crepes.



**Placa de aluminio antiadherente de Ø30 cm**  
Non-stick aluminium plate Ø30 cm

**Incluye rastrillo y espátula de madera**  
Includes a wooden scraper and spatula



## Crepera

Crêpière  
Crêpesplatte  
Crepe maker  
Crepeira

Ref	€	W	Color	U.Venta
<b>A</b> 69122	55,10	1000	BLACK	1
<b>B</b> 69222	73,80	1000	WHITE	1

**Placa de aluminio antiadherente de Ø30 cm**  
Non-stick aluminium plate Ø30 cm

**Incluye rastrillo y espátula de madera**  
Includes a wooden scraper and spatula



Ref	Tensión/Voltage	Potencia/Power	Temperatura/Temp.	Placa/Grill	Dimensiones/Sizes	Peso/Weight
69196	220-240 V; 50/60 Hz	3000 W	50°C - 250°C	35 cm	45x49x22,5 cm	23 Kg
69122	220-240 V; 50/60 Hz	1000 W	200°C (max)	Ø30 cm	40x36x11 cm	2,12 Kg
69222	220-240 V; 50/60 Hz	1000 W	240 °C (max)	Ø30 cm	40x39x8 cm	1,72 Kg

# Gofrera INOX

Inox  
18/10



· Semiprofessional use ·

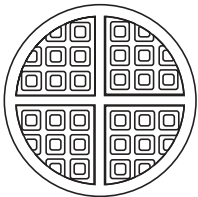

Ø18 cm del gofre  
Waffle Ø18 cm



Placas en hierro colado  
Cast iron plates

Estructura  
de acero inoxidable  
Stainless steel structure

- Fabricada en acero inoxidable de la máxima calidad.
- Placas de calentamiento con recubrimiento antiadherente.
- Rápida de calentar, alcanza fácilmente la temperatura máxima de 300°C.
- Obtendrás gofres crujientes de forma sencilla y rápida.

- Fabriqué en acier inoxydable de la plus grande qualité.
- Plaques de chauffe avec revêtement anti-adhésif.
- Rapide à chauffer, il atteint facilement la température maximale de 300°C.
- Vous obtiendrez des gaufres croustillantes de façon simple et rapide.

- Aus hochwertigem, rostfreiem Stahl hergestellt.
- Heizplatten mit Antihafbeschichtung.
- Schnelle Erhitzung, erreicht schnell die maximale Temperatur von 300 °C.
- Zur schnellen und einfachen Zubereitung von knusprigen Waffeln.

- Made in top quality stainless steel.
- Heating griddle with non-stick coating.
- Fast heating, easily reaching maximum temperatures of 300°C.
- Make crunchy waffles easily and quickly.

- Fabricada em aço inoxidável da melhor qualidade.
- Placas de aquecimento com revestimento antiaderente.
- Aquece rapidamente, alcançando facilmente a temperatura máxima de 300°C.
- Para conseguir gofres estaladiços de forma simples e rápida.



Gofres crujientes de forma  
sencilla y rápida

Crunchy waffles easily and quickly

## Gofrera

Gaufrier  
Wendewaffleisen  
Waffle maker  
Maquina de fazer gofres

Ref	€	W	U.Venta
69349	303,20	1000	1

Ref	Tensión/Voltage	Potencia/Power	Temperat./Temp.	Tiempo/Timer	Placa Gofre/Waffle plate	Dimensiones/Sizes	Peso/Weight
69349	220-240 V; 50/60 Hz	1000 W	50°C - 300°C	5 min	Ø18 cm	26x44x26 cm	7 Kg

# Quemador INOX

Inox  
18/10



· Professional use ·

**Ideal para elaboraciones de cocina y repostería que requieran caramelizar de forma rápida y homogénea (crema catalana, creme brulee, arroz con leche, etc.)**

**Ideal for cooking and pastry making that requires quick and even caramelizing (Catalan cream, creme brulee, rice pudding, etc)**



Mango de plástico  
Plastic handle

Fabricado en acero inoxidable  
Made of stainless steel

Incluye soporte  
Includes support

## Quemador redondo

Fer à caraméliser rond  
Brenner, rund  
Round caramelizer  
Queimador redondo

Ref	€	W	U.Venta
68651	114,70	650	1
68652	132,40	1000	1

Deja una fina capa dorada y crujiente  
It leaves a thin golden and crunchy layer

Ref	Tensión/Voltage	Potencia/Power	Dimensiones/Sizes	Peso/Weight
68651	220-230 V; 50/60 Hz	650 W	Ø10 cm	1,132 Kg
68652	220-230 V; 50/60 Hz	1000 W	Ø12 cm	1,268 Kg

# Baños maría CHOCOLATE

Inox  
18/10



· Semiprofessional use ·

**Permite fundir chocolate y mantenerlo caliente**  
It allows you to melt chocolate and keep it hot



**Cazo desmontable de acero inoxidable 18/10 de gran calidad**  
High quality 18/10 st. steel collapsible pan



- **Funcionamiento sencillo gracias a sus dos posiciones; una para fundir y otra para mantener el calor.**
- **Prepara fácilmente coberturas para tus postres.**
- **Añade especias (canela, jengibre en polvo, pimentas, vainilla) para obtener un chocolate más intenso.**
- **Puedes utilizarlo como una fondue; degustar brochetas de frutas, hojaldres, etc.**

- Fonctionnement simple grâce à ses deux positions : l'une pour fondre et l'autre pour maintenir la chaleur.
- Préparez facilement des nappages pour vos desserts.
- Ajoutez des épices (cannelle, gingembre en poudre, poivre, vanille,...) pour obtenir un chocolat plus intense.
- Peut être utilisée comme pour une fondue : déguster des brochettes de fruits, des biscuits feuilletés, etc.

- Benutzerfreundlich dank doppelter Auslegung: einmal zum Schmelzen und einmal zum Warmhalten.
- Für die einfache Zubereitung von Dessert-Glasuren.
- Mit Zimt, Ingwerpulver, Pfeffer oder Vanille verfeinern um eine aromatischere Schokolade zu erhalten.
- Auch für Fondue und zum Verkosten von Obst am Spieß, Blätterteiggebäck usw.

- Easy to use because it has two positions: one for melting and the other for containing heat.
- Make toppings for your desserts easily.
- Add spices (cinnamon, powdered ginger, pepper or vanilla) to get more intense chocolate.
- You can use it for fondue or with fruit skewers, puff pastries, etc.

- Funcionamento simples, com apenas duas posições; uma para fundir e outra para manter o calor.
- Prepare facilmente coberturas para os seus doces.
- Acrescente especiarias (canela, gengibre em pó, pimentas, baunilha) para obter um chocolate com um sabor mais intenso.
- Pode utilizá-lo como fondue, para saborear espetadas de frutas, folhados, etc.

## Baño maría chocolate

Bain marie de chocolat  
Bain Marie topf für Schokolade  
Chocolate bain marie  
Banho-maria chocolate

Ref	€	W	U.Venta
69317	41,70	50	1

new



**Compatible con cubetas GN1/6 de Lacor**  
It's compatible with GN1/6 pans from Lacor



**Calentamiento 3D**  
3D Heating

- **Perfecta para elaborar coberturas de alta calidad y mantenerlas a la temperatura deseada durante horas.**
- **Ideal para la obtención de un glaseado brillante para pasteles, tartas, cake pops, muffins, etc.**
- **Contenedor GN1/6 (1,50L) y tapa extraíble de acero inoxidable 18/10 para garantizar una rápida y efectiva limpieza (aptos para el lavavajillas).**
- **Regulación de temperatura por termostato de 0°C a 60°C**
- **Calentamiento 3D; el calor se distribuye de manera uniforme por toda la superficie del recipiente.**
- **Luz indicadora, se enciende tan pronto como se alcanza la temperatura deseada.**
- **Compatible con cubetas GN1/6 de Lacor.**

- Parfait pour élaborer des nappages de grande qualité et les garder à la température souhaitée pendant des heures.
- Idéal pour obtenir un glaçage brillant pour les gâteaux, tartes, cakes pop, muffins, etc.
- Conteneur GN1/6 (1,50L) et couvercle extractible en acier inoxydable 18/10 pour garantir un nettoyage rapide et efficace (compatibles avec le lave-vaisselle).
- Réglage de la température par thermostat de 0°C à 60°C
- Chauffe 3D ; la chaleur est répartie uniformément sur toute la surface du récipient.
- Indicateur lumineux, qui s'allume dès que la température souhaitée est atteinte.
- Compatible avec les cuves GN1/6 de Lacor.

- Perfect for making high quality toppings and keeping them at the desired temperature for hours
- Ideal for getting shiny glazing on pies, cakes, cake pops, muffins, and more
- It has a GN1/6 (1.5 L) container and removable 18/10 stainless steel lid to make cleaning fast and effective. Dishwasher safe.
- The temperature can be regulated with a thermostat from 0°C to 60°C.
- 3D Heating: Heat is distributed evenly over the entire surface of the container.
- The indicator lights up as soon as the desired temperature is reached.
- It's compatible with GN1/6 pans from Lacor.

## Baño maría chocolate

Bain marie de chocolat  
Bain Marie topf für Schokolade  
Chocolate bain marie  
Banho-maria chocolate

Ref	€	W	U.Venta
69617	75,50	80	1

Ref	Tensión/Voltage	Potencia/Power	Temperatura/Temp.	Capacidad/Capacity	Dimensiones/Sizes	Peso/Weight
69317	230-240 V / 50-60 Hz	50 W	40-50°C	1,0 L (máx)	29x22x12 cm	0,875 Kg
69617	230-240 V / 50-60 Hz	80 W	0-60°C	1,5 L (máx)	22,5x26x14,5 cm	1,250Kg

# Chocolatera CHOCOSWEET

new

Inox



· Professional use ·



- Chocolatera profesional diseñada para mezclar y calentar chocolate al baño maría.
- Cubeta de policarbonato de 5 litros de capacidad.
- Termostato regulable de 0°C a 90°C.
- Sensor para prevenir posibles sobrecalentamientos.
- Sistema **NonStop**: movimiento continuo para conseguir resultados sin grumos y de consistencia perfecta.
- Grifo con sistema antigoteo y antiobstrucción, totalmente desmontable.
- Ideal para bares, restaurantes, cafeterías, hoteles, catering, foodtrucks, etc.
- Bandeja antigoteo con sistema de aviso.
- Base antideslizante. Fácil limpieza.

- Chocolatière professionnelle conçue pour mélanger et chauffer du chocolat au bain marie.
- Cuve en polycarbonate d'une capacité de 5 litres.
- Thermostat réglable de 0°C à 90°C.
- Détecteur pour prévenir d'éventuelles surchauffes.
- Système **NonStop** : mouvement continu pour obtenir des résultats sans grumeaux et d'une consistance parfaite.
- Robinet avec système anti-gouttes et anti-obstruction, entièrement démontable.
- Idéale pour les bars, restaurants, cafétérias, hôtels, traiteurs, foodtrucks, etc.
- Plateau anti-gouttes avec système d'avertissement.
- Base antidérapante. Nettoyage facile.

- Profi-Gerät zum Mischen und Erwärmen von Schokolade im Wasserbad.
- 5 l Behälter aus Polycarbonat.
- Einstellbares Thermostat von 0° C bis 90° C.
- Sensor-gesteuerter Überhitzungsschutz.
- **NonStop**-System: Dauer-Rührwerk sorgt für perfekte Konsistenz ohne Klümpchen.
- Hahn tropft und verstopft nicht und ist komplett herausnehmbar.
- Ideal für Bars, Restaurants, Cafeterias, Hotels, Catering usw.
- Auffangschale mit Überlaufwarnung.
- Rutschfester Sockel. Einfache Reinigung.

- Professional chocolate maker designed to mix and heat chocolate in a bain-marie.
- 5 litre capacity polycarbonate container.
- Adjustable 0°C to 90°C thermostat.
- Sensor to prevent possible overheating.
- **NonStop** System: Continuous motion for lump-free results and perfect consistency.
- Fully detachable tap with anti-drip and anti-clogging system.
- Ideal for bars, restaurants, cafés, hotels, catering, foodtrucks, etc.
- Non-drip tray with warning system.
- Non-slip base. Easy to clean.

- Chocolateira profissional concebida para misturar e aquecer chocolate em banho-maria.
- Cuvete de policarbonato de 5 litros de capacidade.
- Termóstato regulável de 0 a 90 °C.
- Sensor para prevenir o aquecimento excessivo.
- Sistema **NonStop**: movimento contínuo para conseguir resultados sem grumos e com uma consistência perfeita.
- Torneira com sistema antigotejamento e antiobstrução, totalmente desmontável.
- Ideal para bares, restaurantes, cafeterias, hotéis, catering, foodtrucks, etc.
- Bandeja antigotejamento com sistema de aviso.
- Base antideslizante. Fácil de limpar.

5,0 l



## Chocolatera CHOCOSWEET

Chocolatière  
Schokoladenkocher  
Chocolate machine  
Chocolateira

Ref	€	W	L	U.Venta
69615	840,00	1000	5,0	1



**Sistema NonStop**  
Movimiento continuo  
NonStop system  
Continuous movement



**Termostato regulable**  
Adjustable thermostat  
(0°C a 90°C)



**Grifo antiobstrucción**  
Barra frontal: permite  
eliminar cualquier resto  
Anti-clogging faucet  
Front bar: allows  
remove any rest

Ref	Tensión/Voltage	Potencia/Power	Temperatura/Temp.	Capacidad/Capacity	Dimensiones/Sizes	Peso/Weight
69615	220-240 V; 50 Hz	1000 W	0°C - 90°C	5 L	28x41x46,5 cm	6,80 Kg

# Fuentes de CHOCOLATE



· Semiprofessional use ·



## Fuente de chocolate

Fontaine chocolat  
Schokoladen Fontäne  
Chocolate fountain  
Fonte chocolate

	Ref	€	W	Tower	U.Venta
<b>A</b>	69318	60,10	35	18 cm	1
<b>B</b>	69319	102,20	80	38 cm	1

Ref	Tensión/Voltage	Potencia/Power	Temperatura/Temp.	Capacidad/Capacity	Torre/Tower	Dimensiones/Sizes	Peso/Weight
69318	220-240 V; 50/60 Hz	35 W	40°C - 50°C	0,50 L (máx)	18 cm (height)	Ø16x30 cm	1,15 Kg
69319	220-240 V; 50/60 Hz	80 W	40°C - 50°C	1,80 L (máx)	38 cm (height)	Ø23x54,5 cm	2,05 Kg

# Aerógrafo con compresor DECORACIÓN



· Professional use ·

Incluye una caja acolchada para almacenar el aerógrafo  
Includes a padded box for storing the airbrush



**Soporte**  
Soporte para aerógrafo de 360° para un uso práctico  
360° airbrush stand for practical use

**Compresor**  
Provee o inyecta el aire en el aerógrafo  
Provides and feeds air into the airbrush

**Tubo conector (1,8 m)**  
Manguera textil flexible con dos conexiones que traslada el aire del compresor al aerógrafo  
Flexible cloth hose with two connections that carries air from the compressor to the airbrush

**Regulador de aire**  
Aumenta y disminuye el caudal de salida  
Increase and decrease the output flow

**Ampolla de recarga**  
Llave  
Ampolla; recarga de pintura  
Llave; monta/desmonta la boquilla  
Flask, paint refill  
Spanner, assemble/disassemble the nozzle

**Aerógrafo**  
Genera un fino chorro de pintura para recubrir superficies o realizar dibujos mediante la palanca  
Deposito de 7 ml  
Creates a fine spray of paint for covering surfaces or making drawings by lever  
7 ml tank

## Aerógrafo con compresor

Aérographe avec compresseur  
Airbrush Spritzpistole mit Kompressor  
Airbrush with compressor  
Aerógrafo com compressor

Ref	€	W	Presión	Caudal	U.Venta
69450	103,20	20	0 - 2 bar	0 - 10 L/min	1

Ref	Tensión Voltage	Potencia Power	Presión Pressure	Caudal aire Air flow	Capacidad Capacity	Long. tubo aire Air tube length	Aerógrafo Airbrush	Med. compresor Compressor size	Peso Weight
69450	220-240 V ; 50/60 Hz	20 W	0 - 2 bar	0 - 10 L/min	7 ml	1,80 m	14,2x2,5x9	11,5x13,5x6 cm	800 g

# CHAFING DISH · CALENTADORES eléctricos



· Professional use ·



**Cubeta GN 1/1 en Inox (h=65 mm / 8,50 L)**  
GN 1/1 st steel container (h=65 mm / 8,5 L)

**Tapa y cubeta en inox incluidas**  
Stainless steel lid and bucket included



- Ideal para el sector de la hostelería, restauración y catering.
- Mantiene la temperatura de los alimentos.
- Más seguro al carecer de llama de los geles.
- Tapa y cubeta extraíble GN 1/1 h=65 mm (8,50 L) fabricados en acero inoxidable de alta calidad. Cuerpo fabricado en polipropileno.
- Termostato regulable (85°C +/-10°C).
- Interruptor de encendido y apagado. Indicador luminoso.
- Protección contra sobrecalentamiento.
- Fácil de transportar gracias a sus asas laterales.
- 6 pies antideslizantes y resistentes para mantener la estabilidad.

- Parfait pour le secteur hôtelier, la restauration et le traiteur.
- Conserve la température des aliments.
- Plus sûr parce qu'il n'y a pas de flamme des gels.
- Couvercle et bac amovible GN 1/1 h=65 mm (8,50 L) en acier inoxydable de haute qualité. Corps fabriqué en polypropylène.
- Thermostat réglable (85 °C +/- 10 °C).
- Interrupteur marche/arrêt. Indicateur lumineux.
- Protection contre les surchauffes.
- Facile à transporter grâce à ses poignées latérales.
- 6 pieds antidérapants et résistants pour maintenir la stabilité.

- Ideal for the hospitality, restaurant and catering sectors.
- Maintains temperature of food.
- Safer than chafing dishes that use gel fuels.
- Removable lid and tray GN 1/1 h=65 mm (8.5 L) manufactured in high-quality stainless steel. Body manufactured in polypropylene.
- Adjustable thermostat (85°C +/-10°C).
- On / Off switch. Light indicator.
- Overheating protection.
- Easily portable using the side handles.
- 6 non-slip resistant bases to ensure stability.

## Combinaciones posibles de cubetas · Possible tray options

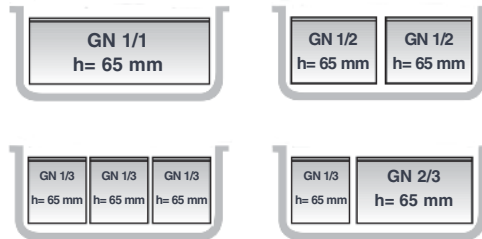

## Chafing dish eléctrico

Chafing dish électrique  
Elektrische Chafing Dish  
Electric chafing dish  
Chafing dish eléctrico

Ref	€	W	U.Venta
69336	178,10	900	1

Ref	Tensión/Voltage	Potencia/Power	Capacidad/Capacity	Temperatura/Temp.	Cubeta/Container	Dimensiones/Sizes	Peso/Weight
69336	220-240 V / 50-60 Hz	900 W	8,50 L	85°C (+/-10°C)	1GN 1/1 h=65 mm	55x34,5x25 cm	3,90 Kg

**A** 96°C  
max



## Calentador para chafing

Corp de chauffe pour bain marie  
Heizung für chafing dish  
Heating unit for chafing dish  
Aquecedor para chafing dish

Ref	€	W	U.Venta
<b>A</b> 69002	185,60	700	1
<b>B</b> 69012	214,70	700	1

Con regulador · With regulator

**B** 92°C  
max



Ref	Tensión/Voltage	Potencia/Power	Temp./Temp.	Dimensiones/Sizes	Adapt.
69002	220-240 V; 50/60 Hz	700 W	96°C (máx)	25x20 cm	69015-69000 69001-69004 69110
69012	220-240 V; 50/60 Hz	700 W	92°C (máx)	25x20 cm	

# Ollas CALENTADORAS



· Professional use ·

- Mantiene caliente todo tipo de sopas, salsas, consomés y líquidos.
- Ideal para cantidades grandes.
- Control de temperatura regulable por termostato.
- Cubeta interior desmontable.
- Alta resistencia y durabilidad.

- Maintenir au chaud tout type de soupes, sauces, consommés, liquides, etc.
- Idéal pour de grandes quantités.
- Contrôle de la température réglable par thermostat.
- Seau intérieur amovible.
- Haute résistance et durabilité.

- Warmhalten aller Arten von Suppen, Saucen, Konsommees, Flüssigkeiten, usw.
- Ideal für große Mengen.
- Temperaturregelung über Thermostat einstellbar.
- Herausnehmbarer Inneneimer.
- Hohe Beständigkeit und Haltbarkeit.

- Keep all kinds of soups, sauces, consommés, liquids etc hot.
- Ideal for large amounts.
- Temperature control adjustable by thermostat.
- Removable inner bucket.
- High resistance and durability.

- Manter quente todo o tipo de sopas, molhos, consomés, líquidos, etc.
- Ideal para grandes quantidades.
- Controle de temperatura ajustável por termostato.
- Balde interno removível.
- Alta resistência e durabilidade.

**A**

**Inox 18/10**



**B**



**C**



**D**

**Repuesto para las ref.: 69037-69038**  
Replacement for ref.: 69037-69038

**Contenedor sopa Inox 18/10**  
18/10 St. Steel soup container

**Capacidad: 10 L / Medidas: Ø24x25 cm**  
Capacity: 10 l / Sizes: Ø24x25 cm



## Olla calentador sopa PROFESIONAL

Marmite Buffet chaud  
Suppen- und Speisenwärmer  
Soup kettle  
Panela aquecedora de sopa

Ref	€	U.Venta	
<b>A</b> 69267	289,90	1	<b>Inox 18/10</b> · 18/10 stainless steel
<b>B</b> 69037	173,90	1	<b>Hierro esmaltado</b> · Enameled iron
<b>C</b> 69038	245,20	1	<b>Inox</b> · St steel
<b>D</b> 69039	58,10	1	<b>Repuesto</b> · Replacement (69037-69038)

Ref	Tensión/Voltage	Potencia/Power	Temperatura/Temp.	Capacidad/Capacity	Dimensiones/Sizes	Peso/Weight
69267	220-240 V; 50/60 Hz	800 W	30°C - 90°C	11,0 L	Ø33x32 cm	4,50 Kg
69037	220-240 V; 50/60 Hz	400 - 475 W	30°C - 90°C	10,0 L	Ø34,5x36 cm	4,50 Kg
69038	220-240 V; 50/60 Hz	400 - 475 W	30°C - 90°C	10,0 L	Ø34,5x36 cm	4,50 Kg

# Calentador de BIBERONES

new



· Professional use ·

**Incluye 2 botellas de 550ml**  
Includes two 550 ml bottles



- Fabricada en acero inoxidable de alta calidad con aislamiento térmico.
- Sistema de calentamiento en seco y homogéneo.
- Permite mantener calientes preparaciones previamente elaboradas.
- Cómodo y fácil de usar.
- Termostato regulable de temperatura independiente.
- Incluye 2 botellas de 550ml de capacidad con 3 boquillas dispensadoras.
- Compatible con nuestras botellas biberón (Ref.: 61974-61977).

- Fabriqué en acier inoxydable de grande qualité avec isolation thermique.
- Système de chauffe à sec et homogène.
- Permet de garder au chaud les préparations préalablement élaborées.
- Pratique et facile à utiliser.
- Thermostat réglable indépendant.
- Inclut 2 flacons verseurs d'une capacité de 550 ml avec 3 bords verseurs.
- Compatible avec nos flacons verseurs (Réf. : 61974-61977).

- Made of high quality stainless steel with thermal insulation.
- Dry and homogeneous heating system.
- Lets you keep prepared food hot.
- Easy to use and convenient.
- Independent adjustable temperature thermostat.
- Includes two 550 ml bottles with capacity for 3 dispenser mouths.
- Compatible with our squeeze bottles (Ref.: 61974-61977).

## Calentador de botellas biberón

Chauffe-sauces  
Flaschenwärmer  
Squeeze bottle warmer  
Aquecedor de garrafas dispensadoras

Ref	€	W	U.Venta	
69242	244,90	160	1	
R69242H	9,70	-	1	Botella biberón · Squeeze bottle

Ref	Tensión/Voltage	Potencia/Power	Temperatura/Temp.	Dimensiones/Sizes	Peso/Weight
69242	220-240 V ; 50/60 Hz	160 W	30°C - 80°C	30,5x25x23 cm	11,0 Kg

# Baño maría GN 1/1



· Professional use ·

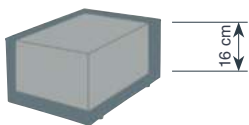

**Combinaciones de cubetas posibles**  
Possible tray options



1 x GN 1/1 - 150



2 x GN 1/2 - 150

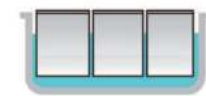

3 x GN 1/3 - 150

## Baño maría GN 1/1 150 mm

Bain-marie en inox GN 1/1 150 mm  
Bain Marie, GN 1/1 150 mm, Rostfrei  
St. steel bain-marie GN 1/1 150 mm  
Banho-maria GN 1/1 150 mm

Ref	€	W	U.Venta
69036	233,50	1300	1

Ref	Tensión/Voltage	Potencia/Power	Temperatura/Temp.	Capacidad/Capacity	Dimensiones/Sizes	Peso/Weight
69036	230 V; 50 Hz	1300 W	85°C	24 L	61,5x39x30 cm	8,50 Kg



# Placas de CALENTAMIENTO

Inox  
18/10



· Professional use ·



## Calentador BUFFET 3x GN 1/3

Chauffe  
Warmer  
Warmer  
Aquecedor

Ref	€	W	U.Venta
69445	99,70	300	1



## Placa calentamiento

Plaque pour Chauffante  
Warmhalteplatte  
Warming Plate  
Placa aquecimento

Ref	€	W	U.Venta
69045	92,50	300	1



## Placa calentamiento Vitrocerámica

Plaque vitrocéramique chaleur  
Glaskeramikkheizplatte  
Hob heating plate  
Placa aquecimento vitrocerâmica

Ref	€	W	U.Venta
69145	204,70	230	1

## Platos y bandejas siempre calientes

Ensures dishes and trays are always warm

- Una solución perfecta para profesionales de hostelería, buffet, eventos, catering, ferias...
- Ideal para mantener los alimentos calientes antes de servirlos en la mesa a una temperatura perfecta.
- Termostato regulable en temperatura.
- Tres contenedores de calentamiento GN 1/3 de 2,5 L con tapas transparentes de policarbonato, ideales para albergar una gran variedad de alimentos.
- Marco soporte de acero inoxidable (Ref.: 69445).
- Puede usarlo como placa de calentamiento para calentar platos y preparados, quitando el soporte y los contenedores (Ref.: 69445).
- Asas aislantes de calor y patas antideslizantes.
- **NO cocinar sobre la misma placa.**

- Une solution parfaite pour les professionnels de l'hôtellerie, buffets, événements, traiteurs, salons, ...
- Idéale pour garder au chaud d'aliments avant de les servir à table à une température parfaite.
- Thermostat réglable en température.
- Trois conteneurs de réchauffage GN 1/3 de 2,5 L avec couvercles transparents en polycarbonate, parfaits pour accueillir une grande variété d'aliments. Cadre support en acier inoxydable (Ref.: 69445).
- Peut être utilisé en tant que plaque pour réchauffer des plats et des préparations culinaires, en retirant le support et les conteneurs (Ref.: 69445).
- Poignées isolantes de la chaleur et pieds antidérapants.
- **NE PAS** cuisiner sur la même plaque.

- Die perfekte Lösung für Gastgewerbe, Buffets, Veranstaltungen, Catering, Messen ...
- Ideal zum Warmhalten von Speisen, bevor sie bei perfekter Temperatur am Tisch serviert werden.
- Thermostat mit Temperaturregelung.
- Drei Heizbehälter GN 1/3 mit einem Volumen von 2,5 l und durchsichtigen Polycarbonat-Decke, ideal zum Aufbewahren vielfältiger Lebensmittel
- Tragrahmen aus Edelstahl (Ref.: 69445).
- Kann bei Entfernen des Halters und der Behälter als Heizplatte zum Erwärmen von Speisen und Fertiggerichten verwendet werden (Ref.: 69445).
- Isolierte Griffe und rutschfeste Füße.
- **NICHT** direkt auf der Platte kochen.

- A perfect solution for hospitality, buffet, events, catering and trade show professionals...
- Ideal for keeping the food warm before serving them at a perfect temperature.
- Temperature-adjustable thermostat.
- Three GN 1/3 2.5 L heating containers with transparent polycarbonate lids, perfect for storing a wide variety of food. Stainless steel support frame (Ref.: 69445).
- It can be used as a heating plate to warm up food or prepared dishes if the support and the containers are taken off (Ref.: 69445).
- Heat-isolating handles and non-slip feet.
- **DO NOT** cook on the same tray.

- Uma solução perfeita para profissionais da hotelaria, buffets, eventos, catering, feiras...
- Ideal para manter quentes os alimentos, para os servir à mesa a uma temperatura perfeita.
- Termostato de temperatura regulável.
- Três recipientes de aquecimento GN 1/3 de 2,5 litros, com tampas transparentes de policarbonato, ideais para armazenar uma grande variedade de alimentos.
- Marco de suporte em aço inoxidável (Ref.: 69445).
- Pode utilizar-se como placa de aquecimento para aquecer pratos e preparados, retirando o suporte e os recipientes (Ref.: 69445).
- Asas isoladoras do calor e patas antideslizantes.
- **NÃO** cozinhar na própria placa

Ref	Tensión/Voltage	Potencia/Power	Contenedor/Container	Temp. máx./ Max. temp.	Placa/Plate	Dimensiones/Sizes	Peso/Weight
69445	220-240 V; 50/60 Hz	300 W	GN 1/3 - 2,5 L (3)	80°C (max)	53x35,8 cm	65x38x15,4 cm	4,20 Kg
69045	220-240 V; 50/60 Hz	300 W	-	80°C (max)	53x35,5 cm	65x38x6,2 cm	2,60 Kg
69145	220-240 V; 50/60 Hz	230 W	-	60°C - 105°C (max)	55x36,5 cm	62x36,5x4,5 cm	4,10 Kg

# Calentador **BUFFET**

Inox



· Professional use ·



- Ideal para grandes cocinas, buffet, catering o comedores.
- Mantiene los platos a temperatura perfecta durante un tiempo prolongado.
- Estructura de acero inoxidable de alta calidad y resistente.
- Placa calentadora de acero inoxidable con regulación de temperatura entre 40°C - 90°C.
- Lámparas halógenas para garantizar una temperatura homogénea con regulación independiente para cada una de ellas.
- Pantalla protectora de plexiglás altamente resistente.

- Idéal pour grandes cuisines, buffets, traiteurs ou cantines.
- Maintient les plats à la température parfaite pendant un laps de temps prolongé.
- Structure en acier inoxydable de grande qualité et résistant.
- Plaque chauffante en acier inoxydable avec réglage de température de 40°C à 90°C.
- Ampoules halogènes pour garantir une température homogène avec réglage indépendant pour chacune d'entre elles.
- Écran de protection en plexiglas hautement résistant.

- Ideal für Großküchen, Buffets, Catering oder Restaurants.
- Hält Speisen über längere Zeit auf perfekter Temperatur.
- Aus hochwertigem und widerstandsfähigem Edelstahl hergestellter Aufbau.
- Heizplatte aus Edelstahl mit Temperaturreglung zwischen 40°C bis 90°C.
- Individuell einstellbare Halogenlampen sorgen für gleich bleibende Temperatur.
- Schutzschirm aus hoch widerstandsfähigem Plexiglas.

- Perfect for large kitchens, buffets, catering or dining rooms.
- It keeps food at the perfect temperature for an extended period.
- Durable high quality stainless steel structure.
- Stainless steel heating plate with adjustable temperature from 40° C to 90° C.
- The halogen lamps guarantee even temperature and each one can be adjusted independently.
- High impact perspex safety screen.

- Ideal para cozinhas grandes, buffets, catering e refeitórios.
- Mantém os pratos à temperatura perfeita durante um tempo prolongado.
- Estrutura de aço inoxidável de alta qualidade e resistência.
- Placa aquecedora em aço inoxidável com regulação de temperatura entre 40 - 90 °C.
- Lâmpadas de halogéneo para garantir uma temperatura homogénea, com regulação individual e independente.
- Placa protetora de metacrilato, altamente resistente.



**Incluye bombillas infrarrojos (Ref.: R69061A)**  
Includes infrared heating bulbs



## Calentador **BUFFET DUAL**

Plaque électrique  
Warmhalteplatte  
Electric warming plate  
Placa aquecimento elétrico

Ref	€	W (Placa)	W (Lámp.)	U.Venta
69562	519,20	500	2x250	1



## Calentador **BUFFET TRIPLE**

Plaque électrique  
Warmhalteplatte  
Electric warming plate  
Placa aquecimento elétrico

Ref	€	W (Placa)	W (Lámp.)	U.Venta
69563	684,10	650	3x250	1

Ref	Tensión/Voltage	Pot. Placa/Plate P.	N° Lámp./Lamps	Pot. Lámp./Lamp P.	Temperatura/Temp.	Dimensiones/Sizes	Peso/Weight
69562	220-240 V; 50/60 Hz	500 W	2	250 W	40°C - 90°C	78x53x70 cm	12,5 Kg
69563	220-240 V; 50/60 Hz	650 W	3	250 W	40°C - 90°C	107x53x70 cm	16,5 Kg

# LÁMPARAS de calentamiento



· Professional use ·

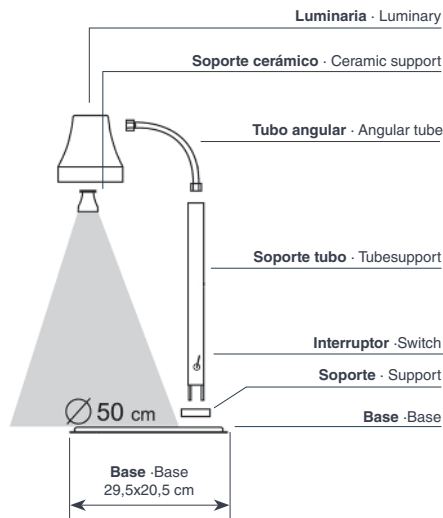

- Para uso profesional en hostelería.
- Mantiene calientes los platos. Calentamiento por infrarrojos.
- Se aconseja mantener la lámpara a 50 - 60 cm de distancia de los platos.
- Bombilla para todas nuestras lámparas de calentamiento.

- Pour un usage professionnel en hôtellerie.
- Maintient les plats au chaud. Chauffe par infrarouges.
- Il est conseillé de maintenir la lampe à une distance de 50 - 60 cm des plats.
- Ampoule pour toutes nos lampes chauffantes.

- Für den Einsatz im Gastronomiebereich.
- Hält die Speisen warm. Erwärmung durch Infrarotstrahlen.
- Es wird empfohlen, einen Abstand von 50 bis 60 cm zwischen der Lampe und den Speisen einzuhalten.
- Glühbirne für alle unsere Heizlampen.

- For professional catering use.
- Hält die Speisen warm. Infrared heating.
- It is recommended that the lamp is kept at a distance of 50-60cm from the plates.
- Bulb for all our heating lamps.

- Para uso profissional em hotelaria.
- Mantém os pratos quentes. Aquecimento por infravermelhos.
- É recomendável manter as lâmpadas a uma distância de 50 a 60 cm dos pratos.
- Bulbo para todas as nossas lâmpadas de aquecimento.

**Apta para todas nuestras lámparas de calentamiento**  
Suitable for all our heating lamps

## Bombilla infrarrojos

Ampoule infrarouge  
Infrarot Glühbirne  
Infrared heating bulb  
Lampada infravermelho



**Incluye bombillas infrarrojos (Ref.: R69061A)**  
Includes infrared heating bulbs

Ref	€	W	U.Venta
R69061A	9,80	275	1



**AL**

Aluminium

## Lámpara calentamiento infrarrojos

Lampe de chauffage infrarouge  
Infrarot Wärmelampe  
Infrared heating lamp  
Lampara calor infravermelho



**Regulable en altura**  
Height adjustable

	Ref	€	W	U.Venta
<b>A</b>	69361	105,10	275	1
<b>B</b>	69061	145,40	550	1



**Inox**  
18/10

## Lámpara de calentamiento infrarrojos

Lampe de chauffage infrarouge  
Infrarot Wärmelampe  
Infrared heating lamp  
Lampara calor infravermelho

	Ref	€	W	U.Venta
<b>A</b>	69263	473,50	275	1
<b>B</b>	69264	615,50	550	1

Ref	Tensión/Voltage	Potencia/Power	Dimensiones/Sizes	Peso/Weight
69361	220-240 V; 50/60 Hz	275 W	34x33x56 -71 cm	1,15 Kg
69061	220-240 V; 50/60 Hz	550 W	36x45x61 - 75 cm	1,58 Kg
69263	220-240 V; 50/60 Hz	275 W	31x23x79 cm	6,0 Kg
69264	220-240 V; 50/60 Hz	550 W	36x36x76 cm	7,0 Kg

# LÁMPARAS de calentamiento extensibles



· Professional use ·



- Para uso profesional en hostelería.
- Mantiene calientes los platos. Calentamiento por infrarrojos.
- Se aconseja mantener la lámpara a 50 - 60 cm de distancia de los platos.
- Bombilla para todas nuestras lámparas de calentamiento.

- Pour un usage professionnel en hôtellerie.
- Maintient les plats au chaud. Chauffe par infrarouges.
- Il est conseillé de maintenir la lampe à une distance de 50 - 60 cm des plats.
- Ampoule pour toutes nos lampes chauffantes.

- Für den Einsatz im Gastronomiebereich.
- Hält die Speisen warm. Erwärmung durch Infrarotstrahlen.
- Es wird empfohlen, einen Abstand von 50 bis 60 cm zwischen der Lampe und den Speisen einzuhalten.
- Glühbirne für alle unsere Heizlampen.

- For professional catering use.
- Keeps the dishes warm. Infrared heating.
- It is recommended that the lamp is kept at a distance of 50-60cm from the plates.
- Bulb for all our heating lamps.

- Para uso profissional em hotelaria.
- Mantém os pratos quentes. Aquecimento por infravermelhos.
- É recomendável manter as lâmpadas a uma distância de 50 a 60 cm dos pratos.
- Bulbo para todas as nossas lâmpadas de aquecimento.



**Incluye bombillas infrarrojos (Ref.: R69061A)**  
Includes infrared heating bulbs



## Lámpara calentamiento infrarrojos cable extensible

Lampe de chauffage infrarouge câble extensible  
Infrarot Wärmelampe Kabel ausziehbar  
Infrared heating lamp extensible  
Lâmpara calor infravermelho cabo extensível

	Ref	€	W	U.Venta	
<b>A</b>	69266	126,70	275	1	Lijado · Sanding
<b>B</b>	69365	145,60	275	1	Cromado · Chrome
<b>C</b>	69367	145,60	275	1	Cobre · Copper

## Lámpara de calentamiento extensible cónica

Lampe chauffante extensible conique  
Wärmelampe Kabel ausziehbar, konisch  
Conical heating lamp extensible  
Lâmpada de aquecimento ext. cônica

	Ref	€	W	U.Venta	
<b>A</b>	69564	131,20	275	1	Lijado · Sanding
<b>B</b>	69566	157,50	275	1	Cromado · Chrome
<b>C</b>	69565	160,20	275	1	Cobre · Copper

Ref	Tensión/Voltage	Potencia/Power	Dist. lámp. alimentos Lamp-food distance	Peso/Weight
69266	220-240 V; 50/60 Hz	275 W	50 - 60 cm	2,00 Kg
69365	220-240 V; 50/60 Hz	275 W	50 - 60 cm	2,00 Kg
69367	220-240 V; 50/60 Hz	275 W	50 - 60 cm	2,00 Kg
69564	220-240 V; 50/60 Hz	275 W	50 - 60 cm	1,60 Kg
69566	220-240 V; 50/60 Hz	275 W	50 - 60 cm	1,60 Kg
69565	220-240 V; 50/60 Hz	275 W	50 - 60 cm	1,60 Kg

# Colección **VITRINAS** expositoras



· Professional use ·

Desde Lacor lanzamos una nueva línea de vitrinas expositoras. Un total de 5 nuevos modelos de vitrinas neutras, calientes y refrigeradas, diseñadas especialmente para presentar y exponer todo tipo de alimentos, y garantizando siempre la calidad y conservación de estos.

Lacor lance une nouvelle ligne de vitrines d'exposition. Au total, ce sont 5 nouveaux modèles de vitrines neutres, chauffantes et réfrigérées, spécialement conçues pour présenter et exposer tout type d'aliments, toujours avec la garantie de leur qualité et leur conservation.

Lacor bringt eine neue Reihe von Vitrinen heraus. Insgesamt 5 neue Modelle mit oder ohne Kühlung/Heizung, speziell zum Anrichten und Anbieten aller möglichen Speisen mit Qualitäts- und Frischegarantie.

At Lacor we're launching a new line of display cases. There are 5 new models of neutral, warm and refrigerated display cases especially designed to present and display all kinds of food and ensure its quality and conservation at all times.

Lacor lança uma nova linha de vitrinas expositoras. Um de 5 novos modelos de vitrinas neutras, aquecidas e refrigeradas, especialmente concebidas para apresentar e expor todo o tipo de alimentos, garantindo sempre a sua qualidade e correta conservação.

## Vitrina NEUTRA



Parte trasera  
Back side

Puertas traseras abatibles  
Hinged rear doors

- Vitrina neutra construida íntegramente en cristal y base de acero inoxidable.
- Diseñada para presentar y exponer sobre la barra / mostrador.
- Superficie superior curvada para una visión panorámica.
- Estante intermedio de cristal templado.
- Puerta trasera abatible.
- 4 pies de goma que garantizan máxima estabilidad.

- Vitrine neutre íntegramente fabriquée en verre et base en acier inoxydable.
- Conçue pour présenter et exposer sur le plan de travail / comptoir.
- Surface supérieure courbée pour une vision panoramique.
- Étagère intermédiaire en verre trempé.
- Porte arrière rabattable.
- 4 pieds en caoutchouc qui garantissent une qualité maximale.

- Einfache Glasvitrine mit Edelstahlsockel.
- Zum Anrichten und Anbieten von Lebensmitteln an der Bar / Theke.
- Gewölbte Glasdecke für optimale Produktpräsentation.
- Mittlere Ablage aus Hartglas.
- Hinten aufklappbar.
- 4 GummifüÙe für maximale Standfestigkeit.

- Clear countertop display case made entirely of glass, including a stainless steel base.
- Designed for presenting and displaying food on the bar/countertop.
- Full view curved upper surface.
- Middle shelf made of tempered glass.
- Hinged rear door.
- 4 rubber feet for maximum stability.

- Vitrina neutra fabricada íntegramente em vidro, com base de aço inoxidável.
- Para apresentar e expor no balcão / mostrador.
- Superfície superior curva para uma visão panorâmica.
- Prateleira intermédia de vidro temperado.
- Porta traseira rebatível.
- 4 patas de goma para total estabilidade.

### Vitrina neutra

Vitrine neutre  
Einfache Vitrine  
Clear countertop display case  
Vitrina neutra

Ref	€	cm	h (cm)	L	U.Venta
69601	285,30	55,4x37,6	37	45	1

# Vitrina TÉRMICA

**69602**

**Combinaciones posibles**  
Possible combinations

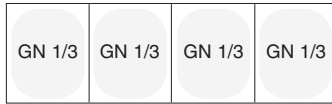
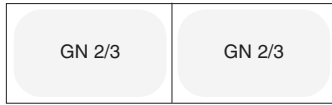

- Vitrina térmica fabricada en acero inoxidable y cristal.
- Diseñada para conservar, presentar y exponer sobre la barra / mostrador.
- Puertas correderas para una accesibilidad total.
- Superficie superior curvada para una visión panorámica.
- 4/6 cubetas gastronorm 1/3 incluidas.
- Termostato de control de temperatura regulable: 30-90°C.

- Vitrine thermique fabriquée en acier inoxydable et verre.
- Conçue pour conserver, présenter et exposer sur le plan de travail / comptoir.
- Portes coulissantes pour une accessibilité totale.
- Surface supérieure courbée pour une vision panoramique.
- 4/6 bacs gastronome 1/3 inclus.
- Thermostat de contrôle pour régler la température : 30-90°C.

**69603**

**Combinaciones posibles**  
Possible combinations

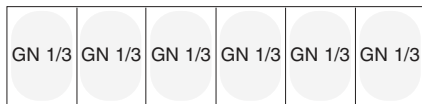
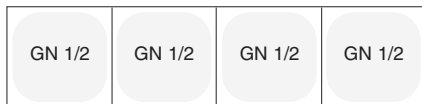

- Warmhaltevitrine aus Edelstahl und Glas.
- Zum Aufbewahren, Anrichten und Anbieten von Lebensmitteln an der Bar / Theke.
- Schiebetüren für vollständigen Zugriff.
- Gewölbte Glasdecke für optimale Produktpräsentation.
- 4/6 Gastrobehälter 1/3 inbegriffen.
- Einstellbares Thermostat: 30-90°C.

- Thermal display case made of stainless steel and glass.
- Designed for storing, presenting and displaying food on the bar/counter top.
- Sliding doors for easy access.
- Full view curved upper surface.
- 4/6 Gastronorm 1/3 trays included.
- Adjustable temperature control thermostat: 30-90°C.

- Vitrina térmica fabricada em aço inoxidável e vidro.
- Para conservar, apresentar e expor sobre o balcão / mostrador.
- Portas de correr para total acessibilidade.
- Superfície superior curva para uma visão panorâmica.
- 4/6 cusetes Gastronorm 1/3 incluídas.
- Termóstato de controlo de temperatura regulável de 30 a 90° C.



## Vitrina térmica

Vitrine thermique  
Warmhaltevitrine  
Thermal display case  
Vitrina térmica

	Ref	€	W	Capacidad	U.Venta
<b>A</b>	69602	636,20	500	4xGN1/3	1
<b>B</b>	69603	731,40	800	6xGN1/3	1

**4 / 6 cubetas gastronorm 1/3 incluidas**  
4/6 Gastronorm 1/3 trays included

**Parte trasera**  
Back side



Ref	Tensión/Voltage	Potencia/Power	Capacidad/Capacity	Temperatura/Temp.	Protección/Protection	Dimensiones/Sizes	Peso/Weight
69602	220-240 V; 50Hz	500 W	4 x GN 1/3	30°C - 90°C	IPX4	77,3x42x33,6 cm	16 Kg
69603	220-240 V; 50 Hz	800 W	6 x GN 1/3	30°C - 90°C	IPX4	112,7x42x33,6 cm	22 Kg

# Vitrina REFRIGERADA



**Control de temperatura regulable**  
Temperature control thermostat



**Tubo desagüe con tapón**  
Drain tube with cap

- Vitrina refrigerada construida íntegramente en cristal y acero inoxidable.
- Diseñada para conservar, presentar y exponer sobre la barra/mostrador.
- Puertas correderas para una accesibilidad total.
- Superficie superior curvada para una visión panorámica.
- Sistema de enfriamiento por compresor.
- 4/6 cubetas gastronorm 1/3 incluidas.
- Termostato de control de temperatura regulable: 0-12°C.
- Sistema de iluminación LED en la cámara interior y display de control de mandos.

- Vitrine réfrigérée intégralement fabriquée en verre et acier inoxydable.
- Conçue pour conserver, présenter et exposer sur le plan de travail/comptoir.
- Portes coulissantes pour une accessibilité totale.
- Surface supérieure courbée pour une vision panoramique.
- Système de refroidissement par compresseur.
- 4/6 bacs gastronome 1/3 inclus.
- Thermostat de contrôle pour régler la température : 0-12°C.
- Système d'éclairage LED dans la chambre intérieure et écran de contrôle de commandes.

- Kühlvitrine aus Glas und Edelstahl.
- Zum Aufbewahren, Anrichten und Anbieten von Lebensmitteln an der Bar/Theke.
- Schiebetüren für vollständigen Zugriff.
- Gewölbte Glasdecke für optimale Produktpräsentation.
- Kompressorkühlung.
- 4/6 Gastrobehälter 1/3 inbegriffen.
- Einstellbares Thermostat: 0-12°C.
- LED-Innenbeleuchtung und LED-Bedienfeld.

- Refrigerated display case made entirely of glass, including a stainless steel base.
- Designed for storing, presenting and displaying food on the bar/countertop.
- Sliding doors for easy access.
- Full view curved upper surface.
- Compressor cooling system.
- 4/6 Gastronorm 1/3 trays included.
- Adjustable temperature control thermostat: 0-12°C.
- LED lighting for inner chamber illumination and control display unit.

- Vitrina refrigerada fabricada integralmente em vidro e aço inoxidável.
- Para conservar, apresentar e expor sobre o balcão/mostrador.
- Portas de correr para total acessibilidade.
- Superfície superior curva para uma visão panorâmica.
- Sistema de refrigeração por compressor.
- 4/6 cusetes Gastronorm 1/3 incluídas.
- Termóstato de controlo de temperatura regulável de 0 a 12° C.
- Iluminação LED interior e display de controlo.

**Puertas traseras correderas**  
Sliding rear doors



## Vitrina refrigerada

Vitrine réfrigérée  
Kühlvitrine  
Refrigerated display case  
Vitrina refrigerada

	Ref	€	W	Capacidad	U.Venta
<b>A</b>	69605	1.236,70	160	4xGN1/3	1
<b>B</b>	69606	1.371,10	160	6xGN1/3	1

Ref	Tensión/Voltage	Potencia/Power	Capacidad/Capacity	Temperatura/Temp.	Refrigerante/Refrig.	Dimensiones/Sizes	Peso/Weight
69605	220-240 V; 50Hz	160 W	4 x GN 1/3	0°C - 12°C	R600a	112,1x45x33 cm	33 Kg
69606	220-240 V; 50 Hz	160 W	6 x GN 1/3	0°C - 12°C	R600a	148,3x45x33 cm	39 Kg

# Vitrina TÉRMICA

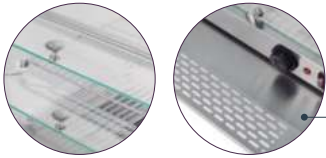

**Rejilla extraíble, facilita el flujo del calor**  
Removable racks for better heat flow



**Parte trasera**  
Back side



**Puertas traseras abatibles**  
Hinged rear doors

## Vitrina térmica

Vitrine thermique  
Warmhaltevitrine  
Thermal display case  
Vitrina tèrmica

Ref	€	W	L	U.Venta
69604	577,00	800	45	1

- Vitrina térmica fabricada en acero inoxidable y cristal.
  - Diseñada para conservar, presentar y exponer sobre la barra/mostrador.
  - Puerta trasera abatible.
  - Superficie superior inclinada para una visión panorámica.
  - Recipiente de agua extraíble que aporta humedad en la cámara.
  - Termostato de control de temperatura regulable: 30-90°C.
  - Bandeja de rejilla extraíble que facilita el flujo del calor.
- Vitrine thermique fabriquée en acier inoxydable et verre.
  - Conçue pour conserver, présenter et exposer sur le plan de travail/comptoir.
  - Porte arrière rabattable.
  - Surface supérieure inclinée pour une vision panoramique.
  - Récipient d'eau extractible qui apporte de l'humidité à la chambre.
  - Thermostat de contrôle pour régler la température : 30-90°C.
  - Plateau grillagé extractible qui facilite le flux de chaleur.
- Warmhaltevitrine aus Edelstahl und Glas.
  - Zum Aufbewahren, Anrichten und Anbieten von Lebensmitteln an der Bar/Theke.
  - Hinten aufklappbar.
  - Geneigte Glasdecke für optimale Produktpräsentation.
  - Herausnehmbarer Wasserbehälter sorgt für Luftfeuchtigkeit im Innenbereich.
  - Einstellbares Thermostat: 30-90°C.
  - Ausziehbarer Ablagerost für gute Wärmezirkulation.
- Thermal display case made of stainless steel and glass.
  - Designed for storing, presenting and displaying food on the bar/countertop.
  - Hinged rear door.
  - Full view curved upper surface.
  - Removable water tray to keep the chamber moist.
  - Adjustable temperature control thermostat: 30-90°C.
  - Removable racks for better heat flow.
- Vitrina térmica fabricada em aço inoxidável e vidro.
  - Para conservar, apresentar e expor sobre o balcão/mostrador.
  - Porta traseira rebatível.
  - Superfície superior inclinada para uma visão panorâmica.
  - Recipiente de água extraível, que preserva a humidade na câmara.
  - Termóstato de controlo de temperatura regulável de 30 a 90° C.
  - Bandeja de rede extraível, que facilita a circulação do calor.

Ref	Tensión/Voltage	Pot./Power	Capacidad/Capacity	Temp./Temp.	Protec./Protection	Parrilla/Grill	Parrilla/Grill (h)	Dimensiones/Sizes	Peso/Weight
69604	220-240 V; 50 Hz	800	45	30°C - 90°C	IPX4	52,5x28,5 cm	8,5 cm / 10 cm	55,4x37,6x37,6 cm	14,4 Kg

# Vitrina REFRIGERADA



## Vitrina refrigerada

Vitrine réfrigérée  
Kühlvitrine  
Refrigerated display case  
Vitrina refrigerada

Ref	€	W	L	U.Venta
69607	1.084,00	105	40	1



**Parte trasera**  
Back side

- Vitrina refrigerada construida íntegramente en cristal y acero inoxidable.
  - Diseñada para conservar, presentar y exponer sobre la barra/mostrador.
  - Puertas correderas para una accesibilidad total.
  - Superficie superior inclinada para una visión panorámica.
  - Sistema de enfriamiento por compresor. Función Defrost.
  - Termostato de control de temperatura regulable: 2-12°C.
  - Sist. de iluminación LED en la cámara interior y display de control de mandos.
- Vitrine réfrigérée intégralement fabriquée en verre et acier inoxydable.
  - Conçue pour conserver, présenter et exposer sur le plan de travail/comptoir.
  - Portes coulissantes pour une accessibilité totale.
  - Surface supérieure courbée pour une vision panoramique.
  - Système de refroidissement par compresseur.
  - Thermostat de contrôle pour régler la température : 0-12°C.
  - Syst. d'éclairage LED dans la chambre intérieure et écran de contrôle de commandes.
- Kühlvitrine aus Glas und Edelstahl.
  - Zum Aufbewahren, Anrichten und Anbieten von Lebensmitteln an der Ba/Theke.
  - Schiebetüren für vollständigen Zugriff.
  - Geneigte Glasdecke für optimale Produktpräsentation.
  - Kompressorkühlung. Abtaufunktion (Defrost).
  - Einstellbares Thermostat: 2-12°C.
  - LED-Innenbeleuchtung und LED-Bedienfeld.
- Refrigerated display case made entirely of glass, including a st. steel base.
  - Designed for storing, presenting and displaying food on the bar/countertop.
  - Sliding doors for easy access.
  - Full view curved upper surface.
  - Compressor cooling system. Defrost function.
  - Adjustable temperature control thermostat: 2-12°C.
  - LED lighting for inner chamber illumination and control display unit.
- Vitrina refrigerada fabricada integralmente em vidro e aço inoxidável.
  - Para conservar, apresentar e expor sobre o balcão/mostrador.
  - Portas de correr para total acessibilidade.
  - Superfície superior inclinada para uma visão panorâmica.
  - Sistema de refrigeração por compressor. Função Defrost.
  - Termóstato de controlo de temperatura regulável de 2 a 12° C.
  - Iluminação LED interior e display de controlo.

Ref	Tensión/Voltage	Potencia/Power	Capacidad/Capacity	Temperatura/Temp.	Refrigerante/Refr.	Dimensiones/Sizes	Peso/Weight
69607	220-240 V; 50Hz	105 W	40	2°C - 12°C	R600a	68x57,5x33,5 cm	25 Kg



# Colección HERVIDORES DE AGUA

Inox  
18/10



· Household use ·



- Hervidor de agua retro fabricado en acero inoxidable 18/10, acabado en gris mate.
- Permite calentar el agua de manera rápida y eficiente.
- Botón luminoso de encendido/apagado.
- Base independiente rotativa de 360°.
- Control STRIX, vida útil superior al controlador estándar. Protección contra el calentamiento en vacío muy preciso. Apagado automático.
- Visor de nivel de agua. Boquilla con filtro. Mango termorresistente.

- Bouilloire rétro fabriquée en acier inoxydable 18/10, finition gris mat.
- Permet de chauffer l'eau de façon rapide et efficace.
- Bouton lumineux de marche/arrêt.
- Base indépendante rotative à 360°.
- Contrôle STRIX, durée de vie utile supérieure au contrôleur standard. Protection contre la chauffe à vide très précis. Arrêt automatique.
- Visualisation du niveau d'eau. Buse avec filtre. Poignée thermo-résistant.

- Retro Wasserkocher. Material: Edelstahl 18/10. Farbe: Mattgrau.
- Erhitzt Wasser schnell und sparsam.
- Leuchtender Ein-/Ausschalter.
- Sockel als Einzelteil um 360° drehbar.
- STRIX-Steuerung mit überdurchschnittlicher Lebensdauer. Äußerst zuverlässiger Leerlaufschutz. Abschaltautomatik.
- Wasserstandsanzeige. Düse mit Filter. Griff hitzebeständig.

- Retro kettle made of 18/10 stainless steel with a matte grey finish.
- It can be used to heat water quickly and efficiently.
- Illuminated on/off button.
- Independent base rotates 360°.
- STRIX controller: useful life longer than a standard controller. Very precise protection against heating while empty. Automatic Shut-off.
- Water level viewer. Nozzle with filter. Heat-resistant handle.

- Fervedor de água retro, fabricado em aço inoxidável 18/10, com acabamento cinzento mate.
- Permite aquecer a água de maneira rápida e eficiente.
- Botão luminoso de ligar/desligar.
- Base independente e rotativa de 360°.
- Controlo STRIX, que proporciona uma vida útil superior à de um controlador standard. Proteção de grande precisão contra o aquecimento em vazio. Desconexão automática.
- Indicador de nível de água. Bocal com filtro. Asa termorresistente.

## Permite calentar el agua de manera rápida y eficiente

It can be used to heat water quickly and efficiently



**Base independiente rotativa de 360°**  
Independent base rotates 360°



**Botón luminoso de encendido/apagado**  
Illuminated on/off button



**Fácil llenado**  
Easy filling



**Interior inox 18/10**  
Interior 18/10 st. steel



**Boquilla con filtro**  
Nozzle with filter



**Indicador de nivel de agua**  
Water level indicator

## Hervidor de agua RETRO

Bouilloire électrique  
Elektrische Wasserwamer  
Electric kettle  
Chaleira eléctrica

Ref	€	W	L	U.Venta
69397	58,20	2200	1,7	1

Strix  
Technology



Ref	Tensión/Voltage	Potencia/Power	Capacidad/Capacity	Dimensiones/Sizes	Peso/Weight
69397	220-240 V ; 50/60 Hz	2200 W	1,70 L	26x19,5x26,5 cm	1,20 Kg



**Filtro extraíble antical**  
Removable anti-cal filter



**Visor de nivel de agua**  
Water level



**Base rotativa de 360°**  
360° rotating base



**Calefactor oculto**  
Hidden heater

**Se desactiva cuando alcanza el nivel de temperatura deseada**

It is deactivated when it reaches the desired temperature level

**Botón apertura tapa**

Cover opening button

**Botón de encendido/apagado**

On/off button



**Apagado automático**  
Automatic shutdown

**Luz LED**  
LED light

## Hervidor de agua

Bouilloire  
Wasserwamer  
Kettle  
Chaleira

	Ref	€	Color	W	L	U.Venta
<b>A</b>	69590	22,60	GREY	2200	1,30	1
<b>B</b>	69591	22,60	WHITE	2200	1,30	1

Ref	Tensión/Voltage	Potencia/Power	Capacidad/Capacity	Dimensiones/Sizes	Peso/Weight
69590	220-240 V; 50/60 Hz	2200 W	1,30 L	20x15x21 cm	0,74 Kg
69591	220-240 V; 50/60 Hz	2200 W	1,30 L	20x15x21 cm	0,74 Kg

**Strix**  
Technology



**Botón apertura tapa**  
Cover opening button



**Botón apertura tapa**  
Cover opening button



**Visor de nivel de agua**  
Water level



## Hervidor de agua LAKE

Bouilloire  
Wasserwamer  
Kettle  
Chaleira

Ref	€	W	L	U.Venta
69277	59,70	2200	1,70	1

## Hervidor de agua RAPID

Bouilloire  
Wasserwamer  
Kettle  
Chaleira

Ref	€	W	L	U.Venta
69291	39,80	1630	1,00	1
69297	49,70	2200	1,70	1

Ref	Tensión/Voltage	Potencia/Power	Capacidad/Capacity	Dimensiones/Sizes	Peso/Weight
69277	220-240 V; 50/60 Hz	2200 W	1,70 L (5 min)	23x16x23 cm	1,00 Kg
69291	220-240 V; 50/60 Hz	1630 W	1,00 L (3 min)	22x16x21 cm	1,10 Kg
69297	220-240 V; 50/60 Hz	2200 W	1,70 L (5 min)	22x18x23 cm	1,65 Kg

**Botón apertura de tapa**

Button for opening the boiler cap



**Protección de ebullición en seco**  
Dry boil protection



- Base para conector de 360°.
- Se apagará automáticamente cuando el agua hierve.
- Elemento de calefacción oculto.
- Indicador de luz de encendido/apagado.
- La temperatura se puede ajustar de 50°C-95°C.
- Almacenamiento de cable.

- Base pour connecteur de 360°.
- S'éteint automatiquement lorsque l'eau bout.
- Élément de chauffe caché.
- Indicateur lumineux de marche / arrêt.
- La température peut être réglée entre 50°C et 95°C.
- Rangement du câble.

- Base for 360° connector.
- The wireless boiler will automatically switch off when the water boils.
- Hidden heating element.
- ON/OFF light.
- The temperature can be adjusted from 50°C - 95°C.
- Cable storage.



**Cristal**

Glass

**Hervidor de agua**

Bouilloire  
Wasserwamer  
Kettle  
Chaleira

Ref	€	W	L	U.Venta
69292	80,70	2200	1,70	1

Ref	Tensión/Voltage	Potencia/Power	Temperatura/Temp.	Capacidad/Capacity	Dimensiones/Sizes	Peso/Weight
69292	220-240 V; 50 Hz	2200 W	50 - 95°C	1,70 L	23x23x32 cm	1,90 Kg



**Interior inox 18/10. Calentamiento rápido**  
Interior 18/10 st. steel. Fast heating

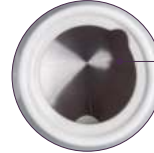

- Cuerpo cerámico, ecológico y resistente a altas temperaturas.
- Base independiente rotativa de 360°.
- Tapa extraíble con cierre.
- Indicador de capacidad máxima.
- Interruptor de encendido/apagado luminoso.
- Protección de sobrecalentamiento y funcionamiento en seco.
- Función de apagado automático.

- Corps céramique, écologique et résistant aux températures élevées.
- Base indépendante rotative à 360°.
- Couvercle extractible avec fermeture.
- Indicateur de capacité maximale.
- Interrupteur de marche/arrêt lumineux.
- Protection contre la surchauffe et fonctionnement à sec.
- Fonction d'arrêt automatique.

- Ceramic body, ecological and resistant to high temperatures.
- 360° rotating independent base.
- Removable lid with closure.
- Maximum capacity indicator.
- Light up on/off switch.
- Protection from overheating and dry running.
- Auto-off function.

**CE**

Ceramic

**Hervidor de agua cerámico**

Bouilloire en céramique  
Keramik Wasserwarmer  
Ceramic kettle  
Chaleira cerâmica

	Ref	€	Nombre	W	L	U.Venta
<b>A</b>	69276	51,70	GALA	1500	1,20	1
<b>B</b>	69289	56,50	GALA GREY	1200	1,00	1

Ref	Tensión/Voltage	Potencia/Power	Capacidad/Capacity	Dimensiones/Sizes	Peso/Weight
69276	220-240 V; 50/60 Hz	1500 W	1,2 L	24x17x25 cm	1,68 Kg
69289	220-240 V; 50/60 Hz	1200 W	1,0 L	23x16,5x23 cm	1,40 Kg

# Dispensador de agua caliente **INSTANT**

Inox



· *Semiprofessional use* ·



- Ideal para oficinas, casas rurales, reuniones, etc.
- Fácil llenado. Depósito extraíble de gran capacidad (2 L) para llenar fácilmente el contenedor.
- Display intuitivo. Elige la cantidad de agua (150 ml - 230 ml- 300 ml) y la temperatura deseada (25°C - 70°C - 85°C - 95°C).
- Cuenta con función de bloqueo de seguridad.
- Ahorra tiempo y energía. Proporciona la cantidad exacta de agua caliente deseada, el agua restante del depósito se mantendrá fría.
- Bandeja de goteo extraíble e imantada, fácil de limpiar y colocar.

- Idéal pour les bureaux, les gîtes ruraux, les réunions, etc.
- Remplissage facile. Réservoir extractible de grande capacité (2 L) pour remplir facilement le conteneur.
- Écran intuitif. Choisissez la quantité d'eau (150 ml - 230 ml- 300 ml) et la température souhaitée (25°C - 70°C - 85°C - 95°C).
- Dispose d'une fonction de blocage de sécurité.
- Gain de temps et économies d'énergie. Fournit la quantité exacte d'eau chaude souhaitée, l'eau restant dans le réservoir restera froide.
- Plateau d'écoulement extractible et aimanté, facile à nettoyer et à installer.

- Ideal für Büros, Landhäuser, Sitzungen usw.
- Einfaches Füllen. Herausnehmbarer Tank mit großem Fassungsvermögen (2 L) zum einfachen Füllen des Behälters.
- Intuitives Display. Wassermenge (150 ml - 230 ml- 300 ml) und erwünschte Temperatur (25°C - 70°C - 85°C - 95°C) wählbar.
- Mit Sicherheitssperre.
- Spart Zeit und Energie. Spendet genau die erwünschte Menge heißes Wasser, im Tank bleibendes Wasser bleibt kalt.
- Herausnehmbare und magnetische Tropfwanne, einfach zu reinigen und anzubringen.

- Perfect for offices, country homes, meetings, etc.
- Easy to fill. Large capacity (2 L) removable tank to easily fill the container.
- Intuitive display. Choose the amount of water (150 ml - 230 ml- 300 ml) and the desired temperature (25°C - 70°C - 85°C - 95°C).
- Includes safety lock feature.
- Save time and energy. Provides the exact amount of hot water desired, while the remaining water in the tank remains cold.
- Removable and magnetic drip tray, easy to clean and replace.

- Ideal para escritórios, casas de turismo rural, reuniões, etc.
- Fácil de encher. Depósito extraível de grande capacidade (2 L) para encher facilmente o recipiente.
- Ecrã intuitivo. Seleccione a quantidade de água (150/230/300 ml) e a temperatura desejada (25/70/85/95 °C).
- Função de bloqueio de segurança.
- Poupa tempo e energia. Proporciona a quantidade exata de água quente desejada; a água restante do depósito manter-se-á fria.
- Bandeja de gotejamento extraível e magnética, fácil de limpar e de colocar.

## Display intuitivo

Intuitive display



## Bandeja de goteo extraíble e imantada

Removable and magnetic drip tray

## Agua caliente en 5 segundos

Hot water in 5 seconds



## Dispensador de agua caliente

Distributeur d'eau chaude  
Heißwasserspender  
Hot water dispenser  
Dispensador de água quente

Ref	€	W	U.Venta
69298	124,50	2400	1

Ref	Tensión/Voltage	Potencia/Power	Capacidad/Cap.	Niveles Calentamiento/Heating levels	Dispensado agua/Water dispensed	Dimensiones/Sizes	Peso/Weight
69298	220-240 V / 50-60 Hz	2400 W	2,00 L	25°C - 70°C - 85°C - 95°C	150-230-300 ml	32x16,8x32,7 cm	2,50 Kg

# Colección MOLINILLOS ELÉCTRICOS

Inox  
Plastic

AS



AC



· Household use ·



69485

- Disfruta de todo el aroma y sabor de un café recién molido.
- Embudo de 200 g de capacidad con tapa.
- Fresa cónica de acero inoxidable, muele el café uniformemente.
- 19 diferentes niveles de molido. Se adapta a todo tipo de cafeteras y a la intensidad de sabor que se desee.
- Selector de tazas de 1 a 12 tazas. Mantiene los granos frescos y evita el desperdicio del café.
- Contenedor transparente extraíble de 100 g. Libre de BPA.

- Profitez de tout l'arôme et du goût du café fraîchement moulu.
- Entonnoir d'une capacité de 200 g avec couvercle.
- Une fraise conique en acier inoxydable, qui moule le café de manière régulière.
- 19 niveaux de mouture différents, elle s'adapte à tous les types de machines à café et à l'intensité de goût souhaitée.
- Sélecteur de tasses de 1 à 12 tasses, il permet de conserver la fraîcheur des grains et d'éviter le gaspillage de café.
- Récipient transparent amovible de 100 g. Sans BPA.

- Enjoy the taste and aroma of freshly ground coffee.
- Hopper with a capacity of 200 g with a lid.
- Conical stainless steel cutter to ensure the coffee is ground uniformly.
- 19 different grind sizes to choose from, suitable for all types of coffee machines and for all flavour intensities.
- Choose between 1 and 12 cups to keep the coffee grounds fresh and avoid wasting coffee.
- Removable 100 g transparent container. BPA-free.

19 diferentes niveles de molienda · 19 different grind sizes



Número de tazas Number of cups	Tiempo de molido Grinding time
2	8 seg
4	12 seg
6	20 seg
8	24 seg
10	28 seg
12	30 seg



Ideal para moler café y otros productos como semillas, hierbas, frutos secos, cereales, sal, pimienta, azúcar o especias

Perfect for grinding coffee or other products like seeds, herbs, nuts, grains, salt, pepper, sugar or spices

Depósito para 60 g de granos de café molido

Container for 60 g of ground coffee

Cuchillas de acero inoxidable de gran resistencia

High strength st. steel blades

Selector de tazas, de 1 a 12 tazas

Cup selector, 1 to 12 cups

## Molinillo de café LIMU

Moulin à café  
Kaffeemühle  
Coffe grinder  
Moedor de café



## Molinillo de café KALDI

Moulin à café  
Kaffeemühle  
Coffe grinder  
Moedor de café



Ref	€	W	g	U.Venta
69385	37,20	200	60	1

Ref	€	W	g	U.Venta
69485	117,70	200	200 / 100	1

Ref	Tensión/Voltage	Potencia/Power	Capacidad/Capacity	Niveles dispensado Levels dispensed	Niveles de molidos Grinding levels	Dimensiones/Sizes	Peso/Weight
69385	220-240 V ; 50/60 Hz	200 W	60 g (9 cups)	-	-	Ø10x18 cm	0,780 Kg
69485	220-240 V ; 50/60 Hz	200 W	200 g (granos · grains) 100 g (molido · ground)	12	19	15,2x21x26 cm	1,85 Kg

# AIRPOT



· Professional use ·

**NO UTILIZAR CON BEBIDAS GASEOSAS, CALDOS NI LÁCTEOS**  
DO NOT USE WITH FIZZY DRINKS, BROTHS OR DAIRY

**Asas laterales aislantes del calor**  
Side mounted insulated handles

**Ideal para agua, café y té**  
Perfect for water, coffee and tea

**Fabricado en acero inoxidable resistente y de alta calidad**  
Made of strong high quality stainless steel

## Airpot eléctrico

Électrique Airpot  
Elektrische Getrankenpender  
Electric Airpot  
Airpot eléctrico

Ref	€	L	U.Venta
69472	131,00	4	1
69476	141,60	6	1
69471	154,60	10	1



**Fácil sist. de apertura**  
Easy open system



**Nivel de indicador de líquido**  
Liquid level indicator



**Sist. dispensador cómodo**  
Convenient dispensing system



**Sensor de temperatura**  
Temperature sensor



**Marcas de llenado**  
Fill lines



**Posibilidad de graduar la temperatura**  
The temperature can be adjusted

Ref	Tensión/Voltage	Potencia/Power	Capacidad/Capacity	Temperatura/Temp.	Dimensiones/Sizes	Peso/Weight
69472	220-240 V / 50-60 Hz	1500 W	4 L	60°C - 100°C	28x28x35 cm	1,90 Kg
69476	220-240 V / 50-60 Hz	1500 W	6 L	60°C - 100°C	28x28x40 cm	2,00 Kg
69471	220-240 V / 50-60 Hz	1500 W	10 L	60°C - 100°C	28x28x48 cm	2,20 Kg

# Cafetera PERCOLADORA

new



· Professional use ·



**Fácil sist. de apertura**  
Easy open system

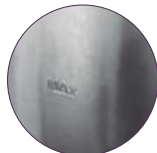

**Marcas de llenado**  
Fill lines



**Filtro microperforado**  
Micro-perforated filter



**Sist. dispensador cómodo**  
Convenient dispensing syst.

## Cafetera percolada

Percolateur à café  
Kaffee-Perkolator  
Coffee percolator  
Máquina/Percolador de café

Ref	€	W	L	U.Venta
69486	162,90	1500	6	1
69481	181,70	1500	10	1



- Fabricada en acero inoxidable de gran calidad.
- Ideal para cafeterías, restaurantes, bares, servicios de buffet y estaciones self-service.
- 2 sistemas de calentamiento independientes para la función de infusión y la función de conservación del calor.
- Distribución de calor rápida y homogénea.
- Mantiene el café a la temperatura óptima salvaguardando sus propiedades de sabor y aroma durante horas.
- Filtro de malla microperforada de acero inoxidable, especialmente diseñado para evitar la generación de posos.
- Luz indicadora de preparación. Indicador del nivel de agua. Bandeja antigoteo.
- Tapa con cierre de seguridad mediante botón de bloqueo.
- Sistema de protección contra el calentamiento en vacío.
- Opción de flujo continuo para una máxima comodidad.
- Tapa, filtro y tubo percolador aptos para el lavavajillas.

- Made of high quality stainless steel.
- Perfect for cafés, restaurants, bars, buffet services and self-serve stations.
- Two independent heating systems for the infusion function and the heat preservation system.
- Fast and even heat distribution.
- Keeps coffee at the perfect temperature so it can retain its flavour and aroma for many hours.
- Stainless steel micro-perforated filter specially designed to prevent build-up.
- In-use indicator light. Water level indicator. Anti-drip tray.
- Lid with lock button activated safety lock.
- System to protect against heating while empty.
- Continuous flow option for maximum convenience.
- The lid, filter and percolator tube are dishwasher safe.

Ref	Tensión/Voltage	Potencia/Power	Volumen/Volume	Capacidad/Capacity	Dimensiones/Sizes	Peso/Weight
69486	220-240 V; 50 Hz	1500 W	6 L	4,8 L (max)	28x28x40 cm	2,20 Kg
69481	220-240 V; 50 Hz	1500 W	10 L	8,2 L (max)	35x35x45 cm	2,80 Kg

# Colección cafeteras de GOTEO



· Professional use ·



Depósito agua  
Water deposit

Colocación filtro  
Filter placement



## Jarra café cristal

Basse en verre pichet  
Glass Kaffee Jug  
Glass coffee jug  
Caneca de café em vidro



Ref	€	L	h (cm)	U.Venta
69273	29,10	1,80	17,50	1

## Pack 200 filtros

Pack 200 filtros  
Pack200 Filter  
Pack filters U.Venta  
Pack 200 filtros



Ref	€	Ø (cm)	U.Venta
69274	16,40	25	1
69275	14,10	20	1

## Máquina de café automática

Machine à café automatique  
Automatische Kaffeemaschine  
Automatic coffee machine  
Máquina automática do café

Ref	€	Filtro / Ø	U.Venta
69272	495,70	25	1

Ref	Filtro/Filter	Tensión/Voltage	Potencia/Power	Capacidad/Cap.	Placa calent/Heating plate	Jarra/Termo Pitcher/Thermo	Dimensiones/Sizes	Peso/Weight
69272	69274	220-240 V; 50/60 Hz	2100 W	1,80 L (8 min)	2x80 W (80°C +/-4)	1,80 L Jarra (2)	20x36x41 cm	5,82 Kg

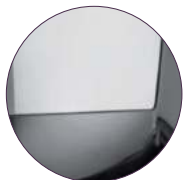

Portafiltro desmontable  
Removable folter holder

Base calentadora antiadherente  
Anti-stick heating base



## Cafetera de goteo BLACK

Cafetière filtre électrique  
Filter-Kaffeemaschine  
Filter coffe machine  
Café tipo filtro



- Puede dosificar la cantidad de café.
- Una vez encendida nos podemos desentender de ella.
- Si la jarra se completa, mantiene el café caliente y se puede consumir en cualquier momento.

- Peut doser la quantité de café.
- Une fois allumée, plus besoin de s'en occuper.
- Si la verseuse est pleine, elle maintient le café au chaud permettant ainsi de le consommer à tout moment.

- Kaffee-Dosierung möglich.
- Einmal eingeschaltet brauchen wir uns nicht um sie zu kümmern.
- Ist die Kanne voll, wird der Kaffee warmgehalten und er kann jederzeit genossen werden.

- The amount of coffee used can be controlled.
- Once switched on we can forget about it and leave it to work.
- If a full pot is prepared, it keeps the coffee hot and it can be consumed at any time.

- Pode dosear a quantidade de café.
- Uma vez ligada, não temos que nos preocupar mais.
- Uma vez cheia, a cafeteira mantém o café quente, e pode consumir-se em qualquer momento.

Ref	€	W	L	U.Venta
69278	53,70	1000	1,25	1

Ref	Tensión/Voltage	Potencia/Power	Tazas/Cups	Capacidad/Capacity	Dimensiones/Sizes	Peso/Weight
69278	220-240 V; 50/60 Hz	1000 W	10	1,25 L	31x21x22 cm	1,25 Kg



**Portafiltro desmontable**  
Removable filter holder



- Mantiene el café caliente durante 30 minutos. Se apaga automáticamente.
- Función pausa (antigoteo) para servir.
- Programable.

- Maintient le café au chaud pendant 30 minutes. S'éteint automatiquement.
- Fonction pause (anti-goutte) pour servir.
- Programmable.

- Hält den Kaffee 30 Minuten warm. Automatische Abschaltung.
- Pause-Funktion (tropffrei) zum Ausschicken.
- Programmierbar.

- Keeps the coffee hot for 30 minutes. Switches off automatically.
- Pause (anti-drip) function for serving.
- Programmierbar.

- Mantém o café quente durante 30 minutos. Apaga-se automaticamente.
- Função de pausa (anti-gotejo) para servir.
- Programável.

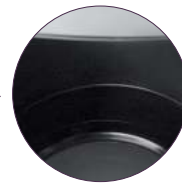

**Base calentadora antiadherente**  
Anti-stick heating base

## Cafetera de goteo programable

Cafetière filtre électrique programmable  
Filter-Kaffeemaschine, programmierbar  
Filter coffee machine  
Programavel café tipo filtro

Ref	€	W	L	U.Venta
69279	75,90	1000	1,80	1

Ref	Tensión/Voltage	Potencia/Power	Tazas/Cups	Capacidad/Capacity	Dimensiones/Sizes	Peso/Weight
69279	220-240 V; 50/60 Hz	1000 W	12	1,80 L	28x25x37 cm	3,10 Kg

**Apta para todas las jarras de cristal**  
Suitable for all glass jars

**Placa de calentamiento Ø11 cm**  
Heating plate Ø11 cm



**Placas de calentamiento independientes**  
Independent heating plates



## Placa calentamiento jarra café

Plaque chauffante pour cruche de café  
Heizplatte für Kaffeekanne  
Heating plate for coffee jug  
Placa de aquecimento caneca de café

Ref	€	Ø Placa	
69281	94,80	11	Simple
69282	118,50	11	Doble · Double

Ref	Tensión/Voltage	Potencia/Power	Temperatura/Temp.	Dimensiones/Sizes	Peso/Weight
69281	220-240 V; 50/60 Hz	90 W	80°C +/-4	19x20,5x7 cm	0,80 Kg
69282	220-240 V; 50/60 Hz	180 W	80°C + 80°C +/-4	38x20,5x7 cm	1,50 Kg



# Colección cafeteras **ESPRESSO**

Inox



· Household use ·



- Cafeteras espresso de acero inoxidable con diseño elegante y compacto.
- Ideales para preparar todo tipo de cafés, espresso, cappuccino, latte machiato, té o infusiones.
- Café perfecto y rápido gracias a su potencia y sus bares de presión.
- Sistema de calentamiento rápido Thermoblock, calienta el agua en segundos.
- Fácil de usar, muy intuitiva. Indicadores luminosos en cada función.
- Función manual y automática. Permite programar el ciclo de vertido a tu gusto.
- Incluye vaporizador con rotación para espumar leche, preparar cappuccinos y también dispensar agua caliente para las infusiones.
- Brazo portafiltros con doble salida, te permite preparar uno o dos cafés simultáneamente.
- Depósito de agua extraíble con marcas de máximo y mínimo. Libre de BPA.
- Bandeja caliente tazas de acero inoxidable, calienta la taza previamente para evitar el contraste térmico.
- Bandeja de goteo desmontable con indicador de nivel para facilitar la limpieza.
- Sistema de ahorro energético con apagado automático.
- Apta para usar con café molido y con cápsulas ESE (69256/69429).

- Stainless steel espresso maker with elegant and compact design.
- Perfect for making all kinds of coffee, espresso, cappuccino, latte macchiato, tea or infusions.
- It can make perfect coffee quickly thanks to power and bars of pressure.
- Its Thermoblock fast heating system heats water in seconds.
- It is easy to use and very intuitive and has light indicators for every function.
- Manual and automatic operation, the amount of coffee to be made can be programmed to taste.
- Swivelling steam wand included to froth milk and make cappuccino. It also dispenses hot water for infusions.
- The portafilter with two outlets lets you make one or two cups of coffee at the same time.
- It has a removable water tank with minimum and maximum marks. BPA free.
- It has a stainless steel cup heating tray to heat cups beforehand to prevent temperature contrasts.
- It has a removable drip tray with a level indicator to make cleaning easy.
- It has an energy savings system with automatic shut off.
- It can be used with ground coffee or ESE pods (69256/69429).



**Accesorios incluidos**  
Accessories included



**Apta para café molido y para usar con cápsulas ESE**  
Suitable for ground coffee and for use with ESE capsules



**Prepara 1 o 2 cafés**  
Make 1 or 2 coffees



**Calienta y espuma leche**  
Heat and froth milk



**Prensador para café molido**  
Tamper for ground coffee



**Bandeja caliente tazas**  
Cup warming tray



**Bandeja de goteo con indicador**  
Drip tray with indicator

*new*



## Cafetera espresso **COMPACT**

Cafetière espresso  
Espresso-Maschine  
Espresso coffee maker  
Cafeteira espresso

Ref	€	W	L	U.Venta
69429	228,90	1450	1,25	1

Ref	Tensión/Voltage	Potencia/Power	Presión/Pressure	Capacidad/Capacity	Dimensiones/Sizes	Peso/Weight
69429	220-240 V ; 50/60 Hz	1450 W	20 bar	1,25 L	14x31x31 cm	3,40 Kg



**Depósito de agua extraíble de 1,50 litros**  
removable 1.50 litre water tank



**Apta para café molido y para usar con cápsulas ESE**  
Suitable for ground coffee and for use with ESE capsules



**Prensador para café molido**  
Tamper for ground coffee



**Bandeja calienta tazas**  
Cup warming tray



**Bandeja de goteo con indicador**  
Drip tray with indicator

**Un café**  
A coffee



**Dos cafés**  
Two coffees



**Calentar y espumar leche**  
Heat and froth milk



## Cafetera espresso SENCE

Cafetière espresso  
Espresso-Maschine  
Espresso coffee maker  
Cafeteira espresso

Ref	€	W	L	U.Venta
69256	184,20	850	1,50	1

Ref	Tensión/Voltage	Potencia/Power	Presión/Pressure	Capacidad/Capacity	Dimensiones/Sizes	Peso/Weight
69256	220-240 V ; 50/60 Hz	850 W	15 bar	1,50 L	21x26,5x30 cm	3,60 Kg

*new*

**Molinillo con fresa cónica de acero inoxidable**  
Coffee grinder with a stainless steel cone burr



**Prepara 1 o 2 cafés**  
Make 1 or 2 coffees



**Calienta y espuma leche**  
Heat and froth milk



**Accesorios incluidos**  
Accessories included



**Prensador para café molido**  
Tamper for ground coffee



**Bandeja calienta tazas**  
Cup warming tray



**Café recién molido al instante**  
Instant fresh ground coffee



**Proporciona la cantidad necesaria**  
Provide the amount needed



**Bandeja de goteo con indicador**  
Drip tray with indicator



## Cafetera espresso PRO

Cafetière espresso  
Espresso-Maschine  
Espresso coffee maker  
Cafeteira espresso

Ref	€	W	L	U.Venta
69428	641,90	1550	2,80	1

Ref	Tensión/Voltage	Potencia/Power	Presión/Pressure	Capacidad/Capacity	Capacidad/Capacity	Dimensiones/Sizes	Peso/Weight
69428	220-240 V ; 50/60 Hz	1550 W	20 bar	2,80 L (depósito agua)	250 g (depósito café)	31x34,5x41,5 cm	8,00 Kg

# Colección ESPUMADORES DE LECHE



· Household use ·



**Calentar**  
Heat

**Calentar y espumar.**  
Espumar leche fría  
Heat and froth.  
Froth cold milk

- Disfruta de una espuma fina y cremosa en pocos segundos.
- Capacidad espuma: 115 ml / Capac. calentamiento: 240 ml (69396) - 250 ml (69398).
- Tecnología magnética; el movimiento de los accesorios se crea por atracción (69398).
- Base independiente rotativa de 360°, fácil de rellenar y verter.
- Funcionamiento silencioso. Apagado automático.
- Indicador de luz que visualiza si la leche está caliente o fría.
- Apta para leches vegetales. Fácil de limpiar.

- Obtenez une mousse fine et crémeuse en secondes seulement.
- Capacité de mousse : 115 ml / Capacité de chauffe : 240 ml (69396) - 250 ml (69398).
- Technologie magnétique, le mouvement des accessoires a lieu par attraction (69398).
- Base indépendante rotative de 360°C, sans fil, facile à remplir et à verser.
- Fonctionnement silencieux. Arrêt automatique.
- Indicateur lumineux qui indique si le lait est chaud ou froid.
- Apte pour les laits végétaux. Facile à nettoyer.

- Samtiger Schaum in nur Sekunden genussbereit.
- Milchschaum: 115 ml / warme Milch: 240 ml (69396) - 250 ml (69398).
- Magnettechnik, Zubehör bewegen sich durch Anziehungskraft (69398).
- Die Basis ist um 360° drehbar, ohne Kabel, einfaches Ein- und Ausgießen.
- Geräuscharmer Lauf. Abschaltautomatik.
- Kontrollleuchte zeigt an, ob die Milch warm oder kalt ist.
- Pflanzenmilchgeeignet. Leichte Reinigung.

- Enjoy a fine, creamy foam in as little seconds.
- Frothing capacity: 115 ml / Heating capacity: 240 ml (69396) - 250 ml (69398).
- Magnetic technology: the movement of the accessories is created with attraction (69398).
- 360° rotating independent base, easy to fill and pour.
- Silent operation. Automatic shut-off.
- The indicator light shows whether the milk is hot or cold.
- Suitable for plant milk and easy to clean.

- Desfrute de uma espuma fina e cremosa em apenas unos segundos.
- Capacid. de espuma: 115 ml / Capacid. de aquecimento: 240 ml (69396) - 250 ml (69398).
- Tecnologia magnética: o movimento dos acessórios gera-se pela atração (69398).
- Base independente rotativa de 360°, sem cabos, fácil de encher e de verter.
- Funcionamento silencioso. Desconexão automática.
- Indicador luminoso, que indica se o leite está quente ou frio.
- Apto para leites de origem vegetal. Fácil de limpar.



**Cristal**  
Glass

## Espumador de leche MAGNETIC

Mousseur à lait  
Milchaufschäumer  
Milk frother  
Espumador de leite

## Espumador de leche LATTE

Mousseur à lait  
Milchaufschäumer  
Milk frother  
Espumador de leite

Ref	€	W	ml	U.Venta
69396	61,80	500	240	1

Ref	€	W	ml	U.Venta
69398	76,80	600	250	1

Ref	Tensión/Voltage	Potencia/Power	Cap. espuma/Cap. foam	Cap. leche/Cap. milk	Base/Base	Dimensiones/Sizes	Peso/Weight
69396	220-240 V; 50/60 Hz	500 W	115 ml	240 ml	360°	Ø10x21 cm	650 g
69398	220-240 V; 50/60 Hz	600 W	115 ml	250 ml	360°	Ø11,8x19,5 cm	900 g

# Tostadoras **BUFFET**



· Professional use ·



**Tostado continuo de pan**  
Continuous bread toasting

**Doble sistema de calentamiento**  
Dual heating system

**Cinta transportadora**  
Conveyor belt

69065 - 18 cm  
69066 - 25,5 cm

## Tostadora de cinta transportadora

Toasteur professionnel  
Durchlauf toaster  
Conveyor toaster  
Torradeira de tapete rolante

Ref	€	W	U.Venta
69065	835,90	1340	1
69066	964,10	2240	1

Ref	Tensión/Voltage	Potencia/Power	Velocidad/Speed	Producción/Product.	Dimensiones/Sizes	Peso/Weight
69065	220-240 V; 50 Hz	1340 W	0,46 - 0,73 m/min.	150 h	53x37x40 cm	12,85 Kg
69066	220-240 V; 50 Hz	2240 W	0,46 - 0,73 m/min.	300 h	53x45x40 cm	15,50 Kg



**Bandeja recogemigas**  
Crumbs tray

**Hueco útil entre parrillas 5,5 cm**  
Usable gap between racks 5.5 cm

**Calentamiento infrarrojos**  
**Lámparas infrarrojas halógenas de cuarzo**  
Infrared heating Quartz halogen infrared lamps



## Tostador horizontal

Grille-pain horizontal  
Toaster horizontal  
Horizontal toaster  
Torradeira horizontal

Ref	€	W	U.Venta
<b>A</b> 69172	354,30	2400	1
<b>B</b> 69173	418,80	3150	1

Ref	Tensión/Voltage	Potencia/Power	Lámp./Lamps	Parrilla/Grill	Dimensiones/Sizes	Peso/Weight
69172	220-240 V; 50/60 Hz	2400 W	6 (3 + 3)	40x24 cm	50x25x28 cm	7,10 Kg
69173	220-240 V; 50/60 Hz	3150 W	9 (3 + 3 + 3)	40x24 cm	50x25x38cm	9,20 Kg



**Ranuras de grandes dimensiones**  
Huge slots for toasting

**Bandeja recogemigas**  
Crumbs tray

## Tostadora buffet inox 4-6 ranuras

Grille-pain buffet pour 4-6 tranches  
Buffet-Toaster für 4-6 Brotscheiben  
4-6 slots st steel buffet toaster  
Torradeira buffet 4-6 fatias de pão

Ref	€	Ranuras	U.Venta
<b>A</b> 69294	230,70	4	1
<b>B</b> 69296	306,40	6	1

Ref	Tensión/Voltage	Potencia/Power	Selector/Selector	Ranuras/Slots	Dimensiones/Sizes	Peso/Weight
69294	220-240 V; 50/60 Hz	1800 W	2-4 ranuras · 2-4 groves	15x3 cm	29x26x22 cm	3,90 Kg
69296	220-240 V; 50/60 Hz	2500 W	2-4-6 ranuras · 2-4-6 groves	15x3 cm	42x26x22 cm	5,00 Kg

# Colección TOSTADORAS

Inox



· Household use ·



- Fabricadas en acero inoxidable de máxima calidad y resistencia. Muy robustas.
- Regulador giratorio: 6 niveles de tostado (uniforme y homogéneo).
- Pantalla Led: indica el tiempo restante del tostado.
- Tres funciones: descongelar, recalentar y cancelar.
- Ranuras extra anchas y rejilla para recalentar pan, bollería, etc.
- Bandeja recogemigas extraíble para facilitar su limpieza.
- Recoge cable manual.
- Pies de goma antideslizante para una máxima estabilidad.

- Fabriqués en acier inoxydable de la plus grande qualité et résistance. Très robustes.
- Régulateur giratoire : 6 niveaux de brunissage (uniforme et homogène).
- Écran Led : indique le temps restant.
- Trois fonctions : décongeler, griller et réchauffer.
- Rainures extra larges et grille pour réchauffer le pain, les viennoiseries, etc.
- Plateau ramasse-miettes extractible pour faciliter le nettoyage.
- Enrouleur de câble manuel.
- Pieds en caoutchouc antidérapants pour une stabilité maximale.

- Aus rostfreiem und widerstandsfähigem Edelstahl hergestellt. Sehr robust.
- Drehregler: 6 Röststufen (gleichmäßiges rösten).
- LED-Display: Mit Anzeige der verbleibenden Röstzeit.
- Drei Funktionen: Auftau- und Aufwärmfunktion, Abbrechknopf.
- Extra breite Röstkammern und Auflage zum Aufwärmen von Brötchen, Gebäck usw.
- Herausnehmbare Krumenwanne für leichte Reinigung.
- Manuelle Kabelaufnahme.
- Antirutschfüße aus Gummi für maximale Standfestigkeit.

- Made of top quality extremely tough stainless steel. Very strong.
- Rotating regulator: 6 toasting levels (even and homogeneous).
- LED Screen: shows the remaining toasting time.
- Three functions: defrost, cancel and reheat.
- Extra wide slots and a grill for reheating bread, pastries, etc.
- Removable crumb tray for easy cleaning.
- Manual cable retractor.
- Non-slip rubber feet for maximum stability.

- Fabricadas em aço inoxidável da máxima qualidade, robustas e resistentes.
- Regulador giratório com 6 níveis de tostagem (uniforme e homogénea).
- Ecrã LED, com indicação do tempo de tostagem restante.
- Três funções: descongelar, cancelar e reaquecer.
- Ranhuras extra largas e grelha para reaquecer o pão, pastelaria, etc.
- Bandeja recolhadora de migalhas extraível, para facilitar a sua limpeza.
- Recolhedor de cabo manual.
- Pés de borracha antideslizantes, para maior estabilidade.



**6 niveles de tostado**  
6 levels of toasting



**Incluye rejilla**  
Includes grid



**Bandeja recogemigas**  
Crumb tray



**3 funciones**  
3 functions



**Pantalla LED**  
LED display



## Tostadora SMART

Grille-pain  
Toaster  
Toaster  
Torradeira

	Ref	€	W	U.Venta)
<b>A</b>	69440	72,90	1500	1
<b>B</b>	69442	62,10	800	1
<b>C</b>	69444	87,50	1750	1

Ref	Tensión/Voltage	Potencia/Power	Ranuras/Slots	D. ranuras/Slots sizes	Dimensiones/Sizes	Peso/Weight
69440	220-240 V; 50/60 Hz	1500 W	2	3,8x25 cm	40,3x17,8x19 cm	2,40 Kg
69442	220-240 V; 50/60 Hz	800 W	2	3,8x14 cm	29,3x17,7x19 cm	1,65 Kg
69444	220-240 V; 50/60 Hz	1750 W	4	3,8x14 cm	28,8x31,5x19 cm	2,80 Kg



**7 posiciones de calentamiento, tostado uniforme en ambos lados**  
7 heating positions, uniform toast on both sides

**Ranuras de grandes dimensiones**  
Big slots for toasting



**Bandeja recogemigas**  
Crumbs tray

- Fabricada en acero inoxidable.
- Ranuras de grandes dimensiones (4x14 cm) para tostar cualquier tipo de pan.
- Permite tostar el pan de forma rápida, sencilla, sin ensuciar y sin necesidad de añadir grasa alguna.
- Funciones disponibles: tostar, descongelar, calentar.
- Selección del grado de tueste deseado en progresión continua (REHEAT · BAGEL · NORMAL · CANCEL).
- Expulsión automática.
- Bandeja recogemigas.
- Patas de apoyo antideslizantes.

- Fabriqué en acier inoxydable.
- Fentes de grandes dimensions (4x14 cm) pour faire griller tout type de pain.
- Il permet de faire griller le pain de manière rapide, simple, proprement et sans avoir besoin d'ajouter tous types de matières grasses.
- Fonctions disponibles : griller, décongeler, chauffer.
- Sélection du niveau de cuisson souhaité en progression continue (REHEAT · BAGEL · NORMAL · CANCEL).
- Éjection automatique.
- Tiroir ramasse-miettes.
- Pieds de soutien antidérapants.

- Made of Stainless Steel.
- Large 4 x 14 cm slots for toasting all kinds of bread.
- You can toast bread quickly, easily, without making a mess and without having to use any extra fat.
- Functions: toast, defrost, heat.
- Choose the toasting darkness along a sliding scale (REHEAT · BAGEL · NORMAL · CANCEL).
- Automatic ejection.
- Crumb Tray.
- Non-slip feet.

## Tostadora CURVE

Grille-pain  
Toaster  
Toaster  
Torradeira

	Ref	€	W	U.Venta
A	69062	51,80	1000	1
B	69064	78,00	1750	1

Ref	Tensión/Voltage	Potencia/Power	Selector/Selector	Ranuras/Slots	Dimensiones/Sizes	Peso/Weight
69062	220-240 V; 50/60 Hz	1000 W	2 ranuras · 2 slots	14x4 cm	19x29x19 cm	1,40 Kg
69064	220-240 V; 50/60 Hz	1750 W	2-4 ranuras · 2-4 slots	14x4 cm	33x29x19cm	3,10 Kg

**A**  
Inox  
18/10



**B**



- Gracias a su diseño y área de calentamiento podrá tostar todo tipo de panes o bollería y varias rebanadas a la vez.
- Grâce à sa conception et sa zone de chauffe, vous pourrez griller tout type de pains ou de viennoiseries et plusieurs tranches à la fois.
- Dank des Designs und des Erwärmungsbereichs können Sie alle möglichen Brotsorten und mehrere Scheiben gleichzeitig tosten.
- Thanks to its design and heating area you will be able to toast all types of bread and pastries, and several slices at a time.
- Graças ao seu desenho e área de aquecimento, poderá tostar todo o tipo de pães ou bolos, e várias fatias ao mesmo tempo.



**6 posiciones de calentamiento**  
6 heating positions



**Aviso sonoro**  
Alarm



**Bandeja recogemigas**  
Crumbs tray

## Tostadora horizontal

Toaster horizontal  
Horizontal-/Toaster  
Electric toaster  
Torradeira horizontal

	Ref	€	W	U.Venta
A	69163	33,00	600	1 BASIC
B	69363	41,30	600	1 EASY

Ref	Tensión/Voltage	Potencia/Power	Temperatura/Temp.	Tostado/Toasted	Parrilla/Grill	Dimensiones/Sizes	Peso/Weight
69163	220-240 V; 50/60 Hz	600 W	360°C	6	25x20 cm	36x21x6,5 cm	1,00 Kg
69363	220-240 V; 50/60 Hz	600 W	360°C	6	25x20 cm	42x30x9 cm	1,00 Kg

# Tostadoras LONG & DUPLO



· Household use ·



- Permite tostar de forma rápida y sencilla, sin necesidad de añadir grasa alguna.
- Función de descongelación y cancelación.
- Regulador ajustable de tueste; elige entre 7 niveles para tostar a tu gusto.
- Ranura alargada para rebanadas extra largas o para más de una rebanada de pan.
- Parrilla adicional para calentar bollos o pan (69360).
- Incorpora una práctica bandeja, donde se depositan las migas.

- Permet de griller de façon rapide et simple sans nécessité d'ajouter aucune graisse.
- Fonction de décongélation et d'arrêt.
- Régulateur de brunissage réglable : choisissez parmi 7 niveaux pour griller selon vos souhaits.
- Rainure allongée pour des tranches extra larges ou pour plus d'une tranche de pain.
- Grille supplémentaire pour réchauffer des viennoiseries ou du pain (69360).
- Intègre un plateau pratique sur lequel se déposent les miettes.

- Für einfaches und schnelles Toasten ohne Fett.
- Mit Auftau- und Abbruchtaste.
- Einstellbarer Regler mit 7 Bräunungsstufen ganz nach dem eigenen Geschmack.
- Extra lange Röstkammer für eine große oder mehrere kleine Brotscheiben.
- Zusätzliches Rost zum Erwärmen von Brötchen oder Brot (69360).
- Mit praktischer Krumenwanne.

- Fast and easy toasting without the need to use any fatty products.
- Defrost and cancel functions.
- Adjustable darkness regulator. Choose from 7 levels for toasting as you like.
- Long slot for extra wide slices of bread or more than one slice of bread at once.
- Additional grill to heat buns or bread (69360).
- It has a practical tray for catching crumbs.

- Permite tostar de forma rápida e fácil, sem necessidade de acrescentar nenhum tipo de gordura.
- Função de descongelação e botão de cancelamento.
- Regulador de tostagem com 7 níveis diferentes, para o ajustar ao gosto pessoal.
- Ranhura longa para fatias extra longas, ou para mais do que uma fatia de pão.
- Grelha adicional para aquecer bolos ou pão (69360).
- Incorpora uma prática bandeja para recolher as migalhas.



**Termostato**  
7 posiciones de tostado  
Thermostat: 7 positions toasted



**Dispone de función descongelar**  
It has a defrost function



**Bandeja recogemigas**  
Crumb tray



**Patas de apoyo antideslizantes**  
Non-slip supports



**Ranura alargada de 25 x 4 cm**  
25x4 cm slot for extra wide slices



**Doble ranura**  
Double slot

Inox

## Tostadora LONG

Grille-pain  
Toaster  
Toaster  
Torradeira

Ref	€	W	U.Venta
69260	61,80	1500	1

**Ranura alargada de 24,5 x 4 cm**  
24,5 x 4 cm slot for extra wide slices



**Doble ranura**  
Double slot

Inox  
18/10

## Tostadora DUPLO

Grille-pain  
Toaster  
Toaster  
Torradeira

Ref	€	W	U.Venta
69360	63,70	1000	1

Ref	Tensión/Voltage	Potencia/Power	Selector/Selector	Dimensiones/Sizes	Peso/Weight
69260	220-240 V; 50/60 Hz	1500 W	<b>Dos ranuras</b> · Two slots	39x15,2x20,5 cm	2,40 Kg
69360	220-240 V; 50/60 Hz	1000 W	<b>Una ranura</b> · One slot	41x12x18,5 cm	1,40 Kg

# Exprimidores PROFESIONALES



· Professional use ·



**Contenedor y cono de acero inoxidable**  
Container and cone of stainless steel



- Cuenta con una potencia de 230 W y materiales de gran calidad para que puedas exprimir todo tipo de frutas y cítricos.
- Sistema de puesta en marcha automático al presionar la palanca.
- Cono de acero inoxidable extraíble, apto para el lavavajillas hasta 90°C.
- Tiempo máximo en funcionamiento continuo: 30 minutos.

- Il possède une puissance de 230 W et des matériaux de grande qualité pour presser tout type de fruits et d'agrumes.
- Système de mise en marche automatique en appuyant sur le levier.
- Amovible cône en acier inoxydable, au lave-vaisselle jusqu'à 90°C.
- Temps de fonctionnement continu maximale: 30 minutes.

- Sie bringt eine Leistung von 230 W und besteht aus hochwertigen Materialien, damit Sie alle Arten von Obst und Zitrusfrüchten auspressen können.
- Automatisches Startsystem bei Drücken des Hebels.
- Abnehmbarer Edelstahl Kegel, spülmaschinenfest bis 90°C.
- Maximale Dauerbetriebszeit: 30 Minuten.

- It has 230 W power and is made from high quality materials so you can make juice from all types of fruits and citric fruits.
- Automatic starting when pressing the lever.
- Removable stainless steel cone, suitable to dishwasher up to 90°C.
- Maximum continuous operating time: 30 minutes.

- Com uma potência de 230 W e fabricado com materiais de grande qualidade, para que possa espremer todo o tipo de frutas e de cítricos.
- Sistema de posta em funcionamento automático ao pressionar a alavanca.
- Cone de aço inoxidável removível, laváveis até 90°C.
- Tempo máximo de funcionamento contínuo: 30 minutos.

**Robusto bloque de aluminio fundido**  
Robust aluminium block

**AL**  
Aluminium  
Cuerpo/Corp

**Inox**  
18/10

## Exprimidor profesional INOX

Presse-fruits professionnelle  
Profi-Zitruspresse  
Professional squeezer  
Espremedor professional

Ref	€	W	U.Venta
69283	435,30	230	1

Ref	Tensión/Voltage	Potencia/Power	Velocidad/Speed	Dimensiones/Sizes	Peso/Weight
69283	220-240 V; 50/60 Hz	230 W	980 r.p.m.	28x20x40 cm	10,50 Kg



**Protector de salpicaduras**  
Comes with a splash guard



- Ideal para uso profesional intensivo por su potencia y velocidad, permite extraer el zumo con gran rapidez y sin esfuerzo.
- Constituido por un robusto bloque de hierro fundido.
- 3 conos diferentes, lo que permite obtener el máximo rendimiento de diferentes tipos de cítricos.
- El funcionamiento es muy sencillo: póngalo en marcha con el interruptor de encendido/apagado, coloque un vaso bajo la boquilla y presione las naranjas sobre el cono.
- Un colador separa la pulpa y vierte el zumo a través de la boquilla de salida.
- Incluye protector antisalpicaduras.

- Idéale pour un usage professionnel intensif grâce à sa puissance et sa vitesse, qui permettent d'extraire le jus très rapidement et sans efforts.
- Composée d'un bloc en fonte robuste.
- 3 cônes différents, ce qui permet d'obtenir le rendement maximum de différents types d'agrumes.
- Le fonctionnement est très simple : mettre la machine en marche à l'aide de l'interrupteur de marche/arrêt, placer un verre sous le bec et presser les oranges sur le cône.
- Un filtre sépare la pulpe et verse le jus à travers le bec de sortie.
- Inclut une protection anti-éclaboussures.

- Perfect for intensive professional use thanks to its power and speed, allowing you to quickly and effortlessly extract juice.
- Comprised of a robust cast iron body.
- 3 different cones, giving you optimal performance for different citrus fruits.
- Simple to use: press the on/off button, place a glass beneath the nozzle and squeeze the oranges on the cone.
- A sieve filters the pulp and the juice pours out of the nozzle.
- Includes an anti-splash protector.

**Fe**  
Hierro/Iron

**AS**  
Plastic  
Tapa/Lid

## Exprimidor profesional BLACK

Presse-fruits professionnelle  
Profi-Zitruspresse  
Professional squeezer  
Espremedor professional

Ref	€	W	U.Venta
69286	218,40	180	1

Ref	Tensión/Voltage	Potencia/Power	Velocidad/Speed	Dimensiones/Sizes	Peso/Weight
69286	220-240 V; 50/60 Hz	180 W	1.350 r.p.m.	31x22x35 cm	4,80 Kg



# Colección **EXPRIMIDORES DE ZUMO**



· Household use ·



- **Exprimidor robusto, seguro y eficiente, aprovecha todo el zumo de los cítricos sin esfuerzo.**
- **Cuerpo fabricado en acero inoxidable pintado en color blanco.**
- **Palanca ergonómica para un mejor agarre y un menor esfuerzo.**
- **Mecanismo potente capaz de exprimir los cítricos sin detenerse y sin pérdidas de potencia.**
- **Sistema de puesta en marcha automática al presionar la palanca, mantenga una presión suave hasta extraer todo el zumo.**
- **Sistema de bloqueo de salida de zumo y antigoteo.**
- **100% estable: base con 4 ventosas.**
- **Fácil de limpiar. Accesorios desmontables y aptos para el lavavajillas.**

- Presse-fruits robuste, sûr et efficace, il presse tout le jus des agrumes sans efforts.
- Corps fabriqué en acier inoxydable peint en blanc.
- Levier ergonomique pour une meilleure prise en main et moins d'efforts.
- Mécanisme puissant capable de presser les agrumes sans s'arrêter et sans perte de puissance.
- Système de mise en marche automatique en appuyant sur le levier, maintenir une pression légère jusqu'à presser tout le jus.
- Système de blocage de la sortie du jus et système anti-goutte.
- 100% stable : base dotée de 4 ventouses
- Facile à nettoyer. Accessoires démontables et compatibles lave-vaisselle.

- Zitruspresse Ergiebige, sichere und robuste Saftpresse für Orangen, Zitronen usw.
- Edelstahlmantel in Weiß.
- Ergonomischer Hebel für besseren Halt und weniger Kraftaufwand.
- Leistungsstarke Zitruspresse drückt den Saft in einem Arbeitsgang restlos aus.
- Mit Hebel gekoppelter Betrieb läuft automatisch an - bei leicht gedrücktem Hebel wird aller Saft ausgepresst.
- Läuft nicht über, tropft nicht.
- 4 Saugfüße sorgen für 100 % Standfestigkeit.
- Leichte Reinigung. Zubehör abnehmbar und spülmaschinengeeignet.

- Strong, safe and efficient squeezer, so that you can effortlessly enjoy all citrus fruit juices.
- Stainless steel body painted in white.
- Ergonomic lever for better grip and minimal effort.
- Powerful mechanism capable of juicing citrus fruits without pausing and without loss of power.
- Automatic start-up upon pressing the lever, keep a light pressure until all juice is extracted.
- Juice output blocking and anti-drip system.
- 100% stable: its base has 4 suction cups for maximum stability.
- Easy to clean. Detachable, dishwasher-safe accessories.



- **Exprimedor robusto, seguro e eficiente. Aproveita todo o sumo dos cítricos sem esforço.**
- **Corpo fabricado em aço inoxidável pintado de cor branca.**
- **Alavanca ergonómica, para melhor sujeição e menor esforço.**
- **Mecanismo potente, capaz de espremer os cítricos sem se deter, e sem perdas de potência.**
- **Sistema de posta em funcionamento automático, bastando acionar a alavanca mantendo uma pressão suave até extrair todo o sumo.**
- **Sistema de bloqueio de saída do sumo e anti-gotejamento.**
- **100% estável: base com 4 ventosas.**
- **Fácil de limpar. Acessórios desmontáveis e aptos para máquinas de lavar louça.**



**Puesta en marcha automática al presionar la palanca**  
Automatic start-up upon pressing the lever



**Dos conos para todo tipo de cítricos**  
Two cones for all kinds of citrus



**Sist. de bloqueo de salida de zumo y antigoteo**  
Anti-drip and juice outlet blockage system

## Exprimidor de palanca VITALLY

Presse-fruit  
Zitruspresse  
Orange squeezer  
Espremedor de sumos

	Ref	€	W	Color	U.Venta
<b>A</b>	69120	94,20	160	INOX	1
<b>B</b>	69231	126,40	160	WHITE	1

*new*

Ref	Tensión/Voltage	Potencia/Power	Dimensiones/Sizes	Peso/Weight
69120	220-240 V; 50/60 Hz	160 W	19,5x29x29 cm	2,50 Kg
69231	220-240 V; 50/60 Hz	160 W	19,5x29x29 cm	2,50 Kg



**Puesta en marcha automática al presionar la palanca**  
Automatic start-up upon pressing the lever



**Dos conos para todo tipo de cítricos**  
Two cones for all kinds of citrus



**Sist. de bloqueo de salida de zumo y antigoteo**  
Anti-drip and juice outlet blockage system



## Exprimidor de palanca ENERGY

Presse-fruit  
Zitruspresse  
Orange squeezer  
Espremedor de sumos

Ref	€	W	U.Venta
69285	66,10	100	1

Ref	Tensión/Voltage	Potencia/Power	Dimensiones/Sizes	Peso/Weight
69285	220-240 V; 50 Hz	100 W	Ø20x29 cm	1,75 Kg



**Accionamiento y puesta en marcha presionando el cono hacia abajo**  
Activate just by pressing the cone downwards



**Sist. de bloqueo de salida de zumo y antigoteo**  
Anti-drip and juice outlet blockage system

**A**



**B**



## Exprimidor de zumos

Presse-fruit  
Zitruspresse  
Orange squeezer  
Espremedor de sumos

	Ref	€	W	U.Venta	
<b>A</b>	69287	66,80	100	1	SPIRIT
<b>B</b>	69280	54,80	100	1	POWER

Ref	Tensión/Voltage	Potencia/Power	Dimensiones/Sizes	Peso/Weight
69287	220-240 V; 50/60 Hz	100 W	18x16,5x25 cm	1,90 Kg
69280	220-240 V; 50/60 Hz	100 W	Ø14,5x25 cm	1,68 Kg



**Accionamiento y puesta en marcha presionando el cono hacia abajo**  
Activate just by pressing the cone downwards



**Dos conos para todo tipo de cítricos**  
Two cones for all kinds of citrus



**Sistema de pulpa regulable**  
Adjustable pulp system

**Jarra extraíble graduada de 750 ml/26 onzas**  
Removable 750ml/26oz capacity measuring jug

**Rotación automática en ambos sentidos**

Automatic rotation in both directions:



## Exprimidor de zumos ZITRUS

Presse-fruit  
Zitruspresse  
Orange squeezer  
Espremedor de sumos

Ref	€	W	L	U.Venta
69575	23,80	40	0,75	1



Ref	Tensión/Voltage	Potencia/Power	Capacidad/Capacity	Dimensiones/Sizes	Peso/Weight
69575	220-240 V; 50/60 Hz	40 W	750 ml (26 oz)	Ø19x20,5 cm	0,820 Kg

# Exprimidor AUTOMÁTICO

ABS

AS

Plastic



AC



plastic

Tapa/Lid

Household use



- Exprimidor totalmente automático, gracias a su innovadora tecnología la fruta se exprime pulsando solo un botón.
- Mecanismo muy eficaz que exprime hasta la última gota del jugo de frutas.
- Gracias a su innovadora tecnología, no es necesario controlar la preparación del zumo.
- Cono universal que exprime sin problemas el jugo de los pomelos, naranjas, limones o limas.
- Sistema de bloqueo de salida de zumo y protección antigoteo.
- Sin salpicaduras durante el funcionamiento gracias a su tapa cerrada.
- Patas de goma antideslizantes.
- Todas las piezas son desmontables para una fácil limpieza y aptas para lavavajillas.

- Presse-agrumes entièrement automatique ; les fruits sont pressés en appuyant sur un bouton.
- Mécanisme puissant qui presse jusqu'à la dernière goutte du jus des fruits.
- Grâce à sa technologie innovante, il n'est pas nécessaire de surveiller la préparation du jus.
- Cône universel qui presse sans problèmes le jus des pamplemousses, oranges, citrons ou citrons verts.
- Système de blocage de sortie et protection anti-goutte.
- Sans éclaboussures pendant le fonctionnement grâce à son couvercle fermé.
- Pieds en caoutchouc antidérapants.
- Toutes les pièces sont démontables pour un nettoyage facile, et aptes pour le lave-vaisselle.

- Vollkommen automatische Saftpresse für Saft auf Knopfdruck.
- Leistungsfähige Mechanik presst Fruchtsaft bis auf den letzten Tropfen aus.
- Innovative Technik bereitet den Saft von allein und ohne Zutun.
- Universeller Presskegel für Grapefruit, Orangen, Zitronen oder Limetten.
- Mit Überlauf- und Tropfschutz.
- Betrieb mit geschlossenem Deckel, sodass nichts heraus spritzt.
- Rutschfeste Standfüße.
- Einfache Reinigung: alle Teile sind abnehmbar und spülmaschinengeeignet.

- This totally automatic juicer squeezes fruit with the touch of a button.
- It's powerful mechanism squeezes out the last drop of fruit juice.
- Thanks to its innovative technology, you don't have to watch whether it makes the juice.
- The universal cone easily squeezes juice from grapefruit, oranges, lemons and limes.
- It has a system for juice outlet blocking and drip protection.
- It doesn't splash while running thanks to its closed lid.
- Non-slip rubber feet.
- All the parts are removable for easy cleaning and they're also dishwasher safe.

- Espremedor totalmente automático – extrai o sumo da fruta com um simples toque no botão.
- Mecanismo potente, que espreme até à última gota do sumo da fruta.
- Graças à sua inovadora tecnologia, não é necessário estar pendente da extração do sumo.
- Cone universal, que permite espremer facilmente o sumo de pomelos, laranjas, limões e limas.
- Sistema de bloqueio de saída do sumo e proteção anti-gotejamento.
- A sua tampa evita as salpicaduras durante o funcionamento.
- Patas de borracha antideslizantes.
- Todas as peças são desmontáveis para facilitar a sua limpeza, e aptas para máquinas de lavar louça.



## Exprimidor automático

Presse-agrumes automatique

Automatische Saftpresse

Automatic juicer

Espremedor automático

Ref	€	W	ml	U.Venta
69520	82,60	60	400	1

Ref	Tensión/Voltage	Potencia/Power	Capacidad/Capacity	Dimensiones/Sizes	Peso/Weight
69520	220-240 V; 50/60 Hz	60 W	400 ml	20x19x31 cm	1,75 Kg

# Colección LICUADORAS



· Professional use ·

Los residuos son recogidos automáticamente

The residues are automatically collected



- Fabricada en acero inoxidable de alta calidad muy robustas y potentes.
- Diseñada para uso continuo.
- Su potente motor, su gran velocidad y su gran orificio de entrada permiten preparar de forma rápida nutritivos zumos de frutas o verduras con expulsión automática de la pulpa.
- Contenedor de residuos de gran tamaño.
- Mecanismo de cierre con interruptor de seguridad.
- Filtro microperforado de acero inoxidable.
- Componentes desmontables, fáciles de limpiar.

- Fabriquée en acier inoxydable de grande qualité, très robuste et puissante. Conçue pour un usage continu.
- Son puissant moteur, sa grande vitesse et son large orifice d'entrée permettent de préparer rapidement des jus de fruits ou de légumes nutritifs avec une expulsion automatique de la pulpe.
- Conteneur de déchets de grande contenance.
- Mécanisme de fermeture avec interrupteur de sécurité.
- Filtre micro-perforé en acier inoxydable.
- Composants démontables, faciles à nettoyer.

- Extremely robust and powerful blender made of high quality stainless steel. Designed for continuous use.
- With its powerful motor, high speed, extra large opening and automatic pulp expulsion you can make nutritious fruit or vegetable juice quickly.
- Large waste container.
- Closing mechanism with a safety switch.
- Stainless steel micro-perforated filter.
- Easy to clean removable components.



## Licuadora profesional PRO

Centrifugeuse professionnel  
 Professioneller zitrus entsafter  
 Professional juice extractor  
 Liquidificador profesional

Ref	€	W	Kg/h	U.Venta
69488	1.139,10	700	120	1

Ref	Tensión/Voltage	Potencia/Power	Par mot./M. torque	Conten. residuos/Waste container	Ø Entrada/Entry	Dimensiones/Sizes	Peso/Weight
69488	220-240 V; 50 Hz	700 W	2,9 Nm	6,0 L	9 cm	47,3x25,3x52,2 cm	13,20 Kg

· Household use ·

Los residuos son recogidos automáticamente

The residues are automatically collected



- Fabricada en acero inoxidable de alta calidad muy robusta y potente.
- Diseñada para uso continuo.
- Su potente motor, su gran velocidad y su gran orificio de entrada permiten preparar de forma rápida nutritivos zumos de frutas o verduras con expulsión automática de la pulpa.
- Contenedor de residuos de gran tamaño.
- Mecanismo de cierre con interruptor de seguridad.
- Filtro microperforado de acero inoxidable.
- Componentes desmontables, fáciles de limpiar.

- Fabriquée en acier inoxydable de grande qualité, très robuste et puissante. Conçue pour un usage continu.
- Son puissant moteur, sa grande vitesse et son large orifice d'entrée permettent de préparer rapidement des jus de fruits ou de légumes nutritifs avec une expulsion automatique de la pulpe.
- Conteneur de déchets de grande contenance.
- Mécanisme de fermeture avec interrupteur de sécurité.
- Filtre micro-perforé en acier inoxydable.
- Composants démontables, faciles à nettoyer.

- Extremely robust and powerful blender made of high quality stainless steel. Designed for continuous use.
- With its powerful motor, high speed, extra large opening and automatic pulp expulsion you can make nutritious fruit or vegetable juice quickly.
- Large waste container.
- Closing mechanism with a safety switch.
- Stainless steel micro-perforated filter.
- Easy to clean removable components.



## Licuadora NUTRITY

Fruit centrifugeuse  
 Zitrus entsafter  
 Juice extractor  
 Liquidificador de sumos

Ref	€	W	L	U.Venta
69288	97,50	850	1,0	1

Ref	Tensión/Voltage	Potencia/Power	Par mot./M. torque	Cap.Capacity	Cont/ Container	Ø Entrada/Entry	Dimensiones/Sizes	Peso/Weight
69288	220-240 V; 50 Hz	850W	0,387 Nm	1,00 L	2,0 L	7,5 cm	30x20x36 cm	4,10 Kg



Incluye **RECETARIO**  
RECIPE BOOK included

· Household use ·

**Exprime frutas y verduras enteras**  
Whole fruit / vegetables

**Bloqueo de salida**  
Juice stopper



- Tecnología "SLOW": Mediante el sistema de rotación lenta y el método de prensado en frío, permite obtener todos los nutrientes de frutas y verduras a diferencia de los exprimidores tradicionales. Ultrasilencioso gracias a su motor de bajas revoluciones.
- Mezcla frutas y verduras en el interior del recipiente antes de verterlo en la jarra.
- Introduce los ingredientes enteros permitiendo acelerar el tiempo dedicado a la extracción del zumo.
- Fácil limpieza. Cepillo para limpiar las partes internas. Accesorios aptos para el lavavajillas.

- Technologie "LENTE". Par son Systeme de rotation lente et la méthode de pression, cela permet de récupérer le maximum des ingrédients du fruit et légume à la différence des presses fruits traditionnels. Ultra silencieux. Grace à son moteur à basse tours.
- Capuchon à jus permettant de mélanger les fruits et légumes à l'intérieur du récipient avant de les verser dans les pichets.
- Introduire entièrement les fruits et légumes, gain de temps.
- Facile à nettoyer. Brosse fournit. Accessoires compatibles lave vaisselle.

- "SLOW" Rotation Engine. The slow rotation system facilitates a cold squeeze that allows the juice preserve all the nutritional properties from vegetables and fruits, unlike traditional squeezers. Ultra-silent. It's engine works in silence and eliminates unnecessary noise.
- Mixes all the desired fruits and vegetables inside the container before serving.
- The slow juicer lets you work with whole fruits and big pieces of vegetables.
- Easy cleaning. A brush incorporated for the inner parts. All pieces are dishwasher compatible.

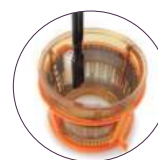

## Licuada ECOLO

Fruit centrifugeuse  
Zitrus entsafter  
Juice extractor  
Liquidificador de sumos

Ref	€	W	U.Venta
69373	411,20	240	1

Ref	Tensión/Voltage	Potencia/Power	Velocidad/Speed	Capacidad/Capacity	Dimensiones/Sizes	Peso/Weight
69373	230 V; 50/60 Hz	240 W	60 r.p.m	1,0 L	29x20x44 cm	7,30 Kg

## Procesador de alimentos SOAK

Inox  

· Household use ·



**Jarra de acero inoxidable**  
Stainless steel jug

**4 cuchillas**  
4 blades

- Cocine sopas caseras, salsas, purés, cremas, batidos, zumos, cócteles, etc.
- Saltear ingredientes, cocinar a fuego lento o hervir sopas.
- Mezcla los ingredientes durante el proceso de cocción.
- Pica hielo en menos de 50 segundos y mezcla desde batidos hasta cócteles congelados.

- Cuisinez des soupes maison, des sauces, des purées, des crèmes, des milk-shakes, des jus de fruit, des cocktails, etc
- Sauter les ingrédients, cuisiner à feu doux ou faire bouillir des soupes.
- Mélange les ingrédients pendant le processus de cuisson.
- Pile la glace en moins de 50 secondes et mélange aussi bien des milk-shakes que des cocktails congelés.

- Bereiten Sie hausgemachte Suppen, Püree, Cremes, Shakes, Säfte, Cocktails usw. zu.
- Anbraten von Zutaten, langsamen Kochen oder Brühen von Suppen.
- Die Zutaten werden während des Kochvorgangs gemischt.
- Eis wird in unter 50 Sekunden zerkleinert und es werden Shakes und sogar gefrorene Cocktails gemischt.

- Prepare home-made soups, sauces, purées, creams, milkshakes, juices, cocktails, etc.
- Sautéing ingredients, cooking at low heat or boiling soups.
- Mixes the ingredients during the cooking process.
- Crushes ice in under 50 seconds and mixes anything from milkshakes to frozen cocktails.

- Elabore sopas caseiras, molhos, purés, cremas, batidos, sumos, cocktails, etc.
- Saltear ingredientes, cozinhar a fogo lento ou ferver sopas.
- Misturando os ingredientes durante o processo de cocção.
- Pica gelo em menos de 50 segundos, e mistura desde batidos até cocktails congelados.

## Procesador de alimentos SOAK

Robot culinaire  
Küchenmaschine  
Food processor  
Processador de alimentos

Ref	€	W	L	U.Venta
69380	208,50	450	1,7	1

Ref	Tensión/Voltage	Potencia/Power	Calentamiento/Heating	Velocidad/Speed	Capacidad/Capacity	Dimensiones/Sizes	Peso/Weight
69380	220-240 V; 50/60 Hz	450 W	700 - 900 W	17.000 r.p.m.	1,70 L	25x21x45 cm	2,40 Kg

# Batidoras personales PRO & MIX&GO



· Household use ·



**tritan™**  
**BPA free**  
Dishwasher safe

- Elabora sin esfuerzo batidos, cremas y zumos de fruta y verdura en segundos.
- Dispone de un potente motor de 1200 W diseñado para batir con facilidad (69389).
- Protección contra sobrecalentamiento.
- Las cuchillas de acero inoxidable pulverizan las semillas, cortan las pieles y trituran las partes densas y fibrosas de los alimentos hasta el punto de mantener la máxima cantidad de nutrientes.
- Funcionamiento muy sencillo, solo hay que presionar la jarra para que el motor active las cuchillas (69389).
- Incluye dos jarras de tritán libres de BPA (69389 - 1 L / 0,5 L) / (69382 - 600 ml / 300 ml), dos tapas y un asa que se acopla a los vasos para facilitar su agarre (69389).

- Qui prépare sans efforts des smoothies, des crèmes et des jus de fruits et de légumes en quelques secondes.
- Dispose d'un puissant moteur de 1200 W conçu pour battre facilement (69389).
- Protection contre la surchauffe.
- Les lames en acier inoxydable pulvérisent les graines, coupent les peaux et triturent les parties denses et fibreuses des aliments afin de maintenir une quantité de nutriments maximale.
- Fonctionnement très simple, il suffit d'exercer une pression le bol pour que le moteur active les lames (69389).
- Inclut deux bols en tritan sans BPA (69389 - 1 L / 0,5 L) / (69382 - 600 ml / 300 ml), deux couvercles et une poignée qui s'emboîte aux bols pour faciliter leur prise en main (69389).

- High quality blender, effortlessly prepares shakes, creams, and fruit and vegetables juices in seconds.
- Equipped with a powerful 1200 W motor designed for easy blending (69389).
- Overheating protection.
- Stainless steel blades grind seeds, cut skins, and purée dense, fibrous parts of the food to the point of maintaining the maximum amount of nutrients.
- Very easy to operate. Just press the pitcher to activate the blades of the motor (69389).
- Includes two (69389 - 1 L / 0,5 L) / (69382 - 600 ml / 300 ml) BPA free blender pitchers, two lids, and a handle that attaches to the cups for easy handling (69389).



2 jarras tritán (0,5/1 L)  
Two tritan pitchers (0,5/1 L)

Inox

## Batidora personal PRO

Mixeur personnel  
Mini-Standmixer  
Individual blender  
Batadeira pessoal

Ref	€	W	L	U.Venta
69389	99,90	1200	0,5 / 1,0	1



## Batidora personal MIX & GO

Personnelle mixeur  
Personliche mixer  
Personal blender  
Misturador pessoal

Ref	€	W	ml	U.Venta
69382	50,00	350	600/300	1

Ref	Tensión/Voltage	Potencia/Power	Jarras/Pitchers	Jarra pequeña Small jug	Jarra grande Big jug	Dimensiones/Sizes	Peso/Weight
69389	220-240 V ; 50/60 Hz	1200 W	2	0,5 L	1,0 L	14x14x40,5 cm	2,40 Kg
69382	220-240 V ; 50/60 Hz	350 W	2	0,3 L	0,6 L	12x12x40,5 cm	1,05 Kg

# Batidora personal MIX & GO con jarra



· Household use ·



- Ideal para preparar pequeñas cantidades de cremas, batidos y zumos de fruta y verdura al instante.
- Compacta y de gran potencia (350 W), dispone de 4 cuchillas de acero inoxidable especiales para triturar hielo y moler semillas, frutos secos, cereales y café.
- Permite preparar y transportarlo en el mismo recipiente gracias a su jarra-vaso portátil.
- Idéal pour préparer instantanément de petites quantités de crèmes, milk-shakes et jus de fruits et légumes.
- Compact et d'une grande puissance (350 W), il dispose de 4 lames en acier inoxydable spéciales pour piler la glace et mouliner les graines, les fruits secs, les céréales et le café.
- Permet de préparer et de transporter les préparations dans le même récipient grâce à son pichet/verre portable.
- Ideal für die schnelle Zubereitung von Cremes, Shakes und Säften aus Obst und Gemüse in kleinen Mengen.
- Platzsparend und leistungsstark (350W) mit 4 rostfreien Spezialmessern zum Zerkleinern von Eis und Mahlen von Samen, Trockenobst, Getreide und Kaffee.
- Zubereitung und Transport im selben Behälter, dank tragbarem und dicht verschließbarem Glaskrug.
- Ideal for preparing small quantities of creams, smoothies and fruit and vegetable juices instantly.
- Compact and powerful (350 W), it has 4 special stainless steel blades for crushing ice and grinding seeds, nuts, cereals and coffee.
- Enables you to prepare and transport your juices or smoothies in the same container thanks to its portable.
- Ideal para preparar pequenas quantidades de cremes, batidos e sumos de frutas e verduras num instante.
- Compacta e potente (350 W), com 4 lâminas de aço inoxidável especiais para triturar gelo e moer sementes, frutos secos, cereais e café.
- Permite preparar e transportar os alimentos processados no mesmo recipiente, graças ao seu jarro-vaso portátil.

Jarra de vidrio templado (500 ml)  
High quality toughened glass (500 ml)



Incluye 4 pajitas desechables de papel ecológico  
Includes 4 disposable straws made from eco-friendly paper

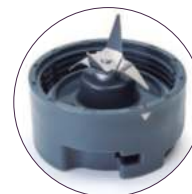

**Cuchillas de acero inoxidable especiales para triturar hielo y moler semillas, frutos secos, cereales y café**  
Special stainless steel blades for crushing ice and grind seeds, nuts, cereals and coffee



**Jarra de vidrio templado de gran grosor, alta calidad, duradera y resistente. Apta para el lavavajillas**  
Durable, sturdy jug made from very thick, high quality toughened glass. Dishwasher safe



**Tapa de metal con rosca**  
Metal lid with screw cap

## Batidora personal MIX & GO con jarra de cristal

Mixeur personnel MIX & GO avec bol en verre  
Mini-Standmixer MIX & GO mit Glasbehälter  
MIX & GO individual blender with glass jug  
Batedeira pessoal MIX & GO com jarra de vidro

Ref	€	W	L	U.Venta
69386	46,60	350	0,50	1

Ref	Tensión/Voltage	Potencia/Power	Capacidad/Capacity	Altura jarra/Height jar	Dimensiones/Sizes	Peso/Weight
69386	220-240 V; 50/60 Hz	350 W	500 ml	23 cm	Ø12 x 31 cm	1,50 Kg

## Accesorios

Accessoires · Zubehör · Accessories · Acessórios

**Tapa de metal con orificio central para introducir la pajita**  
Metal lid with central hole for straw insertion



**Gran grosor, alta calidad, duradera y resistente**  
Very thick, high quality toughened glass

**Apta para la batidora 69386/69382**  
Suitable for blender 69386/69382



**Incluye 2 tapas**  
Includes 2 caps

**Incluye 4 pajitas de papel ecológico**  
Includes 4 eco-friendly straws

**Cristal**

Glass

### Set 2 jarras de cristal

Set de 2 pichets en verre  
2er-Set Glasbehälter  
Set of 2 glass pitchers  
Conjunto de 2 jarras de vidrio

Ref	€	ml	U.Venta
69387	19,10	500	1

**Certificación FDA, apta para el uso alimenticio**  
FDA certified, suitable for use with food

**Biodegradables**  
Biodegradable

**Muy resistentes**  
Very resistant



**No se deforman ni transmiten ningún sabor**  
They don't distort or transfer any flavour

### Set 50 pajitas de papel ecológicas

Set de 50 pailles en papier écologiques  
Papierstrohhalm umweltfreundlich 50-er-Set  
Set of 50 eco-friendly paper straws  
Conjunto de 50 palhinhas de papel Ecológicas

Ref	€	Ø (mm)	h (cm)	e (mm)	g/mm2	U.Venta
69339	4,80	6	23	0,3	310	1

**INOX:** Pajitas reutilizables de acero inoxidable de gran calidad. No se oxidan, agrietan, rayan o rompen. La referencia 63132 destaca por su elegante acabado en color cobre. La mejor alternativa a las pajitas de plástico de un solo uso. Ecológicas, respetuosas con el medio ambiente. Incluye cepillo para facilitar la limpieza. Aptas para el lavavajillas.

**CRISTAL:** Fabricadas en cristal borosilicato de máxima calidad, resistente a los golpes. Extremadamente duraderas y seguras de usar. Esquinas redondeadas. Reutilizables, higiénicas y ecológicas. Fácil limpieza. Incluye cepillo. Aptas para el lavavajillas.

**INOX:** High quality reusable stainless steel straws. They don't rust, crack, scratch or break. Reference 63132 stand out thanks to their elegant finish in copper color. The ideal alternative to single-use plastic straws. Environmentally friendly. Comes with a brush for easy cleaning. Dishwasher safe.

**GLASS:** Made of high-quality impact-resistant borosilicate glass. Extremely durable and safe to use. Rounded corners. Reusable, hygienic, and ecological. Easy cleaning. Includes brush. Dishwasher-safe.

### Set 4 pajitas + cepillo

Set de pailles + brosse  
4er-Set Strohhalm mit Reinigungsbürste  
Set of 4 straws + cleaning brush  
Conjunto de 4 palhinhas + escova

	Ref	€	Color	Ø (mm)	h (cm)	U.Venta
<b>A</b>	63131	4,90	Inox	6	21,5	1
<b>B</b>	69338	4,60	Inox	6	25,5	1
<b>C</b>	63132	7,30	Copper	6	21,5	1
<b>D</b>	63133	3,00	Cristal · Glass	6	21,5	12





# Batidora Profesionales **BLACK & WHITE**



· Professional use ·



- **Potencia y resultados profesionales.**
- **Disfruta del placer de cocinar con la batidora profesional.**
- **Gracias a su gran rendimiento, potente motor, calidad y durabilidad lograrás resultados extraordinarios.**
- **La batidora ofrece una gran versatilidad y es ideal para elaborar todo tipo de zumos, batidos, sopas, salsas, patés, granizados, helados etc.**
- **Incluye un completo recetario con todo tipo de recetas diseñado por Lauri Bengochea ([www.mitallerdebienestar.com](http://www.mitallerdebienestar.com)) en exclusiva para Lacor.**

- Performance et résultats professionnels.
- Cuisinez avec plaisir grâce au Blender Professionnel.
- Sa performance, son puissant moteur, sa qualité et durée de vie vous donneront des résultats extraordinaires.
- Le blender offre une grande flexibilité et est idéal pour élaborer tout type de jus, smoothies, soupes, sauces, pâtés, granizado (boissons rafraîchissantes), glaces, etc.
- Il contient un livre de recettes élaboré par Lauri Bengochea ([www.mitallerdebienestar.com](http://www.mitallerdebienestar.com)) en exclusivité pour Lacor.

- Meisterliche Leistung und Ergebnisse.
- Mit diesem Profi-Mixer macht Kochen Spaß.
- Dank seiner Ergiebigkeit, Power, Qualität und Langlebigkeit gelingt alles bestens.
- Der Mixer ist sehr vielseitig und eignet sich perfekt zum Bereiten von Säften, Shakes, Suppen, Saucen, Pasteten, Slush, Eis usw.
- Samt Rezepthef von Lauri Bengochea mit vielen leckeren Rezeptideen ([www.mitallerdebienestar.com](http://www.mitallerdebienestar.com)) - speziell für Lacor.

- Power and Professional Results.
- Enjoy the pleasure of cooking with the Professional Mixer.
- Thanks to its high performance, powerful motor, quality and durability you'll get extraordinary results.
- The mixer is extremely versatile and perfect for making all kinds of juices, shakes, soups, sauces, pâtés, iced drinks, ice cream and more.
- It comes with a complete cookbook with all kinds of recipes designed exclusively for Lacor by Laura Bengochea ([www.mitallerdebienestar.com](http://www.mitallerdebienestar.com)).

- Potência e resultados profissionais.
- Desfruta do prazer de cozinhar com a Batedeira Profissional.
- De grande qualidade e durabilidade, o seu grande rendimento e o seu potente motor permitir-te-ão alcançar resultados extraordinários.
- De grande versatilidade, a batedeira é ideal para elaborar todo o tipo de sumos, batidos, sopas, molhos, patés, granizados, gelados, etc.
- Inclui um completo livro com todo o tipo de receitas, da autoria de Lauri Bengochea ([www.mitallerdebienestar.com](http://www.mitallerdebienestar.com)) criado em exclusivo para Lacor.



**Batir, picar y moler**  
Battre, hacher et mouler  
Blend, chop and grind



## Batidora profesional BLACK

Batteur professionnel  
Profi-Mixer  
Professional blender  
Batedor profissional

Ref	€	W	L	U.Venta
69195	485,60	1200	2,0	1



## Batidora profesional WHITE

Batteur professionnel  
Profi-Mixer  
Professional blender  
Batedor profissional

Ref	€	W	L	U.Venta
69295	420,10	1200	1,5	1

Ref	Tensión/Voltage	Potencia/Power	Velocidad/Speed	Capacidad/Capacity	Dimensiones/Sizes	Peso/Weight
69195	220-240 V; 50/60 Hz	1200 W	13.300 - 38.000 r.p.m	2,0 L	28x26x52 cm	5,00 Kg
69295	220-240 V; 50/60 Hz	1200 W	13.000 - 38.000 r.p.m	1,5 L	18x24x42 cm	4,00 Kg

## Accesorios

Accessoires · Zubehör · Accessories · Acessórios

**Apta para las batidoras 69195 y 69295.**  
Apte pour les mixeurs 69195 et 69295.  
Geeignet für die Mixer 69195 und 19295.  
Apt for blenders 69195 and 69295.  
Apta para as bateadeiras 69195 e 69295.



### Jarra batidora con cuchillas

Pot batteur avec lamestl  
Krug mit Messer für Mixer  
Blender jug with blades  
Jarra batidora com lâminas

Ref	€	L	U.Venta
R69195N	190,50	2,0	1 Jarra · Jug
R69195B	48,00	2,0	1 Tapa · Lid



**Apta para las batidoras 69195 y 69295.**  
Apte pour les mixeurs 69195 et 69295.  
Geeignet für die Mixer 69195 und 19295.  
Apt for blenders 69195 and 69295.  
Apta para as bateadeiras 69195 e 69295.



### Jarra batidora con cuchillas

Pot batteur avec lamestl  
Krug mit Messer für Mixer  
Blender jug with blades  
Jarra batidora com lâminas

Ref	€	L	U.Venta
R69295A	188,00	1,5	1 Jarra + Tapa · Jug + Lid
R69295D	74,70	-	1 Tapa · Lid



**Aísla y reduce el nivel de ruido un 80%. Apta para las batidoras 69195 y 69295.**  
Isolé et réduit le niveau de bruit de 80%. Apte pour les mixeurs 69195 et 69295.  
Isoliert und reduziert den Geräuschpegel um 80%. Geeignet für die Mixer 69195 und 19295.  
Isolates and reduces the noise level by 80%. Apt for blenders 69195 and 69295.  
Isola e reduz em 80% o nível de ruído. Apta para as bateadeiras 69195 e 69295.

#### NOTA

La carcasa solo es valida si las batidoras llevan la jarra baja (R69295A), NUNCA con la jarra alta (R69195N).

#### REMARQUE

La carcasse n'est valable que si les mixeurs possèdent un bol bas (R69295A), JAMAIS avec un bol haut (R69195N).

#### ANMERKUNG

Das Gehäuse kann nur verwendet werden, wenn die Mixer mit einem niedrigen Krug ausgestattet sind (R69295A), KEINESFALLS mit dem hohen Krug verwenden (R69195N).

#### NOTE

The casing is only valid if the blender comes with a lower recipient (R69295A), NEVER for a higher recipient (R69195N).

#### NOTA

A carcaça só é utilizável se as bateadeiras utilizam o jarro baixo (R69295A). NUNCA utilizar se a bateadeira utiliza o jarro alto (R69195N).

### PC

Polycarbon

### Carcasa aislante de ruido

Boîtier isolant du bruit  
Geräuschdämpfendes Gehäuse  
Noise reducing enclosure  
Carcaça isolante do ruído

Ref	€	cm	h (cm)	U.Venta
R69295B	244,10	25x30	46	1

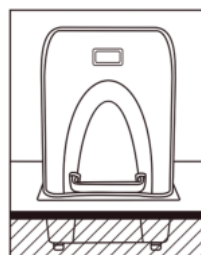

#### Posibilidad de encastrar.

**Dimensiones del agujero: 25,5 x 26,5 cm.**

Possibilité d'encastrar.

Dimensions du trou : 25,5 x 26,5 cm.

Möglichkeit von encastrate.

Abmessungen des Lochs: 25,5 x 26,5 cm.

Encastrable option.

Dimensions of the hole: 25,5 x 26,5 cm.

Possibilidade de encastrar.

Dimensões do furo: 25,5 x 26,5 cm.



# Batidoras INOX · WHITE · VITA



· Household use ·



## 69581 - Batidora INOX

- Ideal para elaborar todo tipo de zumos, batidos, cremas, salsas, granizados, etc.
- Potente motor de 1000 W para licuar, mezclar y triturar de manera rápida y eficaz.
- Control de velocidad variable con display luminoso, seleccione la velocidad deseada con la ruleta.
- Tres funciones pre-establecidas: Pulse · Ice crush · Smoothie.  
Velocidad PULSE para batir al gusto a máxima velocidad.  
Velocidad ICE CRUSH, función especial para picar hielo.
- Jarra de vidrio borosilicato con escala (ml / cups / oz) de alta calidad resistente a los arañazos de 1,50 L.
- Vaso medidor de 50 ml / 1-3 / 4 oz.
- 6 cuchillas lisas desmontables de acero inoxidable de alta calidad.
- Cuerpo en acero inoxidable. Pies antideslizantes, aportan estabilidad a la hora del uso.

- Idéal pour préparer tout type de jus, milk-shakes, crèmes, sauces, granités, etc.
- Puissant moteur de 1000 W pour mixer, mélanger et triturer de façon rapide et efficace.
- Contrôle de vitesse variable avec affichage lumineux, sélection de la vitesse souhaitée avec le bouton rotatif.
- Trois fonctions préétablies : Pulse · Ice crush · Smoothie.  
Vitesse PULSE pour mixer à sa guise à la vitesse maximum.  
Vitesse ICE CRUSH, fonction spéciale pour piler la glace.
- Bol en verre borosilicate avec graduations (ml / cups / oz) de grande qualité résistant aux rayures de 1,50 L.
- Verre doseur de 50 ml / 1-3 / 4 oz.
- 6 lames lisses démontables en acier inoxydable de grande qualité.
- Corps en acier inoxydable. Pieds antidérapants, qui apportent une stabilité lors de l'utilisation.

- Ideal for making all types of juices, smoothies, creams, sauces, slushies, etc.
- Powerful 1000 W motor to liquefy, mix, and chop quickly and efficiently.
- Variable speed control with illuminated display, select the desired speed using the selector knob.
- Three pre-set functions, Pulse · Ice Crush · Smoothie.  
PULSE speed to blend foods to desired texture at maximum speed.  
ICE CRUSH speed, special function for crushing ice.
- High-quality scratch-resistant borosilicate glass pitcher (ml / cups / oz) 1.5 L.
- Measuring cup 50 ml / 1-3/4 oz.
- 6 detachable high quality stainless steel flat blades.
- Stainless steel body. Anti-slip base, provides stability in operation.

**Doble rodamiento · Double ball bearing**  
**Alarga la vida útil de las cuchillas**  
Extend the lifespan of the blades



**Eje central conjunto**  
Central assembly axis

**Eje central cuchillas**  
Central blades axis

**Sistema Patentado**



**Eje central de las cuchillas descentrada respecto al eje central del conjunto.**  
**Creará vórtices irregulares, evita obstrucciones y genera cortes más profundos.**  
Central blade axis offset from the central assembly axis.  
Creates uneven vortices, avoid blockages and make deeper cuts.

## 69587 - Batidora WHITE

- Ideal para elaborar todo tipo de zumos, batidos, cremas, salsas, granizados, etc.
- Potente motor de 700 W para licuar, mezclar y triturar de manera rápida y eficaz.
- 2 velocidades + Pulse. Seleccione la velocidad deseada con la ruleta.
- Velocidad PULSE para batir al gusto a máxima velocidad.
- Jarra de cristal con escala (ml / cups / oz) de alta calidad resistente a los arañazos de 1,50 L con cierre de seguridad.
- Vaso medidor de 50 ml / 1-3/4 oz.
- 4 cuchillas lisas desmontables de acero inoxidable de alta calidad.
- Pies antideslizantes, aportan estabilidad a la hora del uso.

- Idéal pour élaborer tous types de jus, smoothies, soupes, sauces, crèmes, granités, etc.
- Puissant moteur de 700 W pour mixer, mélanger et triturer de façon rapide et efficace.
- 2 vitesses + Pulse, sélection de la vitesse souhaitée avec le bouton rotatif.
- Vitesse PULSE pour mixer à la vitesse maximum.
- Bol en verre avec graduation (ml / cups / oz) de grande qualité résistant aux rayures de 1,50 L avec fermeture de sécurité.
- Verre mesureur de 50 ml / 1-3/4 oz.
- 4 lames lisses démontables en acier inoxydable de grande qualité.
- Pieds antidérapants, qui apportent une stabilité lors de l'utilisation.

- Perfect for making all kinds of juices, shakes, soups, sauces, patés, smoothies, etc.
- Powerful 700 W motor for blending, mixing and grinding quickly and effectively.
- 2 speeds + Pulse, select the speed you want with the dial.
- PULSE speed for beating food as you like at maximum speed.
- High quality 1.5 L scratch resistant glass pitcher with measurements (ml/cups/oz) with safety latch.
- 50 ml / 1 3/4 oz measuring cup.
- 4 high quality stainless steel removable smooth blades.
- Non-slip feet provide stability during use.



### Batidora INOX

Mélangeur  
Mixer  
Blender  
Batedor

Ref	€	W	L	U.Venta
69581	156,40	1000	1,50	1



### Batidora WHITE

Mélangeur  
Mixer  
Blender  
Batedor

Ref	€	W	L	U.Venta
69587	80,00	700	1,50	1

Ref	Tensión/Voltage	Potencia/Power	Velocidad/Speed	Cap./Capacity	Medidor/ Measurer	Cuchillas/Blades	Dimensiones/Sizes	Peso/Weight
69581	220-240 V; 50 Hz	1000 W	11.000 - 16.500 r.p.m.	1,50L (6 cups/48oz)	50 ml	6	20,5x20x41,5 cm	4,00 Kg
69587	220-240 V; 50 Hz	700 W	14.392 - 16.000 r.p.m.	1,50L (6 cups/48oz)	50 ml	6	22x18x40 cm	3,40 Kg



### Batidor VITA

Mixer  
Mixer  
Blender  
Batedora

Ref	€	W	L	U.Venta
69081	85,40	500	1,5	1

Ref	Tensión/Voltage	Potencia/Power	Velocidad./Spdd	Capacidad/Capacity	Dimensiones/Sizes	Peso/Weight
69081	220-240 V; 50/60 Hz	500 W	10.000 - 12.000 r.p.m.	1,50 L	21x23x40 cm	3,24 Kg

- Función PULSE para batir a su gusto. Mantenga el mando en la posición P para mantener la batidora en marcha.
- Posición 1 para batir a baja revolución, en especial cuando pique hielo o elementos sólidos duros.
- Posición 2 le permite batir a máxima velocidad todo tipo de frutas blandas y líquidos.
- Asegúrese que la batidora esté en la posición 0 antes de extraer y verter el contenido de la jarra.

- Option PULSE pour battre à volonté, maintenez la commande sur la position P pour laissez le batteur en marche.
- Position 1 pour battre à faible révolution, notamment quand vous hachez des glaçons ou des éléments solides durs.
- Position 2 vous permet de battre à vitesse maximale tout type de fruits mous et liquides.
- Assurez-vous que le batteur se trouve en position 0 avant d'extraire et de verser le contenu de la jarra.

- Use the P option to blend as you choose; keep the switch on the P position to keep the blender working.
- 1 position to blend at low speed especially when crushing ice or hard solid items.
- 2 position allows you to blend all types of soft fruits and liquids at maximum speed.
- Ensure the blender is at the 0 position before removing and pouring the contents from the jug.

# Colección MÁQUINAS DE VACÍO



## ¿Qué es la cocción al vacío?

### Beneficios de la cocción a baja temperatura:

Entre las nuevas técnicas de restauración, la más importante es la cocción y conservación al vacío. Las ventajas que ofrece esta técnica aseguran su introducción y adaptación a las necesidades de cada cocina: ganar tiempo, mejora de costes, mejor organización del personal y mayor duración de los productos, manteniendo sus cualidades higiénicas y organolépticas, son algunas de las principales razones que auguran su éxito e introducción en la restauración.

Hablamos de productos sometidos a un proceso de envasado al vacío y expuestos a temperaturas que nunca superan los 100°C. Debido a la diferencia de presión, conseguimos temperaturas de ebullición del agua a baja temperatura y la penetración de temperatura a corazón de producto es lineal, es decir, no encuentra moléculas de aire y no produce una reacción radial, por lo que el tratamiento y los resultados obtenidos con el producto están perfectamente controlados.

La forma más sencilla de explicar la cocción al vacío es decir que en vez de guisar, como es tradicional, los alimentos a 130°C de calor por un periodo relativamente corto, aquí se cuecen entre 65°C y 99°C en tiempos más prolongados según la naturaleza del género y su peso. Es, pues, una cocción larga y a baja temperatura. En un horno convencional, una pieza de carne se cuece a 200°C de temperatura, lo que ocasiona que el exterior se tueste. Sin embargo, la temperatura en el corazón de la pieza rara vez supera los 50°C. Por lo tanto, sólo es necesaria una temperatura igual o ligeramente superior a los 65°C para cocer un alimento, evitando el resecamiento y el endurecimiento de la fibra muscular así como la sobrecocción.

## Qu'est-ce que la cuisson sous-vide ?

### Avantages de la cuisson à basse température :

Parmi les nouvelles techniques de restauration, la plus importante est la cuisson et la conservation sous-vide. Les avantages qu'offre cette technique garantissent son introduction et son adaptation aux besoins de chaque cuisine : gagner du temps, améliorer les coûts, une meilleure organisation du personnel et une plus grande durée de conservation des produits, en maintenant leur qualités hygiéniques et organoleptiques, sont quelques-unes des raisons principales qui expliquent son succès et son introduction dans la restauration.

Nous parlons de produits soumis à un processus de conditionnement sous-vide et exposés à des températures toujours inférieures à 100°C. En raison de la différence de pression, on obtient des températures d'ébullition de l'eau à basse température et la pénétration de la température au cœur du produit est linéaire, c'est-à-dire qu'elle ne rencontre pas de molécules d'air et ne produit aucune réaction radiale, c'est pourquoi le traitement et les résultats obtenus avec le produit sont parfaitement contrôlés.

La façon la plus simple d'expliquer la cuisson sous-vide est de dire qu'au lieu de cuisiner, comme c'est le cas traditionnellement, les aliments à une température de 130°C pendant un laps de temps relativement court, ils sont ici cuits entre 65°C et 99°C pendant un laps de temps plus long selon la nature du genre et le poids. Il s'agit donc d'une cuisson longue et à basse température. Dans un four conventionnel, une pièce de viande est cuite à une température de 200°C, ce qui provoque le brunissage de l'extérieur. Cependant, la température au cœur de la pièce dépasse rarement 50°C. Par conséquent, il suffit d'une température égale ou légèrement supérieure à 65°C pour cuire un aliment, évitant ainsi le dessèchement et le durcissement de la fibre musculaire ainsi que la surcuisson.

## What is Sous Vide?

### The benefits of low-temperature cooking

Among the new techniques for cooking professionals, the most important one is cooking and storing food in vacuum sealed pouches. The advantages of the technique mean it will be used in and adapted to the needs of every kitchen. Some of the main reasons why it will be successful and widely used in the hospitality industry are the savings in time and money, better staff organisation and being able to store products longer without sacrificing organoleptic qualities or hygiene.

Sous vide refers to products that are vacuum sealed and never exposed to temperatures above 100° C. Because of the difference in pressure, water boils at a low temperature and heat penetrates into the heart of the product in a linear fashion which means there is no interference from air molecules and a radial reaction does not occur so consequently product manipulation and results can be perfectly controlled.

The simplest way to explain sous vide is to say that instead of the traditional method of cooking food at 130°C for a relatively short time food is cooked at 65°C to 99°C for a longer time, depending on the type of product and how much it weighs. It's essentially slow cooking at a low temperature. In a conventional oven, a piece of meat is cooked at 200°C, which makes the outside brown and crispy. However, the temperature in the centre rarely exceeds 50°C. So you can see that meat only needs to be cooked at 65°C or a little hotter, which prevents it from drying out or getting tough as well as over cooking.

## Tabla orientativa · Tableau d'orientation · Guidance table

Almacén Storehouse	25°C +/- 2°C									
<b>Almacenamiento normal</b> Normal storage life					1-2 semanas 1-2 weeks	3-4 días 3-4 days	2-4 días 2-4 days	1 semana 1 week	5-6 meses 5-6 months	
<b>Sellado al vacío</b> Vacuum sealed life					2-4 semanas 2-4 weeks	2 semanas 2 weeks	2 semanas 2 weeks	2-4 semanas 2-4 weeks	1 año 1 year	
<b>Frigorífico</b> Fridge	5°C +/- 2°C									
<b>Almacenamiento normal</b> Normal storage life		1-2 semanas 1-2 weeks	1 semana 1 week	1 semana 1 week	3-4 días 3-4 days	2-4 semanas 2-4 weeks	1-2 semanas 1-2 weeks	1-2 semanas 1-2 weeks	1-2 semanas 1-2 weeks	2-3 días 2-3 days
<b>Sellado al vacío</b> Vacuum sealed life		1 mes 1 month	2-4 semanas 2-4 weeks	2-4 semanas 2-4 weeks	2 semanas 2 weeks	1 mes 1 month	1 mes 1 month	6-12 semanas 6-12 weeks	6-12 semanas 6-12 weeks	1 semana 1 week
<b>Congelador</b> Freezer	-18°C +/- 2°C									
<b>Almacenamiento normal</b> Normal storage life		6 meses 6 months	6 meses 6 months	6 meses 6 months	1-2 semanas 1-2 weeks	8 meses 8 months	8 meses 8 months	6-12 semanas 6-12 weeks	4 meses 4 months	
<b>Sellado al vacío</b> Vacuum sealed life		2-3 años 2-3 years	2-3 años 2-3 years	2-3 años 2-3 years	2 años 2 years	2-3 años 2-3 years	2-3 años 2-3 years	6 meses 6 months	1 año 1 year	

· Professional use ·



Altura interior útil 11 cm  
11 cm useful interior height



Inox

## Máquina de vacío campana

Machine sous vide à cloche  
Vakuuiergeräte  
Bell-shaped vacuum machine  
Máquina de vacío tipo câmara

Ref	€	W	U.Venta
69116	1.709,70	630	1

Ref	Tensión/Voltage	Potencia/Power	Vacío/Vacuum	Caudal bomba/Pump flow	L. sellado/Seal length	A. sellado/Seal width	Dimensiones/Sizes	Peso/Weight
69116	220-240 V; 50 Hz	630 W	0,9 bar	83 L/min	29 cm	4 cm	42x36x36,5 cm 35x30x5 cm (cámara - chamber)	24,5 Kg

- Admite la aspiración de líquidos y salsas, sin necesidad de congelarlos antes.
- Envasado por mediación de un COMPRESOR DE AIRE.
- Compresor con pistón, dispone de válvula de entrada y salida de aire.
- Al no ser de aceite no suele precisar mantenimiento alguno.

- Permet l'aspiration de liquides et de sauces, sans avoir à les congeler auparavant.
- Mise sous vide au moyen d'un COMPRESSEUR D'AIR.
- Compresseur avec piston, dispose de valve d'entrée et de sortie d'air.
- Dans la mesure où il n'y a pas d'huile, aucun entretien n'est nécessaire.
- Ermöglicht das Absaugen von Flüssigkeiten und Soßen im Beutel, ohne dass diese vorher eingefroren werden müssen.
- Abfüllung mit Hilfe eines DRUCKLUFTKOMPRESSORS.
- Kolbenkompressor mit Druckluftein- und -ausgangsventil.
- Da kein ÖL komprimiert wird, ist normalerweise keine Wartung erforderlich.
- Enables liquids and sauces to be aspirated in the bag with no need to freeze them first.
- U.Ventaaging using an AIR COMPRESSOR.
- Compressor with piston, has an air inlet/outlet valve.
- As it is not oil-based, no maintenance is required.

- Admite a aspiração de líquidos e de molhos, sem necessidade de os congelar previamente.
- Embalagem por meio de um COMPRESSOR DE AR.
- O compressor de pistão dispõe de válvula de entrada e saída de ar.
- Ao não utilizar óleo, não querer qualquer tipo de manutenção.

· Professional use ·



Inox

## Máquina de vacío campana

Machine sous vide à cloche  
Vakuuiergeräte  
Bell-shaped vacuum machine  
Máquina de vacío tipo câmara

Ref	€	W	U.Venta
69352	972,30	350	1

Ref	Tensión/Voltage	Potencia/Power	Vacío/Vacuum	Caudal bomba/Pump flow	L. sellado/Seal length	A. sellado/Seal width	Dimensiones/Sizes	Peso/Weight
69352	220-240 V; 50/60 Hz	350 W	0,9 bar	60 L/min	30 cm	2,5 cm	42x38x27 cm 30,5x32,2x8 cm (cámara - chamber)	10 Kg

- Realización de bolsas.
- Admite la aspiración de líquidos y salsas, sin necesidad de congelarlos antes.

- Réalisation de sachets.
- Permet l'aspiration de liquides et de sauces, sans avoir à les congeler auparavant
- Erstellung von Beutel.
- Ermöglicht das Ansaugen von Flüssigkeiten und Soßen ohne vorheriges Gefrieren in die VerU.Ventaung.
- Making bags.
- Enables liquids and sauces to be aspirated in the bag with no need to freeze them first.
- Confeccionar sacos.
- Admite a aspiração de líquidos e de molhos, sem necessidade de os congelar previamente.



**Bobina incluida**  
Coil tube included

## Accesorio

Accessoire · Zubehör · Accessorie · Acessório



### Pestañas para colocar en la máquina de vacío PROFESIONAL

Eyelashes to place in the PROFESSIONAL vacuum machine

### Cuchilla interna deslizante, proporciona un corte limpio y preciso

The internal sliding blade makes a clean and precise cut



### Soporte para rollo

Porte-rouleau  
Rollenhalter  
Roll holder  
Suporte de rolo

### Compatible para bobinas hasta:

Compatible for coils up to:  
**69531 - 30 cm**  
**69541 - 40 cm**

Ref	€	L (cm)	U.Venta	
69531	24,50	30	1	Compatible con la ref.: 69530
69541	29,80	40	1	Compatible con la ref.: 69540

- Máquina de envasado al vacío profesional, prestaciones de primer nivel.
- Ideal para preparar Sous vide, marinar platos, almacenar distintos alimentos naturales o cocinados, etc.
- Un buen sellado hermético garantiza el sabor, el valor nutricional, la frescura y la protección de los alimentos, aumentando la vida útil entre 2 y 4 veces más.
- Funcionamiento intuitivo y sencillo.
- Doble bomba de vacío muy potente, garantiza un vacío óptimo.
- Ciclo de envasado totalmente automático.
- Función de sellado continuo.
- Función marinado, muy útil para ahorrar tiempo frente a los marinados convencionales.
- Equipada con una barra de sellado extra ancha de 5 mm.
- Carcasa externa de acero inoxidable, robusta e higiénica.
- Gracias a su asa en la tapa el envasado al vacío será más cómodo.
- Bandeja extraíble para pequeñas cantidades de líquidos.
- Incluye 2 pestañas en su parte posterior para adaptar el soporte para rollo (NO incluido).
- Se apoya en cuatro pies de goma para una mayor estabilidad.

- Machine professionnelle d'emballage sous vide, performances de premier ordre.
- Idéale pour préparer Sous vide, faire mariner des plats, stocker différents aliments naturels ou cuisinés, etc.
- Un bon scellage hermétique garantit le goût, la valeur nutritionnelle, la fraîcheur et la protection des aliments, 2 à 4 fois plus de durée de conservation.
- Fonctionnement simple et intuitif.
- Pompe à vide double très puissante, assure un vide optimal.
- Cycle d'emballage entièrement automatique.
- Fonction de scellage continue.
- Fonction marinade, très utile pour gagner du temps par rapport aux marinades conventionnelles.
- Équipée d'une barre de scellage extra large de 5 mm.
- Carcasse externe robuste et hygiénique en acier inoxydable.
- Grâce à sa poignée sur le couvercle, l'emballage sous vide sera plus pratique.
- Plateau pour petites quantités de liquides amovibles.
- Comprend 2 languettes à l'arrière pour adapter le porte-rouleau (NON inclus).
- Quatre pieds en caoutchouc pour une plus grande stabilité.

- Professional vacuum U.Ventaaging machine, top quality features.
- Ideal to prepare Sous vide, marinate dishes, and store different raw or cooked foods, etc.
- A proper airtight seal guarantees the flavour, nutritional value, freshness, and protection of food extending its useful life between 2 and 4 times.
- Intuitive and simple operation.
- Very powerful dual vacuum pump, guarantees optimal vacuum.
- Fully automatic U.Ventaaging cycle.
- Continuous sealing function.
- Marinate function, very useful to save time compared to conventional marinating.
- Equipped with an extra-wide 5mm sealing bar.
- Sturdy and hygienic stainless steel outer housing.
- The lid handle provides improved comfort for vacuum U.Ventaaging.
- Tray for small amounts of extractable liquids.
- Includes 2 tabs on the back to adapt the support for the roll (NOT included).
- Includes four rubber support bases for greater stability.

A



Inox

### Máquina de vacío PROFESIONAL

Machine sous vide  
Vakuumiergerät  
Vacuum pack machine  
Máquina de vacío

	Ref	€	W	L (cm)	U.Venta
A	69530	537,50	700	30	1
B	69540	597,30	650	40	1



### Función canister

Canister function



B



Grado de protección IP20  
IP20 degree of protection

Ref	Tensión/Voltage	Potencia/Power	Presión/Pressure	Caudal bomba/Pump flow	L. sellado/Seal length	A. sellado/Seal width	Dimensiones/Sizes	Peso/Weight
69530	220-240 V; 50-60 Hz	700 W	0,9 bar	16 L/min (2 pumps)	31 cm	5 mm	39x27,5x13 cm	6,90 Kg
69540	220-240 V; 50-60 Hz	650 W	0,9 bar	16 L/min (2 pumps)	40 cm	5 mm	49x26x12,5 cm	8,50 Kg

· Semiprofessional use ·

**Doble bomba de vacío muy potente**  
Very powerful dual vacuum pump

**Función MARINATE y PULSE**  
MARINATE and PULSE functions

**3 niveles de tiempo de sellado (secos, húmedos...)**  
Three levels of sealing time (dry, wet, etc.)

**Inox**

## Máquina de vacío EFFICIENT

Machine sous vide  
Vakuumiergerät  
Vacuum pack machine  
Máquina de vacío

**Bobinade 28 cm x 5 m (incluida)**  
28 cm x 5 m coil tube (included)

**Doble banda de sellado**  
Wide double-band

**Barra para corte instantáneo**  
Bar for instant cutting

**Orificio para la aspiración de los botes**  
Opening for the sealing of canisters

Ref	€	W	U.Venta
69353	226,20	130	1

Ref	Tensión/Voltage	Potencia/Power	Presión/Pressure	Caudal bomba/Pump flow	L. sellado/Seal length	A. sellado/Seal width	Dimensiones/Sizes	Peso/Weight
69353	220-240 V; 50 Hz	130 W	0,9 bar	20 L/min (2 pump)	30 cm	2 mm (2)	40x19,4x11 cm	2,90 Kg



**Posibilidad de realización de bolsas**  
**Bobina incluida - 22 cm x 3 m**  
Possibility of making bags  
Coil tube included - 22 cm x 3 m

**Orificio para la aspiración de los botes**  
Opening for the sealing of canisters

## Máquina de vacío MAXI

Machine sous vide  
Vakuumiergerät  
Vacuum pack machine  
Máquina de vacío

Ref	€	W	U.Venta
69350	150,80	120	1

Ref	Tensión/Voltage	Potencia/Power	Presión/Pressure	Caudal bomba/Pump flow	L. sellado/Seal length	A. sellado/Seal width	Dimensiones/Sizes	Peso/Weight
69350	220-240 V; 50/60 Hz	120 W	0,6 - 0,8 bar	12 l/min	30 cm	3 mm	43,5x21x10 cm	2,05 Kg

**Incluye 10 bolsas de vacío (20x30 cm)**  
Includes 10 vacuum bags (20x30 cm)

**Incluye 10 bolsas de vacío: 20x30 cm (5) / 28x40 cm (5)**  
Includes 10 vacuum bags: 20x30 cm (5) / 28x40 cm (5)



**Con orificio para la aspiración de los botes**  
With opening for the sealing of canisters

## Máquina de vacío HOME

Machine sous vide  
Vakuumiergerät  
Vacuum pack machine  
Máquina de vacío

Ref	€	W	U.Venta
69050	108,40	110	1

## Máquina de vacío LUXE

Machine sous vide  
Vakuumiergerät  
Vacuum pack machine  
Máquina de vacío

Ref	€	W	U.Venta
69151	122,90	120	1

Ref	Tensión/Voltage	Potencia/Power	Presión/Pressure	Caudal bomba/Pump flow	L. sellado/Seal width	Dimensiones/Sizes	Peso/Weight
69050	220-240 V; 50 Hz	110 W	0,8 bar	9 l/min	28 cm (max)	35,7x14,8x8,7 cm	1,40 Kg
69151	220-240 V; 50 Hz	120 W	0,4 - 0,8 bar	9 l/min	30 cm (max)	37x14,4x7,4 cm	1,55 Kg



## Ultrarrápido / Ultra-fast:



**Reduce 6 pasos en 3** · Réduit 6 étapes en 3  
 Reduziert sechs auf drei Arbeitsschritte · Turns 6 steps into 3  
 Apenas 3 passos em lugar dos habituais 6



**AutoPlace**  
**Garantiza la colocación correcta de la bolsa**  
 Placement correct des sacs garanti  
 Beutel wird garantiert immer richtig eingezogen  
 Ensures bags are inserted correctly  
 Assegura a colocação correta do saco



**Tapa totalmente extraíble**  
 Totally removable lid



**Accesorio para función canister**  
 Accessory for canister function

### Máquina de vacío SMART

Machine sous vide  
 Vakuuiergerät  
 Vacuum pack machine  
 Máquina de vacío

Ref	€	W	U.Venta
69357	104,00	120	1



**Fácil limpieza**  
 Easy cleaning



**Accesorio para función canister**  
 Accessory for canister function

### Máquina de vacío AUTOPRO

Machine sous vide  
 Vakuuiergerät  
 Vacuum pack machine  
 Máquina de vacío

Ref	€	W	U.Venta
69356	96,60	120	1

- Doble bomba de vacío con poder de succión de 5 L/min (69357).
- Doble bomba de vacío con poder de succión de 4,3 L/min (69356).
- Ultra rápido: reduce 6 pasos en 3.
- Potente bomba de vacío de hasta 80kpa que garantiza un nivel de vacío óptimo.
- Sellado 100% automático, tan solo pulsando un botón.
- AutoPlace: garantiza la colocación correcta de la bolsa.
- Garantiza la calidad, frescor y sabor de los alimentos durante mucho más tiempo.
- Diseñada para alimentos crudos y cocinados; pescado, carne, verdura, legumbre, embutido, fruta, frutos secos y cocina a baja temperatura.
- Barra de sellado de bolsa de 30 cm de largo.
- Sellado múltiple: sella varias bolsas simultáneamente.
- Contiene un orificio para la aspiración de los botes.
- Diseño compacto y ligero. Funcionamiento intuitivo y sencillo.
- Tapa extraíble para facilitar la limpieza.
- Incluye: 10 bolsas de vacío (20x30 cm) libres de BPA.

- Double pompe à vide avec une puissance d'aspiration de 5 L/min (69357).
- Double pompe à vide avec une puissance d'aspiration de 4,3 L/min (69356).
- Ultra rapide : réduit 6 étapes en 3.
- Pompe à vide puissante pouvant atteindre 80kpa garantissant un niveau de vide optimal.
- Scellage 100% automatique par simple pression sur un bouton.
- AutoPlace : placement correct des sacs garanti.
- Qualité, fraîcheur et saveur garanties des aliments pendant beaucoup plus longtemps.
- Conçue pour les aliments crus et cuits ; poisson, viande, légumes, légumineuses, saucisses, fruits, fruits secs et cuisson à basse température.
- Barre de scellement de sacs de 30 cm de long.
- Scellage multiple : scelle plusieurs sacs simultanément.
- Contient un trou pour l'aspiration des bocaux.
- Conception compacte et légère. Fonctionnement intuitif et simple.
- Comprend : 10 sacs sous vide (20x30 cm) sans BPA.

- Double vacuum pump with 5 L/min suction power (69357).
- Double vacuum pump with 4,3 L/min suction power (69356).
- Ultra-fast: turns 6 steps into 3.
- Powerful vacuum pump with up to 80 kpa ensures an optimal vacuum.
- 100% automatic sealing with the push of a button.
- AutoPlace: ensures bags are inserted correctly.
- Guarantees the quality, freshness and flavour of food for a lot longer.
- Designed for cooked or raw food: fish, meat, vegetables, legumes, cold cuts, fruit, nuts and low temperature cooking.
- 30 cm long bag sealing bar.
- Multiple sealing: can seal several bags simultaneously.
- It has a hole for doing vacuum in containers.
- Compact and lightweight design Simple and intuitive use.
- Includes: 10 BPA free vacuum bags (20x30 cm).

Ref	Tensión/Voltage	Potencia/Power	Presión/Pressure	C. bomba/P. flow	L sellado/Seal width	A. sellado/Seal w.	Dimensiones/Sizes	Peso/Weight
69357	220-240 V; 50 Hz	120 W	0,8 bar	5,0 L/min	30 cm	2,7 mm	37,8x16,1x5,9 cm	1,62 Kg
69356	220-240 V; 50 Hz	120 W	0,8 bar	4,3 L/min	30 cm	2,7 mm	37,8x17x5,8 cm	1,45 Kg



**Compartimento para líquidos**  
Compartment for liquids



**Orificio para la aspiración de los botes**  
Opening for the sealing of canisters



- Sella herméticamente los alimentos aumentando de 3 a 5 veces más su durabilidad.
- Expulsa el aire y la humedad, manteniendo sus sabores y nutrientes.
- Panel de control táctil, 2 niveles de envasado al vacío: alimentos húmedos y secos.
- Bandeja para recoger líquidos en la parte posterior de la máquina.
- Gracias a su diseño vertical ocupa poco espacio.

- Scellage hermétique des aliments, augmentant ainsi de 3 à 5 fois leur durabilité.
- Expulse l'air et l'humidité, en conservant leurs saveurs et leurs nutriments.
- Tableau de contrôle tactile, 2 niveaux de conditionnement sous vide : aliments humides et aliments secs.
- Plateau pour recueillir les liquides dans la partie arrière de la machine.
- Prend moins de place grâce à sa conception verticale.

- Versiegelt die Nahrungsmittel luftdicht und verlängert deren Haltbarkeit um das 3- bis 5-fache.
- Es werden Luft und Feuchtigkeit abgeleitet und der Geschmack sowie die Nährstoffe bewahrt.
- Sensorbedienfeld, 2 Vakuuierstufen: feuchte und trockene Nahrungsmittel.
- Auffangwanne für Flüssigkeiten auf der Rückseite des Geräts.
- Dank des vertikalen Designs platzsparend.

- Hermetically seals the food, increasing its shelf life by 3 to 5 times.
- Expels air and moisture, maintaining the food's flavours and nutrients.
- Touch control panel, 2 levels of vacuum packaging: moist and dry foods.
- Liquid collection tray on the back of the machine.
- Takes up little space thanks to its vertical design.

- Sela herméticamente os alimentos, aumentando de 3 a 5 vezes a sua validade.
- Expulsa o ar e a humidade, conservando os sabores e os nutrientes.
- Painel de controlo tátil, 2 níveis de embalagem em vácuo: alimentos húmidos e secos.
- Bandeja para recolher líquidos na parte posterior da máquina.
- O seu desenho vertical economiza espaço.

**Incluye:**

**5 bolsas de 20x30cm / Bobina de 20cmx2m / Tubo canister de 40 cm de largo**  
Includes: 5 20x30cm bags / 20cmx2m coil tube / 40 cm-long canister hose

**Máquina de vacío EXTREME**

Machine de conditionnement sous vide  
Vakuumiergerät  
Vacuum machine  
Máquina de vacío

Ref	€	W	U.Venta
69355	146,30	110	1

Ref	Tensión/Voltage	Potencia/Power	Presión/Pressure	Cap. bomba/Pump Cap.	L. Sellado/Seal	Dimensiones/Sizes	Peso/Weight
69355	220-240 V; 50 Hz	110 W	0,8 bar	12 L/min	30 cm (W=2,5 mm)	42x9,5x15 cm	1,70 Kg



**Tres funciones; sellado de bolsa, función automática y función manual**

Three functions; bag sealing, automatic function and manual function



**Orificio para la aspiración de los botes**  
Opening for the sealing of canisters

- Envasadora al vacío doméstica y compacta, perfecta para uso diario.
- Ideal para el almacenamiento de alimentos a largo plazo, aumentando la vida útil entre 2 y 4 veces más y conservando el sabor, el valor nutricional y la frescura. Perfecta para alimentos crudos y cocinados.
- Funcionamiento intuitivo y sencillo.
- Tres funciones disponibles:
  - \* Función de sellado de bolsa.
  - \* Función automática, perfecta para conservar alimentos secos y duros (semillas, granos de café, frutos secos, pasta, hortalizas duras, etc.).
  - \* Función manual, cuando queremos conservar alimentos frágiles como pescados, frutas, champiñones, pan, bizcochos, etc.
- Contiene un orificio para la aspiración de los botes.

- Scelleuse sous-vide domestique et compacte, parfaite pour une utilisation quotidienne.
- Idéal pour conserver des aliments à long terme, augmente de 2 à 4 fois leur vie utile tout en conservant leur goût, la valeur nutritionnelle et la fraîcheur. Parfaite pour des aliments crus et cuisinés.
- Fonctionnement intuitif et simple.
- Fonctions possibles :
  - \* Fonction de soudure de sachet.
  - \* Fonction automatique, parfait e pour conserver les aliments secs et durs (graines, grains de café, fruits secs, pâtes, légumes, etc...).
  - \* Fonction manuelle, pour garder des aliments plus fragiles comme le poisson, les fruits, des champignons, du pains, des biscuits etc.
- Avec orifice pour aspirer les pots.

**Inox**



**Máquina de vacío SLIM**

Machine sous vide  
Vakuumiergerät  
Vacuum Upackmaschine  
Máquina de vacío

Ref	€	W	U.Venta
69354	80,30	80	1

- Compact vacuum packing machine, perfect for daily home use.
- Ideal for long-term storage of food, making shelf-life to about 2 to 4 times more while preserving the flavour, nutritional value and freshness. Perfect for raw and cooked foods.
- Intuitive and simple operation.
- There are three functions available:
  - \* Bag sealing function.
  - \* Automatic, ideal function for preserving dry and hard foods (seeds, coffee beans, nuts, pasta, hard vegetables, etc.).
  - \* Manual function, for preserving fragile food like fish, fruits, mushrooms, bread, biscuits... etc.
- A hole for drawing out air from canisters.

Ref	Tensión/Voltage	Potencia/Power	Presión/Pressure	Caudal bomba/Pump flow	L. sellado/Seal length	A. sellado/Seal width	Dimensiones/Sizes	Peso/Weight
69354	220-240 V; 50 Hz	80 W	0,5 bar	4 L/min (1 pump)	30 cm	2 mm	38,4x9,7x5,7 cm	1,00 Kg

# Bobinas · Bolsas · Botes para **VACÍO**



- Apto para uso alimenticio.
- Recomendada para uso con máquina de vacío de la marca LACOR.
- No se recomienda su reutilización tras el uso con carnes, pescados y otros alimentos deteriorables, tan solo tras el uso en productos secos, legumbres, frutos secos, etc.

- Adaptée au conditionnement de denrées alimentaires.
- Recommandée pour être utilisée avec la machine à emballer sous vide LACOR.
- Son utilisation est déconseillée pour reconditionner de la viande, du poisson et d'autres denrées alimentaires périssables. Elle peut être réutilisée pour reconditionner des fruits secs, des légumes, des fruits secs, etc.

- Lebensmittelgeprüft.
- Empfohlen für den Einsatz mit Vakuumerät der Marke LACOR.
- Nicht empfohlen wird die Wiederverwendung nach Verwendung für Fleisch, Fisch und sonstigen verderblichen Lebensmitteln. Wiederverwendung nur nach Verwendung für trockene Produkte, Hülsenfrüchte, Trockenfrüchte etc.

- Suitable for use with food.
- Recommended for use with vacuum Packer of the LACOR brand.
- Not recommended to be reused after use with meats, fish and other fresh foods, only after use with dried products, pulses, nuts, etc.

- Adequado para uso de alimentos.
- Recomendado para usar com máquina de vácuo do marca LACOR.
- Não recomendado para reutilização após a utilização com carnes, peixes e outros alimentos perecíveis, somente após a utilização em produtos secos, legumes, nozes, etc.



## Bolsas vacío

Sacs de conservation sous vide  
Vakuumbutel, 100 Stueck  
Vacuum bags  
Sacos de vácuo

Ref	€	Bolsa	Unidades	Micras	U.Venta
69053	5,10	16x20	25	105	6
69054	8,70	20x30	25	105	6
69055	11,70	24x36	25	105	1
69056	14,70	28x40	25	105	1
69042	32,20	20x30	100	105	1
69046	47,00	25x35	100	105	1
69047	64,00	30x40	100	105	1
69048	128,50	40x60	100	105	1
69453	6,00	16x20	25	90	6
69454	11,00	20x30	25	90	1
69455	15,40	24x36	25	90	1
69460	5,60	20x30	25	105	1
69461	10,10	28x40	25	105	1

## Bobina tubo vacío

Bobine de tube  
Vakuumbutel Rollen  
Coil tube  
Bobina manga

Ref	€	Bobina	Micras	U.Venta
69052	14,10	28cmx5m 22cmx5m	105	1
69057	9,60	14cmx10m	105	6
69059	13,20	22cmx10m	105	1
69058	17,20	28cmx10m	105	1
69451	19,40	40cmx10m	105	1
69259	8,90	28cmx5m	105	1
69458	11,40	28cmx5m	90	1
69459	9,10	22cmx5m	90	6
69462	9,70	28cmx5m 22cmx5m	105	1
69463	8,60	22cmx10m	105	1
69464	10,80	28cmx10m	106	1



Lisas  
Flat



• Ideal para embutidos  
Ideal for sausages

## Bobina tubo vacío

Bobine de tube  
Vakuumbutel Rollen  
Coil tube  
Bobina manga

Ref	€	Bobina	Micras	U.Venta
69452	6,00	12cmx10m	105	6



**SAN**  
Plastic  
Contenedor  
Container

**PP**  
Polypropilene  
Tapa / Lid

## Set 3 botes vacío hogar + adaptador

3 boîte sous vide + Adaptateur  
3 Vakuumbehälter-Set + Adapter  
3 Shape canister set + Adapter  
Conj. 3 caixas vácuo domésticas + Adaptador

Ref	€	L	U.Venta
69051	36,30	0,7-1,4-2,0	1



Lisas  
Flat

Máquina de vacío / Vacuum Pack machine

	69116	69352	69530	69540	69353	69350	69050	69151	69357	69356	69355	69354	
<b>ROLLO · COIL TUBE</b> 	69052	28cmx5m/22cmx5m	Gofrada	✓	✓	✓	✓	✓	✓	✓	✓	✓	
	69057	14cmx10m	Gofrada	✓	✓	✓	✓	✓	✓	✓	✓	✓	
	69059	22cmx10m	Gofrada	✓	✓	✓	✓	✓	✓	✓	✓	✓	
	69058	28cmx10m	Gofrada	✓	✓	✓	✓	✓	✓	✓	✓	✓	
	69451	40cmx10m	Gofrada	✓	✓	✓	✓	✓	✓	✓	✓	✓	
	69259	28cmx5m	Gofrada	✓	✓	✓	✓	✓	✓	✓	✓	✓	
	69458	28cmx5m	Gofrada	✓	✓	✓	✓	✓	✓	✓	✓	✓	
	69459	22cmx5m	Gofrada	✓	✓	✓	✓	✓	✓	✓	✓	✓	
	69462	28cmx5m/22cmx5m	Lisa	✓									
	69463	22cmx10m	Lisa	✓									
	69464	28cmx10m	Lisa	✓									
	69053	16x20	Gofrada	✓	✓	✓	✓	✓	✓	✓	✓	✓	✓
	69054	20x30	Gofrada	✓	✓	✓	✓	✓	✓	✓	✓	✓	✓
	69055	24x36	Gofrada	✓	✓	✓	✓	✓	✓	✓	✓	✓	✓
69056	28x40	Gofrada	✓	✓	✓	✓	✓	✓	✓	✓	✓	✓	
69042	20x30	Gofrada	✓	✓	✓	✓	✓	✓	✓	✓	✓	✓	
69046	25x35	Gofrada	✓	✓	✓	✓	✓	✓	✓	✓	✓	✓	
69047	30x40	Gofrada	✓	✓	✓	✓	✓	✓	✓	✓	✓	✓	
69453	16x20	Gofrada	✓	✓	✓	✓	✓	✓	✓	✓	✓	✓	
69454	20x30	Gofrada	✓	✓	✓	✓	✓	✓	✓	✓	✓	✓	
69455	24x36	Gofrada	✓	✓	✓	✓	✓	✓	✓	✓	✓	✓	
69460	20x30	Lisa	✓										
69461	28x40	Lisa	✓										
69048(*)	40x60	Gofrada	✓	✓	✓	✓	✓	✓	✓	✓	✓	✓	
69452	12cmx10m	Gofrada	✓	✓	✓	✓	✓	✓	✓	✓	✓	✓	
69051	0,7 - 1,4 2,0 L			✓	✓	✓	✓	✓	✓	✓	✓	✓	
<b>SET 3 BOTES VACÍO 3 SHAPE CANISTER SET</b> 													

(\*) Apta para la máquina de vacío 69040 (descatalogada)

■ Bolsas y rollos para uso exclusivo del SOUS VIDE

# Colección SOUS VIDE

Inox  
18/10



- **Técnica culinaria que prima la calidad del producto.**
- **Resultados sorprendentes; alimentos más jugosos, tiernos y succulentos.**
- **Preserva las cualidades del producto y realza su sabor y textura.**

- Technique culinaire qui privilégie la qualité du produit.
- Résultats surprenants ; aliments plus juteux, tendres et succulents.
- Préserve les qualités du produit et améliore sa saveur et sa texture.

- Kochmethode zur Verfeinerung von Gargut.
- Lebensmittel sind erstaunlich saftig, zart und schmackhaft.
- Erhält die Eigenschaften des Produkts und verbessert seinen Geschmack und seine Textur.

- Culinary technique that enhances the quality of the product.
- Amazing results; juicier, more tender and more succulent food.
- Preserves the qualities of the product and enhances its flavour and texture.

- Técnica culinária que preserva a qualidade do produto.
- Resultados surpreendentes; alimentos mais ternos e succulentos.
- Preserva as qualidades do produto e aprimora seu sabor e textura.



## Cocinando paso a paso...



**Sazonamos los alimentos a cocinar**  
Assaisonner les aliments à cuisiner  
Gargut würzen  
Season the ingredients for cooking  
Condimentamos os alimentos a cozinhar

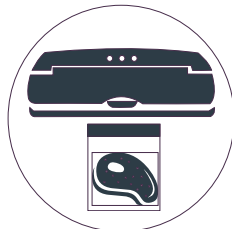

**Envasamos al vacío los alimentos**  
Conditionner les aliments sous vide  
Gargut vakuumverpacken  
Vacuum Pack the ingredients  
Embalamos os alimentos em vácuo

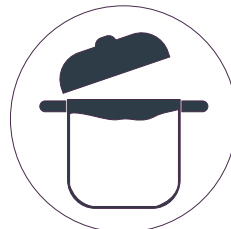

**Llenamos una olla con agua**  
Remplir une marmite d'eau  
Topf mit Wasser füllen  
Fill a cooking pot with water  
Enchemos uma panela com água



**Programamos el tiempo y la temperatura**  
Programmer la durée et la température  
Garzeit und -temperatur einstellen  
Programme in the time and the temperature  
Programamos o tempo e a temperatura

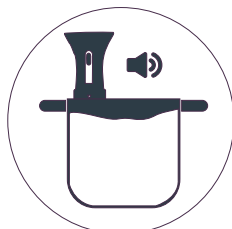



**Esperamos a que emita un pitido**  
Attendre l'émission d'un signal sonore  
Pfeifton abwarten  
Wait for the beep  
Esperamos que emita um aviso sonoro



**Introducimos la bolsa dentro de la olla**  
Introduire le sachet dans la marmite  
Vakuumbbeutel in den Topf geben  
Place the bag into the pot  
Introduzimos o saco com os alimentos dentro da panela



**Retiramos la bolsa y ¡A disfrutar!**  
Retirer le sachet et, bonne dégustation !  
Vakuumbbeutel entnehmen - Guten Appetit!  
Remove the bag and... Enjoy!  
Retiramos o saco... e a desfrutar!

SOUS VIDE	CIRCULACIÓN CIRCULATION	CAUDAL BOMBA PUMP FLOW	VOLUMEN (máx) VOLUME (max)	POTENCIA POWER	TEMPERATURA TEMPERATURE	DESVIACIÓN DESVIATION	ALT. MIN. DE AGUA MIN. WATER HEIGHT
 69192	<b>BOMBA</b> PUMP	6 L/min	40 L	1500 W	5°C - 99°C	0,1°C	12 cm
 69304	<b>BOMBA</b> PUMP	4,5 L/min	30 L	1200 W	5°C - 99°C	0,1°C	11 cm
 69302 - 69303	<b>EJE VENTILADOR</b> FAN SHAFT	N/A	15 L	1200 W	20°C - 90°C	1°C	6 cm

#### Características de nuestros SOUS VIDE portátiles:

**Resistencia de calentamiento:** Elemento encargado de calentar el agua. Cuanto mayor es la potencia de la resistencia, mayor es la capacidad de calentamiento del agua y menor el tiempo de espera hasta alcanzar la temperatura programable.

**Estabilidad de la temperatura:** Cuanto mayor sea la capacidad de la bomba (L/min), mayor será la estabilidad de la temperatura en el recipiente.

**Resolución:** Escalado de la temperatura a la que se puede programar el agua.

**Desviación de la temperatura:** La máxima diferencia entre temperatura programada y la temperatura del agua.

**Grado de protección contra el agua:** Grado de protección IPX7 frente a inmersiones temporales en agua. Esto garantiza que el aparato acepta la inmersión a 1 metro de profundidad durante 30 minutos sin que sea un peligro ni para el propio artículo ni para el usuario.

#### Caractéristiques de nos SOUS VIDE portables :

**Résistance de chauffe :** Élément chargé de chauffer l'eau. Plus la puissance de la résistance est importante, plus la capacité de chauffe de l'eau est grande et moins le temps d'attente pour atteindre la température programmable est long.

**Stabilité de la température :** Plus la capacité de la pompe est grande (L/min), plus la stabilité de la température dans le récipient sera importante.

**Résolution :** Progression de la température à laquelle peut être programmée l'eau.

**Écart de la température :** La différence maximale entre la température programmée et la température de l'eau.

**Degré de résistance à l'eau :** Degré de protection IPX7 face à des immersions temporaires dans l'eau. Cela garantit que l'appareil est étanche à 1 mètre de profondeur pendant 30 minutes sans que cela ne représente un danger ni pour l'appareil ni pour l'utilisateur.

#### Merkmale unserer tragbaren Vakuumgarer:

**Heizwiderstand:** Erhitzt das Wasser. Je größer die Widerstandsleistung desto größer ist die Heizkapazität und desto kürzer die Wartezeit, bis die voreingestellte Temperatur erreicht wird.

**Temperaturkonstanz:** Je größer die Pumpenkapazität (l/min) desto höher ist die Temperaturkonstanz im Behälter.

**Skalierung:** Temperaturskala für die mögliche Voreinstellung der Wassertemperatur.

**Temperaturabweichung:** Die maximale Differenz zwischen voreingestellter Temperatur und Wassertemperatur.

**Wasserschutzklasse:** Schutzklasse IPX7 gegen Eindringen von Wasser beim kompletten Eintauchen für begrenzte Zeit. D. h. das Gerät lässt sich sicher für 30 Minuten 1 Meter tief eintauchen, ohne dass dadurch für den Anwender oder das Gerät eine Gefahr besteht.

#### Characteristics of our portable SOUS VIDE:

**Heating element:** Component that heats the water The greater the power of the heating element the greater capacity it has for heating water and the less time you have to wait for the water to reach the programmable temperature.

**Temperature stability:** The greater the capacity of the pump (L/m) the better the temperature stability in the container.

**Resolution:** Scale of the temperatures the water can be programmed to.

**Temperature variation:** The maximum difference between the programmed temperature and the water temperature.

**Level of waterproofing protection:** IPX7 level protection against temporary immersion in water. This guarantees that the device can withstand being immersed 1 metre deep for 30 minutes with no risk to the device or the user.

#### Características dos nossos SOUS VIDE portáteis:

**Resistência de aquecimento:** Elemento destinado a aquecer a água. Quando maior for a potência da resistência, maior a capacidade de aquecimento da água, e menor o tempo de espera até alcançar a temperatura programável.

**Estabilidade da temperatura:** Quando maior for a capacidade da bomba (litros/min), maior a estabilidade da temperatura no recipiente.

**Resolução:** Escala de temperatura segundo a qual se pode programar a temperatura da água.

**Desvio da temperatura:** Diferença máxima entre a temperatura programada e a temperatura da água.

**Grau de proteção contra a água:** Grau de proteção IPX7 contra a imersão temporária em água, que garante que o aparelho suporta a imersão a 1 metro de profundidade durante 30 minutos sem que tal represente qualquer perigo para o aparelho ou para o utilizador.

Nutrientes  
**100 %**  
Nutrient



· Professional use ·

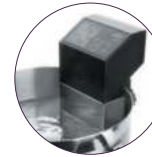

Protection Against  
Temporary immersion

**Anclaje sencillo y fácilmente almacenable y transportable. Se sujeta a cualquier tipo de olla, cazuela o cubeta que pueda contener 40 L**

Simple fastening and easy to store and transport. It is attached to any type of pot, saucepan or tray that can contain 40 L

**Bomba:**  
**La circulación mejora y garantiza una distribución uniforme del agua y la estabilidad de la temperatura**

Pump:  
Circulation improves and ensures uniform water distribution and temperature stability

## Sous Vide PRO

Sous Vide  
Sous Vide  
Sous Vide  
Sous Vide

Ref	€	W	U.Venta
69192	467,10	1500	1

Ref	Tensión/Voltage	Potencia/Power	Caudal bomba/Pump flow	Temperat./Temp.	Precisión/Precision	Capacidad/Cap.	Dimensiones/Sizes	Peso/Weight
69192	220-240 V; 50/60 Hz	1500 W	6 L/min.	5 - 99°C	0,1°C	40 L	14x14x33 cm	1,93 Kg

Nutrientes  
**100 %**  
Nutrient



· Semiprofessional use ·



Protection Against  
Temporary immersion

**Anclaje sencillo y fácilmente almacenable y transportable. Se sujeta a cualquier tipo de olla, cazuela o cubeta que pueda contener 30 L**

Simple fastening and easy to store and transport. It is attached to any type of pot, saucepan or tray that can contain 30 L

**Bomba:**  
**La circulación mejora y garantiza una distribución uniforme del agua y la estabilidad de la temperatura**

Pump:  
Circulation improves and ensures uniform water distribution and temperature stability

## Sous Vide PRECISE

Sous Vide  
Sous Vide  
Sous Vide  
Sous Vide

Ref	€	W	U.Venta
69304	310,50	1200	1

Ref	Tensión/Voltage	Potencia/Power	Caudal bomba/Pump flow	Temperat./Temp.	Capacidad/Cap.	Temp./Timer	Dimensiones/Sizes	Peso/Weight
69304	220-240 V; 50/60 Hz	1200 W	4,5 L/min.	5°C-99°C (Precision 0,1°C)	30 L	99 h	8x16x33 cm	1,40 Kg

Nutrientes  
**100 %**  
Nutrient



Por Miriam Garcia  
([invitadoinvierno.com](http://invitadoinvierno.com))  
en exclusiva para Lacor  
By Miriam Garcia  
([invitadoinvierno.com](http://invitadoinvierno.com))  
exclusively for Lacor

· Household use ·

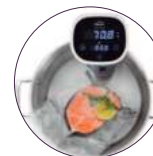

Protection Against  
Temporary immersion

**Anclaje sencillo y fácilmente almacenable y transportable. Se sujeta a cualquier tipo de olla, cazuela o cubeta que pueda contener 15 L**

Simple fastening and easy to store and transport. It is attached to any type of pot, saucepan or tray that can contain 15 L

## Sous Vide GOURMET

Sous Vide  
Sous Vide  
Sous Vide  
Sous Vide

	Ref	€	W	U.Venta
A	69302	205,20	1200	1
B	69303	205,20	1200	1

Ref	Tensión/Voltage	Potencia/Power	Temperature/Temp.	Capacidad/Capacity	Dimensiones/Sizes	Peso/Weight
69302	220-240 V; 50/60 Hz	1200 W	20-90°C (0,5°C)	15 L	Ø10x37 cm	1,0 Kg
69303	220-240 V; 50/60 Hz	1200 W	20-90°C (0,5°C)	15 L	Ø10x37 cm	1,0 Kg



**Rejilla divisoria de bolsas vacío**  
Split grill for separating bags

**Grifo de vaciado**  
Drainage tap



**Borde silicona para cierre hermético**  
Silicone edge for hermetic closure

## Cocedor Sous Vide

Cuiseur Sous Vide  
Sous-Vide-Kochapparat  
Sous Vide cooker  
Máquina de cozinhar a vácuo Sous Vide

Ref	€	W	L	U.Venta
69492	710,30	1600	17	1

- Cocina alimentos envasados al vacío a baja temperatura.
- Alimentos más tiernos, sabrosos y con la mejor textura.
- Resultados de alta calidad.
- Carcasa robusta fabricada íntegramente en acero inoxidable.
- Cierre hermético gracias a la tapa con borde de silicona.
- Incluye rejilla divisoria para la separación de las bolsas.
- Pantalla digital de tiempo y temperatura.
- Termostato de gran precisión ajustable: 30°C - 90°C (0,1 °C).
- Temporizador ajustable: 99 horas. 6 memorias. Capacidad: 17 litros.
- Filtro de seguridad para evitar impurezas en el sistema de recirculación del agua.
- Incorpora grifo de vaciado.

- Cuisine des aliments emballés sous vide à basse température.
- Des aliments plus tendres, plus savoureux et avec la meilleure texture.
- Résultats de haute qualité.
- Boîtier robuste entièrement fabriqué en acier inoxydable.
- Fermeture hermétique grâce au couvercle avec des bords en silicone.
- Inclut une grille de séparation des sacs.
- Écran numérique pour afficher le temps et la température.
- Thermostat réglable de haute précision : 30°C - 90°C (0,1 °C).
- Minuterie réglable : 99 heures. 6 mémoires. Capacité : 17 litres.
- Filtre de sécurité pour éviter les impuretés dans le système de recirculation de l'eau.
- Incorpore un robinet de vidange.

- Cooks vacuum packaged food at a low temperature.
- More tender, flavourful food with a better texture.
- High quality results.
- The robust body is made entirely of stainless steel.
- The lid with a silicone edge provides a hermetic closure.
- Split grill for separating bags included.
- Digital time and temperature screen.
- High precision adjustable thermostat: 30°C - 90°C (0.1 °C).
- Adjustable timer: 99 hours. 6 memories. Capacity: 17 litres.
- Safety filter for preventing contamination of the water recirculation system.
- Built in drainage tap.

Ref	Tensión/Voltage	Potencia/Power	Caudal bomba/Pump flow	Temperat./Temp.	Precisión/Precision	Capacidad/Cap.	Dimensiones/Sizes	Peso/Weight
69492	220-240 V; 50/60 Hz	1600 W	4 L/min	30°C - 99°C	0,1°C	17 L	62,5x36x30 cm	12 Kg



**Pantalla táctil: tiempo, temperatura, inicio y stop**  
Touch screen: time, temperature, start and stop



- Se emplean bolsas herméticas que se sumergen en el agua caliente por debajo del punto de ebullición.
- Pantalla táctil: tiempo, temperatura, inicio y stop.

- Des sachets hermétiques sont utilisés pour immerger les aliments dans l'eau chaude en-deçà du point d'ébullition, soit environ.
- Écran tactile : heure, température, start et stop.

- Es werden dicht abschließende Beutel verwendet, die in das heiße Wasser eingetaucht werden, unterhalb des Siedepunkts.
- Touchscreen: Zeit, Temperatur, Start und Stop.

- Uses hermetically sealed bags that are submerged into hot water below boiling point.
- Touch screen: time, temperature, start and stop.

- Utiliza bolsas herméticas, que se podem mergulhar em água quente abaixo do ponto de ebulição.
- Tela de toque: tempo, temperatura, start e stop.



## Sous Vide con tapa

Sous Vide avec couvercle  
Sous Vide mit Deckel  
Sous Vide with lid  
Sous Vide com tampa

Ref	€	W	L	U.Venta
69193	728,70	620	11 - 12,5	1

Ref	Tensión/Voltage	Potencia/Power	Caudal bomba/Pump flow	Temperat./Temp.	Precisión/Precision	Capacidad/Cap.	Dimensiones/Sizes	Peso/Weight
69193	220-240 V; 50/60 Hz	620 W	6 L/min	5 - 99°C	0,1°C	11 -12,5 L	27x29x42 cm	6,30 Kg



# Bolas aislamiento para SOUS VIDE



· Professional use ·

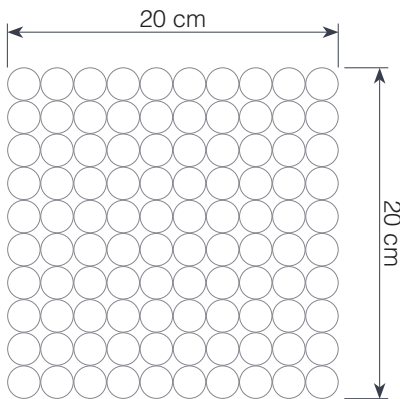

Área para 100 bolas (Ø2 cm) es de 400 cm<sup>2</sup>  
The area for 100 balls (Ø2 cm) is 400 cm<sup>2</sup>



- Bolas aislantes huecas y flotantes de polipropileno (PP), libres de BPA, para dispositivos sous-vide.
- Crean una capa de aislamiento evitando la pérdida de calor en un 75% y en un 90% la evaporación del agua.
- Permiten hervir agua durante horas sin tener que echar más, gracias al mínimo contacto entre agua y aire.
- Aumentan la precisión de la temperatura y ayudan a mantener los envasados al vacío bajo el agua.
- Reducen humos y riesgos de salpicaduras.
- Soportan hasta 150°C sin ningún problema.
- Compatibles con recipientes de todas las formas y tamaños.
- Se presenta con una práctica malla con cierre de cordón.

- Hollow, floating, BPA-free polypropylene (PP) insulation balls for sous-vide devices.
- Create an insulation layer reducing heat loss by 75% and water evaporation by 90%.
- Enable you to boil water for hours without having to add more, thanks to the minimal contact between water and air.
- Increase temperature accuracy and help keep vacuum packs submerged.
- Reduce smoke and the risk of splashes.
- Withstand up to 150°C without any problem.
- Compatible with containers of all shapes and sizes.
- Come with a handy mesh drawstring bag.

## Bolas aislantes para Sous Vide

Billes isolantes p/appareils de conditionnement Sous-Vide  
Isolationskugeln für Sous-Vide  
Sous Vide Insulation Balls  
Esferas aislantes para Sous Vide

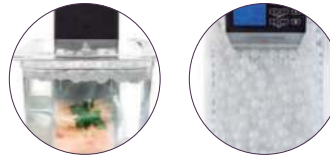

Perfecta capa de aislamiento  
Perfect insulation layer

Ref	€	Ø (cm)	Unidad	U.Venta
69219	28,20	2,0	100	1

# Rejilla para SOUS VIDE

Inox  
18/10

· Professional use ·

**Ideal para la sujeción en vertical de 4 bolsas**  
Its design is ideal for holding 4 vacuum bags



- Su diseño es ideal para la sujeción en vertical de 4 bolsas de vacío.
- Evita que las bolsas floten y entren en contacto con las paredes o fondo de las cubetas.
- Permite la circulación del agua entre las bolsas en todo momento, consiguiendo una cocción uniforme.
- Agiliza introducir y retirar las bolsas con facilidad.

- Sa forme est idéale pour faire tenir à la verticale 4 sachets pour sous vide.
- Évite que les sachets flottent et entrent en contact avec les parois ou le fond des cuves.
- Permet la circulation constante de l'eau entre les sachets, obtenant ainsi une cuisson uniforme.
- Permet d'introduire et de retirer les sachets plus facilement et rapidement.

- Ideale Form für die senkrechte Fixierung von 4 Vakuumbeuteln.
- Beutel bleiben unter Wasser und kommen nicht mit Wand oder Boden von Behältern in Kontakt.
- Ermöglicht die dauernde Wasserzirkulation zwischen den Beuteln und erzielt dadurch einen gleichmäßigen Kochvorgang.
- Vereinfacht das Einlegen und Entnehmen von Beuteln.

- Its design is ideal for holding 4 vacuum bags vertically.
- Prevents bags from floating and coming into contact with the sides or bottom of the container.
- Enables water to flow between the bags at all times, resulting in even cooking.
- Makes it quicker and easier to insert and remove the bags.

## Rack para Sous Vide

Rack pour Sous Vide  
Rack für Sous Vide  
Rack for sous vide  
Cremalheira para sous Vide

Ref	€	cm	Ø Varilla (mm)	U.Venta
67051	16,10	20x13,5x13,5	4	1

- Design ideal para suportar na vertical 4 sacos para cocção a vácuo.
- Evita que os sacos flutuem e entrem em contacto com as paredes ou com o fundo dos recipientes.
- Permite a circulação da água entre os sacos em todo o momento, para uma cocção uniforme.
- Permite introduzir e retirar facilmente os sacos.

# Colección SACACORCHOS



· Semiprofessional use ·

En tres pasos · In three steps



Autonomía  
Battery life

30-40

Botellas  
Bottles

## Sacacorchos BLACK LUXE

Tire-bouchon  
Korkenzieher  
Corkscrew  
Saca-rolhas

Ref	€	Ø (cm)	h (cm)	U.Venta
63056	38,30	4,8	22	1



- Diseño elegante, moderno y ergonómico: ideal para su uso profesional y de hogar.
- Funcionamiento rápido y sencillo tan solo pulsando un botón.
- Facilita la extracción del corcho de cualquier botella de vino en tan solo 6-8 segundos.
- Extrae el corcho suavemente y de forma silenciosa.
- Cabezal de extracción con iluminación led (63056 / 63057).
- Indicador de batería luminoso mediante LED: 4 niveles para indicar el nivel de energía (63056).
- Se carga mediante cable Micro USB.
- Incluye: cable cargador USB y descapsulador.

- Style élégant, moderne et ergonomique : idéal pour une utilisation aussi bien professionnelle que domestique.
- Fonctionnement rapide et simple en appuyant simplement sur un bouton.
- Facilite l'extraction du bouchon en liège de n'importe quelle bouteille de vin en 6-8 secondes seulement.
- Extraie le bouchon en liège lentement et silencieusement.
- Tête d'extraction avec éclairage led (63056 / 63057).
- Indicateur de batterie lumineux via LED : 4 niveaux pour indiquer le niveau de batterie (63056).
- Se charge à l'aide d'un câble Micro USB.
- Inclut : câble chargeur USB et décapsuleur.

- Elegant, modern and ergonomisch gefertigt – ideal für Haushalt und Gewerbe.
- Funktioniert schnell und einfach per Knopfdruck.
- Passend zum Entkorken der meisten Weinflaschen in nur 6–8 Sekunden.
- Zieht Korken mühelos und geräuschlos.
- Zugvorrichtung mit LED-Beleuchtung (63056 / 63057).
- LED-Batterieanzeige: 4 Energiestandniveaus (63056).
- Mit Micro-USB-Kabel.
- USB-Ladekabel und Kapselschneider inbegriffen.

En tres pasos · In three steps



Autonomía  
Battery life

30-40

Botellas  
Bottles

## Sacacorchos BLACK

Tire-bouchon  
Korkenzieher  
Corkscrew  
Saca-rolhas

Ref	€	Ø (cm)	h (cm)	U.Venta
63057	29,60	5	19	1



- Smart, modern and ergonomic design - ideal for professional and home use.
- Quick and easy push-button operation.
- Removes the cork from any bottle of wine in just 6-8 seconds.
- Removes the cork gently and quietly.
- Extraction head with led lighting (63056 / 63057).
- Battery indicator led: 4 energy level indicators (63056).
- Charging by Micro USB cable.
- Included: USB charger and decapsulator.

- Design elegante, moderno e ergonómico: ideal para uso profissional e doméstico.
- Funcionamento rápido e fácil com apenas premir um botão.
- Facilita a extração da rolha de qualquer garrafa de vinho em apenas 6-8 segundos.
- Extraí a rolha suavemente e sem ruído.
- Cabeça extratora com iluminação LED (63056 / 63057).
- Indicador luminoso de bateria LED: 4 níveis de energia (63056).
- Carga mediante um cabo Micro USB.
- Inclui: cabo de carga USB e abre-cápsulas.

En tres pasos · In three steps



Autonomía  
Battery life

30

Botellas  
Bottles

## Sacacorchos eléct. c/base cargador

Tire bouchon électrique a/support charge  
Korkenzieher, elektrisch mit Ladestation  
Electric corkscrew w/charger base  
Saca-rolhas Eléctrico com Base carregador

Ref	€	W	cm	U.Venta
63031	40,70	1,2	Ø12x32	1



Autonomía  
Battery life

30-40

Botellas  
Bottles



## Sacacorchos c/base cargador BLACK

Tire bouchon électrique avec support charge  
Korkenzieher, elektrisch mit Ladestation  
Electric corkscrew with charger base  
Saca-rolhas eléctrico com base carregador

Ref	€	W	cm	U.Venta
63054	43,70	18	Ø5x25	1



# Colección armarios refrigeradores **TERMOELÉCTRICOS**



· *Semiprofessional use* ·



- Diseñados para refrigerar eficazmente botellas de vino y otras bebidas.
- La temperatura interior puede ser ajustada mediante el control electrónico.
- Puerta con cámara de cristal templado y sistema de apertura con tirador.
- Estantes extraíbles.
- Silencioso y sistema antivibratorio.
- Pies regulables en altura.
- **NOTA:** deje suficiente espacio en la parte trasera (mínimo 5 cm) para permitir la salida del calor y una adecuada ventilación.
- **Vinoteca termoelectrica:** el control y regulación de la temperatura dependerá de la temperatura ambiental del establecimiento.

- Conçue pour refroidir efficacement les bouteilles de vin et autre boissons.
- La température intérieure peut être réglée à l'aide du contrôle électronique.
- Porte en verre trempé et système d'ouverture avec poignée.
- Étagères extractibles.
- Silencieuse et système anti-vibrations.
- Pieds réglables en hauteur.
- **REMARQUE :** laissez suffisamment d'espace dans la partie arrière (minimum 5 cm) pour permettre la sortie de la chaleur et une bonne ventilation.
- **Cave à vin thermoélectrique :** le contrôle et le réglage de la température dépendront de la température ambiante de l'établissement.

- Für die leistungsstarke Kühlung von Wein und anderen Getränken.
- Die Innentemperatur lässt sich elektronisch einstellen.
- Hartglas-Tür mit Schiebegriff.
- Ausziehbare Holzablagen.
- Leiser Betrieb mit Vibrationsschutz.
- Höhenverstellbare Füße.
- Zur Gewährleistung der Wärmeabstrahlung und Belüftung genügend Abstand (5 cm) zur Wand halten.
- **Thermoelektrische vinothek:** steuerung und regulierung der temperatur abhängig von der umgebungstemperatur der einrichtung.

- Designed to effectively cool bottles of wine and other beverages.
- The internal temperature can be adjusted using the electronic control.
- Door with tempered glass chamber and handle-operated opening system.
- Pull-out shelves.
- Silent, anti-vibration system.
- Height-adjustable legs.
- **NOTE:** leave enough space at the back (minimum 5 cm) to allow heat to escape and adequate ventilation.
- **Thermoelectric wine cooler:** the temperature control and regulation depends on the ambient temperature of the location.

- Desenhados para refrigerar eficazmente garrafas de vinho e outras bebidas.
- Controlo eletrónico regulável da temperatura interior.
- Porta com câmara de vidro temperado e sistema de abertura com puxador.
- Estantes extraíveis.
- Silencioso e com sistema anti-vibrações.
- Patas reguláveis em altura.
- **NOTA:** recomendamos deixar um espaço suficiente entre o armário e a parede de trás (mínimo de 5 cm) para permitir a saída do calor e uma ventilação adequada.
- **Vinoteca termoelectrica:** o controlo e a regulação da temperatura dependerá da temperatura ambiente do local.



**Puerta inoxidable**  
Rust-proof door



**Control electrónico de temperatura**

Electronic temperature control

**Luz en el interior**

Light inside

## Armarios refrigeradores INOX

Refridisseur à vin  
Thermo Weinkühler  
Thermo wine cooler  
Armário refrigerador

Ref	€	W	Botellas/Bottles	U.Venta
69072	413,20	70	28	1

Ref	Tensión/Voltage	Botellas/Bottles	Potencia/Power	Capacidad/Cap.	Temperature/Temp.	Consumo/Consump.	Dimensiones/Sizes A x B x C	Peso/Weight
69072	220-240 V; 50/60 Hz	28	70 W	75 L	12 - 18°C	182 kWh/annum	46x53x73 cm	17,2 Kg

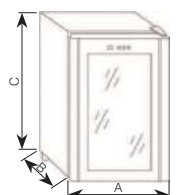

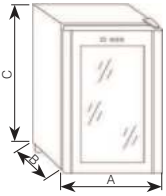

## B Doble cámara · Double camera



Doble cámara · Double camera

Display temperatura · Temperature display

Control de temp. (+/-) · Temp. touch control

Control de luz (ON/OFF) · Light control (ON/OFF)



## Armarios refrigeradores BLACK

Refrigerateur à vin

Thermo Weinkühler

Thermo wine cooler

Armário refrigerador

	Ref	€	W	Botellas	U.Venta
A	69175	352,30	75	28	1
B	69185	420,50	100	18	1

Ref	Tensión/Voltage	Botellas/Botiles	Potencia/Power	Capacidad/Cap.	Temperature/Temp.	Consumo/Consump.	Dimensiones/Sizes A x B x C	Peso/Weight
69175	220-240 V; 50/60 Hz	28	75 W	65 L	12 - 18°C	182 kWh/annum	48x54x74 cm	19,3 Kg
69185	220-240 V; 50/60 Hz	18	100 W	48 L	8 - 18°C / 12 - 18°C	197 kWh/annum	36x65x50 cm	16,0 Kg

new



## Armarios refrigeradores

Refrigerateur à vin

Thermo Weinkühler

Thermo wine cooler

Armário refrigerador

	Ref	€	W	Botellas	U.Venta
A	69670	385,60	70	8	1
B	69671	413,90	70	12	1
C	69672	459,50	70	18	1
D	69673	516,30	70	28	1

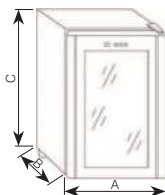

Ref	Tensión/Voltage	Botellas/Botiles	Potencia/Power	Capacidad/Cap.	Temperature/Temp.	Consumo/Consump.	Dimensiones/Sizes A x B x C	Peso/Weight
69670	220-240 V; 50 Hz	8	70 W	23 L	11 - 18°C	190 kWh/annum	26x49,5x48 cm	10,0 Kg
69671	220-240 V; 50 Hz	12	70 W	31 L	11 - 18°C	129 kWh/annum	34,5x48x47 cm	13,0Kg
69672	220-240 V; 50 Hz	18	70 W	50 L	11 - 18°C	146 kWh/annum	34,5x49x67 cm	17,0 Kg
69673	220-240 V; 50 Hz	28	70 W	71 L	11 - 18°C	179 kWh/annum	45x52x72,5 cm	24,3 Kg

# Colección armarios refrigeradores con compresor **MERLOT**



· Semiprofessional use ·

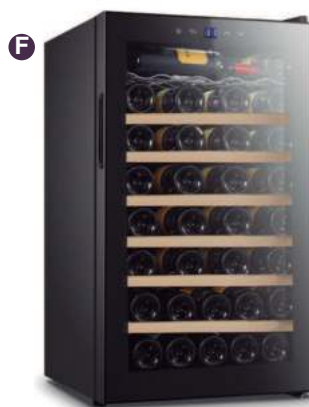

- Armario refrigerador con sistema de enfriamiento por compresor.
- Diseñados para refrigerar eficazmente botellas de vino y otras bebidas.
- La temperatura interior puede ser ajustada mediante el control electrónico.
- Acabado en acero inoxidable y cristal negro.
- Puerta con cámara de cristal templado y sistema de apertura con tirador.
- Estantes extraíbles acabados en madera.
- Silencioso y sistema antivibratorio.
- Pies regulables en altura.
- **NOTA:** deje suficiente espacio en la parte trasera (mínimo 5 cm) para permitir la salida del calor y una adecuada ventilación.

- Cave à vin avec système de refroidissement par compresseur.
- Conçue pour refroidir efficacement les bouteilles de vin et autre boissons.
- La température intérieure peut être réglée à l'aide du contrôle électronique.
- Finitions en acier inoxydable et verre noir.
- Porte avec chambre en verre trempé et système d'ouverture avec poignée.
- Étagères extractibles avec finition en bois.
- Silencieuse et système anti-vibrations.
- Pieds réglables en hauteur.
- **REMARQUE:** laissez suffisamment d'espace dans la partie arrière (minimum 5 cm) pour permettre la sortie de la chaleur et une bonne ventilation.

- Schrank mit Kompressorkühlung, use
- Für die leistungsstarke Kühlung von Wein und anderen Getränken.
- Die Innentemperatur lässt sich elektronisch einstellen (5°C-18°C).
- Ausführung in Edelstahl und schwarzem Glas.
- Hartglas-Tür mit Schiebegriff.
- Ausziehbare Holzablagen.
- Leiser Betrieb mit Vibrationsschutz.
- Höhenverstellbare Füße.
- **HINWEIS:** Zur Gewährleistung der Wärmeabstrahlung und Belüftung genügend Abstand (5 cm) zur Wand halten.

- Refrigerated cabinet with compressor cooling system.
- Designed to effectively cool bottles of wine and other beverages.
- The internal temperature can be adjusted using the electronic control.
- Stainless steel and black crystal finish.
- Door with tempered glass chamber and handle-operated opening system.
- Wood finish pull-out shelves.
- Silent, anti-vibration system.
- Height-adjustable legs.
- **NOTE:** leave enough space at the back (minimum 5 cm) to allow heat to escape and adequate ventilation.

- Armário refrigerador com sistema de refrigeração por compressor.
- Desenhados para refrigerar eficazmente garrafas de vinho e outras bebidas.
- Controle eletrônico regulável da temperatura interior.
- Acabados em aço inoxidável e vidro negro.
- Porta com câmara de vidro temperado e sistema de abertura com puxador.
- Estantes extraíveis.
- Silencioso e com sistema anti-vibrações.
- Patas reguláveis em altura.
- **NOTA:** recomendamos deixar um espaço suficiente entre o armário e a parede de trás (mínimo de 5 cm) para permitir a saída do calor e uma ventilação adequada.

## Armario refrigerador de compresor

Refridisseur à vin à compresseur  
Weinkühler mit Kompressor  
Compressor type wine cooler  
Refrigerador de vinho do tipo compresso

	Ref	€	W	Botellas	U.Venta	
<b>A</b>	69700	519,60	85	12	1	new
<b>B</b>	69701	534,80	85	12	1	new
<b>C</b>	69702	828,50	85	18	1	new
<b>D</b>	69239	437,20	85	18	1	
<b>E</b>	69238	466,20	85	28	1	
<b>F</b>	69703	833,90	85	51	1	new



Display luminoso de control de temperatura digital  
Luminous digital temperature control display

Ref	Tensión/Voltage	Botellas/Bottles	Potencia/Power	Temperatura Temp.	Consumo Consump.	Ruido Noise	Refrigerante Refrigerant	Dimensiones/Sizes	Peso/Weight
69700	220-240 V ; 50/60 Hz	12	85 W	5°C-18°C	107 kWh/annum	45 dB	R600A	44x47x53 cm	18,0 Kg
69701	220-240 V ; 50/60 Hz	12	85 W	5°C-18°C	136 kWh/annum	45 dB	R600A	25x45x79 cm	17,0 Kg
69702	220-240 V ; 50/60 Hz	18	85 W	5°C-18°C	145 kWh/annum	46 dB	R600A	34,5x48x83 cm	22,3 Kg
69239	220-240 V ; 50/60 Hz	18	85 W	5°C-18°C	120 kWh/annum	42 dB	R600A	34,5x45x77 cm	19,5 Kg
69238	220-240 V ; 50/60 Hz	28	85 W	5°C-18°C	189 kWh/annum	42 dB	R600A	43x45x84 cm	24,0 Kg
69703	220-240 V ; 50/60 Hz	51	85 W	5°C-18°C	156 kWh/annum	47 dB	R600A	49,5x56,5x85 cm	34,0 Kg

# Refrigeradores MINIBAR



· Professional use ·



**No introduzca alimentos o bebidas calientes**  
Do not introduce hot food or drinks

**Diseñado para refrigerar y mantener los alimentos y bebidas frescos**  
Designed to refrigerate and maintain fresh food and drinks

**Puerta reversible**  
Reversible door

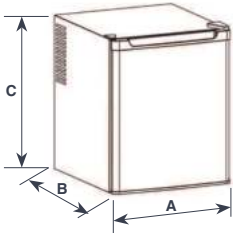

## Refrigerador minibar

Mini frigo bar  
Minibar Kühlschrank  
Mini-bar refrigerator  
Refrigerador mini-bar

	Ref	€	W	U.Venta
<b>A</b>	69070	256,90	70	1
<b>B</b>	69075	256,90	70	1

Ref	Tensión/Voltage	Potencia/Power	Cap./Capac.	Temperatura/Temp.	Consumo/Cons.	Ruido/Noise	Refrig./Rerig.	Dimensiones/Sizes A x B x C	Peso/Weight
69070	220-240 V; 50/60 Hz	70 W	38 L	6°C - 22°C	96 kWh/annum	26dB	R600a (27g)	43x41x51 cm	9,0 Kg
69075	220-240 V; 50/60 Hz	70 W	38 L	6°C - 22°C	96 kWh/annum	26dB	R600a (27g)	43x41x51 cm	9,0 Kg

**REFRIGERADOR TERMOELÉCTRICO: el control y regulación de la temperatura, dependerá de la temperatura ambiental del establecimiento**  
THERMOELECTRIC REFRIGERATOR: temperature control and regulation depend on the ambient temperature of the establishment

# Colección MÁQUINAS DE HIELO



· Professional use ·



- Ideal para utilizarlo en bares, restaurantes, hoteles, etc.
- Cuerpo fabricado en acero inoxidable 18/10 de alta calidad.
- Construcción robusta.
- Enfriamiento fuerte y constante.
- Aislamiento interior de alta calidad, mantiene el hielo congelado durante mucho tiempo.
- Gran capacidad de fabricación de hielo (>20 kg/24h).
- Forma de cubo de hielo: dedal.
- Parada de producción cuando la bandeja de cubitos de hielo está llena.
- Interruptor de encendido / apagado.
- Incluye: Tubos de instalación y pala para el hielo.

- Ideal for use in bars, restaurants, hotels, etc.
- Body made of high quality 18/10 stainless steel.
- Robust construction.
- Strong and constant cooling.
- High quality interior insulation, keeps ice frozen for a long time.
- Great ice making capacity (> 20 kg / 24h).
- Ice cube shape: thimble.
- Production stop when the ice cube tray is full.
- On / off switch.
- Includes: Installation tubes and ice scoop.

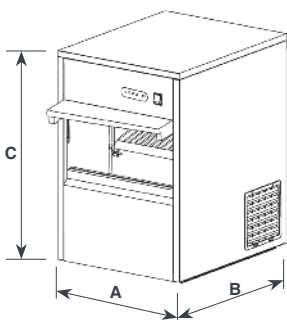
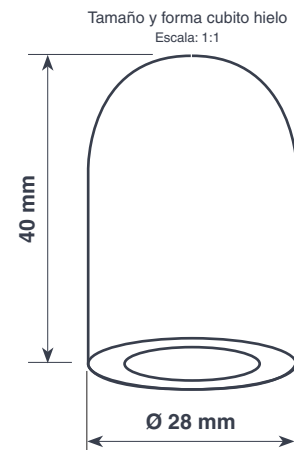

## Máquina de hielo PRO

Machine à fabriquer des glaçons  
Eiswürfelmaschine  
Ice maker  
Máquina de gelo

Ref	€	W	U.Venta
69320	1.070,00	170	1



Perfecta para una producción de grandes volúmenes

Perfect for large volume production

Contenedor de 4 kg de capacidad

Container 4 kg capacity



Ref	Tensión/Voltage	Potencia/Power	Cap. contenedor hielo Ice container cap.	Producción/Product.	Cubo/Ice (Sizes)	Dimensiones/Sizes A x B x C	Peso/Weight
69320	220-240 V; 50 Hz	170 W	4 Kg	>20 Kg/24h	Ø28x40 mm	38x48x59 cm	27 Kg



**En 10 o 12 minutos, obtendrá cubitos de hielo**  
In 10 to 12 minutes you will have ice cubes.

**Dispone de programador**  
It has a programmer

**Encender y listo**  
Plug and play



**Inox**  
**18/10**

### Máquina de hielo ICE

Machine à glaçons  
Eiswürfelmaschine  
Ice cubes maker  
Maquina de fazer gelo

Ref	€	W	L	U.Venta
69314	413,30	150	1,50	1



**9 cubitos por ciclo (cada ciclo es de 8 min aproximadamente)**  
9 cubes per cycle (each cycle is approximately 8 min.)

**Ventana transparente**  
Transparent window



**ABS PP**

Plastic Polypropilene

### Máquina de hielo NORD

Machine à glaçons  
Eiswürfelmaschine  
Ice cubes maker  
Maquina de fazer gelo

Ref	€	W	L	U.Venta
69340	270,10	100	2,20	1

- **Funcionamiento sencillo; rellena manualmente el depósito de agua y obtén cubitos de hielo en pocos minutos. Sin necesidad de toma de agua.**
- **Depósito de agua de 1,50 L (69314) / 2,2 L (69340) de capacidad.**
- **Produce hasta 10 - 15 kg por día (69314).**
- **Produce hasta 12 kg por día y 9 cubitos en cada ciclo (69340).**
- **Forma del cubito de hielo: bala (Ø26x30 mm).**
- **Ciclo de producción totalmente automático y silencioso.**
- **Detección por infrarrojos, se detendrá automáticamente al detectar el contenedor lleno.**
- **Alarma acústica cuando el compartimento de hielo está lleno o si se necesita más agua.**
- **Incluye pala para la extracción de los cubitos de hielo.**
- **Drenaje en la base, no requiere instalación o desagüe.**

- Fonctionnement simple : remplissez le réservoir d'eau et obtenez des glaçons en quelques minutes. Ne nécessite pas d'évacuation d'eau.
- Réservoir d'eau d'une capacité de 1,50 L (69314) / 2,2 L (69340).
- Produit jusqu'à 10 - 15 kg par jour (69314).
- Produit jusqu'à 12 kg par jour et 9 glaçons à chaque cycle (69340).
- Forme du glaçon : cylindrique (Ø26x30 mm).
- Cycle de production entièrement automatique et silencieux.
- Détection par infra-rouges ; la machine s'arrêtera automatiquement si elle détecte que le conteneur est plein.
- Alarme sonore lorsque le compartiment à glaçons est plein ou lorsqu'il faut remettre de l'eau.
- Inclut une pelle pour prendre les glaçons.
- Drainage à la base, ne requiert pas d'installation spécifique ou de tuyau d'écoulement.

- Einfache Bedienung. Wasser in Tank füllen und im Nu sind die Eiswürfel fertig. Keine Wasserentnahme erforderlich.
- 1,50 Liter (69314) / 2,2 Liter (69340) Wassertank.
- Macht 10 - 15 kg Eiswürfel pro Tag (69314).
- Macht 12 kg Eiswürfel pro Tag, 9 Eiswürfel pro Durchlauf (69340).
- Eiswürfelform: Kugel (Ø 26 x 30 mm).
- Ruhiger Automatikbetrieb.
- Infrarotsensor stoppt das Gerät bei vollem Eiswürfelbehälter.
- Akustisches Alarmsignal bei vollem Eiswürfelbehälter oder leerem Wassertank.
- Mit Eisschaufel.
- Mit Abfluss auf der Unterseite (keine Installation erforderlich).

- Easy to use. Fill the water tank manually and get ice cubes in just a few minutes. Doesn't need its own plumbing.
- Water tank with 1.50 L (69314) / 2.2 L (69340) capacity.
- Makes up to 10 - 15 kg a day (69314).
- Makes up to 12 kg a day and 9 ice cubes in every cycle (69314).
- Ice cube shape: bullet (Ø 26 x 30 mm).
- Totally automatic and silent production cycle.
- Infrared detection. It stops automatically when it detects a full container.
- It makes a sound when the ice compartment is full or if more water is needed.
- A blade is included for removing the ice cubes.
- The draining in the base does not require installation or a drain.

- Funcionamento simples: encha manualmente o depósito de água e obtenha cubos de gelo em poucos minutos. Não requer conexão a uma torneira de água.
- Depósito de água de 1,50 litros(69314) / 2,2 litros (69340) de capacidade.
- Produz até 10 - 15 kg por dia (69314).
- Produz até 12 kg por dia e 9 cubos de gelo por ciclo (69314).
- Cubos de gelo em forma de bala (Ø 26x30 mm).
- Ciclo de produção totalmente automático e silencioso.
- Deteção por infravermelhos: a máquina para automaticamente ao detetar o recipiente cheio.
- Alarme acústico quando o compartimento de gelo está cheio e quando é necessário acrescentar água.
- Inclui uma pá para retirar os cubos de gelo.
- Abertura de drenagem na base da máquina, que não requer instalação nem canalização.

**Tamaño y forma cubito hielo**  
Escala: 1:1

Ice cube size and shape  
Scale: 1:1

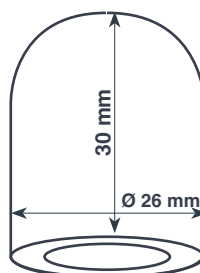

Ref	Tensión/Voltage	Potencia/Power	Capacidad/Capacity	Contenedor/Cont.	Producción/Product.	Dimensiones/Sizes	Peso/Weight
69314	220-240 V; 50/60 Hz	150 W	1,50 L	0,6 Kg	10-15 Kg/24h	32x32x38 cm	11,30 Kg
69340	220-240 V; 50/60 Hz	100 W	2,20 L	0,7 Kg	12 Kg/24h	36x24x33 cm	8,00 Kg



# Colección **PICADORAS DE HIELO**

Inox  
18/10



· *Semiprofessional use* ·



- Ideal para la preparación de cócteles, combinados, granizados, limonadas, refrescos, postres fríos, etc.
- Una manera simple y rápida de obtener hielo picado en 30 segundos.
- Cuerpo de acero inoxidable.
- Anclajes de seguridad en el recipiente de recogida.
- Todas las partes desmontables son aptas para lavavajillas.
- 4 patas con ventosas, aporta estabilidad a la hora del uso.

- Idéal pour la préparation de cocktails, mélanges, granités, limonades, rafraîchissements, desserts froids, etc.
- Une façon simple et rapide d'obtenir de la glace pilée en 30 secondes.
- Corps en acier inoxydable.
- Ancrages de sécurité sur le récipient d'accueil.
- Toutes les parties démontables sont aptes pour aller au lave-vaisselle.
- 4 pieds avec ventouses qui confèrent une stabilité lors de l'utilisation.

- Ideal für die Zubereitung von Cocktails, Drinks, Sorbets, Limonaden, Erfrischungsgetränke, kalten Nachspeisen usw.
- Eine einfache und schnelle Art, um innerhalb von 30 Sekunden durch.
- Gehäuse aus rostfreiem Stahl.
- Sicherheitsverriegelungen am Auffangbehälter.
- Alle abbaubaren Teile sind für den Geschirrspüler geeignet.
- 4 Füße mit Saugnapfen für erhöhte Stabilität im Betrieb.

- Ideal for preparing cocktails, drinks, slushies, lemonade, soft drinks, cold desserts, etc.
- A simple quick way to make crushed ice in 30 seconds.
- Stainless steel body.
- Safety anchors on the crushed ice container.
- All removable parts are dishwasher safe.
- 4 legs with suction cups, provides stability in operation.

- Ideal para preparar cocktails, combinados, granizados, limonadas, refrescos, sobremesas frías, etc.
- Uma maneira simples e rápida de obter gelo picado em 30 segundos.
- Corpo de aço inoxidável.
- Fixações de segurança no recipiente de recolha.
- Todas as partes desmontáveis são aptas para máquinas de lavar louça.
- 4 patas com ventosas, para maior estabilidade durante a utilização.

**Cuchilla de acero inoxidable**  
Stainless steel blade



## Picadora de hielo **MARBLE**

Broyeur à glaçons  
Eis-Crusher  
Ice crusher  
Picadora de gelo

Ref	€	W	L	U.Venta
69310	85,90	100	0,50	1

**Compatible con las máquinas de hielo LACOR**  
Compatible with LACOR ice machines



**Embudo de llenado extraíble**  
Removable cone

## Picadora de hielo **PRO**

Broyeur à glace  
Eis-Crusher  
Ice crusher  
Picadora de gelo

Ref	€	W	L	Producción (Kg/h)	U.Venta
69313	113,60	60 - 80	2,80	12	1

Ref	Tensión/Voltage	Potencia/Power	Cap. hielo/Ice cap.	Capacidad/Capacity	Embudo/Funnel	Dimensiones/Sizes	Peso/Weight
69310	220-240 V; 50/60 Hz	100 W (5.500 r.p.m.)	-	0,50 L	-	18x20,5x46,5 cm	5,10 Kg
69313	220-240 V; 50/60 Hz	60-80 W	12 Kg/h	2,80 L	Ø14 cm	17x29x47,5 cm	11,30 Kg

# Máquina enfriacopas FREEZE



· Professional use ·

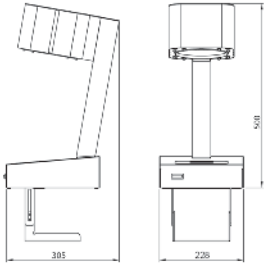

- Gracias a su diseño, la FREEZE es perfecta para cualquier local ya que se adapta a todo tipo de superficies, ocupando el mínimo espacio.
- Se puede ubicar donde se precise según las necesidades de cada ocasión.
- Perfecta para negocios de mucha actividad.
- Fabricado en acero inoxidable.
- Conexión a botella de CO<sub>2</sub> de 28 ó 36 Kg.
- Contador de operaciones.
- Luces tipo LED de activación por impulsos de gas.
- Sistema de conexión a botella con sistema de seguridad incluido.

- Thanks to its design, the FREEZE is perfect for any local adapts to all types of surfaces, taking up a minimum of space.
- Can be placed where required according to the needs of each occasion.
- Perfect for busy business.
- Made of steel stainless.
- Connection to CO<sub>2</sub> bottle of 28 or 36 Kg.
- Counter operations.
- Lights activation type LED by impulses from gas.
- Bottle with safety system including system.

**Precios NO sujetos al sistema de descuentos habitual de LACOR**  
 Prix non soumis au système habituel de remises de LACOR  
 Prices not subject to the usual discount system of LACOR

## Máquina enfriacopas FREEZE

Machine à givrer les verres  
 Gläser-Kühlmaschine  
 Glass cooler machine  
 Máquina para enfriar copas

Ref	€	W	U.Venta
69300	3.155,00	25	1

Ref	Tensión/Voltage	Potencia/Power	Programas/Program.	Dimensiones/Sizes	Peso/Weight
69300	220-240 V; 50/60 Hz	25 W	4	22,8x30,5x 50 cm	12 Kg

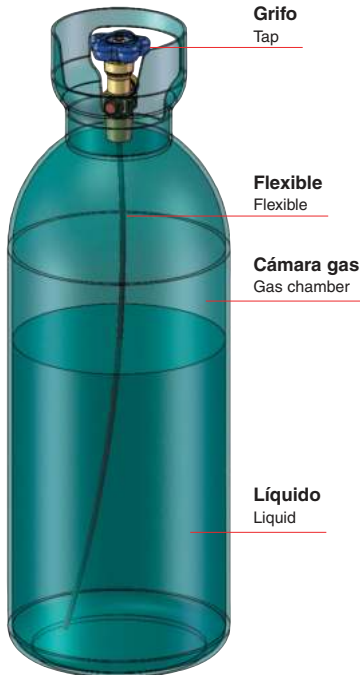

### ¿Qué tipo de gas utilizamos?

El gas que utilizan nuestras máquinas es Gas carbónico alimentario en estado líquido. El Dióxido de Carbono, también denominado óxido de carbono (IV), gas carbónico y anhídrido carbónico, CO<sub>2</sub>, es insípido, incoloro, inodoro y no inflamable.

Aunque la forma más común en que se encuentra el CO<sub>2</sub> es en estado gaseoso, bajo determinadas condiciones se puede encontrar también en estado líquido o sólido. Estas botellas están destinadas para uso médico y alimentario y lo que las diferencia del resto es que en su interior cuenta con una sonda que extrae el líquido criogénico que al liberarse alcanza una temperatura de -79,8 C°

### Seguridad LACOR

- 1.- Funcionamiento a base de gas carbónico líquido alimentario
- 2.- Control de presión de gas. Control de temperatura de congelación del gas ajustable de -8 a -55°C
- 3.- Fabricado en Acero Inoxidable de uso médico y alimentario. Todos los conductos interiores están fabricados en AISI-316 garantizando las óptimas condiciones alimentarias e higiénico-sanitarias
- 4.- Adaptable a cualquier tamaño de copa o vaso
- 5.- Exclusivo sistema de seguridad patentado y control para presiones superiores a 100 bar

### Nuestros artículos cumplen las siguientes normativas:

- 1.- Directiva 2006/95/CE de seguridad eléctrica
- 2.- Directiva 2006/108/CE de compatibilidad electromagnética
- 3.- Directiva 2006/42/CE de máquinas
- 4.- Norma UNE-EN ISO 12100-1:2004
- 5.- Norma UNE-EN ISO 12100-2:2004
- 6.- Norma EN 614-1:1996
- 7.- Norma UNE-EN ISO 13850:2007
- 8.- Norma UNE-EN 60335-1

### What type of gas do we use?

Our machines use liquid food grade Carbon dioxide gas. Carbon Dioxide, also called carbon oxide (IV), carbonic gas and carbon anhydride, CO<sub>2</sub>, is insipid, colourless, odourless and not flammable. Although the most common state of CO<sub>2</sub> is gaseous, under certain conditions it can also be found in liquid or solid state. These bottles are used for medical and food uses and they are different from the rest in that their interiors have a probe that extracts the cryogenic liquid which when freed reaches temperatures of -79.8 °C

### LACOR Safety

- 1.- Operability based on liquid food grade carbon dioxide gas
- 2.- Control of gas pressure. Control of freezing temperature of the gas adjustable from -8 to -55 °C
- 3.- Manufactured from Stainless Steel for medical and food use. All the internal conducts are manufactured from AISI-316 guaranteeing optimal food and hygienic-health condition
- 4.- Adaptable to any size of glass
- 5.- Exclusive patented safety system and control for pressures above 100 bar

### Our articles fulfil the following standards:

- 1.- Directive 2006/95/CE for electrical safety
- 2.- Directive 2004/108/EC for electromagnetic compatibility
- 3.- Directive 2006/42/CE for machinery
- 4.- UNE-EN ISO 12100-1:2004 Standard
- 5.- UNE-EN ISO 12100-2:2004 Standard
- 6.- EN 614-1:1996 Standard
- 7.- UNE-EN ISO 13850:2007 Standard
- 8.- UNE-EN 60335-1 Standard



# Pizarras LED



· Professional use ·

**8 colores para usar con la pizarra eléctrica Led**  
8 colors to use with the Led electric board

**No tóxicos, fácil de limpiar**  
Non toxic, easy to clean



- Sistema de gran impacto visual. Crea tus propios diseños.
- Muy fácil de usar, dibuja o escribe encima con los rotuladores fluorescentes especiales, pero NUNCA con la pizarra encendida.
- Se borra con un trapo.
- Se pueden colocar tanto vertical como horizontalmente.
- Consume muy poco.

- Système d'un grand impact visuel. Concevez vos propres créations.
- Très facile à utiliser, dessinez ou écrivez dessus avec les feutres fluorescents spéciaux mais JAMAIS lorsque le tableau est allumé.
- S'efface avec un chiffon.
- Peut être installé aussi bien à la verticale qu'à l'horizontale.
- Consomme très peu.

- System mit Blickfang-Effekt. Schaff Dein eigenes Design.
- Ganz einfach im Gebrauch, schreib oder zeichne mit den fluoreszierenden Spezialstiften, aber NIE wenn die Tafel eingeschaltet ist.
- Mit Lappen auswischen.
- Lässt sich sowohl waagrecht als auch senkrecht aufhängen.
- Gering im Verbrauch.

- Very eye-catching system. Create your own designs.
- Very easy to use; draw or write on it with the special fluorescent markers, but NEVER when the blackboard is on.
- Wipes clean with a cloth.
- Can be placed both vertically and horizontally.
- Consumes very little power.

- Sistema de grande impacto visual, para criar os seus próprios desenhos.
- Muito fácil de utilizar, permite desenhar ou escrever em cima com os rotuladores fluorescentes especiais. NUNCA escreva no quadro com este ligado.
- A escrita apaga-se com um trapo.
- Podem colocar-se vertical ou horizontalmente.
- Baixo consumo.

## Rotuladores fluorescentes 8 colores

Marqueurs fluorescents 8 couleurs  
8-Farben fluoreszierenden marker  
Fluorescent markers 8 colors  
Maracadores fluiescentes 8 cores

Ref	€	cm	U.Venta
39161	33,20	10	1

**Crea tus propios diseños**  
Create your own designs

- Sistema llamativo**  
Eye-catching system
- Gran impacto visual**  
Great visual impact
- Limpieza muy sencilla**  
Cleaning very simple



**NO incluidos**  
NOT included

## Pizarra LED

Tableau lumineux à LED  
LED Tafel  
Blackboard LED  
Ardósia LED

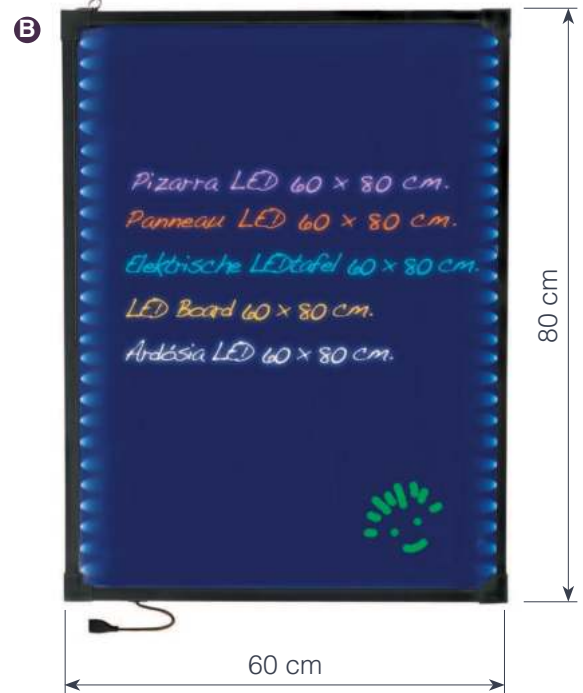
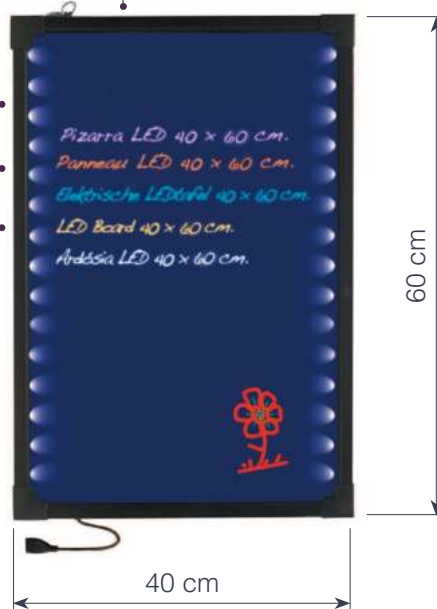

	Ref	€	W	U.Venta
<b>A</b>	39140	102,70	2	1
<b>B</b>	39160	141,00	2	1

Ref	Tensión/Voltage	Potencia/Power	Funcioned/Functions	Dimensiones/Sizes	Peso/Weight
39140	220-240 V; 50/60 Hz	2 W	38	40x60 cm	2,35 Kg
39160	220-240 V; 50/60 Hz	2 W	38	60x80 cm	4,50 Kg

# Básculas PROFESIONALES

Inox



· Professional use ·

**Cabezal orientable y abatible**  
Retractable, swivelling head

**Cuerpo aluminio fundido**  
Cast aluminium case

**Plataforma inoxidable 53x44cm**  
St. Steel platform, 53x44 cm

**Patas de apoyo regulables**  
Adjustable support feet



- **Batería interna recargable (autonomía 15 días).**
- **Visor de nivel, planitud.**
- **Avisador acústico de sobrecarga.**
- **Teclado intuitivo y de fácil uso. Funciones de calculadora.**
- **Acumulación de importes.**
- **Unidades de medida (Kg, oz, Libras). Función de tara.**
- **Libro de instrucciones en 7 idiomas.**

- Batterie interne rechargeable (Autonomie 15 jours).
- Indicateur de niveau, de planité.
- Avertisseur acoustique de surcharge.
- Clavier intuitif d'utilisation facile. Fonctions de calculatrice.
- Accumulation de sommes.
- Unités de mesure: (Kg, oz, Livres). Fonction de tare.
- Mode d'emploi en 7 langues.

- Integrierte aufladbare Batterie (Leistungsdauer 15 Tage).
- Nivellierung-, Planheitsanzeige.
- Akustischer Warnton bei Überlastung.
- Berührungsempfindliche, einfach anzuwendende Tastatur.
- Rechenfunktionen. Kumulierung mehrerer Beträge.
- Gewichtseinheiten: (Kg, oz, Pfund). Tara- funktion.
- Handbuch in 7 Sprachen.

- Rechargeable internal battery (Last 15 days).
- Level and fatness indicator.
- Overload alarm.
- Intelligent and easy-to-use keyboard. Calculator functions. Total counter.
- Measurement units: (Kg, oz, pounds). Tare function.
- Instructions book in 7 languages.

- **Batería interna recarregável (Autonomia 15 dias).**
- **Vídor de nível, plnitude.**
- **Avisador acústico de sobrecarga.**
- **Teclado intuitivo e de fácil uso. Função de calculadora.**
- **Cumulação de portes.**
- **Unidades de medida (Kg, oz, pounds). Função de tara.**
- **Livro de instruções em 7 idiomas.**

## Báscula electrónica con base cuadrada 150 Kg (20 g)

Balance professionnel électronique 150 Kgs. (20g)  
Elektronische Küchenwaage mit rechteckigem Oberteil 150 Kg (20g)  
Electronic bench scale w/square base 150 Kg (20g)  
Balança electrónica com base quadrada 150 Kg (20 g)

Ref	€	U.Venta
61700	1.146,70	1

Ref	Tensión/Voltage	Tara/Tare	Dimensiones/Sizes	Peso/Weight
61700	220-240 V / 50-60 Hz	150 Kgr (20 g)	49x75x90 cm	45 Kg

CERTIF.: 89/336/ECC, 91/263/EEC, 92/31/ECC, 93/68/EEC en 50 082 - 1:1992

**Doble display (Delante / Detrás)**  
Double display (Front / Back)

**Plataforma inoxidable 30x24cm**  
St. Steel platform, 30x24 cm

**Plataforma extraíble**  
Removable platform

**Patas de apoyo regulables**  
Adjustable support feet

**Teclado intuitivo y de fácil uso**  
Intelligent and easy-to-use keyboard



- **Batería interna recargable (autonomía 15 días).**
- **Visor de nivel, planitud.**
- **Avisador acústico de sobrecarga.**
- **Funciones cambio.**
- **Seis memorias programables.**
- **Unidades de medida (Kgs., Oz., Libras). Función de tara.**
- **Libro de instrucciones en 7 idiomas.**

- Batterie interne rechargeable (Autonomie 15 jours).
- Indicateur de niveau, de planité.
- Avertisseur acoustique de surcharge.
- Fonctions changement.
- Six mémoire programmable.
- Unités de mesure: (Kgs., Oz, Livres). Fonction de tare.
- Mode d'emploi en 7 langues.

- Integrierte aufladbare Batterie (Leistungsdauer 15 Tage).
- Nivellierung-, Planheitsanzeige.
- Akustischer Warnton bei Überlastung.
- Tauschfunktionen.
- Sechs programmierbare Speicher.
- Gewichtseinheiten: (Kgrs., Oz, Prfund). Tara- funktion.
- Handbuch in 7 Sprachen.

- Rechargeable internal battery (Last 15 days).
- Level and fatness indicator.
- Overload alarm.
- Change functions.
- Six programmable memories.
- Measurement units: (Kgrs, Oz, pounds). Tare function.
- Instructions book in 7 languages.

- **Batería interna recarregável (Autonomia 15 dias).**
- **Vídor de nível, plnitude.**
- **Avisador acústico de sobrecarga.**
- **Função de mudança.**
- **Seis memória programável.**
- **Unidades de medida (Kgrs, Oz, pounds). Função de tara.**
- **Livro de instruções em 7 idiomas.**

## Báscula electrónica con base cuadrada

Balance de cuisine électronique  
Elektronische Küchenwaage mit rechteckigem Oberteil  
Electronic scale w/square base  
Balança electrónica com base quadrada

Ref	€	Tara
61716	472,20	15kg/5g
61730	508,10	30kg/10g

Ref	Tensión/Voltage	Potencia/Power	Tara/Tare	IP	Dimensiones/Sizes	Peso/Weight
61716	220-240 V / 50-60 Hz	0,2 W (max)	15 Kgr (5 g)	IPX 54	30x32x12 cm	4,60 Kg
61730	220-240 V / 50-60 Hz	0,2 W (max)	30 Kgr (10 g)	IPX 54	30x32x12 cm	4,60 Kg

CERTIF.: OIML R76 Clase III, 60/384/ECC

# Afiladores ELÉCTRICOS



· Household use ·



## Afilador de cuchillos eléctrico TitanPRO

Affûteuse de couteaux électrique  
Elektrische Schärfmaschine  
Electric knife sharpener  
Afiador de facas electrónico

Ref	€	U.Venta
69341	39,10	1

### Ruedas de Alundum blanco

White alundum wheel



- Permiten mantener los utensilios en perfecto estado.
- Diseño elegante, acabado metalizado.
- Dispone de diferentes ranuras para poder afilar distintos tipos de utensilios como cuchillos, tijeras o destornilladores de punta plana.
- El motor gira a la velocidad óptima para que el afilado de los utensilios sea preciso y duradero.
- 100% seguro: en su base se incluyen cuatro ventosas de fijación para evitar que el afilador se mueva durante su uso.

- Permet de maintenir les ustensiles en parfait état.
- Design élégant, finition métallisée.
- Dispose de différents rainures pour pouvoir aiguiser différents types d'ustensiles tels que des couteaux, des ciseaux ou des tournevis.
- Le moteur tourne à une vitesse optimale pour que l'aiguisage des ustensiles soit précis et durable.
- 100% antidérapant : sa base possède quatre ventouses de fixation pour éviter que l'aiguiser bouge pendant son utilisation.

- Elektrischer Messerschärfer hält Utensilien in einwandfreiem Zustand.
- Elegantes Design in Metalloptik.
- Schlitz zum Schärfen von Messern, Scheren oder Schlitzschraubendreher.
- Optimale Motordrehzahl für einen präzisen und langhaltenden Schliff.
- 100 % rutschfest dank vierfacher Saugbefestigung, die ein Bewegen des Schärfers bei Gebrauch verhindert.

- Keeping kitchen utensils in perfect condition.
- Elegant design, metallic finish.
- It has different grooves for sharpening different utensils, like knives, scissors and flat-head screwdrivers.
- The motor spins at the optimal speed for precise and long lasting sharpening.
- 100% safe. There are four suction cups on the base to keep the sharpener from moving during use.

- Permiten manter os seus utensilios em perfeito estado.
- Desenho elegante e acabamento metalizado.
- Com diferentes ranhuras para afiar diferentes tipos de utensílios, como facas, tesouras e chaves de parafusos.
- O motor gira a uma velocidade ótima, para um afiar preciso e durável.
- 100% antideslizante: a base possui quatro ventosas de fixação para evitar que o afilador se mova durante a sua utilização.

## Afilador de cuchillos eléctrico ROND

Affûteuse de couteaux électrique  
Elektrische Schärfmaschine  
Electric knife sharpener  
Afiador de facas electrónico

Ref	€	U.Venta
69141	32,10	1

### Cuchillos lisos y dentados

Smooth and serrated knives



### Cuchillos lisoa

Smooth knives



### Rejilla salida viruta

Chip outlet grid

## Afilador de cuchillos eléct. PRO

Affûteuse de couteaux électrique  
Elektrische Schärfmaschine  
Electric knife sharpener  
Afiador de facas electrónico

Ref	€	U.Venta
69261	124,20	1



Fase 1: Alta abrasividad · High abrasiveness  
Fase 2: Afilado fino · Thin sharp  
Fase 3: Micro-afilado · Micro-sharp

## Afilador de cuchillos eléctrico MOUSE

Affûteuse de couteaux électrique  
Elektrische Schärfmaschine  
Electric knife sharpener  
Afiador de facas electrónico

Ref	€	U.Venta
60359	49,10	1

Ref	Tensión/Voltage	Potencia/Power	Dimensiones/Sizes	Peso/Weight
69341	220-240 V / 50-60 Hz	60 W	17x8x10 cm	0,60 Kg
69141	220-240 V / 50 Hz	60 W	13,5x15x9 cm	0,64 Kg
69261	220-240 V / 50-60 Hz	80 W	32x11,5x10 cm	2,20 Kg
60359	220-240 V / 50-60 Hz	60 W	16x11x7,5 cm	0,56 Kg

# Esterilizadores de CUCHILLOS

Inox



· Professional use ·

IP21



· Esterilización mediante rayos ultravioletas germicidas que transforman el oxígeno en ozono, destruyendo bacterias, hongos y virus.

· Sterilisation by ultraviolet germicidal rays that transform oxygen into ozone, destroying bacteria, fungi and viruses.



## Armario esterilizador cuchillos ultravioleta

Armoire à stériliser

Sterilisierungsschank

Knife sterilization

Armário esterilizador facas

	Ref	€	W	U.Venta	
<b>A</b>	39012	656,10	15	1	10 cuchillos · 10 Knifes
<b>B</b>	39124	879,50	15	1	20 cuchillos · 20 Knifes

Ref	Cuchillos/Knives	Tensión/Voltage	Potencia/Power	Reloj/Timer	Dimensiones/Sizes	Peso/Weight
39012	10	230 V; 50/60 Hz	15 W	120 min	36x13x57 cm	4,785 Kg
39124	20	230 V; 50/60 Hz	15 W	120 min	45x13x57 cm	5,630 Kg

# Colección MATAMOSQUITOS



· Professional use ·



- Perfecto para el uso en lugares públicos como bares, restaurantes, hoteles, etc.
- Su elegante diseño es ideal para darle un toque moderno a cualquier espacio.
- Discreto, silencioso y seguro, sin descarga eléctrica.
- Es una alternativa perfecta a los insecticidas y matamosquitos tradicionales.
- No contamina (sin químicos ni venenos); evita la fragmentación del insecto y la dispersión de las bacterias.
- La luz ultravioleta atrae todo tipo de insectos voladores los cuales se eliminan mediante el papel adhesivo.
- El papel adhesivo se sustituye en segundos, ofreciendo una limpieza fácil y rápida.

- Parfait pour une utilisation dans des lieux publics tels que des bars, restaurants, hôtels, etc.
- Son style est idéal pour apporter une touche moderne à tout type d'espace.
- Discret, silencieux et sûr, sans décharge électrique.
- Il s'agit d'une excellente alternative aux insecticides et tue-mouches traditionnels.
- Ne pollue (pas de produits chimiques ou de poisons), évite la fragmentation de l'insecte et la dispersion des bactéries.
- La lumière ultraviolette attire tout type d'insectes volants, qui sont éliminés à travers le papier adhésif.
- Le remplacement du papier adhésif s'effectue en quelques secondes, permettant ainsi un nettoyage facile et rapide.

- Ideal zum Einsatz in öffentlichen Bereichen wie Gaststätten, Restaurants, Hotels, usw.
- Sein elegantes Design verleiht ihm ein modernes Aussehen in allen Räumen.
- Diskret, leise und sicher, ohne elektrische Entladungen.
- Eine perfekte Alternative zu herkömmlichen Insekten- und Fliegenbekämpfungsmitteln.
- Es erfolgt keine Kontaminierung (keine Chemikalien oder Gifte), Insekt nicht fragmentiert und die Bakterien nicht verbreitet werden.
- Das UV-Licht zieht alle möglichen fliegenden Insekten an, die mithilfe des Klebpapiers eliminiert werden.
- Der Austausch des Klebpapiers erfolgt sekundenschnell für eine einfache und schnelle Reinigung.

- Perfect for public places like bars, restaurants, hotels, etc.
- It's elegant design is perfect for giving a modern touch to any space.
- It's discrete, quiet and safe and doesn't produce electric shocks.
- It's a perfect alternative to insecticides and traditional.
- Doesn't pollute (no chemicals or poisons), it doesn't crush insects and spread bacteria.
- The UV light attracts all kinds of flying insects which get eliminated using adhesive paper.
- The adhesive paper can be changed in seconds for fast and easy cleaning.

- Perfeito para uso em lugares públicos, como bares, restaurantes, hotéis, etc.
- O seu design elegante é ideal para dar um toque moderno a qualquer espaço.
- Discreto, silencioso e seguro, sem descargas elétricas.
- Uma alternativa perfeita aos insecticidas e mata-moscas tradicionais.
- Não contamina (sem produtos químicos ou venenos), evitando a fragmentação dos insetos e a dispersão das bactérias.
- A luz ultravioleta atrai todo o tipo de insetos voadores, que são eliminados pelo papel adesivo.
- O papel adesivo substitui-se em segundos, proporcionando uma limpeza fácil e rápida.



**Sin descargas eléctricas**  
Doesn't produce electric shocks

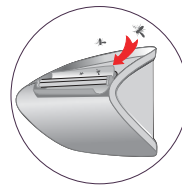

## Matamosquitos DECOR

Anti-moustiques  
Fliegenfänger  
Moskito killer  
Mata mosquitos

Ref	€	W	Área protección	U.Venta
39135	102,50	35	60 m2	1

## Set de 3 láminas adhesivas

Ensemble de 3 feuilles adhesives  
Set von 3 Klebe Folie  
Set of 3 adhesives sheet  
Conjunto de 3 folhas adesivas

Ref	€	U.Venta
R39135C	13,30	1

\* Se recomienda reemplazar el papel adhesivo cada 10 días pero si más de 2/3 del papel está cubierto de moscas, reemplace el papel  
It is recommended that you replace the sticky fly paper every 10 days but if more than 2/3 of the paper is covered in flies, replace the paper

Ref	Tensión/Voltage	Potencia/Power	Área protec./Prot. area	Lámparas/Lamps	L. cable./Cord length	Dimensiones/Sizes	Peso/Weight
39135	220-240 V; 50/60 Hz	35 W	60 m2	2 x 15W	115 cm	42x23,8x17,3 cm	1,36 Kg

Vida útil de trabajo  
Functional lifespan  
**20.000 h**



- Diseñado para lugares públicos como bares, restaurantes, hoteles, etc.
- Dispone de lámparas UV-A de alta calidad y con una longitud de onda óptima para atraer a todo tipo de insectos voladores.
- Una alternativa perfecta a los insecticidas, libre de contaminación e inocuo para los humanos.
- Dispone de rejilla metálica de alto voltaje en el interior donde los insectos son electrocutados con una tasa de eliminación instantánea y del 100%.
- Bandeja desmontable recoge insectos en la parte inferior, facilita la limpieza.
- Se instala fácilmente. Incluye dos cadenas para colgar.

- Conçu pour des lieux publics tels que les bars, les restaurants, les hôtels, etc.
- Dispose de lampes UV-A de grande qualité avec une longueur d'onde optimale pour attirer tout type d'insectes volants.
- Une alternative parfaite aux insecticides, sans contamination et inoffensif pour les humains.
- Dispose d'une grille métallique de haut voltage à l'intérieur où les insectes sont électrocutés avec un taux d'élimination instantanée de 100%.
- Plateau démontable ramasse-insectes dans la partie inférieure, qui facilite le nettoyage.
- Installation facile. Inclut deux chaînes pour l'accrocher.

- Konzipiert für öffentliche Bereiche wie Kneipen, Restaurants, Hotels usw.
- Verfügt hochwertige, leistungsstarke UV-A-Lampen mit einer optimalen Wellenlänge, um alle möglichen fliegenden Insekten anzuziehen.
- Eine perfekte Alternative zu Insektenbekämpfungsmitteln, schadstofffrei und ungiftig für Menschen.
- Im Inneren befindet sich ein unter Hochspannung stehendes Metallgitter, an dem die Insekten per Stromschlag sofort und zu 100 % getötet werden.
- Demontierbare Insekten-Auffangwanne im Inneren, um die Reinigung zu erleichtern.
- Einfache Installation. Enthält zwei Ketten zum Aufhängen.

- Designed for public spaces such as bars, restaurants, hotels, etc.
- Powerful high-quality UV-A lamps with an optimal wavelength to attract all types of flying insects.
- A perfect alternative to insecticides, free from contamination and harmless to humans.
- It has an internal high-voltage metal grill that instantaneously electrocutes insects with a 100% elimination rate.
- Removable tray that collects insects on the bottom, facilitating cleaning.
- Installs easily. Includes two chain for hanging.

- Desenhado para lugares públicos, como bares, restaurantes, hotéis, etc.
- Incorpora potentes lâmpadas de UV-A, de alta qualidade, com um comprimento de onda capaz de atrair todo o tipo de insetos voadores.
- Uma alternativa perfeita aos inseticidas, não contaminante e inócua para os seres humanos.
- Com rede metálica de alta voltagem no interior, que eletrocuta instantaneamente 100% dos insetos.
- Bandeja recolhadora de insetos desmontável localizada na parte inferior, que facilita a limpeza do aparelho.
- Fácil de instalar. Inclui duas correntes para pendurar.



## Matamosquitos LUCE

Anti-moustiques  
Fliegenfänger  
Moskito killer  
Mata mosquitos

	Ref	€	W	Área protección	U.Venta
<b>A</b>	39126	90,30	11	150 m <sup>2</sup>	1
<b>B</b>	39127	110,50	13	300 m <sup>2</sup>	1

Protección  
Protection  
**IPX0**



## Matamosquitos CAPTER

Anti-moustiques  
Fliegenfänger  
Moskito killer  
Mata mosquitos

	Ref	€	W	Área protección	U.Venta
<b>A</b>	39134	75,00	26	80 m <sup>2</sup>	1
<b>B</b>	39136	83,90	36	100 m <sup>2</sup>	1

Ref	Tensión/Voltage	Potencia/Power	Bombillas/Bulbs	Area protec./Prot. area	Descarga/Shock	Dimensiones/Sizes	Peso/Weight
39126	220-240 V; 50/60 Hz	11 W	16 UV-A LED	150 m <sup>2</sup>	4000 V	33x10x36,3 cm	1,50 Kg
39127	220-240 V; 50/60 Hz	13 W	20 UV-A LED	300 m <sup>2</sup>	4000 V	47x10x36,3 cm	3,00 Kg
39134	220-240 V; 50/60 Hz	26 W	2x10W UV-A LED	80 m <sup>2</sup>	2000 V	38,5x9x31 cm	2,75 Kg
39136	220-240 V; 50/60 Hz	36 W	2x15W UV-A LED	100 m <sup>2</sup>	2000 V	49,5x9x31 cm	3,15 Kg



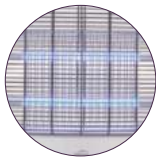

**2 lámparas LED**  
2 LED lights

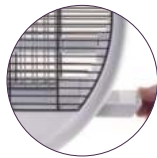

**Bandeja extraíble**  
Removable tray

**Incluye cuerda para colgar**  
Includes a cord for hanging

**Vida útil de trabajo: 10.000 h**  
Useful working life: 10,000 h



**PP**

Polypropylene

## Matamosquitos WHITE

Anti-moustiques  
Mückenfalle  
Mosquito killer  
Mata-mosquitos

Ref	€	W	Área protección	U.Venta
39129	64,90	3,5	50 m2	1

Ref	Tensión/Voltage	Potencia Power	Longitud onda Wavelength	Descarga eléct. Electric shock	Área protección Protection area	Vida útil Useful life	Cable Cord	Dimensiones Sizes	Peso Weight
39129	220-240 V; 50/60 Hz	3,5 W	398 m	2500 V	50 m2	10.000 h	1,50 m	Ø36,6x8,3 cm	1,40 Kg

- **Uso interior: hogar, oficinas, hoteles, locales comerciales, restaurantes, etc.**
- **Dispone de 2 lámparas LED de alta calidad y con una longitud de onda óptima para atraer a todo tipo de insectos voladores.**
- **Una alternativa perfecta a los insecticidas, libre de contaminación e inocuo para los humanos.**
- **Rejilla metálica de 2500V en el interior donde los insectos son electrocutados.**

- Utilisation en intérieur : logements, bureaux, hôtels, boutiques, restaurants, etc.
- Dispose de 2 ampoules LED de grande qualité et d'une longueur d'onde optimale pour attirer tout type d'insectes volants.
- Une alternative parfaite aux insecticides, sans contamination et inoffensive pour les humains.
- Dispose d'une grille métallique de 2500V à l'intérieur, où les insectes sont électrocutés.

- Für Haushalt, Büro, Läden, Restaurants und weitere Innenbereiche.
- Wellenlänge der beiden hochwertigen LED-Leuchten zieht alle möglichen Fluginsekten an.
- Insektenbekämpfungsmittel ohne Schadstoffe und für Menschen harmlos.
- Eingebaute 2.500 V Gitterplatte tötet Insekten durch Stromschlag.

- Designed for indoor use: Home, offices, hotels, businesses, restaurants, etc.
- It has 2 high quality LED lights with an optimal wavelength for attracting all kinds of flying insects.
- It's a perfect alternative to insecticide because it's pollution free and innocuous to humans.
- It has a 2500 V metal screen inside where insects are electrocuted.

- Uso interior em moradias, escritórios, hotéis, estabelecimentos comerciais, restaurantes, etc.
- Dispõe de 2 lâmpadas LED de alta qualidade, com um comprimento de onda otimizado para atrair todo o tipo de insetos voadores.
- Uma alternativa perfeita aos insecticidas, não contaminante e inócua para as pessoas .
- Equipada com uma grelha metálica de 2500 V no interior, que electrocuta os insetos.

**Soporte colgador**  
Hanger support

**Luz ultravioleta**  
Ultraviolet light

**Bandeja recoge mosquitos**  
Tray collection mosquitoes

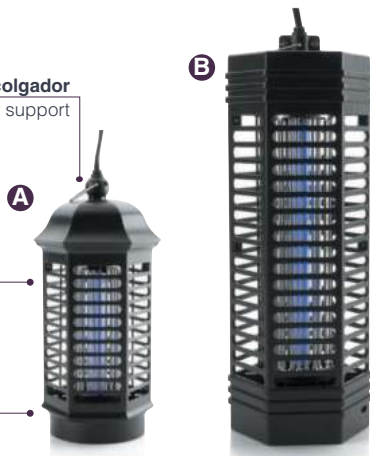

**Soporte colgador**  
Hanger support

**Luz ultravioleta**  
Ultraviolet light

**Ventilador**  
Ventilator

**Bandeja recoge mosquitos**  
Tray collection mosquitoes



## Matamosquitos NET

Appareil anti-moustiques noir  
Fliegenfänger, schwarz  
Moskito killer black  
Mata mosquitos preto

	Ref	€	W	Área protección	U.Venta
<b>A</b>	39138	20,90	4	40 m <sup>2</sup>	1
<b>B</b>	39139	23,60	6	60 m <sup>2</sup>	1

## Matamosquitos BLACK

Appareil anti-moustiques  
Fliegenfänger  
Moskito killer  
Mata mosquitos

	Ref	€	W	Área protección	U.Venta
	39133	35,60	13	50 m <sup>2</sup>	1

Ref	Tensión/Voltage	Potencia/Power	Area protec./Prot. area	Dimensiones/Sizes	Peso/Weight
39138	220-240 V; 50/60 Hz	4 W	40 m <sup>2</sup>	Ø12x25 cm	350 g
39139	220-240 V; 50/60 Hz	6 W	60 m <sup>2</sup>	Ø12x33 cm	875 g
39133	220-240 V; 50/60 Hz	13 W	50 m <sup>2</sup>	Ø27x27 cm	950 g

# Colección CALENTADORES ELÉCTRICOS



· Professional use ·



- Ideal para bares y restaurantes con mesas en el exterior.
  - Funciona mediante lámparas de calentamiento halógeno infrarrojos.
  - Malla protectora para evitar quemaduras.
  - Resistente al polvo y agua (IP).
- Idéal pour les bars et les restaurants ayant des tables à l'extérieur.
  - Fonctionne à l'aide de lampes de réchauffement halogènes par infrarouges.
  - Maillage de protection pour éviter les brûlures.
  - Résistant à la poussière et à l'eau (IP).
- Ideal für Bars und Restaurants mit Tischen im Freien.
  - Arbeitet mit infraroten Halogenheizlampen.
  - Gitter schützt vor Verbrennungen.
  - Staub- und Wasserabweisend.
- Ideal for bars and restaurants with tables outside.
  - Powered by infrared halogen heating lamps.
  - Protective mesh to prevent burns.
  - Dust and water resistant (IP).
- Ideal para bares e restaurantes com mesas no exterior.
  - Funciona com lâmpadas de aquecimento de halógeno por infravermelhos.
  - Malha de proteção para evitar queimaduras.
  - Resistente ao pó e à água (IP).

¿Qué es la clasificación IP? · What is the IP classification?

## IP 54

1º dígito; protección contra objetos y polvo 1st digit; protection against objects and dust	2º dígito; protección contra líquidos 1st digit; protection against liquids
<p><b>IP0:</b> Sin protección · Without protection</p> <p><b>IP1:</b> Protección contra objetos con un Ø mayor de 50 mm Protection against objects with Ø greater than 50 mm</p> <p><b>IP2:</b> Protección contra objetos con un Ø mayor a 12 mm Protection against objects with Ø greater than 12 mm</p> <p><b>IP3:</b> Protección contra objetos con un Ø mayor a 2,5 mm Protection against objects with Ø greater than 2,5 mm</p> <p><b>IP4:</b> Protección contra objetos con un Ø mayor a 1 mm Protection against objects with Ø greater than 1 mm</p> <p><b>IP5:</b> Protección contra polvo · Protection against dust</p> <p><b>IP6:</b> A prueba de polvo · Testing against dust</p>	<p><b>IPX0:</b> Sin protección · Without protection</p> <p><b>IPX1:</b> Protección contra gotas de agua Protection against water drops</p> <p><b>IPX2:</b> Protección contra el goteo de agua con una inclinación de 15° · Protection against dripping water with an inclination of 15°</p> <p><b>IPX3:</b> Protección contra pulverización Protection against spray</p> <p><b>IPX4:</b> Protección contra salpicaduras · Splash protection</p> <p><b>IPX5:</b> Protección contra chorros de agua Protection against water jets</p> <p><b>IPX6:</b> Protección contra aguaceros Protection against downpours</p> <p><b>IPX7:</b> Protección contra la inmersión durante un tiempo determinado · Protection against immersion for a certain time</p> <p><b>IPX8:</b> Protección contra permanencia bajo agua Protection against permanence under water</p>

# CALENTADORES PIE



**AL**  
Aluminium

## Calentador eléctrico pie

Chauffage électrique sur pied  
Standheizstrahler  
Free standing electric heater  
Aquecedor elétrico de pé

Ref	€	W	U.Venta
69414	454,90	2100	1

- Desmontable en 3 partes, lo cual facilita el almacenaje de larga duración.
- El cabezal del calentador tiene un radio de giro de 40°.
- Base redonda y pesada para una mejor estabilidad y seguridad.
- Seguro y respetuoso con el medio ambiente, no produce ni ruidos ni olores.
- Incluye unos accesorios para el anclaje del calefactor.

- Démontable en 3 parties, ce qui facilite le rangement de longue durée.
- La tête du chauffage a un rayon de rotation de 40°.
- Base ronde et lourde pour une meilleure stabilité et sécurité.
- Sûr et respectueux de l'environnement, ne produit ni bruit ni odeurs.
- Inclut des accessoires pour l'ancrage du chauffage.

- Can be disassembled into 3 parts for easy long term storage.
- The head of the heater has a 40° rotation radius.
- Heavy round base for better stability and safety.
- Safe and environmentally friendly. Does not produce noise or odours.
- Includes accessories for anchoring the heater.

Área de calentamiento · Heating area

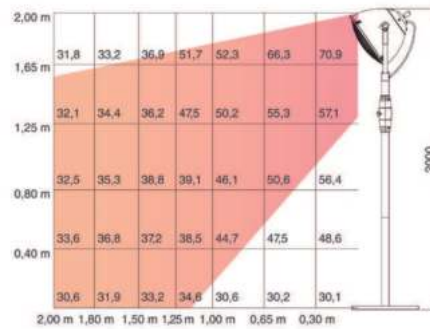

Ref	Tensión/Voltage	Potencia/Power	Lámparas Lamps	N. calentamiento Heating levels	Ángulo de giro Angle of rotation	Nivel protección Protection level	Dimensiones Sizes	Peso/Weight
69414	220-240 V ; 50/60 Hz	2100 W	2	3 (900/1200/2100W)	40°	IP54	45x45x210 cm	17,0 Kg

Área de calentamiento · Heating area

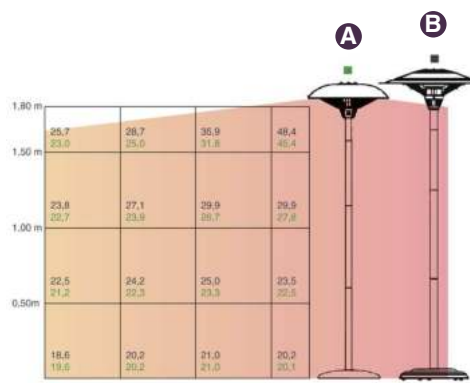

**AL Inox**  
Aluminium Barra/Stick

## Calentador pie

Rechauffeur pied  
Heizung m/Ausziehbarer Fuß  
Lamp  
Aquecedor com pé

Ref	€	U.Venta
<b>A</b> 69410	343,90	1
<b>B</b> 69411	407,70	1

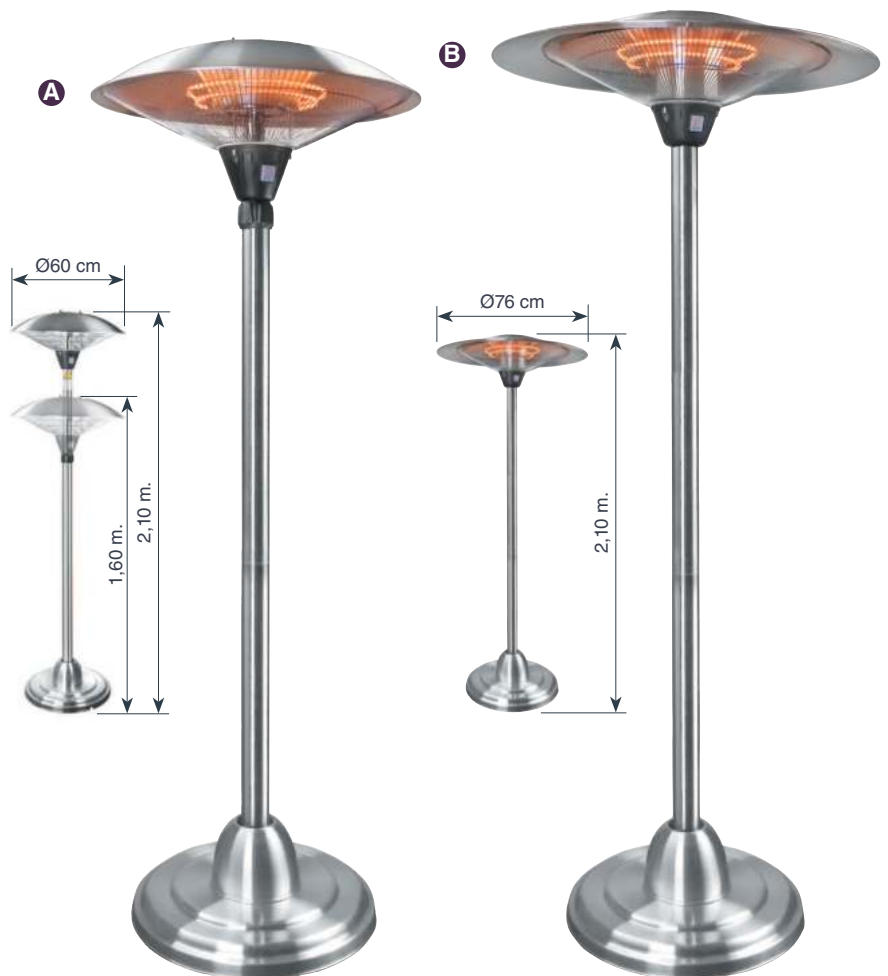

Ref	Tensión/Voltage	Potencia/Power	IP	Altura/Height	Cable/Cord	Calent./Heating	Dimensiones/Sizes	Peso/Weight
69410	220-240 V; 50/60 Hz	900/1200/2100 W	IP44	2,10 m	3,5 m	Lámpara calentamiento halógeno Halogen heating lamp	Ø58,5x1,6 - 2,10 m	13,35 Kg
69411	220-240 V; 50/60 Hz	1200/1800/3000 W	IP44	2,10 m	3,5 m		Ø76x2,10 m	14,40 Kg

# LÁMPARAS CALENTADORAS

Cadena de 1 m de longitud  
1 m long chain

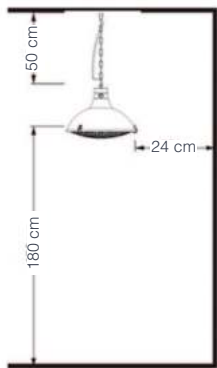

Rejilla protectora  
Protective grill

- Fácil de montar, incluye una cadena de 1 m de longitud para instalarla en el techo.
- Cuenta con un control remoto para encender y apagar la lámpara calentadora.
- Calor instantáneo, tiene 3 niveles de calentamiento (900 / 1200 / 2100 W).
- Seguro y respetuoso con el medio ambiente, no produce ni ruidos ni olores.

- Facile à monter, il inclut une chaîne de 1 m de longueur pour l'installer au plafond.
- Dispose d'une télécommande pour allumer et éteindre le chauffage.
- Chaleur instantanée, dispose de 3 niveaux de chauffe (900 / 1200 / 2100 W).
- Sûr et respectueux de l'environnement, ne produit ni bruit ni odeurs.

- Easy to assemble. Includes a 1m chain for ceiling installation.
- The lamp heater has a remote control to turn it on and off.
- Instant heat. It has 3 heating levels (900 / 1200 / 2100 W).
- Safe and environmentally friendly. Does not produce noise or odours.

**NOTA: Para instalar el calentador tenga en cuenta las distancias mínimas de seguridad que aparecen en la imagen**

NOTE: Be aware of the minimum safety distances shown in the image when installing the heater

Área de calentamiento · Heating area

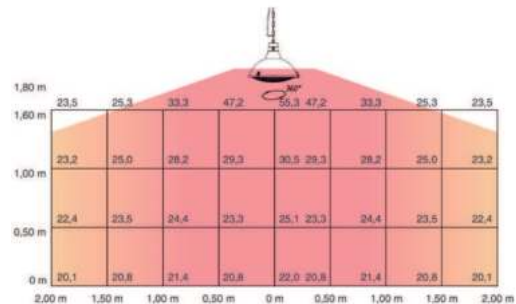

AL

Aluminium

## Lámpara calentadora de techo

Parasol chauffant électrique suspendu  
Elektrischer Deckenheizstrahler  
Electric hanging lamp heater  
Candeeiro aquecedor elétrico de teto

Ref	€	W	U.Venta
69422	209,80	2100	1

Ref	Tensión/Voltage	Potencia/Power	Lámparas Lamps	N. calentamiento Heating levels	Long. cadena Chain length	Nivel protección Protection level	Dimensiones Sizes	Peso/Weight
69422	220-240 V; 50/60 Hz	2100 W	2	3 (900/1200/2100W)	1,0 m	IP44	43x43x36 cm	3,15 Kg



Área de calentamiento · Heating area

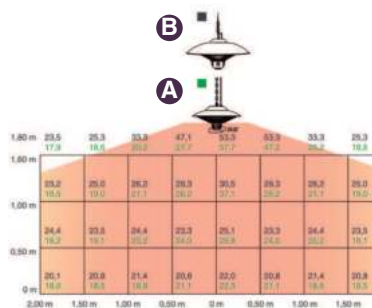

AL

Aluminium

## Lámpara calentador

Lampe chauffe  
Heizelement, freihängend  
Lamp  
Lâmpada aquecedora

Ref	€	W	U.Venta
A 69420	175,90	1500	1
B 69421	236,90	900/1200/1500	1

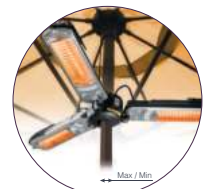

Max: Ø6 cm  
Min: Ø2,5 cm

Área de calentamiento · Heating area

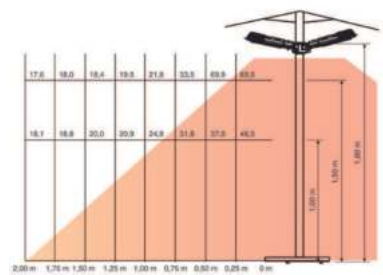

AL Fe

Aluminium Iron

## Calent. brazos abatibles

Lampe chauffege bras rabattables  
Heizgerät Arme ausklappbar  
Heating lamp arms fold-away  
Aquecedora braços abatíveis

Ref	€	W	U.Venta
69423	234,00	2000	1

Ref	Tensión/Voltage	Potencia/Power	IP	Calent./Heating	Dimensiones/Sizes	Peso/Weight
69420	220-240 V; 50/60 Hz	1500 W	IP24	Lámp. calentamiento Halógeno infrarrojos	Ø42,5x25 cm	2,40 Kg
69421	220-240 V; 50/60 Hz	900/1200/2100 W	IP24	Halogen infrared heating lamp	Ø58,5x35 cm	2,75 Kg
69423	220-240 V; 50/60 Hz	2000 W	IP34	Halogen infrared heating lamp	Ø100x8,5 cm	3,60 Kg

# CALENTADORES PARED

**Soporte extendido**  
Extended support



**Con control remoto**  
With remote control



**Área de calentamiento · Heating area**

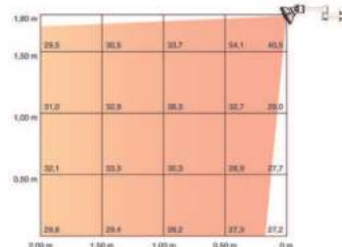

**AL**

Aluminium

## Calentador de pared

Chauffe de mur  
Heizung, Hängeleiste  
Wall lamp  
Aquecedora de parede

Ref	€	W	U.Venta
69424	304,70	1500	1

**Cuerpo de aleación de aluminio anodizado**  
Anodized aluminum alloy body.

**Calefactor de fibra de carbono de alta eficiencia**  
High Efficiency Carbon Fibre Heating



**Con control remoto**  
With remote control

**Incluye un soporte de pared con regulación angular**  
Includes a wall bracket with angular adjustment

**AL ABS**

Aluminium Plastic

## Calentador de pared

Chauffe de mur  
Heizung, Hängeleiste  
Wall lamp  
Aquecedora de parede

Ref	€	W	U.Venta
69425	201,30	1800	1
69426	236,30	2400	1

## Accesorios

Accessoires · Zubehör · Accessories · Acessórios



## Soporte para calentador

Support pour chauffe  
Heizungshalterung  
Support for lamp  
Suporte para aquecedora

Ref	€	Ø (cm)	h (cm)	U.Venta
69427	73,10	40	190	1



**Base con contrapeso**  
Counterbalanced base

Ref	Tensión/Voltage	Potencia/Power	Lámparas Lamps	N. calentamiento Heating levels	Ángulo de giro Angle of rotation	Nivel protección Protection level	Dimensiones Sizes	Peso/Weight
69424	220-240 V; 50/60 Hz	1500 W	1	1	25° (eje vertical/vertical axis)	IP55	75x13x13cm	3,60 Kg
69425	220-240 V; 50/60 Hz	1800 W	1	1	25° (eje vertical/vertical axis)	IP65	65x21,5x24,5 cm	2,40 Kg
69426	220-240 V; 50/60 Hz	2400 W	1	1	25° (eje vertical/vertical axis)	IP65	85x22,5x26,5 cm	3,00 Kg

# Colección CALENTADORES DE GAS



· Professional use ·

Solo para uso en exteriores · Only for outdoor use

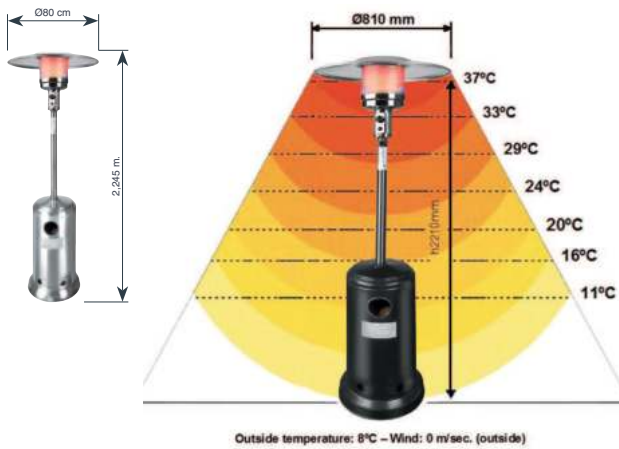

- Ideal para bares y restaurantes con mesas en el exterior.
- Indicado única y exclusivamente para exteriores.
- Disponible en dos acabados diferentes: acero inoxidable · negro.
- Malla protectora para evitar quemadura.

- Idéal pour les bars et les restaurants ayant des tables à l'extérieur.
- Destiné uniquement et exclusivement pour un usage en extérieur.
- Disponible en deux finitions différentes : acier inoxydable · noir.
- Maille de protection pour éviter les brûlures.

- Ideal für Bars und Restaurants mit Tischen im Freien.
- Nur für den Außenbereich geeignet.
- In zwei verschiedenen Ausführungen erhältlich: Edelstahl · Schwarz.
- Schutzgitter zum Vermeiden von Verbrennungen.

- Ideal for bars and restaurants with tables outside.
- Exclusively for outdoor use.
- Available in two different finishes: stainless steel · black.
- Protective mesh to prevent burns.

- Ideal para bares e restaurantes com mesas no exterior.
- Indicado única e exclusivamente para exteriores.
- Disponível em dois acabamentos diferentes, aço inoxidável e preto.
- Rede protectora para evitar queimaduras.

## Accesorios

Accessoires · Zubehör · Accessories · Acessórios



## Calentador terraza a gas

Chauffage de terrasse à gaz  
Gas-Terrassenheizstrahler  
Outdoor gas heater  
Aquecedor a gás para terraços

	Ref	€	U.Venta
A	69400	393,10	1
B	69401	297,40	1

PE  
Polyethylene

## Funda para calentador terraza a gas

Housse pour chauffage de terrasse à gaz  
Abdeckung für Gas-Terrassenheizstrahler  
Cover for outdoor gas heater  
Capa protectora para aquecedor a gás para terraços

Ref	€	U.Venta
R69400N	17,30	1



## Jgo. ruedas acero para calentador terraza

Ensemble de roves pour chauffage de terrasse à gaz  
Rollen für Gas-Terrassenheizstrahler  
Wheel set for outdoor gas heater  
Jogo de rodas para aquecedor a gás para terraços

	Ref	€	U.Venta
A	R69400B	11,10	1
B	R69400R	11,10	1

Ref	Potencia/Power	Posición piloto/Pilot posit.	Altura/Height	Peso/Weight
69400	14 KW (max)	870 g/h	2,245 m	20 Kg
69401	14 KW (max)	870 g/h	2,245 m	22 Kg

Funciona con gas propano o butano · Uses propane or butane gas only



**Índice**



**Sommaire**



**Index**



**Index**



**Índice**

Ref	Pag	Ref	Pag	Ref	Pag	Ref	Pag	Ref	Pag
10004	100	20045	28	20928	30	23626	76	25432	83, 109
10330	448	20046	28	20930	30	23628	76	25436	83, 109
10430	448	20050	28	20932	30	23629	77	R25436A	83, 104, 109
11330	448	20051	28	20934	30	23632	76	25440	83, 109
11430	448	20060	28	20936	30	23636	76	25534	96
14012	238	20061	28	20938	30	23637	77	25536	83
14013	241	20120	29	20940	30	23638	77	R25536A	83, 104
14016	146, 459	20124	29	20945	30	23640	76	25539	96
14019	146, 459	20128	29	20950	30	23641	77	25547	83
14025	146, 459	20130	29	20960	30	23724	110	R25547A	83, 104
14027	187	20132	29	21216	29	23728	110	R25736A	83, 104
14029	146, 459	20134	29	21220	29	23732	110	R25747A	83, 104
14033	146, 459	20136	29	21224	29	23736	110	25771	64, 224
14040	146, 459	20138	29	21228	29	23740	110	25772	64, 224
14042	187	20140	29	21524	75	23816	76	25773	64, 224
14046	146, 459	20145	29	21528	75	23818	76	25774	65, 225
14049	146, 459	20150	29	21618	75	23820	76	25775	65, 225
14050	187	20160	29	21620	75	23822	76	25776	65, 225
14065	241	20216	29	21622	75	23824	76	25777	65, 225
14100	187	20217	29	21624	75	23826	76	25781	64, 224
14114	147	20220	29	21626	75	23828	76	25782	64, 224
14119	147	20221	29	21628	75	23830	77	25783	64, 224
14121	281	20224	29	21632	75	23832	76	25816	51
14122	148	20225	29	21636	75	23836	76	25820	51
14124	147	20228	29	21640	75	23840	76	25823	51
14125	148	20229	29	21718	75	23900	81, 104	25824	51
14128	147	20470	30	21720	75	24114	82	25825	51
14130	148	20511	70	21722	75	24118	82	25827	51
14135	187	20515	70	21724	75	24120	82	25828	51
14136	187	20518	70	21726	75	24122	82	25829	51
14145	187	20522	70	21728	75	24123	83	25831	51
14212	50	20533	70	21732	75	24124	82	25832	51
14214	50	20540A	30, 96	21736	75	24125	83	25835	51
14216	50	20540F	30, 96	22718	75	24126	82	25840	66, 226
14218	50	20545A	30, 96	22720	75	24127	83	25841	66, 226
14220	50	20545F	30, 96	22722	75	24128	82	25842	66, 226
14318	50	20550A	30, 96	22724	75	24129	83	25843	67, 227
14320	50	20550F	30, 96	22726	75	24130	82	25845	67, 227
14322	50	20551	30	22728	75	24134	83	25846	67, 227
14324	50	20555A	30, 96	22732	75	24135	83	25847	67, 227
14420	50	20555F	30, 96	22736	75	24136	83	25848	66, 226
14422	50	20560A	30, 96	23322	77	24137	83	25849	66, 226
14424	50	20560F	30, 96	23323	80	24138	82	25850	66, 226
15720	97	20561	30	23326	77	24347	84	25851	66, 226
15725	97	20565A	30, 96	23327	80	24720	89	25852	66, 226
15730	97	20565F	30, 96	23330	77	24722	89	25853	67, 227
15735	97	20570A	30, 96	23416	75	24724	89	25855	67, 227
20020	28	20570F	30, 96	23418	75	24726	89	25856	67, 227
20021	28	20628	29, 110	23420	75	24728	89	25857	67, 227
20024	28	20630	29, 110	23422	75	24732	89	25858	66, 226
20025	28	20632	29, 110	23424	75	24918	91	25859	66, 226
20028	28	20634	29, 110	23426	75	24920	91	25871	64, 224
20029	28	20636	29, 110	23428	75	24922	91	25872	64, 224
20030	28	20638	29, 110	23432	75	24924	91	25873	64, 224
20031	28	20640	29, 110	23436	75	24926	91	25874	65, 225
20032	28	20645	29, 110	23540A	96	24928	91	25875	65, 225
20033	28	20650	29, 110	23550A	96	25144	87	25876	65, 225
20034	28	20660	29, 110	23612	77	25148	87	25877	65, 225
20035	28	20716	29	23614	77	25154	87	25881	64, 224
20036	28	20720	29	23616	76	25158	87	25882	64, 224
20037	28	20830	70	23618	76	25160	62, 222	25883	64, 224
20038	28	20840	70	23620	76	25161	62, 222	25909	60, 223
20039	28	20850	70	23622	76	25162	62, 222	25910	60, 223
20040	28	20920	30	23624	76	25163	62, 222	25911	60, 223
20041	28	20924	30	23625	77	25164	62, 222	25912	60, 223



Ref	Pag	Ref	Pag	Ref	Pag	Ref	Pag	Ref	Pag
25914	60, 223	27048	57	28061	323	28413	316	33410	368
25915	60, 223	27056	57	28062	323	28431	316	33411	368
25916	61	27058	57	28063	323	28432	316	33412	368
25917	61	27060	57	28081	325	28433	316	33413	368
R25917G	61, 104	27070	57	28082	325	28500	325	33414	368
25920	61	27074	57	28083	325	28501	325	33415	368
25921	61	27078	57	28101	324	28502	325	33416	368
R25921G	61, 104	27120	85	28102	324	28510	319	38010	356
25924	61	27122	85	28103	324	28511	319	38015	155, 335
25925	61	27124	85	28131	327	28512	319	39000	351
25927	61	27126	85	28132	327	28530	321	39001	351
25928	61	27128	85	28133	327	28531	321	39004	352
25929	61	27130	85	28141	322	28532	321	39008	357
25931	61	27132	85	28151	320	28540	323	39009	357
25932	61, 109	27320	59	28161	322	28550	325	39010	351
25933	61	27324	59	28172	320	28560	324	39012	621
R25933G	61, 104	27327	59	28175	317	32003	43	39014	350
25935	61	27328	59	28176	317	32016	42	39015	351
R25935G	61, 104	27416	59	28177	317	32020	42	39016	350
25936	61, 109	27418	59	28182	322	32024	42	39017	351
25940	61, 109	27420	53	28190	314	32028	42	39018	351
25950	61	27424	53	28191	314	32116	42	39020	350
25956	61	27428	53	28192	314	32120	42	39021	350
25958	61	27432	53	28195	314	32124	42	39023	350
26400	90	27436	53	28196	314	32125	42	39024	350
26418	91	27516	53	28197	314	32128	42	39025	350
26420	91	27520	53	28198	314	32129	42	39027	350
26422	91	R27520A	53, 104	28199	314	32214	42	39028	351
26424	91	27524	53	28200	314	32216	42	39029	351
26426	91	27528	53	28205	314	32218	42	39030	350
26428	91	R27528A	53, 104	28206	314	32220	42	39031	353
26430	91	27620	59, 86	28211	326	32318	43	39032	353
26718	91	27624	59, 86	28212	326	32324	43	39033	353
26720	91	27625	59, 86	28213	326	32420	43	39034	353
26722	91	27626	59, 86	28231	326	32424	43	39035	353
26724	91	27628	59, 86	28232	326	32624	43	39036	353
26726	91	27629	59, 86	28233	326	32628	43	39040	249
26728	91	27728	53	28271	326	32714	43	39041	249
26730	91	27732	53	28272	326	32716	43	39042	249
26816	88	R27732A	53, 104	28273	326	32916	43	R39042A	249
26818	88	27736	53	28311	323	32920	43	39043	130, 352
26820	88	27820	53, 86	28321	320	32924	43	39044	130, 352
26822	88	27824	53, 86	28331	317	32928	43	39047	130, 352
26824	88	27827	53, 86	28332	317	33101	368	39048	130, 352
26826	88	27828	53, 86	28333	317	33102	368	39060	352
26828	88	27832	53, 86	28341	316	33103	368	39061	352
26830	88	27920	59	28342	316	33104	368	39064	352
26832	88	27924	59	28343	316	33105	368	39065	358
26834	88	27928	59	28351	321	33106	368	39075	355
26838	88	28001	327	28352	321	33107	368	39108	357
26844	88	28002	327	28353	321	33108	368	39109	357
26848	88	28003	327	28371	318	33109	368	39110	350
26858	88	28011	324	28372	318	33121	213, 369, 390	39112	350
27018	57, 89	28012	324	28373	318	33124	369	39114	350
27020	57, 89	28013	324	28375	318	33125	369	39115	350
27022	57, 89	28021	318	28376	318	33126	369	39116	350
27024	57, 89	28022	318	28396	327	33401	368	39118	350
27026	57, 89	28023	318	28400	315	33402	368	39121	350
27028	57, 89	28031	319	28401	315	33403	368	39124	621
27030	57, 89	28032	319	28402	315	33404	368	39125	350
27032	57, 89	28033	319	28403	315	33405	368	39126	623
27034	57	28041	319	28404	315	33406	368	39127	623
27038	57	28051	321	28405	315	33407	368	39129	624
27040	57	28052	321	28411	316	33408	368	39133	624
27044	57	28053	321	28412	316	33409	368	39134	623

Ref	Pag	Ref	Pag	Ref	Pag	Ref	Pag	Ref	Pag
39135	622	40132	38	45624	33	50033	24	50228	25
R39135C	622	40133	38	45626	33	50033S	24	50229	25
39136	623	40136	38	45628	33	50036	23	50229N	25
39138	624	40140	38	45916	33	50036S	23	50300	147, 460
39139	624	40212	38	45918	33	50037	24	50301	449
39140	301, 618	40214	38	45920	33	50037S	24	50320	149
39160	301, 618	40216	38	45922	33	50040	23	50323	147, 460
39161	301, 618	40218	38	45924	33	50040S	23	50323S	147, 460
39162	301	40220	38	45926	33	50041	24	50324	149
39163	301	40318	39	45928	33	50041S	24	50327	147, 460
39164	300	40324	39	48016	55	50045	23	50327S	147, 460
39165	103, 349	40420	39	48020	55	50045S	23	50328	149
39166	300	40424	39	48024	55	50046	24	50332	148
39169	103, 349	40426	39	48028	55	50046S	24	50333	147, 460
39170	103, 349	40428	39	48116	55	50050	23	50333S	147, 460
39171	103, 349	40619	39, 93	48120	55	50050S	23	50334	149
39172	103, 349	40620	39	48124	55	50051	24	50336	148
39185	350	40621	39, 93	48128	55	50051S	24	50337	147, 460
39208	355	40622	39	48214	55	50060	23	50337S	147, 460
39210	355	40623	39, 93	48216	55	50060S	23	50338	149
39212	355	40624	39	48218	55	50061	24	50340	148
39213	355	40625	39, 93	48220	55	50061S	24	50341	147, 460
39215	355	40626	39	48624	55	50116	24	50341S	147, 460
39218	355	40627	39, 93	48628	55	50116S	24	50428	23, 151
39266	358	40628	39	48720	55, 90	50119	24	50432	23, 151
39402	309, 309	40629	39, 93	48724	55, 90	50119S	24	50438	148
39403	309	40632	39	48728	55, 90	50120	24	50440	151
39404	309	40636	39	48916	55	50120S	24	50445	151
39405	310	40640	39	48920	55	50123	24	50450	148
39406	310	40712	39	48924	55	50123S	24	50460	151
39407	310	40714	39	48928	55	50124	24	50540	25, 95
39410	310	40716	39	49014	354	50124S	24	50541	148
39411	310	40718	39	49016	354	50127	24	50550	25, 95
39413	309	40916	39	49017	354	50127S	24	50551	148
39414	309	40918	39	49021	354	50128	24	50560	25, 95
39415	310	40920	39	49024	354	50128S	24	50561	148
39420	310	40922	39	49025	354	50131	24	50570	25, 95
39423	309	40924	39	49027	354	50131S	24	50624	24, 107
39424	309	40926	39	49030	354	50132	24	50624S	24, 107
39430	310	40928	39	49110	354	50132S	24	50624W	107
39433	309	40932	39	49112	354	50135	24	50625	25
39434	309	40936	39	49116	354	50135S	24	50628	24, 107
39441	302	40940	39	49121	354	50136	24	50628S	24, 107
39445	302	45016	32	49185	354	50136S	24	50628W	107
39450	302	45018	32	49210	354	50139	24	50629	25
40016	38	45020	32	49212	354	50139S	24	50632	24, 107
40018	38	45022	32	49216	354	50140	24	50632S	24, 107
40020	38	45024	32	50016	23	50140S	24	50632W	107
40022	38	45026	32	50016S	23	50145	24	50633	25
40024	38	45116	32	50017	24	50145S	24	50636	24, 107
40026	38	45118	32	50017S	24	50150	24	50636S	24, 107
40028	38	45120	32	50020	23	50150S	24	50636W	107
40032	38	45122	32	50020S	23	50160	24	50637	25
40036	38	45124	32	50021	24	50160S	24	50640	24, 107
40040	38	45126	32	50021S	24	50212	25	50640S	24, 107
40116	38	45214	33	50024	23	50214	25	50640W	107
40118	38	45216	33	50024S	23	50216	25	50645	24, 107
40120	38	45218	33	50025	24	50217	25	50645S	24, 107
40121	38	45220	33	50025S	24	50218	25	50645W	107
40122	38	45320	33, 93	50028	23	50219	25	50650	24, 107
40124	38	45324	33, 93	50028S	23	50220	25	50650S	24, 107
40125	38	45328	33, 93	50029	24	50221	25	50650W	107
40126	38	45420	33, 93	50029S	24	50224	25	50660	24, 107
40128	38	45424	33, 93	50032	23	50225	25	50660S	24, 107
40129	38	45428	33, 93	50032S	23	50225N	25	50660W	107

Ref	Pag	Ref	Pag	Ref	Pag	Ref	Pag	Ref	Pag
50717	25	53720	49, 92	54139	21	55418	431	55483	431
50721	25	53721	49, 92	54139S	21	55419	431	55484	431
50815	69	53724	49, 92	54140	21	55420	431	55485	431
50816	69	53725	49, 92	54140S	21	55421	431	55486	431
50818	69	53728	49, 92	54145	21	55422	431	55487	431
50819	69	53729	49, 92	54145S	21	55423	431	55488	431
50823	69	53828	49, 92	54150	21	55424	431	55489	431
50824	69	53829	49, 92	54150S	21	55425	431	55490	431
50828	147, 460	53836	396, 547	54212	21	55426	431	55491	431
50829	148	53916	49	54214	21	55427	431	55492	431
50832	147, 460	53918	49	54216	21	55428	431	55493	431
50833	148	53920	49	54217	21	55429	431	55494	431
50836	147, 460	53924	49	54218	21	55430	431	55495	431
50837	148	54020	20	54219	21	55431	431	55496	431
50840	147, 460	54020S	20	54220	21	55432	431	55497	431
50841	148	54021	20	54221	21	55433	431	55498	431
50845	147, 460	54021S	20	54224	21	55434	431	55499	431
50846	148	54024	20	54225	21	55435	431	55500	431
50850	147, 460	54024S	20	54225N	22	55436	431	55501	431
50851	148	54025	20	54228	21	55437	431	55502	431
50916	25	54025S	20	54229	21	55438	431	55503	431
50918	25	54028	20	54229N	22	55439	431	55504	431
50920	25	54028S	20	54621	22	55440	431	55505	431
50924	25	54029	20	54625	22	55441	431	55506	431
50928	25	54029S	20	54629	22	55442	431	55507	431
50932	25	54032	20	54633	22	55443	431	55508	431
50933	69	54032S	20	54636	21, 107	55444	431	55509	431
50934	69	54033	20	54636S	21, 107	55445	431	55510	431
50936	25	54033S	20	54637	22	55446	431	55511	431
50940	25	54036	20	54640	21, 107	55447	431	55512	431
50945	25	54036S	20	54640S	21, 107	55448	431	55513	431
50950	25	54037	20	54645	21, 107	55449	431	55514	431
50960	25	54037S	20	54645S	21, 107	55450	431	55515	431
51216	25	54040	20	54650	21, 107	55451	431	55516	431
51218	25	54040S	20	54650S	21, 107	55452	431	55517	431
51220	25	54041	20	54916	22	55453	431	55518	431
51222	25	54041S	20	54920	22	55454	431	55519	431
51224	25	54045	20	54924	22	55455	431	55520	432
51620	74	54045S	20	54928	22	55456	431	55521	432
51621	74	54046	20	54932	22, 69	55457	431	55522	432
51624	74	54046S	20	54936	22	55458	431	55523	432
51625	74	54050	20	54940	22	55459	431	55524	432
51628	74	54050S	20	54945	22	55460	431	55525	432
51629	74	54051	20	54950	22	55461	431	55526	432
51632	74	54051S	20	55216	22	55462	431	55527	432
51633	74	54119	21	55220	22	55463	431	55528	432
51636	74	54119S	21	55224	22	55464	431	55529	432
51637	74	54120	21	55400	430	55465	431	55530	432
51640	74	54120S	21	55401	430	55466	431	55531	432
51641	74	54123	21	55402	430	55467	431	55532	432
51720	74	54123S	21	55403	430	55468	431	55533	432
51724	74	54124	21	55404	430	55469	431	55534	432
51728	74	54124S	21	55405	430	55470	431	55535	432
51732	74	54127	21	55406	430	55471	431	55536	432
51736	74	54127S	21	55407	430	55472	431	55537	432
51740	74	54128	21	55408	430	55473	431	55538	432
53016	48	54128S	21	55409	431	55474	431	55539	432
53018	48	54131	21	55410	431	55475	431	55540	432
53020	48	54131S	21	55411	431	55476	431	55541	432
53024	48	54132	21	55412	431	55477	431	55542	432
53214	48	54132S	21	55413	431	55478	431	55543	432
53216	48	54135	21	55414	431	55479	431	55544	432
53218	48	54135S	21	55415	431	55480	431	55545	432
53220	48	54136	21	55416	431	55481	431	55546	432
53625	49	54136S	21	55417	431	55482	431	55547	432

Ref	Pag	Ref	Pag	Ref	Pag	Ref	Pag	Ref	Pag
55548	432	55613	432	55678	435	55758	433	55823	434
55549	432	55614	432	55679	435	55759	433	55824	434
55550	432	55615	432	55680	435	55760	433	55825	434
55551	432	55616	432	55681	435	55761	433	55826	434
55552	432	55617	432	55682	435	55762	433	55827	434
55553	432	55618	432	55683	435	55763	433	55828	434
55554	432	55619	432	55684	435	55764	433	55829	434
55555	432	55620	432	55700	430	55765	433	55830	434
55556	432	55621	432	55701	430	55766	433	55831	434
55557	432	55622	432	55702	430	55767	433	55832	434
55558	432	55623	432	55703	430	55768	433	55833	434
55559	432	55624	432	55704	430	55769	433	55834	434
55560	432	55625	432	55705	430	55770	433	55835	434
55561	432	55626	432	55706	430	55771	433	55836	434
55562	432	55627	432	55707	430	55772	433	55837	434
55563	432	55628	432	55708	430	55773	433	55838	434
55564	432	55629	432	55709	433	55774	433	55839	434
55565	432	55630	432	55710	433	55775	433	55840	434
55566	432	55631	435	55711	433	55776	433	55841	434
55567	432	55632	435	55712	433	55777	433	55842	434
55568	432	55633	435	55713	433	55778	433	55843	434
55569	432	55634	435	55714	433	55779	433	55844	434
55570	432	55635	435	55715	433	55780	433	55845	434
55571	432	55636	435	55716	433	55781	433	55846	434
55572	432	55637	435	55717	433	55782	433	55847	434
55573	432	55638	435	55718	433	55783	433	55848	434
55574	432	55639	435	55719	433	55784	433	55849	434
55575	432	55640	435	55720	433	55785	433	55850	434
55576	432	55641	435	55721	433	55786	433	55851	434
55577	432	55642	435	55722	433	55787	433	55852	434
55578	432	55643	435	55723	433	55788	433	55853	434
55579	432	55644	435	55724	433	55789	433	55854	434
55580	432	55645	435	55725	433	55790	433	55855	434
55581	432	55646	435	55726	433	55791	433	55856	434
55582	432	55647	435	55727	433	55792	433	55857	434
55583	432	55648	435	55728	433	55793	433	55858	434
55584	432	55649	435	55729	433	55794	433	55859	434
55585	432	55650	435	55730	433	55795	433	55860	434
55586	432	55651	435	55731	433	55796	433	55861	434
55587	432	55652	435	55732	433	55797	433	55862	434
55588	432	55653	435	55733	433	55798	433	55863	434
55589	432	55654	435	55734	433	55799	433	55864	434
55590	432	55655	435	55735	433	55800	433	55865	434
55591	432	55656	435	55736	433	55801	433	55866	434
55592	432	55657	435	55737	433	55802	433	55867	434
55593	432	55658	435	55738	433	55803	433	55868	434
55594	432	55659	435	55739	433	55804	433	55869	434
55595	432	55660	435	55740	433	55805	433	55870	434
55596	432	55661	435	55741	433	55806	433	55871	434
55597	432	55662	435	55742	433	55807	433	55872	434
55598	432	55663	435	55743	433	55808	433	55873	434
55599	432	55664	435	55744	433	55809	433	55874	434
55600	432	55665	435	55745	433	55810	433	55875	434
55601	432	55666	435	55746	433	55811	433	55876	434
55602	432	55667	435	55747	433	55812	433	55877	434
55603	432	55668	435	55748	433	55813	433	55878	434
55604	432	55669	435	55749	433	55814	433	55879	434
55605	432	55670	435	55750	433	55815	433	55880	434
55606	432	55671	435	55751	433	55816	433	55881	434
55607	432	55672	435	55752	433	55817	433	55882	434
55608	432	55673	435	55753	433	55818	433	55883	434
55609	432	55674	435	55754	433	55819	433	55884	434
55610	432	55675	435	55755	433	55820	434	55885	434
55611	432	55676	435	55756	433	55821	434	55886	434
55612	432	55677	435	55757	433	55822	434	55887	434

Ref	Pag	Ref	Pag	Ref	Pag	Ref	Pag	Ref	Pag
55888	434	55953	436	56522	428	57924	27	60138	108
55889	434	55954	436	56523	428	57928	27	60139	111
55890	434	55955	436	56524	429	57932	27	60141	111
55891	434	55956	436	56525	429	57936	27	60142	108
55892	434	55957	436	56526	429	57940	27	60144	111
55893	434	55958	436	56527	429	58050	260	60146	108
55894	434	55959	436	57007	428	58150	260	60149	111
55895	434	55960	436	57008	428	58151	260	60150	108
55896	434	55961	436	57009	428	58152	260	60151	111
55897	434	55962	436	57010	428	58250	260	60155	108
55898	434	55963	436	57011	428	58251	260	60159	111
55899	434	55964	436	57012	428	58252	260	60160	108
55900	434	55965	436	57013	428	60000	339	60161	111
55901	434	55966	436	57014	428	60001	356	60170	63, 111, 231
55902	434	55967	436	57015	428	60002	114	60172	63, 111, 231
55903	434	55968	436	57016	26	60003	114	60175	63, 111, 231
55904	434	55969	436	57017	26	60004	339	60180	63, 111, 231
55905	434	55970	436	57020	26	60005	339	60182	111
55906	434	55971	436	57021	26	60007	495	60184	111
55907	434	55972	436	57024	26	60008	495	60186	111
55908	434	55973	436	57025	26	60009	339	60188	111
55909	434	55974	436	57028	26	60010	102	60190	63, 231
55910	434	55975	436	57029	26	60011	102	60192	63, 231
55911	434	55976	436	57032	26	60013	147, 460	60196	63, 231
55912	434	55977	436	57033	26	60014	104	60228	108
55913	434	55978	436	57036	26	60016	147, 460	60232	108
55914	434	55979	436	57037	26	60018	356	60236	108
55915	434	55980	436	57040	26	60020	147, 460	60240	108
55916	434	55981	436	57041	26	60021	156	60251	163
55917	434	55982	436	57116	27	60022	356	60253	163
55918	434	55983	436	57120	27	60023	356	60255	163
55919	434	55984	436	57124	27	60024	147, 460	60257	163
55920	434	56007	428	57128	27	60026	156	60258	159
55921	434	56008	428	57132	27	60027	156	R60258A	159
55922	434	56009	428	57136	27	60028	147, 460	60259	159
55923	434	56010	428	57140	27	60030	156	R60259A	159
55924	434	56011	428	57212	27	60031	156	60260	250
55925	434	56012	428	57214	27	60032	147, 460	60261	250
55926	434	56013	428	57216	27	60036	147, 460	60262	250
55927	434	56014	428	57217	27	60037	100	60263	250
55928	434	56015	428	57218	27	60038	100	60264	250
55929	434	56212	422	57219	27	60039	100	60265	250
55930	434	56216	422	57220	27	60040	147, 460	60266	250
55931	436	56302	428	57221	27	60041	102	60267	250
55932	436	56317	428	57224	27	60044	100	60299	152, 337
55933	436	56320	428	57225	27	60045	100	60300	149
55934	436	56321	429	57302	428	60046	100	60301	342
55935	436	56322	429	57317	428	60048	156	60302	342
55936	436	56325	429	57320	428	60050	146, 459	60303	342
55937	436	56330	428	57321	429	60051	146, 459	60305	341
55938	436	56412	422	57322	429	60054	145, 458	60306	114
55939	436	56416	422	57325	429	60055	145, 458	60307	341
55940	436	56435	429	57330	428	60059	356	60308	114
55941	436	56502	429	57435	429	60061	356	60309	114
55942	436	56507	429	57624	27, 107	60066	356	60310	114
55943	436	56508	429	57625	27	60070	101	60311	149
55944	436	56509	429	57628	27, 107	60072	364	60312	114
55945	436	56510	429	57629	27	60080	100	60313	149
55946	436	56511	429	57632	27, 107	60081	100	60314	114
55947	436	56512	429	57636	27, 107	60082	100	60315	149
55948	436	56513	429	57640	27, 107	60127	111	60316	114
55949	436	56514	429	57717	27	60130	108	60316P	150
55950	436	56515	429	57721	27	60131	111	60316V	150
55951	436	56517	429	57916	27	60134	108	60317	149
55952	436	56520	429	57920	27	60135	111	60318	149

Ref	Pag	Ref	Pag	Ref	Pag	Ref	Pag	Ref	Pag
60318P	150	60409	115	60497	162	60612	139, 463	61060	231
60319	150	60410	114	60498	162	60700	130	61063	231
60319V	150	60411	115	60499	152, 337	60701	449	61064	189
60320	149	60412	114	60500	365	60702	449	61065	231
60320P	150	60413	115	60501	366	60704	448	61066	231
60321	150	60414	114	60502	366	60710	130	61069	230
60322	149	60415	115	60503	366	60726	132	61070	189
60322P	150	60416	114	60507	114	60731	130	61071	189
60323	150	60417	115	60508	114	60740	130	61072	189
60324	149	60419	115	60509	114	60746	130	61073	189
60324P	150	60420	133	60510	346	60760	130	61095	240
60325	150	60421	133	60511	347	60761	130	61096	240
60326	149	60422	133	60512	158	60776	130	61097	240
60327	293	60423	115	60513	346	60791	130	61098	240
60329	154, 334	60424	134	60514	158	60802	105, 183	61101	103, 349
60331	345	60425	133	60516	158	60803	105, 183	61102	103, 349
60332	345	60426	132	60517	158	60804	105, 183	61103	103, 349
60334	154, 334	60427	115	60518	158	60805	105, 183	61107	231
60335	343	60429	134, 340	60520	115	60812	238	61109	231
60336	340	60430	132	60521	366	60814	238	61110	188
60340	155, 335	60431	157	60522	366	60818	238	61112	231
60343	347	60432	157	60523	362	60823	238	61113	188
60344	153, 338	60434	132	60524	336	60825	238	61116	188
60346	332	60435	133	60527	336	60829	238	61121	188
60347	332	60438	133	60528	336	60922	238	61122	188
60348	151	60442	133	60529	336	60924	238	61126	220, 389
60349	151	60443	133	60547	332	60928	238	61127	220, 389
60350	339	60444	332	60555	365	61001	240, 449	61128	220, 389
60351	332	60445	133	60562	129	61002	240, 449	61129	215
60352	332	60446	133	60569	367	61004	240	61130	215
60353	332	60455	367	60570	366	61007	230	61131	215
60354	332	60456	367	60571	366	61008	240	61132	215
60356	345	60457	367	60572	366	61009	230	61133	161
60357	345	60458	367	60573	366	61010	189	61134	161
60359	359, 620	60459	366	60574	366	61012	240	61135	161
60361	155, 335	60460	344	60575	367	61015	189	61136	161
60365	339	60461	133	60576	366	61016	189	61137	220, 389
60366	330	60462	133	60577	366	61019	189	61138	220, 389
60367	330	60463	133	60578	348	61021	189	61139	220, 389
60368	330	60464	133	60580	360	61023	240	61140	220, 389
60369	330	60465	133	60581	360	61024	101	61141	289
60372	330	60467	133	60582	360	61025	241	61150	230
60377	330	60468	133	60583	361	61029	189	61151	230
60378	330	60469	133	60584	361	61030	101	61152	230
60380	330	60470	366	60585	361	61031	189	61153	231
60386	352	60471	366	60586	361	61033	101	61154	231
60387	157	60472	366	60587	361	61034	101	61155	231
60388	333	60473	366	60588	361	61036	101	61162	230
60389	333	60474	366	60589	361	61041	189	61167	230
60390	162	60475	366	60590	361	61042	232	61200	163
60391	162	60476	366	60591	363	61043	189	61201	163
60392	333	60477	366	60592	363	61044	189	61308	114
60393	333	60478	366	60593	367	61045	232	61310	114
60394	156, 340	60479	366	60594	363	61046	232	61312	114
60397	339	60480	366	R60594A	363	61047	232	61316	115
60398	330	60481	366	60595	363	61048	232	61318	115
60399	330	60482	133	60599	152, 337	61049	232	61319	281
60401	158	60483	133	60600	366	61051	189	61320	115
60402	150	60484	133	60601	366	61052	230	61321	281
60403	158	60485	363	60602	366	61053	231	61323	115
60404	134	60487	362	60603	366	61055	231	61326	115
60405	367	60488	363	60604	366	61056	231	61330	115
60406	367	60491	362	60605	366	61057	231	61331	279
60407	367	60492	363	60606	366	61058	231	61335	115
60408	114	60495	362	60610	139, 463	61059	231	61341	343

Ref	Pag	Ref	Pag	Ref	Pag	Ref	Pag	Ref	Pag
61342	343	61631	138, 462	61816	172	62036	257	62302	295
61343	343	61634	139, 462	61817	172	62046	258	62303I	292
61344	343	61635	138, 462	61820	186	62048	258	62304I	292
61346	343	61636	138, 462	61821	220, 389	62051	257	62306	245, 293
61347	343	61639	139, 462	61823	220, 389	62054	257	62307	244
61348	343	61640	138, 462	61825	186	62056	257	62315	280
61349	343	61641	138, 462	61828	187	62060	261	62317	245, 482
61351	340	61644	139, 462	61830	186	62071	256	62318	244
61352	340	61645	138, 462	61831	186	62074	256	62320	280
61353	333	61646	138, 462	61832	187	62076	256	62321	281
61354	341	61649	139, 462	61835	186	62081	256	62322	280
61355	333	61650	138, 462	61836	186	62084	256	62325	277
61356	341	61651	138, 462	61838	187	62086	256	62326	294
61359	153, 338	61655	138, 462	61840	186	62096	258	62329	294
61360	343	61660	138, 462	61841	187	62099	258	62330	294
61361	248	61668	526	61843	187	62110	261	62334	245
61362	166	R61668C	526	61845	186	62115	261	62336	281
61363	341	R61668D	526	61848	187	62120	261	62337	245, 293
61364	341	61669	526	61850	186	62121	257	62338	280
61365	341	61671	522	61860	186	62124	257	62341	294
61400	165	R61671A	522	61870	187	62126	257	62344	348
61403	165	61672	521	61871	186	62135	261	62346	281
61404	165	R61672D	521	61880	186	62153	259	62352	295
61405	165	61673	521	61881	186	62160	261	62353	244
61407	480	61674	521	61903	235	62163	259	62354	279
61408	166	61675	521	61904	235	62168	259	62355	277
61409	238	61678	523	61905	235	62173	259	62356	280
61410	114	R61678K	523	61906	235	62176	259	62359	348
61411	114	R61678L	523	61907	235	62180	259	62362	279
61412	114	61679	525	61908	234	62181	290	62363	293
61413	114	R61679AA	525	61909	235	62182	290	62364	279
61414	99	R61679AB	525	61912	167	62183	259	62365	279
61415	238	61681	522	61921	234	62186	259	62366	279
61416	166	61682	524	61925	167	62210	261	62367	279
61418	166	R61682A	524	61925A	167	62215	261	62368	279
61420	164	R61682B	524	61925R	167	62216	261	62371	279
61421	134	61683	524	61940	167	62220	261	62373	279
61422	165	61700	176, 619	61940A	167	62225	261	62380	239
61424	238	61702	180	61940R	167	62235	261	62388	292
61425	164	61703	177	61950	275	62252	234	62389	280
61430	238	61705	180	61951	284	62260	261	62391	285
61460	134	61707	177	61952	284	62261	288	62392	285
61461	134	61708	178	61953	284	62262	288	62393	285
61481	134	61709	180	61954	285, 383	62263	288	62394	238
61524	139, 462	61710	180	61955	285	62264	288	62399	244
61529	139, 462	61711	180	61956	285	62265	288	62404	240
61530	95	61712	178	61965	275	62266	288	62406	287
61534	139, 462	61714	180	61970	167	62267	289	62410	270
61535	95	61715	180	61970A	167	62268	289	62414	292
61540	95	61716	176, 619	61970R	167	62269	289	62415	270
61545	95	61717	177	61974	167, 480	62270	277	62424	238
61550	95	61720	178	61977	167, 480	62271	281	62430	270
61608	141	61721	179	61978	167, 480	62272	281	62435	130
61610	234	61722	179	61979	167, 480	62273	281	62436	281
61615	138, 462	61725	178	61980	167, 480	62276	277	62438	292
61620	138, 462	61730	176, 619	62001	261	62277	277	62439	281
61621	138, 462	61740	179	62003	261	62278	294	62440	272
61622	138, 462	61742	179	62004	364	62279	294	62441	271
61623	138, 462	61802	239, 390	62010	261	62280	383	62442	271
61624	139, 462	61806	239, 390	62022	258	62281	383	62443	271
61625	138, 462	61809	239, 390	62023	261	62283	383	62444	271
61626	138, 462	61811	173	62026	257, 258	62286	292	62445	130
61627	138, 463	61812	173	62029	258	62288	277	62446	130
61629	139, 462	61813	172	62031	257	62289	449	62448	272
61630	138, 462	61815	172	62035	261	62300	278	62450	181

Ref	Pag	Ref	Pag	Ref	Pag	Ref	Pag	Ref	Pag
62452	181	62545	384	62686	331	62862	234	62989	98, 248, 413
62453	181	62545A	95	62687	331	62863	247	62998	98, 248, 413
62454	181	62546	274	62688	331	62864	234	63005	358
62456	182	62547	274	62689	331, 358	62865	247	63008	215
62457	182	62548	274	62690	150	62866	234	63010	297
62458	181	62551	234	62691	150	62867	234	63012	297
62459	181	62555	234	62692	150	62868	216	63013	297
62460	270	62556	275	62697	150	62869	216	63015	358
62461	233	62559	275	62698	150	62872	247	63016	248
62462	233	62563	269	62702	285	62873	247	63017	248
62463	233	62564	269	62715	285	62874	247	63018	297
62464	233	62575	269	62716	285	62875	247	63019	299
62465	233	62576	271	62720	285	62892	157	63021	299
62466	233	62577	271	62721	285	62898	239	63022	299
62470	233	62578	271	62725	285	62899	239	63028	297
62472	271, 382	62579	269	62726	285	62901	139, 463	63031	296, 609
62473	271, 382	62584	274	62740	144, 456	62902	157	63033	298
62475	271, 382	62585	274	62741	142, 454	62903	235	R63033	298
62478	278	62586	274	62742	142, 454	62904	235	63036	215
62479	278	62587	274	62745	142, 454	62905	235	63038	331, 358
62480	272	62588	274	62750	142, 454	62906	235	63041	214
62481	270	62589	274	62751	198	62908	248	63042	214
62483	270	62596	385	62753	198	62912	160	63043	215
62484	270	62597	385	62754	198	62924	246	63044	297
62485	270	62598	269	62755	198	62926	246	63046	297
62486	270	62599	269	62756	198	62928	249	63047	297
62487	181	62600	481	62757	198	62929	246	63048	299
62491	269	62601	118	62759	198	62930	246	63051	298
62492	269	62603	118	62761	198	62931	247	R63051A	298
62495	181	62604	118	62762	198	62933	247	63052	295
62496	269	62605	118	62764	198	62938	249	63054	296, 609
62498	182	62606	118	62766	198	62939	246	63055	299
62500	129, 182	62607	118	62768	198	62940	246	63056	296, 609
62503	119	62608	118	62769	198	62941	241	63057	296, 609
62504	119	62609	118	62770	198	62942	162	63058	298
62505	119	62610	150	62771	198	62943	162	63060	246
62506	119	62611	150	62772	198	62944	216, 387	63061	246
62507	119	62612	150	62780	199	62946	160	63062	246
62512	151	62613	150	62781	199	62951	239	63063	246
62513	151	62614	150	62782	199	62952	160	63064	246
62515	151	62615	150	62783	199	62954	247	63065	246
62516	151	62616	150	62784	199	62955	247	63070	246
62517	151	62617	150	62785	199	62956	247	63071	246
62519	180, 457	62618	150	62786	199	62957	115	63072	246
62521	151	62619	150	62787	199	62958	151	63073	246
62522	270	62620	150	62791	198	62959	115	63074	246
62523	270	62621	150	62792	198	62962	130	63075	246
62524	151	62623	150	62793	198	62963	130	63115	110
62525	234	62626	291	62811	118	62964	421	63130	110
62528	129, 182	62627	291	62814	236	62970	238	63131	591
62530	95	62628	291	62816	236	62971	238	63132	591
62530A	95	62630	118	62817	236, 252	62972	115	63133	591
62531	151	62633	144, 456	62818	236	62973	248	63137	299
62532	183	62635	272	62819	154, 334	62974	248	63138	273
62533	183	62636	272	62820	186	62976	248	63139	273
62534	275	62673	331	62821	247	62978	244	63141	286
62535	95	62675	331	62823	236	62980	154, 334	63142	286
62535A	95	62676	331	62824	237	62981	244	63143	286
62536	274	62677	132	62825	186	62982	244	63144	287
62537	274	62678	141	62830	186	62983	245	63145	287
62538	274	62679	141	62835	186	62984	245	63146	287
62540	95	62680	150	62840	186	62985	245	63147	287
62540A	95	62683	331	62841	187	62986	244	63148	287
62541	384	62684	248, 331	62845	186	62987	148	63149	287
62542	384	62685	331	62850	186	62988	114	63161	202



Ref	Pag	Ref	Pag	Ref	Pag	Ref	Pag	Ref	Pag
63162	202	63342	450	63491	213, 369, 390	63629	110	63853	193
63163	202	63350	200, 287	63492	219, 388	63631	110	63854	193
63164	202	63351	200, 287	63494	219, 388	63632	78	63855	192
63165	202	63355	447	63514	115	63633	110	63856	193
63166	202	63360	270	63516	115	63635	110	63857	193
63169	202	63361	200	63518	115	63636	78	63858	193
63171	202	63362	200	63520	115	63637	110	63859	193
63172	202	63363	200	63524	115	63639	110	63860	193
63173	202	63364	200	63528	115	63640	78	63861	193
63174	202	63365	200	63531	196	63641	110	63862	193
63175	202	63367	200	63532	196	63642	80	63863	192
63176	202	63368	200	63533	196	63643	110	63864	193
63177	202	63369	200	63534	196	63644	80	63865	192
63178	202	63370	201	63535	196	63647	110	63871	218, 387
63180	203	63372	201	63536	196	63651	110	63872	218, 387
63181	203	63373	201	63541	196	63656	110	63873	218, 387
63182	203	63374	201	63542	196	63661	110	63874	218, 387
63183	203	63375	201	63543	196	63666	110	63880	218, 387
63184	203	63379	201	63544	196	63671	110	63881	218, 387
63185	203	63380	201	63545	196	63681	110	63882	218, 387
63186	203	63381	204, 228	63546	196	63691	110	63890	219, 388
63187	203	63382	204, 228	63551	197	63700	111	63893	219, 388
63188	203	63383	204, 228	63552	197	63712	79	63894	219, 388
63189	203	63384	204, 228	63553	198	63714	79	63911	343
63190	203	63385	204, 228	63554	198	63720	78	63912	160
63191	203	63386	204, 228	63555	198	63724	78	63913	161
63192	203	63387	204, 228	63556	198	63725	79	63914	161
63215	236	63388	204, 228	63557	197	63726	78	63915	161
63220	236	63389	204, 228	63558	197	63727	79	63926	246
63225	236	63390	205, 229	63567	197	63728	78	63928	79, 110
63232	80	63391	205, 229	63568	197	63729	80	63929	246
63233	80	63392	205, 229	63570	198	63731	111	63932	79, 110
63261	200	63393	205, 229	63571	198	63732	78	63936	79, 110
63262	200	63394	205, 229	63572	198	63733	80	63939	246
63263	200	63395	205, 229	63573	197	63736	78	63940	79, 110
63264	200	63396	205, 229	63577	197	63740	78	63941	194
63265	200	63397	205, 229	63580	198	63741	111	63942	194
63267	200	63398	205, 229	63581	198	63751	111	63943	194
63268	200	63399	205, 229	63582	198	63761	111	63944	194
63269	200	63400	205, 229	63585	198	63771	111	63945	194
63270	201	63401	205, 229	63586	197, 482	63828	80	63946	195
63272	201	63419	79	63589	196	63829	80	63947	195
63273	201	63423	79	63599	196	63830	192	63948	195
63274	201	63424	79	63600	199	63831	192	63949	195
63275	201	63428	79	63601	199	63832	192	63950	195
63279	201	63432	79	63602	199	63833	192	63951	195
63280	201	63471	218, 387	63603	199	63834	192	63952	195
63302	241, 446	63472	218, 387	63604	199	63835	193	63953	195
63303	446	63473	218, 387	63605	199	63836	193	63954	195
63304	240	63474	218, 387	63609	197	63837	193	63955	195
63305	446	63476	217, 386	63610	197	63838	193	63956	195
63306	447	63477	217, 386	63611	198	63839	193	63957	195
63307	447	63478	217, 386	63612	198	63840	193	63958	195
63309	447	63479	217, 386	63613	79	63841	193	63959	195
63310	270	63480	218, 387	63614	79	63842	193	63960	195
63312	446	63481	218, 387	63617	197	63843	193	63961	195
63315	270	63482	218, 387	63619	197	63844	193	63962	195
63319	446	63483	278	63620	78	63845	193	63963	195
63320	270	63484	213, 369, 390	63621	110	63846	193	63964	195
63331	450	63485	213, 369, 390	63623	110	63847	193	63965	195
R63331A	450	63486	217, 386	63624	78	63848	193	63966	194
63332	450	63487	217, 386	63625	110	63849	193	63967	195
R63332A	450	63488	217, 386	63626	78	63850	193	63968	195
63335	447	63489	217, 386	63627	110	63851	193	63969	195
63341	450	63490	219, 388	63628	78	63852	193	63970	195

Ref	Pag	Ref	Pag	Ref	Pag	Ref	Pag	Ref	Pag
63971	195	65215	261	66165J	206, 416	66355	412	66731	99, 493
63972	195	65235	261	66165P	414	66355Z	412	66732	99, 493
63973	195	65260	261	66165Z	411	66365	412	66733	489
63974	194	65414	282	66167	411	66365E	207, 416	66734	490
63975	195	65418	282	66172	413	66365H	415	66735	490
63976	194	65420	282	66175	413	66365J	207, 416	66736	489
64407	241, 447	65436	283	66178	413	66365P	414	66737	490
64408	241, 447	65440	283	66202	411	66365Z	412	66738	490
64409	241, 447	65450	283	66202Z	411	66402	412	66742	489
64418	140, 466	65514	293	66210	411	66402Z	412	66745	493
64422	140, 466	65614	282	66210E	206, 416	66410	412	66746	99, 493, 534
64424	136, 464	65618	282	66210H	415	66410E	207, 417	66747	486
64425	140, 466	65620	282	66210J	206, 416	66410H	415	66748	487
64426	136, 464	65636	283	66210P	414	66410J	207, 417	66749	99, 493
64427	136, 464	65640	283	66210Z	411	66410P	414	66752	215
64428	136, 464	65650	283	66212	411	66410Z	412	66753	493
64429	136, 464	65925	495	66215	411	66415	412	66755	212
64430	140, 466	65930	495	66215H	415	66415H	415	66756	212
64431	140, 466	66002	410	66215P	414	66415P	414	66757	212
64432	246	66002Z	410	66215Z	411	66415Z	412	66758	212
64433	246	66010	410	66217	411	66420	412	66759	99, 493
64434	246	66010Z	410	66220	411	66420Z	412	66760	486
64435	140, 466	66012	410	66220H	415	66465	412	66761	486
64436	246	66015	410	66220P	414	66465E	207, 417	66762	486
64437	246	66015Z	410	66220Z	411	66465H	415	66763	487
64439	246	66017	410	66222	411	66465J	207, 417	66764	487
64440	140, 466	66020	410	66240	411	66465P	414	66765	487
64441	140, 466	66020Z	410	66240Z	363, 411	66465Z	412	66765E	207, 417
64444	136, 464	66040	410	66242	411	66502	411	66765J	207, 417
64445	136, 464	66040Z	410	66245	408	66502Z	411	66766	487
64446	136, 464	66042	410	66246	408	66510	411	66767	487
64450	136, 464	66065	410	66247	420	66510Z	411	66768	487
64451	136, 464	66065Z	410	66249	421	66515	411	66769	487
64452	137, 465	66067	410	66255Z	411	66515Z	411	66772	211
64453	137, 465	66099	419	66265	411	66520	411	66773	211
64454	137, 465	66102	411	66265E	206, 416	66520Z	411	66774	445
64455	137, 465	66102Z	411	66265H	415	66540	411	66775	492
64457	167, 480	66104	411	66265J	206, 416	66540Z	363, 367	66776	492
64459	137, 465	66110	411	66265P	414	66540Z	411	66777	492
64460	136, 464	66110E	206, 416	66265Z	411	66550	422	66778	492
64461	136, 464	66110H	415	66267	411	66555	421	66779	492
64462	123	66110J	206, 416	66299	419	66565	411	66780	211
64463	123, 137, 465	66110P	414	66302	412	66565E	207, 417	66781	211
64464	123, 137, 465	66110Z	411	66302Z	412	66565J	207, 417	66782	211
64465	123, 137, 465	66112	411	66310	412	66565Z	411	66783	211
64466	123	66115	411	66310E	207, 416	66599	419	66784	212
64467	123	66115H	415	66310H	415	66610	412	66785	212
64468	123	66115P	414	66310J	207, 416	66610E	207, 417	66787	212
64469	123	66115Z	411	66310P	414	66610H	415	66788	212
64470	123	66116	422	66310Z	412	66610J	207, 417	66790	211
64471	123	66117	411	66315	412	66610P	414	66791	211
65012	261	66118	422	66315H	415	66610Z	412	66792	211
65025	261	66120	411	66315P	414	66615	412	66793	211
65031	187	66120H	415	66315Z	412	66615H	415	66800	488
65035	261	66120P	414	66320	412	66615P	414	66801	488
65037	187	66120Z	411	66320H	415	66615Z	412	66802	489
65041	187	66122	411	66320P	414	66620	412	66804	489
65044	140, 466	66140	411	66320Z	412	66620Z	412	66805	489
65046	187	66140Z	411	66340	412	66642	422	66807	488
65050	140, 466	66142	411	66340Z	412	66665	412	66808	489
65060	261	66155	411	66349	421	66665E	207, 417	66816	488
65110	261	66155Z	411	66350	421	66665H	415	66817	488
65135	261	66165	411	66351	421	66665J	207, 417	66819	488
65160	261	66165E	206, 416	66352	421	66665P	414	66820	488
65210	261	66165H	415	66353	421	66665Z	412	66822	489

Ref	Pag	Ref	Pag	Ref	Pag	Ref	Pag	Ref	Pag
66824	489	66911	412	66965H	415	67056	483	67901Z	412
66825	489	66911H	415	66965Z	412	67058	483	67902	412
66826	489	66911P	414	66972	425	67059	483	67902Z	412
66831	209	66911Z	412	66972C	425	67062	483	67903	412
66832	209	66912	412	66974	425	67063	483	67903Z	412
66833	209	66912H	415	66974C	425	67065	483	67904	412
66834	209	66912P	414	66975	425	67066	483	67904Z	412
66835	210	66912Z	412	66977	425	67069	483	67905	412
66836	210	66913H	415	67000	169, 475	67070	483	67905Z	412
66837	210	66913P	414	R67000	169, 475	67071	143, 455	67906	412
66838	210	66914H	415	67001	457	67074	483	67906Z	412
66839	210	66914P	414	R67001	169, 475	67075	143, 455	67909	412
66840	210	66916	482	67002	483	67084	483	67909Z	412
66841	210	66916H	415	R67002	169, 475	67090	484	68000	497
66842	210	66916P	414	R67003	169, 475	67091	484	68001	495
66870	499	66917	482	67004	134, 340	67092	484	68002	495
66871	499	66920	98, 413, 494	R67004	169, 475	67093	484	68003	495
66872	499	66921	98, 413, 494	67005	135, 467	67094	484	68004	495
66874	499	66923	412	R67005	169, 475	67095	484	68005	141
66875	499	66923Z	412	67006	135, 467	67131	143, 455	68006	141
66877	499	66925	412	R67006	169, 475	67133	142, 454	68007	188, 241
66900P	413	66925Z	412	67007	457	67134	160	68008	245, 482
66901	413	66926	482	67008	342	67136	143, 455	68009	244
66901D	412	66927	482	67009	342	67140	468	68010	497
66901DH	415	66930	424	67010	142, 454	67142	469	68017	188, 241
66901DZ	412	66931	425	67011	461	67143	469	68021	244
66901P	414	66932	425	67012	293, 457	67148	468	68023	461
66901Z	413	66933	424	67013	293, 457	67149	468	68024	461
66902	413	66933C	424	67014	293, 457	67150	168, 474	68026	461
66902D	412	66934	424	67015	461	R67150B	168, 474	68030	495
66902DH	415	66934C	424	67016	293, 457	67153	484	68031	495
66902DZ	412	66935	425	67017	293, 457	67156	468	68040	495
66902P	414	66936	424	67018	293, 457	67158	484	68041	495
66902Z	413	66936C	424	67019	293, 457	67163	484	68043	495
66903	413	66936T	424	67020	293, 457	67165	143, 455	68048	495
66903D	412	66937	424	67021	293, 457	67210	142, 454	68049	495
66903DH	415	66937C	424	67022	293, 457	67211	142, 454	68050	461
66903DZ	412	66938	424, 424	67023	293, 457	67212	142, 454	68053	461
66903P	414	66939	424	67025	461	67213	142, 454	68054	461
66903Z	413	66940	424	67026	168, 474	67214	142, 454	68057	461
66904	413	66942	424	67027	134, 340	67215	143, 455	68058	461
66904D	412	66945	425	67028	134, 340	67410	115	68060	495
66904DH	415	66945S	425	67029	135, 467	67412	115	68061	495
66904DZ	412	66945T	425	67030	482	67414	135, 467	68069	469
66904P	414	66947	425	67031	342	67415	115	68070	469
66904Z	413	66948	424	67032	342	67417	115	68078	245, 263
66905	413	66948S	424	67034	450, 548	67420	115	68079	245, 263
66905D	412	66949	424	67036	457	67421	136, 464	68080	141
66905DZ	412	66949S	424	67037	457	67427	136, 464	68082	141
66905Z	413	66949T	424	67038	483	67433	136, 464	68085	151, 299
66906D	412	66950	425	67039	483	67434	136, 464	68087	469
66906DH	415	66951	423	67040	484	67435	136, 464	68090	470
66906DZ	412	66952	423	67041	135, 467	67604	411	68091	469
66906P	414	66953	423	67043	483	67604Z	411	68092	469
66907	412	66956	425	67044	483	67610	411	68099	470
66907P	302	66957	423	67045	483	67610Z	411	68101	157
66908DZ	412	66957S	425	67046	483	67615	411	68102	157
66909	412	66957Z	423	67047	483	67615Z	411	68107	501
66909D	412	R66957A	423	67048	483	67665	411	68120	501
66909DH	415	66958	425	67049	483	67665Z	411	68121	501
66909P	414	66959	425	67050	483	67824	496	68132	470
66910	412	66960	423	67051	608	67828	496	68136	470
66910H	415	66961	423	67052	483	67832	496	68137	470
66910P	414	66962	423	67053	483	67836	496	68141	468
66910Z	412	66965	412	67055	483	67901	412	68142	468

Ref	Pag	Ref	Pag	Ref	Pag	Ref	Pag	Ref	Pag
68150	468	68310	500	68581	501	68736	495	68972	477
68151	468	68340	461	68587	501	68739	98, 494	68973	477
68153	468	68341	461	68588	501	68740	98, 494	68974	473
68154	468	68342	461	68590	501	68741	98, 494	68976	242
68161	469	68350	461	68591	501	68760	491	68977	242
68165	124	68351	461	68597	501	68761	491	68978	242
68166	124	68354	461	68598	501	68762	491	68979	242
68167	124	68357	461	68601	294	68763	491	68980	478
68168	124	68402	170, 476	68602	294	68764	491	68981	472
68169	124	68403	170, 476	68604	170, 476	68765	491	68982	472
68173	125	68404	170, 476	68605	170, 476	68766	491	68983	472
68174	125	68405	170, 476	68607	500	68767	491	68984	473
68175	125	68406	500	68608	500	68768	491	68985	478
68176	125	68407	500	68609	500	68769	491	68987	242
68177	125	68408	500	68610	500	68770	490	68988	472
68178	125	68410	500	68612	500	68808	496	68989	480
68179	125	68411	501	68614	500	68810	496	68991	479
68180	153, 338	68412	500	68616	500	68814	496	68992	479
68181	160	68414	500	68618	500	68818	496	68993	479
68185	126	68416	500	68619	263	68821	496	68994	479
68186	126	68418	500	68620	500	68822	496	68996	479
68187	126	68420	500	68622	500	68823	496	68997	479
68188	127	68422	500	68624	500	68824	496	68998	479
68189	127	68424	500	68626	500	68825	496	68999	479
68195	126, 136, 464	68441	501	68627	263	68827	496	69001	378
68196	127, 140, 466	68460	501	68628	500	68828	496	69002	378, 557
68197	127, 332	68480	501	68629	263	68829	496	69006	242, 380
68198	127, 332	68500	170, 476	68639	263	68831	496	69012	378, 557
68199	127, 139, 463	68501	170, 476	68640	98, 494	68832	496	69015	378
68200	501	68502	170, 476	68641	98, 494	68833	496	R69018	380, 380
68203	501	68506	500	68642	98, 494	68835	496	69019	377
68205	257	68508	500	68643	263	68836	496	69022	385
68213	469	68509	500	68644	263	68842	496	69023	385
68215	257	68510	500	68651	473, 553	68862	496	69024	239
68225	257	68511	482	68652	473, 553	68863	496	69027	380
68235	257	68512	500	68659	98, 494	68882	496	R69027	380
68240	501	68513	482	68660	98, 494	68892	479	69028	380
68246	469	68514	500	68661	262	68893	479	69029	239
68248	495	68516	500	68662	262	68900	478	69030	385
68250	461	68518	500	68663	262	68908	478	69032	395, 546
68252	461	68520	500	68664	262	68910	478	69033	396, 547
68253	461	68522	500	68665	262	68912	478	69034	378
68254	461	68524	500	68666	262	68915	478	69036	559
68265	124	68526	500	68667	262	68928	478	69037	398, 558
68266	124	68532	501	68668	262	68930	477	69038	398, 558
68267	124	68536	501	68669	262	68932	478	69039	398, 558
68268	124	68537	501	68676	498	68934	478	69041	139, 260, 463
68269	124	68538	501	68680	498	68935	477	69042	602
68270	120	68540	501	68684	498	68936	497	69045	397, 560
68271	120	68544	501	68686	498	68937	477	69046	602
68272	120	68546	501	68688	498	68939	477	69047	602
68273	120	68547	501	68696	498	68940	477	69048	602
68274	120	68548	501	68714	497	68942	478	69050	599
68275	120	68550	501	68716	497	68945	477	69051	602
68276	120	68552	501	68718	497	68948	478	69052	602
68280	128	68554	501	68720	188, 241	68950	477	69053	602
68281	128	68556	501	68723	496	68954	477	69054	602
68282	128	68557	501	68724	496	68955	477	69055	602
68283	128	68558	501	68725	497	68960	477	69056	602
68284	128	68560	501	68726	495	68964	477	69057	602
68285	141	68566	501	68729	496	68965	477	69058	602
68305	339	68567	501	68730	497	68968	473	69059	602
68306	339	68568	501	68731	495	68969	472	69061	400, 562
68307	339	68570	501	68732	496	68970	477	R69061A	400, 562
68308	500	68580	501	68735	497	68971	477	69062	581

Ref	Pag	Ref	Pag	Ref	Pag	Ref	Pag	Ref	Pag
69064	581	69169	537	69272	574	69354	601	69483	514
69065	392, 579	69170	538	69273	574	69355	601	69485	252, 572
69066	392, 579	69172	392, 579	69274	574	69356	600	69486	381, 573
69068	528	69173	392, 579	69275	574	69357	600	69488	587
69070	613	69179	548	69276	266, 570	69360	391, 582	69490	527
69072	610	69184	611	69277	265, 569	69361	400, 562	69492	607
69073	527	69185	611	69278	574	69362	395, 546	69500	530
69075	613	69186	611	69279	575	69363	393, 581	69501	445
69077	527	69187	611	69280	585	69365	401, 563	69503	531
69078	610	69192	606	69281	575	69367	401, 563	69504	531
69079	533	69193	607	69282	575	69368	528	69505	531
69081	595	69195	592	69283	583	69369	528	69506	531
69084	512	R69195B	593	69285	585	69371	395, 546	69507	531
69087	374	R69195N	593	69286	583	69373	588	69508	539
69088	375	69196	552	69287	585	69374	515	69509	541
69089	373	69197	549	69288	587	69379	548	69510	531
69091	373	69202	440	69289	266, 570	69380	588	69511	540
69092	374	69203	440	69291	265, 569	69382	589	69512	531
69093	375	69204	440	69292	266, 570	69384	515	69514	531
69094	375	69205	440	69294	392, 579	69385	237, 252, 572	69518	531
R69094A	375	69207	440	69295	592	69386	590	69520	586
69095	374	69208	441	R69295A	593	69387	591	69521	172
69096	377	69211	441	R69295B	593	69388	512	69523	534
69097	376, 377	69212	441	R69295D	593	69389	589	69530	598
69098	376	69213	440	69296	392, 579	69396	253, 578	69531	598
69099	373	69214	439	69297	265, 569	69397	264, 568	69540	598
R69099B	373, 374	69215	441	69298	267, 571	69398	253, 578	69541	598
R69099C	373, 374, 375	69217	439	69300	617	69400	629	69543	508
69100	376	69219	608	69302	606	R69400B	629	69547	508
R69100A	376	69221	171	69303	606	R69400N	629	69550	174
R69100B	376, 377	69222	552	69304	606	R69400R	629	69551	174
69101	377	69223	535	69310	616	69401	629	69552	174
69107	221, 242, 380	69225	439	69313	616	69410	626	69553	174
69108	221, 242, 380	69226	439	69314	615	69411	626	69554	173
69109	221, 242, 380	69227	549	69315	509	69414	626	69555	174
69110	378	69230	531	69317	481, 554	69420	627	69556	174
69111	514	69231	584	69318	398, 556	69421	627	69557	174
69115	509, 533	69232	393, 544	69319	398, 556	69422	627	69558	174
69116	597	69233	506	69320	614	69423	627	69559	174
69118	529	69234	440	69321	171	69424	628	69560	174
69120	584	69235	439	69322	543	69425	628	69561E	504
69121	535	69236	440	69323	543	69426	628	69561F	504
69122	552	69237	440	69324	543	69427	628	69561I	504
69123	535	69238	612	69325	544	69428	255, 577	R69561A	505
69125	529	69239	612	69327	542	69429	254, 576	R69561B	505
69130	529	69240	439	69330	543	69440	580	R69561C	505
69131	373, 374, 376	69241	440	69332	395, 546	69442	580	R69561D	505
69132	394, 545	69242	559, 559	69333	396, 547	69444	580	R69561E	505
69134	538	69243	511	69336	379, 557	69445	397, 560	R69561F	505
69135	538	69244	510, 510	69337	394, 545	69450	471, 556	R69561N	505
69136	190	69245	510	69338	591	69451	602	R69561P	505
69138	396, 547	R69245B	510	69339	591	69452	602	R69561Q	505
69139	375	69246	511	69340	615	69453	602	R69561S	505
69140	190	69248	440	69341	359, 620	69454	602	R69561T	505
69141	359, 620	69249	440	69343	507	69455	602	R69561V	505
69145	397, 560	69250	439	69344	507	69458	602	R69561W	505
69146	190	69251	439	69345	511	69459	602	R69561Z	505
69151	599	69256	255, 577	69346	506	69465	536	69562	399, 561
69152	190	69259	602	R69346F	506	69466	537	69563	399, 561
69156	190	69260	391, 582	69347	542	69468	537	69564	401, 563
69163	393, 581	69261	359, 620	69348	550	69469	537	69565	401, 563
69165	190	69263	400, 562	69349	553	69471	382, 573	69566	401, 563
69166	551	69264	400, 562	69350	599	69472	382, 573	69567	174
69167	551	69266	401, 563	69352	597	69476	382, 573	69568	174
69168	190	69267	398, 558	69353	599	69481	381, 573	69574	551

Ref	Pag	Ref	Pag	Ref	Pag	Ref	Pag	Ref	Pag
69575	585	69850	520	72628	35	85126	46	88922	45
69579	532	71318	93	72629	35	85128	46	88924	45
69581	595	71320	93	72632	35	85129	47	88926	45
69583	513	71322	93	72714	35	85212	46	88928	45
69584	513	71324	93	72716	35	85214	46	88932	45
69587	595	71326	93	72720	35	85216	46	90016	40
69590	265, 569	71328	93	72803	117	85218	46	90018	40
69591	265, 569	71711	221	72804	117	85220	46	90020	40
69601	303, 402, 564	71780	221, 242, 380	72805	117	85420	47	90022	40
69602	304, 403, 565	71784	71	72806	117	85424	47	90024	40
69603	304, 403, 565	71786	71	72807	117	85624	47	90026	40
69604	306, 405, 567	71788	71	72808	117	85625	47	90028	40
69605	305, 404, 566	71818	93	72809	117	85629	47	90032	40
69606	305, 404, 566	71820	93	72810	117	85712	47	90116	40
69607	306, 405, 567	71822	93	72811	117	85714	47	90118	40
69615	555	71824	93	72850	116	85716	47	90120	40
69617	481, 554	71826	93	72851	116	85718	47	90122	40
69670	611	71828	93	72853	116	85916	47	90124	40
69671	611	71862	72	72854	116	85918	47	90125	40
69672	611	71864	72	72855	116	85920	47	90126	40
69673	611	71866	72	72856	116	85922	47	90128	40
69683	513	71868	72	72857	116	85924	47	90129	40
69684	513	71871	71	72858	116	85926	47	90132	40
69685	513	71872	71	72859	116	85928	47	90212	40
69700	612	71874	71	72916	35	88016	44	90214	40
69701	612	71875	71	72918	35	88018	44	90216	40
69702	612	71876	71	72920	35	88020	44	90218	40
69703	612	71878	71	72924	35	88022	44	90220	40
69722	517	71884	72	72928	35	88024	44	90318	41
R69722J	517	71886	72	72932	35	88026	44	90324	41
69723	517	71887	72	79016	36	88028	44	90420	41
69735	520	71914	81	79020	36	88032	44	90424	41
R69735J	520	71916	81	79024	36	88116	44	90620	41
69736	520	71918	81	79028	36	88118	44	90622	41
69750	520	71920	81	79116	36	88120	44	90624	41
69751	520	71922	81	79120	36	88121	44	90626	41
69761	518	71924	81	79124	36	88122	44	90628	41
69762	518	71926	81	79128	36	88124	44	90632	41
69763	518	71928	81	79214	37	88125	44	90712	41
69764	518	71932	81	79216	37	88126	44	90714	41
69765	518	72016	34	79218	37	88128	44	90716	41
69771	518	72020	34	79220	37	88129	44	90718	41
69772	518	72024	34	79420	37	88132	44	90916	41
69773	518	72028	34	79424	37	88212	44	90918	41
69774	518	72032	34	79624	37	88214	44	90920	41
69775	518	72116	34	79628	37	88216	44	90922	41
69781	519	72120	34	79714	37	88218	44	90924	41
69782	519	72124	34	79830	37	88220	44	90926	41
69783	519	72125	34	79916	37	88318	45	90928	41
69784	519	72128	34	79920	37	88324	45	90932	41
69785	519	72129	34	79924	37	88420	45	91520	443
69791	519	72132	34	79928	37	88424	45	91521	443
69792	519	72214	34	85003	47	88620	45	91522	444
69793	519	72216	34	85016	46	88622	45	91523	444
69794	519	72218	34	85018	46	88624	45	91525	443
69795	519	72220	34	85020	46	88626	45	91530	451
69801	517, 520	72318	35	85022	46	88628	45	91533	451
69803	517, 520	72324	35	85024	46	88632	45	R91533A	451
69815	517	72420	35	85026	46	88712	45	91540	444
69816	517	72423	35	85028	46	88714	45	91541	444
69820	520	72424	35	85118	46	88716	45	91542	444
69824	520	72428	35	85120	46	88718	45	98803	122
69825	520	72620	35	85122	46	88916	45	98804	122
69830	520	72624	35	85124	46	88918	45	98806	122
69840	520	72625	35	85125	47	88920	45	98807	122

Ref	Pag
98808	122
98810	122
98811	122
98903	121
98904	121
98905	121
98906	121
98907	121
98908	121
98909	121
98910	121
98911	121
98912	121
98913	121
98914	121



**Índice alfabético**



**Sommaire alphabétique**



**Alphabetisch Index**



**Alphabetical Index**



**Indice alfabético**



<b>A</b>			
ABLANDACARNE	157		
ABRE OSTRAS	248, 331		
ABREBOTELLAS	295		
ABRELATAS	331, 358		
ACEITERA	234		
AERÓGRAFO	471, 556		
AFILADOR CUCHILLOS	358, 359, 620		
AGUJA DE MECHAR	166		
AHUMADOR	171, 172		
AIR POT	271, 382, 573		
AIREADOR DE VINO	299		
AIRPOT	382, 573		
ANILLA ANTI-GOTEO	299		
ARMARIO ESTERILIZADOR	611, 612, 621		
ARMARIO REFRIGERADOR	610, 611, 612		
ARO	495, 500, 501		
ARO PERFORADO	501		
ARROCERA	506		
ASA DE SILICONA	53, 104		
ASADOR	79		
ASADOR DE SALCHICHAS	508		
ATRILPORTA MENÚ	249, 309		
AZUCARERO	240, 261		
<b>B</b>			
BANDEJA	423		
BANDEJA / FUENTE	186, 187, 188, 189, 192, 193, 194, 195, 196, 197, 198, 200, 201, 202, 203, 241		
BANDEJA AUTOSERVICIO	423		
BANDEJA AUTOSERVICIO	423		
BANDEJA CAMARERO	187, 190		
BANDEJA HORNO	30		
BANDEJA ISOTÉRMICA	424		
BAÑO MARIA	25, 27, 481, 554, 559		
BARRA SUJECCIÓN NOTAS	130		
BÁSCULA	176, 177, 178, 179, 180, 457, 619		
BATIDOR	121, 127, 136, 138, 139, 260, 462, 463, 464, 515		
BATIDORA	512, 513, 514, 515, 517, 518, 519, 520, 521, 522, 523, 524, 525, 526, 528, 530, 531, 532, 533, 535		
BIBERÓN DECORACIÓN	167, 480		
BOBINA FILM	448		
BOBINA VACÍO	602		
BOL	144, 145, 146, 193, 195, 198, 199, 200, 201, 202, 238, 424, 425, 456, 458, 459		
BOLAS AISLANTES SOUS VIDE	608		
BOLSAS VACÍO	602		
BOMBA VACÍO	298		
BOQUILLA SERVIDORA	299		
BOQUILLAS	478, 479		
BOTELLA BIBERÓN	167, 480		
BOTELLA DOSIFICADORA	57, 62, 222		
BOTELLA PERSONAL	274, 275		
BOTELLERO	278, 289		
BOTES VACÍO	602		
<b>C</b>			
CACEROLA	20, 23, 24, 25, 26, 27, 28, 29, 30, 31, 32, 33, 34, 40, 42, 44, 46, 48, 50, 51, 53, 55, 59, 60, 61, 63, 64, 66, 67, 215, 223, 224, 226, 227, 229		
CACEROLA ALTA	20, 24, 26, 28		
CACEROLA BAJA	51, 59		
CACEROLA OVAL	60, 61, 64, 66, 67, 223, 224, 226, 227		
CACEROLA VAPOR	23, 35, 37, 39, 41, 43, 45, 47, 151		
CACILLO	114, 116, 117, 118, 119, 120, 121, 122, 123, 126, 128, 199		
CACILLO PERFORADO	114, 199		
CACILLO SALSA	116, 117, 118, 121, 122, 129		
CADENA	495		
CAFETERA	254, 255, 256, 257, 258, 259, 261, 576, 577		
CAFETERA GOTEO	574, 575		
CAFETERA PERCOLADORA	381, 573		
CALDERO	147, 460		
CALENTADOR	397, 398, 399, 558, 559, 560, 561, 626, 627, 628, 629		
CALENTADOR CHAFING	378, 557		
CALENTADOR LÍQUIDOS	380		
CAMINO DE MESA	211		
CAMPANA AHUMADOR	172, 173		
CAMPANILLA	241		
CARRO SERVICIO	420, 421, 422, 425		
CASCANUECES	248		
CAZO BOMBADO	29		
CAZO CÓNICO	22, 25		
CAZO FRANCÉS	22, 25		
CAZO RECTO	21, 25, 27, 29, 33, 34, 37, 38, 40, 42, 43, 44, 46, 47, 48, 50, 53, 55, 57, 59, 61, 62, 79, 115, 222		
CAZO RECTO ALTO	21, 25, 27, 29		
CEDAZO	461		
CENICERO	241, 450		
CENTRIFUGADORA	164, 165		
CEPILLO PARA TABLA CORTE	367		
CEPILLO RECOGEDOR	241, 447		
CESTA	439, 440, 441		
CESTILLO	230, 231		
CHAFING DISH	373, 374, 375, 376, 377, 378, 379, 557		
CHAIRA	351, 355		
CHOCOLATERA	555		
CIERRE PORTAFICHAS	425		
CLIPADORA	163		
COCEDOR AL VAPOR	535		
COCEDOR DE HUEVOS	507		
COCEDOR DE SALCHICHAS	508		
COCTELERA	292		
COLADOR	35, 39, 41, 43, 45, 115, 149, 150, 294		
COLGADOR	130, 289		
CONTENEDOR ALIMENTOS	161		
CONTENEDOR CUBIERTOS	130		
COOKINGME	504, 505		
COPA	483		
COPAS/VASOS	286, 287		
CORDEL COCINA	99		
CORDÓN DE CUERO	314		
CORTA VEGETALES	509, 530, 531, 533		
CORTADOR	152, 153, 330, 331, 333, 336, 337, 338, 339, 531		
CORTADORA FIAMBRE	529		
CORTAPASTAS	469		
CORTAPIZZA	134, 340		
CREPERA	77, 80, 83, 88, 552		
CUBERTERO	213, 369, 390		
CUBETA	206, 207, 408, 410, 411, 412, 413, 414, 415, 416, 417		
CUBETA PERFORADA	410, 411		
CUBIERTOS	368		
CUBITERA	282, 293		
CUBO	147		
CUBO ENFRIABOTELLAS	279, 280, 281, 282, 283		
CUBRE QUESO/TARTA	239		
CUBREPLATOS	239, 390, 425		
CUCHARA APOYA UTENSILIOS	115		
CUCHARA LISA	114, 116, 117, 118, 119, 120, 121, 122, 123, 124, 125, 126, 128, 137, 199, 202, 465		
CUCHARA MIEL	248		
CUCHARA OBLICUA	114		
CUCHARA PERFORADA	114, 116, 117, 118, 121, 122, 125, 199		
CUCHARILLA COCKTAIL	295		
CUCHILLO	250, 330, 331, 332, 350, 351, 352, 353, 354, 355		
CUECE ESPECIAS	151		
CUECEPASTAS	35, 39		
<b>D</b>			
DELANTAL	100		
DESCÁPSULADOR	299		
DESCORAZONADOR	331, 332, 339		
DESESCAMADOR DE PESCADO	249		
DESHIDRATADOR	534, 535		
DESHOJADOR DE HIERVAS	153, 338		
DISPENSADOR	235, 384, 385, 448		
DISPENSADOR JABÓN	443, 444		
DISPENSADOR REPOSTERÍA	168, 474		
DOBLE FONDO	412, 414, 415		
DOSIFICADOR	168, 169, 474, 475		
DOSIFICADOR LICOR	294		
<b>E</b>			
EMBUDO	151, 299		

EMBUTIDORA MANUAL	163	MANO CHINO	149
ENCENDEDOR	242	MANO MORTERO	158
ENSALADERA	238	MANOPLA	61, 83, 100, 104
ESCURREFRITOS	148	MANTEL INDIVIDUAL	209, 210, 211, 212
ESCURREPLATOS	445	MÁQUINA CUBITOS HIELO	614, 615
ESCURRIDERA	35, 39, 41, 43, 45, 148	MÁQUINA DE HELADO	509, 615
ESPÁTULA	120, 123, 124, 126, 133, 136, 137, 250, 464, 465	MÁQUINA ENFRIACOPAS	617
ESPÁTULA LISA	114, 117, 118, 119, 121, 123, 125, 132, 133, 134, 136, 137, 331, 464, 465	MÁQUINA VACÍO	597, 598, 599, 600, 601
ESPÁTULA PERFORADA	114, 116, 117, 121, 122, 123, 124, 125, 126, 128	MARCADOR TARTA	482
ESPÁTULA PIZZA	134	MARTILLO	157
ESPECIERO	235	MATAMOSQUITOS	622, 623, 624
ESPUMADERA	114, 115, 116, 117, 118, 119, 120, 121, 122, 123, 127, 128	MAZA	294
ESPUMADOR DE LECHE	253, 578	MEDIDOR	142, 143, 144, 454, 455, 456, 457
ESTANTE TUBULAR	422	MEDIDOR PASTA	162
ESTANTERIA	428, 429, 430, 431, 432, 433, 434, 435, 436	MICROONDAS	543, 544
ESTECAS	470	MINI GRILL	65, 67, 225, 227
EXPRIMIDOR	160, 161, 583, 584, 585, 586, 588	MINI-CUBO	231
<b>F</b>		MOLDE EMPANADILLAS	157
FLANERO	493, 495, 496	MOLDE HUEVO	141
FONDUE	221	MOLDE PIZZA	496
FREIDORA	537, 538, 539, 540, 541	MOLDE REPOSTERÍA	486, 487, 488, 489, 490, 491, 492, 493, 495, 496, 497, 498, 501
FRUTEROS	220, 389	MOLDES BOMBÓN	499
FUENTE CHOCOLATE	398, 556	MOLINILLO	236, 237, 252, 572
FUENTE HONDA	147, 460	MORTERO	158
FUENTE PARA MANTEQUILLA	239	<b>N</b>	
FUNDA CARRO	421	NIDOS ALAMBRE	115
FUNDA ENFRIABOTELLAS	277	NÚMEROS MESA	240, 287
<b>G</b>		<b>O</b>	
GANCHOS	130, 352	OLLA	21, 24, 27, 29, 32, 34, 36, 38, 40, 42, 44, 46, 50, 55, 450, 548
GARRAS DE OSO	155, 335	OLLA A PRESIÓN	69, 70, 71, 72
GEL COMBUSTIBLE	221, 242, 380	OLLA BAJA	21, 24
GOFRERA	553	OLLA SUPER ALTA	34, 38, 40, 42, 44, 47
GRILL	53, 59, 83, 86, 88	ORGANIZADOR ACCESORIOS CÓCTEL	292
GUANTE	100, 101, 102, 103, 349	ORGANIZADOR DE CAFÉ	383
GUIA DIVIDORA	412	<b>P</b>	
<b>H</b>		PAELLERA	21, 24, 27, 29, 61, 62, 63, 79, 83, 107, 108, 109, 110, 111, 222, 231
HARINERO	148	PAJITAS	591
HERVIDOR	151	PALA	134
HERVIDOR AGUA	263, 264, 265, 266, 267, 568, 569, 570, 571	PALA ENSALADA	116
HERVIDOR PESCADO	30	PALA PARA PATATAS FRITAS	141
HORNO	542	PALA PASTEL	116, 331
<b>I</b>		PALA PESCADO	114, 120, 121
INDICADOR RESERVADO	240	PALA PIZZA	134
<b>J</b>		PALILLERO	233
JAMONERO	348	PANERA	216, 217, 218, 219, 220, 386, 387, 388, 389
JARRA DE AGUA	284, 285, 383, 425	PAPELERA	241, 446, 447
JARRA SEPARADOR GRASA	234	PARRILLA	98, 413, 494
JARRA TERMO	269, 270	PASAPURÉS	156, 157
JUEGO DE COCINA	118	PEINE CARNE	340
JUEGO DE UTENSILIOS DE COCTELERÍA	290	PEINE DECORACIÓN	470
JUEGO SALERO-PIMENTERO	233, 234	PELADOR	127, 330, 331, 332, 333
JUEGO VINAGRERAS	233, 234	PICADORA	154, 155, 334, 335, 527
<b>L</b>		PICADORA CARNE	528
LÁMINA	99, 493, 534	PICADORA HIELO	293, 616
LAMINADOR	162, 333, 340	PIE PORTACUBOS	278
LÁMPARA CALENTAMIENTO	398, 400, 401, 558, 562, 563	PINCEL	123, 127, 136, 137, 140, 250, 464, 465, 466
LECHERA	260, 261	PINCHO MARISCO	248
LEGUNBRERA	238	PINCHO MARUNO	130
LIBRADOR	293, 457	PINZA	98, 123, 244, 245, 246, 247, 248, 249, 250, 293, 413, 482
LICUADORA	587	PINZAS	98, 245, 248, 263, 413
<b>M</b>		PIPETA PARA SALSA	166
MACHETE	351	PISTOLA GAS	472, 473
MALETA CUCHILLOS	352	PISTOLA REPOSTERÍA	480
MALETÍN BBQ	250	PIZARRA	299, 300, 301, 310, 618
MANDOLINA	344, 345	PLACA CALENTAMIENTO	378, 397, 557, 560, 575
MANGA REPOSTERÍA	477	PLACA HORNO	98, 494
		PLACA INDUCCIÓN	373, 374, 375, 376, 394, 395, 396, 545, 546, 547
		PLACA VITROCERÁMICA	393, 544
		PLANCHA GRILL	80, 83, 84, 548
		PLANCHA-GRILL	549, 551

PLATO	193, 195, 203, 424, 425	TAPA	22,25,27,30,33,35,37,39,41,43,45,47,49,53,55,57,59,69,81,96
PLATO CAMPING	188	TAPA P/CUBETA	412, 413, 414, 415
PLATO DE HUEVOS	188	TAPETE	99, 493
PORTA COMANDAS	317, 318	TAPETE COCTELERÍA	291
PORTA FACTURAS	317, 318	TAPÓN	299
PORTA MENÚ	310,314,315,316,317,318,319,320,321,322,323,324,325,326,327	TARTERA	33, 35, 37, 39, 41, 43, 45, 53, 55
PORTARROLLOS	449	TAZA	424
PORTATARTA	197, 482	TENAZA MARISCO	248
POSABOTELLAS	188	TENEDOR	114, 116, 117, 118, 119, 124, 125, 250, 351, 354
POSAVASOS	188	TERMO	271, 272
POSTE SEPARADOR	451	TERMÓMETRO	129, 181, 182, 183
POTE CILINDRICO	29, 35, 37, 39, 41, 43, 45, 47	TERMOTRANS	419
PRENSA AJOS	331	TETERA	261, 262
PRENSA HAMBURGUESAS	159	TIJERAS	356
PULVERIZADOR	234	TOSTADORA	391, 392, 393, 579, 580, 581, 582
		TRIANGULO	150
		TRITURADOR MANUAL DE TOMATE	156, 340
<b>Q</b>		<b>V</b>	
QUEMADOR	473, 553	VASO	200, 273, 287, 425
QUESERA	238, 240, 364	VASOS CUBERTERÍA	287, 369
		VITRINA EXPOSITORA	302,303,304,305,306,402,403,404,405,564,565,566,567
<b>R</b>		<b>W</b>	
RACIONADOR HELADO	483, 484	WOK	37, 49, 77, 80, 82, 88, 92, 396, 547
RALLADOR	340, 341, 342, 343		
RASERA	115, 341	<b>Y</b>	
RASQUETA	135, 467, 470	YOGURTERA	510, 511
RECLLETTE	550		
REFRIGERADOR	613		
REJILLA PARA SOUS VIDE	608		
REJILLA REPOSTERÍA	482		
RELOJ COCINA	105, 183		
RIBETEADOR DE COPAS Y VASOS	292		
ROBOT MULTIFUNCIÓN	533		
RODILLO	468, 469		
ROTULADORES PIZARRA	301, 618		
RUSTIDERA	25, 30, 95, 96, 97		
<b>S</b>			
SACACORCHOS	296, 297, 609		
SALAMANDRA	549		
SALSERA	238		
SALVAMANTELES	214, 215		
SARTÉN	33,39,47,49,53,55,57,59,62,74,75,76,77,78,79,82,85,86,87,88,89,90,91,92,93,222		
SAUTEX	22, 25, 27, 35, 47, 49		
SECADOR MANOS	445		
SELLOS PARA GALLETAS	470		
SEPARADOR CLARAS	141		
SERRÍN MADERA	174		
SERVIDOR ESPAGUETIS	117, 118, 120, 121, 122, 123, 128		
SERVIDOR ZUMOS	380		
SERVILLETERO	240, 449		
SET REPOSTERIA	136, 464		
SIFÓN	170, 476		
SIFÓN AGUA	294		
SOPERA	238		
SOPORTE BATIDORA BRISK	517, 520		
SOPORTE CALDERO	147, 460		
SOPORTE COPAS	288, 289		
SOPORTE CUBIERTOS	369		
SOPORTE MAGNÉTICO	357		
SOPORTE MENU	240		
SOPORTE MESA ENFRIABOTELLAS	278		
SOPORTE PAELLERA	111		
SOPORTE PAELLERA GAS BUTANO	111		
SOPORTE PARA BANDEJAS	187		
SOPORTE PARA HUEVO	141		
SOPORTE PARA ROLLO	598		
SOUS VIDE	606, 607		
SUJETA MANTELES	240		
<b>T</b>			
TABLA DE CORTE	348, 360, 361, 362, 363, 364, 365, 366, 367		
TABLA SERVIR	204, 228, 231, 232		
TACO CUCHILLO	351, 352		

## A

AÉRATEUR DE VIN	299
AÉROGRAPHE	471, 556
AFÛTEUSE DE COUTEAUX	358, 359, 620
AIGUILLE À LARDER	166
AIR POT	271, 382, 573
AIRPOT	382, 573
ALLUME-GAZ	242
ANNEAU STOP GOUTTLES À VIN	299
APPAREIL ANTI-MOUSTIQUES	622, 623, 624
ARAIGNEE	115, 341
ARDOISE	299, 300, 301, 310, 618
ARMOIRE À STÉRILISER	611, 612, 621
ASSIETTE	193, 195, 203, 424, 425
ATTENDRISEUR À VIANDE	157

## B

BAC	206, 207, 408, 410, 411, 412, 413, 414, 415, 416, 417
BAC PERFORE	410, 411
BAHUT	25, 27, 481, 554, 559
BAIN MARIE	373, 374, 375, 376, 377, 378, 379, 557
BALANCE	176, 177, 178, 179, 180, 457, 619
BARRE À NOTES	130
BASSINE	147, 460
BASSINE PÂTISIERE	147, 460
BATTEUR	512,513,514,515,517,518,519,520,521,522,523,524,525,526,538,539,540,591,592,593,595
BEC VERSEUR	299
BEURRIER AVEC COUVERCLE	239
BIBERON À DECORER	167, 480
BILLES ISOLANTES SOUS VIDE	608
BLOC COUTEAU	351, 352
BOBINE DE CONSERVATION	602
BOÎTE À CONDIMENTS	161
BOITE À FROMAGE	238, 240, 364
BOÎTES DE CONSERVATION	602
BOL	144, 145, 146, 193, 195, 198, 199, 200, 201, 202, 238, 424, 425, 456, 458, 459
BOUCHON	299
BOUILLORE	263, 264, 265, 266, 267, 568, 569, 570, 571
BOUTEILLE BIBERON	167, 480
BOUTEILLE DOSEUSE	57, 62, 222
BRAISIERE	20, 24, 26, 28
BROCHETTE	130
BROSSE POUR PLANCHE	367
BROYEUR À GLAÇONS	293, 616

## C

CAFETIÈRE	254, 255, 256, 257, 258, 259, 261, 576, 577
CAFETIÈRE FILTRE	574, 575
CASIER	439, 440, 441
CASSE NOIX	248
CASSEROLE	21, 25, 27, 29, 33, 34, 37, 38, 40, 42, 43, 44, 46, 47, 48, 50, 53, 55, 57, 59, 61, 62, 79, 115, 222
CASSEROLE BOMBÉE	29
CASSEROLE FRANÇAISE	22, 25
CASSEROLE HAUTE	21, 25, 27, 29
CASSIER À VIN	278, 289
CENDRIER	241, 450
CERCLE	495, 500, 501
CERCLE PERFOREE	501
CHAÎRE	495
CHARIOT DE SERVICE	420, 421, 422, 425
CHAUFFE	397, 398, 399, 558, 559, 560, 561, 626, 627, 628, 629
CHAUFFE-CAFÉ	380
CHAUFFE-CHAFING	378, 557
CHEMIN DE TABLE	211
CHOCOLATIÈRE	555
CISEAUX	356
CLIPPEUSE	163
CLOCHE À FUMER	172, 173
CLOCHES	239, 390, 425
COCOTTE À PRESSION	69, 70, 71, 72
COOKINGME	504, 505
CORBEILLE À FRUITS	220, 389
CORDON EN CUIR	314

COUPE	483
COUPE CAPSULE	299
COUPE PATE	135, 467, 470
COUPELLE	424
COUPER	152, 153, 330, 331, 333, 336, 337, 338, 339, 531
COUPERET	351
COUTEAU	250, 330, 331, 332, 350, 351, 352, 353, 354, 355
COUTEAU À HUÎTRES	248, 331
COUTELLERIE	213, 369, 390
COUVERCLE	22, 25, 27, 30, 33, 35, 37, 39, 41, 43, 45, 47, 49, 53, 55, 57, 59, 69, 81, 96
COUVERCLE POUR BAC	412, 413, 414, 415
COUVERT	368
COUVRE FROMAGE/GÂTEAU	239
CREMIERE	260, 261
CREPIÈRE	77, 80, 83, 88, 552
CROCHETS	130, 352
CUILLÈRE À GLACE	483, 484
CUILLERE À MIEL	248
CUILLÈRE À SPAGUETIS	117, 118, 120, 121, 122, 123, 128
CUILLÈRE COCKTAIL	295
CUILLÈRE OBLIQUE	114
CUILLÈRE RAMASSE USTENSILES	115
CUILLÈREE LISSE	114, 116, 117, 118, 119, 120, 121, 122, 123, 124, 125, 126, 128, 137, 199, 202, 465
CUILLÈREE PERFOREE	114, 116, 117, 118, 121, 122, 125, 199
CUISEUR À OEUFS	507
CUISEUR À RIZ	506
CUISEUR VAPEUR	535
CUIT-PÂTE	35, 39
CURETTES À HOMARD	248

## D

DÉCAPSULEUR	295
DECOUPOIRS DIVERS	469
DEROULEUR	449
DESHYDRATEUR	534, 535
DESSOUS DE PLATS	214, 215
DIFFUSEUR ÉPICES	151
DISTRIBUTEUR	235, 384, 385, 448
DISTRIBUTEUR	380
DISTRIBUTEUR À SAVON	443, 444
DISTRIBUTEUR DE PÂTISSERIE	168, 474
DISTRIBUTEUR DE SERVIETTES	240, 449
DOUBLE FOND	412, 414, 415
DOUILLES	478, 479

## E

ECUMOIRE	114, 115, 116, 117, 118, 119, 120, 121, 122, 123, 127, 128
EFFEUILLEUSE À HERBES	153, 338
ENSEMBLE D'UTENSILES POUR COCKTAILS	290
ENTONNOIR	151, 299
ENTONNOIR À DECOR	168, 169, 474, 475
ÉPLUCHE	127, 330, 331, 332, 333
ÉPLUCHEUSE	162, 333, 340
ESSOREUSE	164, 165
ÉTAGÈRE TUBULAIRE	422
EXPOSANT PÂTISSERIE	136, 464

## F

FAITOUT	20, 23, 25, 28, 32, 34, 36, 38, 40, 42, 44, 46, 48, 50, 51, 53, 55, 59, 60, 61, 63, 64, 66, 67, 215, 223, 224, 226, 227, 229
FAITOUT BASSE	51, 59
FAITOUT OVALE	60, 61, 64, 66, 67, 223, 224, 226, 227
FER À CAMELISER	473, 553
FEUILLES	99, 493, 534
FIL DE CUISINE	99
FONDUE	221
FONTAINE CHOCOLAT	398, 556
FOUET	121, 127, 136, 138, 139, 260, 462, 463, 464, 515
FOUR	542
FOURCHETTE	114, 116, 117, 118, 119, 124, 125, 250, 351, 354
FRITEUSE	537, 538, 539, 540, 541
FRUIT CENTRIFUGEUSE	587
FUMOIR	171, 172
FUSIL	351, 355

## G

GANT	100, 101, 102, 103, 349
GAUFRIER	553
GEL CHAUFFE	221, 242, 380
GRATTOIR	249
GRIFFES À VIANDE	155, 335
GRILL	53, 59, 83, 86, 88
GRILL	549, 551
GRILL À SAUCISSES	508
GRILLE	98, 413, 494
GRILLE PÂTISSERIE	482
GRILLE-PAIN	391, 392, 393, 579, 580, 581, 582
GUIDE DE DIVISION	412
GURIDON PÂTISSIER	197, 482

## H

HACHOIR	154, 155, 334, 335, 527
HACHOIR	340, 341, 342, 343
HACHOIR LÉGUMES	509, 530, 531, 533
HACHOIR POUR VIANDE	528
HOUSSE CHARIOT	421
HOUSSE REFROIDISSEMENT	277
HUILIER	234

## I

INDICATEUR RÉSEVÉE	240
--------------------	-----

## L

LAMPE DE CHAUFFAGE	398, 400, 401, 558, 562, 563
LEGUMIERE	238
LOUCHE	114, 116, 117, 118, 119, 120, 121, 122, 123, 126, 128, 199
LOUCHE PERFORÉE	114, 199
LOUCHE SAUCE	116, 117, 118, 121, 122, 129

## M

MACHINE À GIVRER LES VERRES	617
MACHINE À GLASÇONS	614, 615
MACHINE À HOT-DOGS	508
MACHINE DE CRÈME GLACÉE	509, 615
MACHINE SOUS VIDE	597, 598, 599, 600, 601
MALLETTE BARBECUE	250
MANCHE EN SILICONE	53, 104
MANDOLINE	344, 345
MARMITE	21, 24, 27, 29, 32, 34, 36, 38, 40, 42, 44, 46, 50, 55, 450, 548
MARMITE BASSE	21, 24
MARMITE S. HAUTE	34, 38, 40, 42, 44, 47
MARQUEUR À GATEAUX	482
MARQUEURS TABLEAU	301, 618
MARTEAU	157
MELLETE DE CHEF	352
MESURE À COCKTAIL	294
MESUREUR POUR PÂTES	162
MESUREUR	142, 143, 144, 454, 455, 456, 457
MICRO-ONDES	543, 544
MINI GRILL	65, 67, 225, 227
MINI-CUBE	231
MINUTEUR DE CUISINE	105, 183
MORTIER	158
MOUFLETTE	61, 83, 100, 104
MOULE À CHAUSSONS	157
MOULE À FLAN	493, 495, 496
MOULE À OEUF	141
MOULE À PÂTISSERIE	486, 487, 488, 489, 490, 491, 492, 493, 495, 496, 497, 498, 501
MOULE À PIZZA	496
MOULE POUR CHOCOLATS	499
MOULIN	236, 237, 252, 572
MOUSSEUR À LAIT	253, 578

## N

NAPPE INDIVIDUEL	209, 210, 211, 212
NUMÉROS DE TABLE	240, 287

## O

ORGANISATEUR DE CAFÉ	383
ORGANISATEUR POUR ACCESSOIRES DE COCKTAIL	292
OUTILS	470
OUVRE-BOÎTE	331, 358

## P

PAILLES	591
PALETTE À GÂTEAU	116, 331
PANIER	230, 231
PANIER À COUVERTS	130
PANIER À NID	115
PANIER MARGUERITE	151
PANIER POUR COUVERT	287, 369
PANIER VAPEUR	23, 35, 37, 39, 41, 43, 45, 47, 151
PANIERE	216, 217, 218, 219, 220, 386, 387, 388, 389
PASSOIRE	35, 39, 41, 43, 45, 115, 149, 150, 294
PASSOIRE A FRITURE	148
PASSOIRE SUR PIED	35, 39, 41, 43, 45, 148
PAT À OEUFS	188
PEIGNE À PATE	470
PEIGNE POUR VIANDE	340
PELLE	134
PELLE À FARINE	293, 457
PELLE A FRITES	141
PELLE À POISON	114, 120, 121
PELLE À SALADE	116
PELLE PIZZA	134
PENDERIE MURATE	130, 289
PERCOLATEUR À CAFÉ	381, 573
PERSONNELLE BOUTEILLE	274, 275
PICHET THERMO	269, 270
PIED POUR RECHAUD	111
PILON	294
PINCE À CASSE-HOMARD	248
PINCE À NAPPE	240
PINCEAU	123, 127, 136, 137, 140, 250, 464, 465, 466
PINCEAU	98, 123, 244, 245, 246, 247, 248, 249, 250, 293, 413, 482
PINCES	98, 245, 248, 263, 413
PISTOLET POUR PÂTISSERIE	480
PLANCHE À DÉCOUPER	348, 360, 361, 362, 363, 364, 365, 366, 367
PLAQUE À FOUR	30
PLAQUE À FOUR	98, 494
PLAQUE À GRILL	80, 83, 84, 548
PLAQUE À INDUCTION	373, 374, 375, 376, 394, 395, 396, 545, 546, 547
PLAQUE POUR CHAUFFANTE	378, 397, 557, 560, 575
PLAQUE VITROCÉRAMIQUE	393, 544
PLAT À ROTIR	25, 30, 95, 96, 97
PLAT E DE CAMPING	188
PLAT ROND	21, 24, 27, 29, 61, 62, 63, 79, 83, 107, 108, 109, 110, 111, 222, 231
PLAT ROND	33, 35, 37, 39, 41, 43, 45, 53, 55
PLATEAU	423
PLATEAU	186, 187, 188, 189, 192, 193, 194, 195, 196, 197, 198, 200, 201, 202, 203, 241
PLATEAU ISOTHERME	424
PLATEAU LIBRE-SERVICE	423
PLATEAU LIBRE-SERVICE	423
PLATEAU LIMONADIER	187, 190
POCHE À DECORER	477
PO-CILINDRIQUE	29, 35, 37, 39, 41, 43, 45, 47
POËLE	33, 39, 47, 49, 53, 55, 57, 59, 62, 74, 75, 76, 77, 78, 79, 82, 85, 86, 87, 88, 89, 90, 91, 92, 93, 222
POIRE À JUS	166
POISSONNIÈRE AVEC GRILLE	30
POMPE À VINE	298
PORTE COUVERTS	369
PORTE CURE DENTS	233
PORTE FICHE	425
PORTE-COMMANDES	317, 318
PORTE-FACTURES	317, 318
PORTE-MENU	310, 314, 315, 316, 317, 318, 319, 320, 321, 322, 323, 324, 325, 326, 327
PORTE-ROULEAU	598
PORTE-SEAU	278
POT À EAU	284, 285, 383, 425
POTEAU SÉPARATEUR	451

## FR Index alphabétique

POUBELLE	241, 446, 447	TAMPONS POUR BISCUITS	470
POUSSOIR À CHINOIS	149	TAPIS	99, 493
POUSSOIR À MORTIER	158	TAPIS ÉGOUTTOIR	445
POUSSOIR MANUEL	163	TAPIS ÉGOUTTOIR	291
PRESSE À HAMBURGUERS	159	THÉIÈRE	261, 262
PRESSE-AGRUMES	160, 161, 583, 584, 585, 586, 588	THERMO	271, 272
PRESSE-PAIL	331	THERMOMETRE	129, 181, 182, 183
PRESSE-PUREE	156, 157	THERMOTRANS	419
PRESSE-TOMATES MANUEL	156, 340	TIRE-BOUCHON	296, 297, 609
PULVÉRISATEUR	234	TORCHE À CARAMÉLISER	472, 473
PUPITRE PORTE-MENU	249, 309	TRANCHEUSE DE CHARCUTERIE	529
		TRIANGLE	150
<b>R</b>		<b>U</b>	
RACK POUR SOUS VIDE	608	USTENSILES DE CUISINE	118
RAMASSE-MIETTES	241, 447		
RAYONNAGE	428, 429, 430, 431, 432, 433, 434, 435, 436	<b>V</b>	
RECHAUD	111	VERRE	200, 273, 287, 425
RECLLETTE	550	VERRES	286, 287
REFROIDISSEUR	613	VIDE-POMMES	331, 332, 339
REFROIDISSEUR À VIN	610, 611, 612	VITRINI DE PRÉSENTATION	302, 303, 304, 305, 306, 402, 403, 404, 405, 564, 565, 566, 567
ROBOT MULTIFONCTIONS	533	<b>W</b>	
RÔTISSOIRE	79	WOK	37, 49, 77, 80, 82, 88, 92, 396, 547
ROULEAU FILM	448		
ROULEAU PATISIER	468, 469	<b>Y</b>	
ROULETTE PIZZA	134, 340	YAOURTIÈRE	510, 511
<b>S</b>			
SACS DE CONSERVATION	602		
SALADIER	238		
SALAMANDRE	549		
SAUCIERE	238		
SAUPOUDREUSE	235		
SAUTASE CONIQUE	22, 25		
SAUTEUSE	22, 25, 27, 35, 47, 49		
SDESSOUS DE BOUTEILLE	188		
SEAU	147		
SEAU À GLACE	282, 293		
SEAU À VIN	279, 280, 281, 282, 283		
SÉCHE-MAINS	445		
SÉPARATEUR À OEUF	141		
SÉPARATEUR DE GRAISSE	234		
SET CALIÈRE ET POIVIERE	233, 234		
SET VINAIGRIE	233, 234		
SHAKER	292		
SIPHON	170, 476		
SIPHON À EAU	294		
SOIRE DE BOIS	174		
SONNETTE	241		
SOUPIERE	238		
SOUS VIDE	606, 607		
SOUS-VERRE	188		
SPATULA	120, 123, 124, 126, 133, 136, 137, 250, 464, 465		
SPATULE LISSE	114, 117, 118, 119, 121, 123, 125, 132, 133, 134, 136, 137, 331, 464, 465		
SPATULE PERFOREE	114, 116, 117, 121, 122, 123, 124, 125, 126, 128		
SPATULE PIZZA	134		
SUCREUR/SALEUR BORDEUR DE VERRES	292		
SUCRIER	240, 261		
SUPPORT À COUPES	288, 289		
SUPPORT CUL DE POULE	147, 460		
SUPPORT D'OEUFS	141		
SUPPORT MAGNETIQUE	357		
SUPPORT MÉLANGEUR BRISK	517, 520		
SUPPORT MENU	240		
SUPPORT POUR JAMBON	348		
SUPPORT POUR PLATEAUX	187		
SUPPORT SEAU	278		
<b>T</b>			
TABLE DE SERVICE	204, 228, 232		
TABLE DE SERVICE	231		
TABLIER	100		
TAMIS	461		
TAMIS À FARINE	148		

# DE Alphabetisch Index

<b>A</b>			
ABTROPFMATTE		445	
ABTROPFSCHÜSSEL	35, 39, 41, 43, 45, 148		
ABTROPFSHÜSSEL FÜR FRITIERTES		148	
ADBECKUNG FÜR TELLERWAGEN		421	
AIRBRUSH		471, 556	
APFELENTKERNER	331, 332, 339		
APPARAT ZUM RAUHRN		171, 172	
ASCHENBECHER		241, 450	
AUSFSCHNITTMASCHINE		529	
AUSGIESS-AUFSATZ		299	
AUSSTELLENDKASTEN, PASTRY		136, 464	
AUSTERMESSER		248, 331	
<b>B</b>			
BACKBLECH		98, 494	
BACKBLECH-AUFLAGE		99, 493	
BACKSCHAUFEL	114, 117, 118, 119, 121, 123, 125, 132, 133, 134, 136, 137, 331, 464, 465		
BACKSCHAUFEL , GELOCH	114, 116, 117, 121, 122, 123, 124, 125, 126, 128		
BAIN MARIE	25, 27, 481, 554, 559		
BATLÖFFEL		295	
BESTECK		368	
BESTECKBEHÄLTER		369	
BESTECKKASTEN	213, 369, 390		
BESTECKKÖCHER		130	
BESTECKKÖCHER		287, 369	
BLACKBLECH		30	
BLÄTTER		99, 493, 534	
BRATENTOPF	20, 23, 28, 32, 34, 36, 38, 40, 42, 44, 46, 48, 50, 51, 53, 55, 59, 60, 61, 63, 64, 66, 67, 215, 223, 224, 226, 227, 229		
BRATENTOPF		51, 59	
BRATPFANNE	25, 30, 95, 96, 97		
BRENNER		473, 553	
BRENNPASTE	221, 242, 380		
BROT-/OBSTKORB	216, 217, 218, 219, 220, 386, 387, 388, 389		
BRULLIERBRENNEN		472, 473	
BRUSH FÜR SCHNEIDEBRETT		367	
BUTTERDOSE MIT DECKEL		239	
<b>C</b>			
CAMPING TELLER		188	
CHAFING DISH	373, 374, 375, 376, 377, 378, 379, 557		
CHAFING HEIZUNG		378, 557	
CHAMPAGNERKÜHLE	279, 280, 281, 282, 283		
COCKTAILMASS		294	
COCKTAIL-MATTE		291	
COCKTAILSHARKER		292	
COCKTAIL-UTENSILIEN		290	
COOKINGME		504, 505	
CRÊPES-PFANNE	77, 80, 83, 88, 552		
<b>D</b>			
DAMPFKOCH-AUFSATZ	23, 35, 37, 39, 41, 43, 45, 47, 151		
DAMPFKOCHGERÄT		535	
DECKEL	22, 25, 27, 30, 33, 35, 37, 39, 41, 43, 45, 47, 49, 53, 55, 57, 59, 69, 81, 96		
DEKORIEREN DOSIERFLASCHE		167, 480	
DEKORIEREN PLASTIKKAMME		470	
DESENÖFFNER		331, 358	
DOPPEL-BODEN	412, 414, 415		
DOSIERER	168, 169, 474, 475		
DOSIERFLASCHE		167, 480	
DOSIERFLASCHE		57, 62, 222	
DREIECK		150	
<b>E</b>			
EIERFORM		141	
EIERKOCHER		507	
EIER-SEPARATOR		141	
EIMER		147	
EIS MACHINE		509, 615	
EIS MACHINEN		614, 615	
EIS-CRUSHER		293, 616	
EISKELCH		483	
EISPORTIONIERER		483, 484	
<b>EITELLER</b>			188
<b>EI-UNTERSTÜTZUNG</b>			141
<b>ELEKTRITOASTER</b>		391, 392, 393, 579, 580, 581, 582	
<b>ELEKTROFLIEGENFÄNGER</b>			622, 623, 624
<b>ELEKTROGRILL</b>			549
<b>ENTBLÄTTERER FÜR GEWÜRZKRÄUTER</b>			153, 338
<b>ESPUMADOR DE LEITE</b>			253, 578
<b>F</b>			
<b>FETTABSCHIEDER</b>			234
<b>FILTERKAFFE</b>			574, 575
<b>FISCHHEBER</b>		114, 120, 121	
<b>FISCHKESSEL</b>			30
<b>FISCHSCHUPPENENTFERNER</b>			249
<b>FLASCHENKÜHLER</b>			277
<b>FLASCHENUNTERSETZER</b>			188
<b>FLEISCHKLOPPER</b>			157
<b>FLEISCHSPIESSE</b>			130
<b>FLEISCHTOPF</b>		20, 24, 26, 28	
<b>FLEISCHWOLF</b>			528
<b>FLEISCHZANGE</b>			340
<b>FOLIENCUTTER</b>			299
<b>FONDUE</b>			221
<b>FRITEUSE</b>		537, 538, 539, 540, 541	
<b>FRITIERLÖFFEL</b>			115, 341
<b>FRÜHSTÜCKSTELLER</b>		193, 195, 203, 424, 425	
<b>G</b>			
<b>GASANZÜNDER</b>			242
<b>GASKOCHER-STÄNDE</b>			111
<b>GEFLÜGELSCHERE</b>			356
<b>GEMÜSESCHEIDER</b>		509, 530, 531, 533	
<b>GEMÜSETOPF</b>			21, 24
<b>GETRÄNKEBELHÄLTER</b>			380
<b>GETRANKENPENDER</b>			382, 573
<b>GETRÄNKESPENDER, ISOLIERT</b>		271, 382, 573	
<b>GEWÜRZDOSE/STREUER</b>			235
<b>GEWÜRZKASTEN</b>			161
<b>GISSLÖFFEL, QUER</b>			114
<b>GLAS</b>		200, 273, 287, 425	
<b>GLASSER</b>			286, 287
<b>GLASUNTERSETZER</b>			188
<b>GN DECKEL</b>		412, 413, 414, 415	
<b>GN ZWISCHENSTENG</b>			412
<b>GN-BEHÄLTER</b>		206, 207, 408, 410, 411, 412, 413, 414, 415, 416, 417	
<b>GN-BEHÄLTER, PERFORIERT</b>			410, 411
<b>GRILL</b>		53, 59, 83, 86, 88	
<b>GRILL</b>		98, 413, 494	
<b>GRILL</b>			549, 551
<b>GRILL AKTENTASCHE</b>			250
<b>GRILLPFANNE</b>			482
<b>GRILLSPIß</b>			79
<b>H</b>			
<b>HACKFLEISCHMESSER</b>			351
<b>HALTERUNG</b>			425
<b>HAMBURGER-FORMEN</b>			159
<b>HAMMER</b>			157
<b>HÄNDETROCKNER</b>			445
<b>HANDPRESSE FÜR TOMATEN</b>			156, 340
<b>HANDSCHUH</b>		61, 83, 100, 104	
<b>HÄNGELEISTE</b>			130, 289
<b>HOHER FLEISCHTOPF</b>		34, 38, 40, 42, 44, 47	
<b>HOLZ-STÖSSEL</b>			149
<b>HONIGBEHÄLTER</b>		235, 384, 385, 448	
<b>HONIGLÖFFEL</b>			248
<b>HOT DOG WÄRMER</b>			508
<b>HUMMERGABEL</b>			248
<b>HUMMERZANGE</b>			248
<b>I</b>			
<b>INDUKTIONSKOCHFELD</b>		373, 374, 375, 376, 394, 395, 396, 545, 546, 547	
<b>ISOLATIONSKUNGLN FÜR SOUS VIDE</b>			608

# DE Alphabetisch Index

ISOTHERMAL SCHALE/TABLETT	424	ÖL-SPRAY	234
<b>J</b>		ORGANIZER FÜR COCKTAILZUBEHÖR	292
JOGHURT-MAKER	510, 511	OVAL BRATENTOPF	60, 61, 64, 66, 67, 223, 224, 226, 227
<b>K</b>		<b>P</b>	
KAFFEE VERANSTALTER	383	PARMESAMENAGE	238, 240, 364
KAFFEEKANNE	254, 255, 256, 257, 258, 259, 261, 576, 577	PASSIERGERÄT	156, 157
KAFFEE-PERKOLATOR	381, 573	PASTETENFORMEN	157
KÄSEREIBE	340, 341, 342, 343	PERSÖNLICHE FLASCHE	274, 275
KASSEROLLE, BAUCHIG	29	PFANNE	21, 24, 27, 29, 61, 62, 63, 79, 83, 107, 108, 109, 110, 111, 222, 231
KEKSSTEMPEL	470	PFANNE	33, 39, 47, 49, 53, 55, 57, 59, 62, 74, 75, 76, 77, 78, 79, 82, 85, 86, 87, 88, 89, 90, 91, 92, 93, 222
KERAMIKKOCHELFELD	393, 544	PFANNE	33, 35, 37, 39, 41, 43, 45, 53, 55
KETTE	495	PINSEL	123, 127, 136, 137, 140, 250, 464, 465, 466
KNOBLAUCHPRESSE	331	PISTOLE FÜR TÜLLENSATZE	480
KOCHER	151	PIZZABLECH	496
KORB	230, 231	PIZZAOFEN-SCHAUFEL	134
KORKEN	299	PIZZASCHNEIDER	134, 340
KORKENZIEHER	296, 297, 609	PIZZASPATEL	134
KRÄTERKOCHSIEB	151	PLATTE GRILL	80, 83, 84, 548
KREISEL	164, 165	PRALINENGIESSFORM	499
KRÜMELBÜRSTE	241, 447	PUDDING-/BECHERFÖRMCHEN	493, 495, 496
KÜCHE ZEICHENKETTE	99	<b>R</b>	
KÜCHENEAAAGE	176, 177, 178, 179, 180, 457, 619	RACK FÜR SOUS VIDE	608
KUCHENFORM	486, 487, 488, 489, 490, 491, 492, 493, 495, 496, 497, 498, 501	RAUCHEMEHL	174
KÜCHENHANDSCHUH	100, 101, 102, 103, 349	RAUCHERGLOCKE	172, 173
KUCHENPLATTE	197, 482	RECLETTE	550
KUCHENSCHAUFEL	116, 331	REISKOCHER	506
KÜCHEN-ZEITSCHALTUHR	105, 183	RESERVED INDIKATOR	240
<b>L</b>		REZEPTIONSKLINGEL	241
LEBENSMITTEL TACKER	163	RINGSTÄNDER	147, 460
LEDERSCHNUR	314	ROLLENHALTER	598
LEISCH BÄRENKRALLEN	155, 335	ROLLFILM	448
LÖFFELSAMMLER IN GESCHIRR	115	RUHRPATEL	134
<b>M</b>		RUNGSTOOLS	470
MAGNETHALTERUNG FÜR MESSER	357	<b>S</b>	
MANDOLINE	344, 345	SAFTBEHÄLTER	380
MANUELLE WURSTTÜLLER	163	SAHNEBEREITER	170, 476
MARKER TAFEL	301, 618	SALATSCHAUFEL	116
MASCHINE FUER GLAS COOL	617	SALATSCHÜSSEL	238
MEHLBEHÄLTER	148	SALZ-PFEFFERTREUER	236, 237, 252, 572
MEHLSCHAUSEL	293, 457	SATZ-PFEFFER-SET	233, 234
MEHLSIEB	461	SAUCENGLIESSLÖFFEL	116, 117, 118, 121, 122, 129
MENAGE	233, 234	SAUCIERE	238
MENÜKARTENHALTER	240	SAUTEUSE	22, 25, 27, 35, 47, 49
MENÜ-STÄNDER	249, 309	SAUTEUSE, KONISCH	22, 25
MESSER	250, 330, 331, 332, 350, 351, 352, 353, 354, 355	SCHÄLER	162, 333, 340
MESSERHALTER	351, 352	SCHÄLER	127, 330, 331, 332, 333
MESSERTASCHE	352	SCHÄRFMASCHINE	358, 359, 620
MESSGERÄT	142, 143, 144, 454, 455, 456, 457	SCHAUFEL	135, 467, 470
METZGERHAKEN	130, 352	SCHAUFEL FÜR POMMES FRITES	141
MIKROWELLE	543, 544	SCHAUMLÖFFEL	114, 115, 116, 117, 118, 119, 120, 121, 122, 123, 127, 128
MILCHKANNE	260, 261	SCHINKENHALTER	348
MILCHTOPF	29, 35, 37, 39, 41, 43, 45, 47	SCHNEEBESEN	121, 127, 136, 138, 139, 260, 462, 463, 464, 515
MINI GRILL	65, 67, 225, 227	SCHNEIDEBRETT	348, 360, 361, 362, 363, 364, 365, 366, 367
MINI-WÜRFEL	231	SCHNEIDER	152, 153, 330, 331, 333, 336, 337, 338, 339, 531
MIXER	512, 513, 514, 515, 517, 518, 519, 520, 521, 522, 523, 524, 525, 526, 588, 589, 590, 591, 592, 593, 595	SCHNELLKOCHTOPF	69, 70, 71, 72
MOJITOSTÖBSEL	294	SCHOKOLADEN FONTÄNE	398, 556
MÖRSER	158	SCHOKOLADENKOCHER	555
MULTIFUNKTIONS-ROBOTER	533	SCHÖPFKELLE	114, 116, 117, 118, 119, 120, 121, 122, 123, 126, 128, 199
<b>N</b>		SCHÖPFKELLE, GELOCHT	114, 199
NESTBACKLÖFFEL	115	SCHÜRZE	100
NUDELKOCH-EINSATZ	35, 39	SCHÜSSEL	144, 145, 146, 193, 195, 198, 199, 200, 201, 202, 238, 424, 425, 456, 458, 459
NUSSKNACKER	248	SCHÜSSEL	147, 460
<b>O</b>		SEIHER, MIT STIEL	35, 39, 41, 43, 45, 115, 149, 150, 294
OBSTSCHALE AUS GITTERSTÄBEN	220, 389	SEKTKÜHLER	282, 293
OBSTTROCKNER	534, 535	SEKTKÜHLERSTÄNDER	278
OFEN	542	SELBSTBEDIENUNGSTABLETT	423
ÖLKANNE	234	SELBSTBEDIENUNGSTABLETT	423
		SERVIERLÖFFEL	114, 116, 117, 118, 119, 120, 121, 122, 123, 124, 125, 126, 128, 137, 199, 202, 465
		SERVIERLÖFFEL, GELOCHT	114, 116, 117, 118, 121, 122, 125, 199
		SERVIERSCHÜSSEL	238



## DE Alphabetisch Index

SERVIERTABLET	423
SERVIERTABLET 186, 187, 188, 189, 192, 193, 194, 195, 196, 197, 198, 200, 201, 202, 203, 241	
SERVIERTABLET	187, 190
SERVIERTISCH	204, 228, 232
SERVIERTISCH	231
SERVIERTWAGEN	420, 421, 422, 425
SERVIETTENPENDER	240, 449
SERVIETTENROLLE	449
SILIKONGRIFF	53, 104
SOSENSPRITZE	166
SOUS VIDE	606, 607
SPAGHETTIHEBER	117, 118, 120, 121, 122, 123, 128
SPAGHETTI-MASS	162
SPEISEKARTENMAPPE 310,314,315,316,317,318,319,320,321,322,323,324,325,326,327	
SPICKNADEL	166
SPRITZBEUTEL	477
SPÜLKORB	439, 440, 441
STÄNDER EISKELCH	288, 289
STÄNDER FUER BRENNER	111
STANDMIXER BRISK	517, 520
STERILISIERUNGSSCHANK	611, 612, 621
STIELKASSEROLLE, FRANZÖSISCH	22, 25
STIELKASSEROLLE, HFLACH 21,25,27,29,33,34,37,38,40,42,43,44,46,47,48,50,53,55,57,59,61,62,79,115,222	
STIELKASSEROLLE, HOCH	21, 25, 27, 29
STÖSSEL	158
STROHHALME	591
SUPPENBEREITER 397, 398, 399, 558, 559, 560, 561, 626, 627, 628, 629	
SUPPENSCHÜSSEL	238
SUPPENTOPF 21, 24, 27, 29, 32, 34, 36, 38, 40, 42, 44, 46, 50, 55, 450, 548	

### T

TABLETTHALTER	187
TAFEL	299, 300, 301, 310, 618
TAFEL FÜR BESTELLUNGEN	317, 318
TAFEL FÜR RECHNUNGEN	317, 318
TASSE	424
TEEKANNE	261, 262
TEIGAUSSTECHER	469
TEIGROLLER	468, 469
TEIGSCHABER 120, 123, 124, 126, 133, 136, 137, 250, 464, 465	
TELLERABDECKUNG	239
TELLERABDECKUNG	239, 390, 425
THERMOBEHÄLTER	271, 272
THERMOMETER	129, 181, 182, 183
THERMOMOSKANNE	269, 270
THERMOTRANS	419
TISCHHALTERUNG	278
TISCHLÄUFER	211
TISCHNUMMERNSCHILD	240, 287
TISCHSET	209, 210, 211, 212
TISCHTUCHKLAMMER	240
TISCH-VITRINE 302, 303, 304, 305, 306, 402, 403, 404, 405, 564, 565, 566, 567	
TISH-ABFALLBEHÄLTER	241, 446, 447
TORTENNING	495, 500, 501
TORTENNING, GELOCHT	501
TORTENTEILER	482
TRANCHIERGABEL 114, 116, 117, 118, 119, 124, 125, 250, 351, 354	
TRICHTER	151, 299
TUBULÄRE REGAL	422
TÜLLENSATZ	478, 479
TÜLLENSÄTZESPENDER	168, 474

### U

UMRANDER FÜR COCKTAILGLÄSER	292
UNTERSATZ	214, 215

### V

VAKUUM-BEHÄLTER	602
VAKUUMBEUTEL	602
VAKUUMBEUTEL ROLLEN	602
VAKUUMIERGERÄT	597, 598, 599, 600, 601
VOLLE REGALE	428, 429, 430, 431, 432, 433, 434, 435, 436
VORLEGETEILE	118

### W

WANDFLASCHENÖFFNER	295
WANDSPENSER SEIFE	443, 444
WANDTRENNPFOSTEN	451
WANNE	147, 460
WÄRMENLAMPE	398, 400, 401, 558, 562, 563
WARMHALTEPLATTE	378, 397, 557, 560, 575
WASSER SAHNEBEREITER	294
WASSERKANNE	284, 285, 383, 425
WASSERWARMER 263, 264, 265, 266, 267, 568, 569, 570, 571	
WEINBELÜFTER	299
WEINKÜHLER	610, 611, 612
WEINKÜHLER	613
WEINPUMPE	298
WEINREGAL	278, 289
WEINRING TROP-STOP	299
WENDEWAFFLEISEN	553
WETZSTAHL	351, 355
WOK	37, 49, 77, 80, 82, 88, 92, 396, 547
WÜRSTCHENGRILL	508

### Z

ZAHNSTOCHERBÜCHSE	233
ZANGE 98, 123, 244, 245, 246, 247, 248, 249, 250, 293, 413, 482	
ZANGES	98, 245, 248, 263, 413
ZELLEHALTER	130
ZITRUS ENTSAFTER	587
ZITRUSPRESSE	160, 161, 583, 584, 585, 586, 588
ZUCKERDOSE	240, 261
ZWIEBELHACKER	154, 155, 334, 335, 527

# EN Alphabetical index

<b>A</b>			
AIR POT		271, 382, 573	
AIRBRUSH		471, 556	
AIRPOT		382, 573	
APPLE CORER		331, 332, 339	
ASHTRAY		241, 450	
<b>B</b>			
BAIN MARIE		25, 27, 481, 554, 559	
BAKING SHEET		98, 494	
BARBECUE BRIEFCASE		250	
BASE FOR BURNER		111	
BASKET		230, 231	
BATTER DISPENSER		168, 474	
BEAR CLAWS FOR MEAT		155, 335	
BIRD'S NEST MOULD		115	
BISCUIT STAMP		470	
BLACKBOARD		299, 300, 301, 310, 618	
BOTTLE COOLER		277	
BOTTLE OPENER		295	
BOTTLE STAND		188	
BOWL 144, 145, 146, 193, 195, 198, 199, 200, 201, 202, 238, 424, 425, 456, 458, 459		147, 460	
BOWL SATND		147, 460	
BREAD BASKET		216, 217, 218, 219, 220, 386, 387, 388, 389	
BRISK BLENDER STAND		517, 520	
BRUSH		123, 127, 136, 137, 140, 250, 464, 465, 466	
BRUSH FOR CUTTING BOARD		367	
BURNER		111	
BUTCHERS		130, 352	
BUTTER DISH WITH COVER		239	
<b>C</b>			
CAKE MARKER		482	
CAKE SPOON		116, 331	
CAKE STAND		197, 482	
CALL BELL		241	
CAMPING PLATE		188	
CAN OPENER		331, 358	
CAP		299	
CARAMIZER		473, 553	
CASSEROLE		202, 232, 233, 334, 424, 464, 485, 515, 535, 596, 616, 666, 715, 232, 242, 262, 272, 292	
CERAMIC HOB		393, 544	
CHAFING DISH		373, 374, 375, 376, 377, 378, 379, 557	
CHAFING HEATER		378, 557	
CHEESE/CAKE COVER		239	
CHINESSE STRAINER PUSHER		149	
CHOCOLATE FOUNTAIN		398, 556	
CHOCOLATE MACHINE		555	
CHOCOLATE MOULD		499	
CHOPPER		154, 155, 334, 335, 527	
CLEAVER		351	
CLING FILM		448	
CLIPPING MACHINE		163	
COCKTAIL ACCESSORY ORGANISER		292	
COCKTAIL MAT		291	
COCKTAIL SET		290	
COCKTAIL SPOON		295	
COCTAIL SHARKER		292	
COFFEE ORGANIZER		383	
COFFEE PERCOLATOR		381, 573	
COFFEE POT		254, 255, 256, 257, 258, 259, 261, 576, 577	
COFFEE URN		380	
COIL TUBE		602	
COLANDER WITH STAND		35, 39, 41, 43, 45, 148	
COLD MEAT CUTTER		529	
CONDIMENTS HOLDER		161	
CONICAL DISH		147, 460	
CONICAL SAUTE PAN		22, 25	
CONTAINER 206, 207, 408, 410, 411, 412, 413, 414, 415, 416, 417		412, 413, 414, 415	
CONTAINER LID		412, 413, 414, 415	
COOKIE CUTTER		469	
COOKIE PRESS		480	
COOKINGME		504, 505	
COOK'S CASE		352	
COOLER		613	
CORKSCREW		296, 297, 609	
COVERING		99, 493	
CREAMER		260, 261	
CREPIERE		77, 80, 83, 88, 552	
CRUET SET		233, 234	
CRUMBS CLEANER		241, 447	
CUP		483	
CUP		424	
CUPS STAND		288, 289	
CUTLERY		213, 369, 390	
CUTLERY		368	
CUTLERY CYLINDER		287, 369	
CUTLERY HOLDER		369	
CUTTER		152, 153, 330, 331, 333, 336, 337, 338, 339, 531	
CUTTING BOARD		348, 360, 361, 362, 363, 364, 365, 366, 367	
CUTTLERY HOLDER		130	
CYLINDRICAL POT		29, 35, 37, 39, 41, 43, 45, 47	
<b>D</b>			
DECORATING COMBRE		470	
DECORATING PEN		167, 480	
DEEP CASSEROLE		20, 24, 26, 28	
DEEP SAUCEPAN		21, 25, 27, 29	
DEEP STOCK POT		34, 38, 40, 42, 44, 47	
DEHYDRATOR		534, 535	
DISH CART COVER		421	
DISH MAT		445	
DISPENSER		235, 384, 385, 448	
DISPLAY VASE 302, 303, 304, 305, 306, 402, 403, 404, 405, 564, 565, 566, 567		412, 414, 415	
DOUBLE BOTTOM		412, 414, 415	
DUMPLING MOULD		157	
<b>E</b>			
EGG COOKER		507	
EGG SERVING DISH		188	
EGG STAND		141	
EGGS SEPARATOR		141	
<b>F</b>			
FILTER COFFE MACHINE		574, 575	
FISH KETTLE WITH GRILL AND LID		30	
FISH SCRAPER		249	
FISH TURNER		114, 120, 121	
FLOUR BIN MESH		148	
FOIL CUTTER		299	
FONDUE		221	
FORK		114, 116, 117, 118, 119, 124, 125, 250, 351, 354	
FRENCH SAUCEPAN		22, 25	
FRUIT BOWL		220, 389	
FRY COLANDER		148	
FRYER		537, 538, 539, 540, 541	
FRYING-PAN 33, 34, 49, 53, 55, 57, 59, 62, 74, 75, 76, 77, 78, 79, 82, 85, 86, 87, 88, 89, 90, 91, 92, 93, 222		221, 242, 380	
FUEL GEL BUCKET		221, 242, 380	
FUNNEL		151, 299	
<b>G</b>			
GARLIC PRESS		331	
GAS LIGHTER		242	
GAS TORCH		472, 473	
GLAS RIMMER		292	
GLASS		200, 273, 287, 425	
GLASS COOLER MACHINE		617	
GLASS STAND		188	
GLASSES		286, 287	
GLOVE		100, 101, 102, 103, 349	
GRATER		340, 341, 342, 343	
GRAVY BOAT		238	
GRAVY LADLE		116, 117, 118, 121, 122, 129	
GRAVY/FAT SEPARADOR		234	
GRILL		53, 59, 83, 86, 88	
GRILL		98, 413, 494	

## EN Alphabetical index

GRILL 549, 551  
GRILL PLAQUE 80, 83, 84, 548  
GRINDER 236, 237, 252, 572

### H

HAMBURG PRESSER 159  
HAMMER 157  
HAM-SUPPORT 348  
HAND DRYER 445  
HEATER 397, 398, 399, 558, 559, 560, 561, 626, 627, 628, 629  
HEATING LAMP 398, 400, 401, 558, 562, 563  
HERB STRIPPER 153, 338  
HONEY SPOON 248

### I

ICE BUCKET 282, 293  
ICE CREAM MAKING MACHINE 509, 615  
ICE CREAM SCOOP 483, 484  
ICE CRUSHER 293, 616  
ICE CUBES MAKER 614, 615  
ICE SHOVEL 293, 457  
INDEX CARD FASTENER 425  
INDIVIDUAL PLACEMENT 209, 210, 211, 212  
INDUCTION PLATE 373, 374, 375, 376, 394, 395, 396, 545, 546, 547  
ISOTHERMAL TRAY 424

### J

JIGGER 294  
JUICE DISPENSER 380  
JUICE EXTRACTOR 587

### K

KETTLE 263, 264, 265, 266, 267, 568, 569, 570, 571  
KITCHEN STRING 99  
KITCHEN TIMER 105, 183  
KITCHEN TOOL SET 118  
KNIFE 250, 330, 331, 332, 350, 351, 352, 353, 354, 355  
KNIFE BLOC 351, 352  
KNIFE SHARPENER 358, 359, 620  
KNIFE STERILIZATION 611, 612, 621  
LADLE 114, 116, 117, 118, 119, 120, 121, 122, 123, 126, 128, 199  
LEATHER LACE 314  
LID 22, 25, 27, 30, 33, 35, 37, 39, 41, 43, 45, 47, 49, 53, 55, 57, 59, 69, 81, 96  
LOBSTER CRACKER 248  
LOW CASSEROLE 51, 59  
LOW STOCK POT 21, 24

### M

MACE 294  
MAGNET SUPPORT 357  
MANDOLINE 344, 345  
MANUAL STUFFER 163  
MANUAL TOMATO CHOPPER 156, 340  
MARKERS BLACKBOARD 301, 618  
MEASURER 142, 143, 144, 454, 455, 456, 457  
MEAT MINCER 528  
MEAT TENDERIZER 157  
MEAT TONG 340  
MENU CARD HOLDER 240  
MENU COVER 310, 314, 315, 316, 317, 318, 319, 320, 321, 322, 323, 324, 325, 326, 327  
MENU HOLDER LECTERN 249, 309  
MESH SKIMMER 115, 341  
MICROWAVE 543, 544  
MILK FROTHER 253, 578  
MINI GRILL 65, 67, 225, 227  
MINI-CUBE 231  
MITTEN 61, 83, 100, 104  
MIXER 512, 513, 514, 515, 517, 518, 519, 520, 521, 522, 523, 524, 525, 526, 588, 589, 590, 591, 592, 593, 595  
MIXING BOWL 147, 460  
MORTAR 158  
MOSKITO KILLER 622, 623, 624  
MULTIFUNCTION ROBOT 533

### N

NAPKIN HOLDER 240, 449  
NOZZLES 478, 479  
NUT CRACKER 248

### O

OIL CAN 234  
OIL SPRAYER 234  
ONE PIECE CROSS SPOOM 114  
ORDER HOLDER 317, 318  
ORDER RALL 130  
OUSTER OPENNER 248, 331  
OVAL CASSEROLE 60, 61, 64, 66, 67, 223, 224, 226, 227  
OVEN 542  
OVEN TRAY 30

### P

PAIL 147  
PARMESAN BOWL 238, 240, 364  
PASTA COOKER 35, 39  
PASTA MEASURER 162  
PASTRY BAG 477  
PASTRY DISPLAY 136, 464  
PASTRY MOULD 486, 487, 488, 489, 490, 491, 492, 493, 495, 496, 497, 498, 501  
PASTRY RACK 482  
PEELER 127, 330, 331, 332, 333  
PERFORATED CONTAINER 410, 411  
PERFORATED LADLE 114, 199  
PERFORATED RINGS 501  
PERFORATED SPATULA 114, 116, 117, 121, 122, 123, 124, 125, 126, 128  
PERFORATED SPOON 114, 116, 117, 118, 121, 122, 125, 199  
PERSONAL BOTTLE 274, 275  
PESTLE 158  
PINAFORE 100  
PIZZA CUTTER 134, 340  
PIZZA FLAT SCOOP 134  
PIZZA MOULD 496  
PIZZA SPATULA 134  
PLATE 193, 195, 203, 424, 425  
PLATE COVER 239, 390, 425  
PORTIONNER 168, 169, 474, 475  
POTATO MASHING MACHINE 156, 157  
POURER 57, 62, 222  
PRESSURE COOKER 69, 70, 71, 72  
PUDDING MOILD 493, 495, 496

### R

RACK 439, 440, 441  
RACK FOR DOUS VIDE 608  
RECLLETTE 550  
RESERVED SIGNAL 240  
RICE COOKER 506  
RINGS 495, 500, 501  
ROASTER 25, 30, 95, 96, 97  
ROLL DISPENSER 449  
ROLL HOLDER 598  
ROLLING PIN 468, 469  
ROTISSERIE 79  
ROUND 21, 24, 27, 29, 61, 62, 63, 79, 83, 107, 108, 109, 110, 111, 222, 231  
ROUND DISH 33, 35, 37, 39, 41, 43, 45, 53, 55  
ROUNDED SAUCEPAN 29

### S

SALAD BOWL 238  
SALAMANDER 549  
SALAT SCOOP 116  
SALT-PFEFFER SET 233, 234  
SAUCE SYRINGE 166  
SAUCEPAN 21, 25, 27, 29, 33, 34, 37, 38, 40, 42, 43, 44, 46, 47, 48, 50, 53, 55, 57, 59, 61, 62, 79, 115, 222  
SAUSAGE COOKER 508  
SAUSAGE ROASTER 508  
SAUTEUSE 22, 25, 27, 35, 47, 49  
SCALE 176, 177, 178, 179, 180, 457, 619

## EN Alphabetical index

SCISSORS	356	<b>V</b>	
SCRAPER	135, 467, 470	VACUUM BAGS	602
SEAFOOD FORKS	248	VACUUM CANISTERS	602
SELF-SERVICE TRAY	423	VACUUM PACK MACHINE	597, 598, 599, 600, 601
SELF-SERVICE TRAY	423	VEGETABLE DISH	238
SEPARATOR POST	451	VEGETABLES CUTTER	509, 530, 531, 533
SERVICE TROLLEY	420, 421, 422, 425	VINE BUCKET	279, 280, 281, 282, 283
SERVING TABLE	204, 228, 232	VINE RACK	278, 289
SERVING TABLE	231		
SERVING TRAY	187, 190	<b>W</b>	
SHAPE EGG MOULD	141	WAFFLE MAKER	553
SHARKER	235	WALL HANGER	130, 289
SHARPENING	351, 355	WARMING PLATE	378, 397, 557, 560, 575
SHEETS	99, 493, 534	WATER JUG	284, 285, 383, 425
SHELVING	428, 429, 430, 431, 432, 433, 434, 435, 436	WATER WHIPPER	294
SHOVEL	134	WHIPPER	170, 476
SHOVEL FOR FRENCH FRIES	141	WHISK	121, 127, 136, 138, 139, 260, 462, 463, 464, 515
SIEVE	461	WINE AERATOR	299
SILICONE HANDLE	53, 104	WINE COOLER	610, 611, 612
SKEWERSQUARE	130	WINE DRIP STOP RING	299
SKIMMER	114, 115, 116, 117, 118, 119, 120, 121, 122, 123, 127, 128	WINE STAND	278
SLICER	162, 333, 340	WINE TABLE SUPPORT	278
SMOKER	171, 172	WINE VACUUM SEALER	298
SMOKER HOOD	172, 173	WOK	37, 49, 77, 80, 82, 88, 92, 396, 547
SOAP WALL DISPENSER	443, 444	WOOD CHIPS	174
SOUP-TUREEN	238		
SOUS VIDE	606, 607	<b>Y</b>	
SOUS VIDE INSULATION BALLS	608	YOGHURT MAKER	510, 511
SPAGUETTI SERVER	117, 118, 120, 121, 122, 123, 128		
SPATULA	120, 123, 124, 126, 133, 136, 137, 250, 464, 465		
SPATULA	114, 117, 118, 119, 121, 123, 125, 132, 133, 134, 136, 137, 331, 464, 465		
SPICE COOKER	151		
SPINNER	164, 165		
SPLITTING GUIDES	412		
SPOON	114, 116, 117, 118, 119, 120, 121, 122, 123, 124, 125, 126, 128, 137, 199, 202, 465		
SPOON HOLDER UTENSILS	115		
SPOUT FOR WINE	299		
SQUEEZE BOTTLE	167, 480		
SQUEEZER	160, 161, 583, 584, 585, 586, 588		
STEAM CASSEROLE	23, 35, 37, 39, 41, 43, 45, 47, 151		
STEAM COOKER	535		
STEAMER	151		
STOCK POT	21, 24, 27, 29, 32, 34, 36, 38, 40, 42, 44, 46, 50, 55, 450, 548		
STRAINER	35, 39, 41, 43, 45, 115, 149, 150, 294		
STRAWS	591		
STUFFING NEEDLE	166		
SUGAR BOWL	240, 261		
<b>T</b>			
TABLE BIN	241, 446, 447		
TABLE NUMBERS	240, 287		
TABLE RUNNER	211		
TABLECLOTH PROTECTOR	214, 215		
TABLECLOTHS PEGS	240		
TEA POT	261, 262		
TERMO JUG	269, 270		
THERMO	271, 272		
THERMOMETER	129, 181, 182, 183		
THERMOTRANS	419		
TICKET HOLDER	317, 318		
TOASTER	391, 392, 393, 579, 580, 581, 582		
TONG	98, 123, 244, 245, 246, 247, 248, 249, 250, 293, 413, 482		
TONGS	98, 245, 248, 263, 413		
TOOLS	470		
TOOTHPICK	233		
TRAY	423		
TRAY	186, 187, 188, 189, 192, 193, 194, 195, 196, 197, 198, 200, 201, 202, 203, 241		
TRAY STAND	187		
TRIANGLE	150		
TRING	495		
TUBULAR SHELF	422		

<b>A</b>		CAMPANULA DEFUMADORA	172, 173
ABERTO-OSTRAS	248, 331	CANECA CILÍNDRICA	29, 35, 37, 39, 41, 43, 45, 47
ABRE-LATAS	331, 358	CAPA PROTECTORA CARRO	421
ABRIDOR DE GARRAFAS	295	CARIMBOS PARA BOLACHAS	470
AÇUCAREIRO	240, 261	CARRO SERVIÇO	420, 421, 422, 425
AERÓGRAFO	471, 556	CENTRIFUGADORA	164, 165
AFIADOR DE FACAS	358, 359, 620	CEPILHO PARA TÁBUA DE CORTE	367
AGRAFADORA	163	CESTA	439, 440, 441
AGULHA DE MECHAR	166	CESTA	230, 231
AIR POT	271, 382, 573	CESTA DE PÃO	216, 217, 218, 219, 220, 386, 387, 388, 389
AIRPOT	382, 573	CESTO PARA FRUTA	220, 389
ANILHA ANTI-GOTA	299	CHAFING DISH	373, 374, 375, 376, 377, 378, 379, 557
AQUECEDOR 397, 398, 399, 558, 559, 560, 561, 626, 627, 628, 629		CHALEIRA	263, 264, 265, 266, 267, 568, 569, 570, 571
AQUECEDOR CHAFING	378, 557	CHÁVENA	424
AQUECEDOR DE LÍQUIDOS	380	CHOCOLATEIRA	555
ARDÓSIA	299, 300, 301, 310, 618	CINZEIRO	241, 450
AREJADOR DE VINHO	299	CLOCHE PARA PRATOS	239, 390, 425
ARGAMASSA	158	CLOQUE PARA QUEIJO/TARTES	239
ARMÁRIO ESTERILIZADOR	611, 612, 621	COADOR	35, 39, 41, 43, 45, 115, 149, 150, 294
ARMÁRIO REFRIGERADOR	610, 611, 612	COBERTO	368
ARO	495, 500, 501	COLHER COCKTAIL	295
ARO PERFURADO	501	COLHER LISA 114, 116, 117, 118, 119, 120, 121, 122, 123, 124, 125, 126, 128, 137, 199, 202, 465	
ARROZEIRA	506	COLHER OBLÍQUA	114
ASA DE SILICONE	53, 104	COLHER PARA MEL	248
ASSADEIRA	25, 30, 95, 96, 97	COLHER PERFURADA	114, 116, 117, 118, 121, 122, 125, 199
ASSADOR DE SALSICHAS	508	COLHER RECOLHE UTENSÍLIOS	115
ATRIL PORTA-MENU	249, 309	CONCHA 114, 116, 117, 118, 119, 120, 121, 122, 123, 126, 128, 199	
AVENTAL	100	CONCHA PARA MOLHO	116, 117, 118, 121, 122, 129
AZEITEIRA	234	CONCHA PERFURADA	114, 199
<b>B</b>		CONJUNTO DE UTENSÍLIOS PARA PREPARAR COCKTAILS	290
BACIA 144, 145, 146, 193, 195, 198, 199, 200, 201, 202, 238, 424, 425, 456, 458, 459		COOKINGME	504, 505
BACIA	147, 460	COPO	200, 273, 287, 425
BACIA CÔNICA	147, 460	COPOS PARA TALHERES	130
BACIA DA ENSALADA	238	COPOS PARA TALHERES	287, 369
BALANÇA	176, 177, 178, 179, 180, 457, 619	COPOS/CÁLICES	286, 287
BALDE	147	CORDÃO DE COURO	314
BANDEJA	423	CORRE MESA	211
BANDEJA / TRAVESSA 186, 187, 188, 189, 192, 193, 194, 195, 196, 197, 198, 200, 201, 202, 203, 241		CORREDOR	293, 457
BANDEJA DE AUTO-ATENDIMENTO	423	CORRENTE	495
BANDEJA DE AUTO-ATENDIMENTO	423	CORTA VEGETALES	509, 530, 531, 533
BANDEJA DE SERVIR	187, 190	CORTADOR 152, 153, 330, 331, 333, 336, 337, 338, 339, 531	
BANDEJA FORNO	30	CORTADORA DE FIAMBRE	529
BANDEJA ISOTÉRMICA	424	CORTA-MASSAS	469
BANHO-MARIE	25, 27, 481, 554, 559	CORTA-PIZZA	134, 340
BARRA FIXAÇÃO NOTAS	130	COZEDOR DE ESPECIARIAS	151
BATEDEIRA 512, 513, 514, 515, 517, 518, 519, 520, 521, 522, 523, 524, 525, 526, 528, 530, 531, 532, 533, 535		COZE-MASSAS	35, 39
BATEDOR 121, 127, 136, 138, 139, 260, 462, 463, 464, 515		CREMALHEIRA DO VINHO	278, 289
BLADE ARREFECEDORA DE GARRAFAS 279, 280, 281, 282, 283		CREMALHEIRA PARA SOUS VIDE	608
BOBINA DE VÁCUO	602	CREPEIRA	77, 80, 83, 88, 552
BOBINA FILME	448	CUTELO	351
BOMBA VÁCUO	298	<b>D</b>	
BOQUILHA DE SERVIR	299	DECORADOR DE COPOS E TAÇAS	292
BOQUILHAS	478, 479	DEFUMADOR	171, 172
BULE	261, 262	DESCAPSULADOR	299
<b>C</b>		DESCAROÇADOR	331, 332, 339
CAÇAROLA 21, 23, 26, 27, 28, 33, 34, 37, 38, 40, 42, 43, 44, 46, 47, 48, 50, 51, 53, 55, 59, 60, 61, 63, 64, 66, 67, 215, 223, 224, 226, 227, 229		DESCASCADOR	162, 333, 340
CAÇAROLA A VAPOR	23, 35, 37, 39, 41, 43, 45, 47, 151	DESCASCADOR	127, 330, 331, 332, 333
CAÇAROLA ALTA	20, 24, 26, 28	DESFOLHADOR DE ERVAS	153, 338
CAÇAROLA ALTA DIREITE	21, 25, 27, 29	DESIDRATADOR	534, 535
CAÇAROLA BAIXA	51, 59	DISIFICADOR LICOR	294
CAÇAROLA BOJUDA	29	DISPENSADOR DE SABÃO	443, 444
CAÇAROLA CÔNICA	22, 25	DISTRIBUIDOR DE PASTELERÍA	168, 474
CAÇAROLA DIREITE 21, 25, 27, 29, 33, 34, 37, 38, 40, 42, 43, 44, 46, 47, 48, 50, 53, 55, 57, 59, 61, 62, 79, 115, 222		DISTRIBUIDOR ZUMOS	380
CAÇAROLA OVAL	60, 61, 64, 66, 67, 223, 224, 226, 227	DOSIFICADOR	235, 384, 385, 448
CAFÉ TIPO FILTRO	574, 575	DOSIFICADOR	168, 169, 474, 475
CAFETEIRA	254, 255, 256, 257, 258, 259, 261, 576, 577	DSECADOR DE MÃO	445
CAIXA	206, 207, 408, 410, 411, 412, 413, 414, 415, 416, 417	DUPLÓ FUNDO	412, 414, 415
CAIXA CONDIMENTOS	161	<b>E</b>	
CAIXA PERFURADA	410, 411	EARREFECEDOR DE GARRAFAS	277
CAIXAS VÁCUO	602	ESCORREDOR	35, 39, 41, 43, 45, 148
CAMPAINHA	241	ESCORREDOR PARA PRATOS	445

## PT Índice alfabético

ESCORRE-FRITOS	148	LIQUIDIFICADORAS	587
ESCOVA APANHA-MIGALHAS	241, 447	LUVA	100, 101, 102, 103, 349
ESCUMADEIRA	114, 115, 116, 117, 118, 119, 120, 121, 122, 123, 127, 128	<b>M</b>	
ESCUMADEIRA	115, 341	MAÇO	294
ESFERAS ISOLANTES SOUS VIDE	608	MALA CHEF	352
ESMAGA-ALHOS	331	MALETA DE CHURRASCO	250
ESPÁTULA	120, 123, 124, 126, 133, 136, 137, 250, 464, 465	MANDOLINA	344, 345
ESPÁTULA DE BOLOS	116, 331	MANGA DE PASTELERIA	477
ESPAZULA DE PEIXE	114, 120, 121	MANTEIGUEIRA	239
ESPÁTULA LISA	114, 117, 118, 119, 121, 123, 125, 132, 133, 134, 136, 137, 331, 464, 465	MÁQUINA DE COZER OVOS	507
ESPÁTULA PERFURADA	114, 116, 117, 121, 122, 123, 124, 125, 126, 128	MÁQUINA DE COZER SALSICHAS	508
ESPÁTULA PERFURADA	116	MÁQUINA DE FAZER GELO	614, 615
ESPÁTULA PIZZA	134	MAQUINA DE FAZER GOFFRES	553
ESPÁTULA PIZZA	134	MÁQUINA DE VACÚO	597, 598, 599, 600, 601
ESPETO MORUNO	130	MÁQUINA PARA ENCHER SALSICHAS MANUAL	163
ESPETOS PARA MARISCO	248	MÁQUINA PARA ENFRIAR COPAS	617
ESPREMEDOR	160, 161, 583, 584, 585, 586, 588	MÁQUINA PARA FAZER GELADO	509, 615
ESpumador de leite	253, 578	MÁQUINA/PERCOLADOR DE CAFÉ	381, 573
ESTANTE	428, 429, 430, 431, 432, 433, 434, 435, 436	MARCADOR DE BOLOS	482
EXPOSITOR PASTELERIA	136, 464	MARCADORES ARDÓSIA	301, 618
<b>F</b>		MARTELO	157
FACA	250, 330, 331, 332, 350, 351, 352, 353, 354, 355	MARTELO ABLANDADOR	157
FARINHEIRO	148	MATA MOSQUITOS	622, 623, 624
FECHO PARA BANDEJAS	425	MEDIDOR	142, 143, 144, 454, 455, 456, 457
FERRAMENTAS	470	MEDIDOR OARA MACARRAO	162
FIO DE COZINHA	99	MICROONDAS	543, 544
FONDUE	221	MINI GRILL	65, 67, 225, 227
FONTE CHOCOLATE	398, 556	MINI-CUBO	231
FORMA FLAN	493, 495, 496	MOINHO	236, 237, 252, 572
FORMA PARA SALGADOS	157	MOLDE OVO	141
FORNO	542	MOLDE PARA BOMBONS	499
FRANÇÊS CAÇAROLA	22, 25	MOLDE PARA HAMBÚRGUERES	159
FRIGIDEIRA	22, 25, 27, 35, 47, 49	MOLDE PASTELERIA	486, 487, 488, 489, 490, 491, 492, 493, 495, 496, 497, 498, 501
FRITEIDEIRA	537, 538, 539, 540, 541	MOLDE PIZZA	496
FUNIL	151, 299	MOLHEIRA	238
FUSIL	351, 355	NINHOS DE ARAME	115
<b>G</b>		NÚMEROS PARA TABELA	240, 287
GANCHOS	130, 352	<b>O</b>	
GARFO	114, 116, 117, 118, 119, 124, 125, 250, 351, 354	ORGANIZADOR ACCESSÓRIOS COCKTAILS	292
GARRAFA	167, 480	ORGANIZADOR DE CAFÉ	383
GARRAFA DECORÇÃO	167, 480	<b>P</b>	
GARRAFA DOSEADORA	57, 62, 222	PÁ	134
GARRAFA PESSOAL	274, 275	PÁ PARA FRITAS FRANCAS	141
GARRAS DE URSOPARA CARNE	155, 335	PAELHEIRA	21, 24, 27, 29, 61, 62, 63, 79, 83, 107, 108, 109, 110, 111, 222, 231
GEL COMBUSTÍVEL	221, 242, 380	PAELHEIRA GÁS BUTANO	111
GRELHA	151	PALHINHAS	591
GRELHA	98, 413, 494	PALITEIRO	233
GRELHA PASTELERIA	482	PANELA	21, 24, 27, 29, 32, 34, 36, 38, 40, 42, 44, 46, 50, 55, 450, 548
GRELHADOR	79	PANELA BAIXA	21, 24
GRELHADOR	53, 59, 83, 86, 88	PANELA DE COCÇÃO	535
GRELHADOR	549, 551	PANELA DE PRESSÃO	69, 70, 71, 72
GUARDANAPO	240, 449	PANELA SUPER ALTA	34, 38, 40, 42, 44, 47
GUIA DIVISÓRIA	412	PAPELEIRA	241, 446, 447
<b>I</b>		PARTE-NOZES	248
INDICADOR RESERVADO	240	PASSA-PURÉ	156, 157
IOGURTEIRA	510, 511	PÉ PORTA BALDES	278
ISQUEIRO	242	PEGAS	61, 83, 100, 104
<b>J</b>		PEIXEIRA	30
JARRA DE ÁGUA	284, 285, 383, 425	PENEIRA	461
JARRA TERMO	269, 270	PENTE DE DECORAÇÃO	470
JOGO DE COZINHA	118	PICADORA	154, 155, 334, 335, 527
JOGO GALHETEIRO	233, 234	PICADORA DE CARNE	528
JOGO SALEIRO-PIMENTEIRO	233, 234	PICADORA DE GELO	293, 616
<b>L</b>		PILÃO P/ALMOFARIZ	158
LÂMINA	99, 493, 534	PILÃO P/PASSADOR CHINÊS	149
LÂMPARA CALOR	398, 400, 401, 558, 562, 563	PINÇA	98, 123, 244, 245, 246, 247, 248, 249, 250, 293, 413, 482
LEGUMEIRA	238	PINÇA PARA TOALHAS	240
LEITEIRA	260, 261	PINÇA/PENTE CORTA-CARNE	340
		PINÇAS	98, 245, 248, 263, 413
		PINCEL	123, 127, 136, 137, 140, 250, 464, 465, 466

PIPETA PARA MOLHO	166	TACO FACAS	351, 352
PISTOLA PASTELERÍA	480	TALHERES	213, 369, 390
PLACA AQUECIMENTO	378, 397, 557, 560, 575	TAMPA	22, 25, 27, 30, 33, 35, 37, 39, 41, 43, 45, 47, 49, 53, 55, 57, 59, 69, 81, 96
PLACA DE FORNO	98, 494	TAMPA PARA CAIXA	412, 413, 414, 415
PLACA DE INDUÇÃO	373, 374, 375, 376, 394, 395, 396, 545, 546, 547	TAMPÃO	299
PLACA VITROCERÂMICA	393, 544	TAPETE	99, 493
PLANCHA GRILL	80, 83, 84, 548	TAPETE PARA COCKTAILS	291
POLVILHADOR	235	TARTEIRA	33, 35, 37, 39, 41, 43, 45, 53, 55
PORTA COMANDAS	317, 318	TENAZ MARISCOS	248
PORTA FATURAS	317, 318	TERMO	271, 272
PORTA MENU	310, 314, 315, 316, 317, 318, 319, 320, 321, 322, 323, 324, 325, 326, 327	TERMÓMETRO	129, 181, 182, 183
PORTA-CUBOS GELO	282, 293	TESOURAS	356
PORTA-ROLOS	449	THERMOTRANS	419
PORTA-TARTE	197, 482	TOALHA DE MESA INDIVIDUAL	209, 210, 211, 212
POSTE SEPARADOR	451	TORRADEIRA	391, 392, 393, 579, 580, 581, 582
POUSA-COPOS	188	TRIÂNGULO	150
POUSA-GARRAFAS	188	TRITURADOR MANUAL DE TOMATE	156, 340
PRATELEIRA TUBULAR	422		
PRATO	193, 195, 203, 424, 425	<b>V</b>	
PRATO CAMPING	188	VITRINA EXPOSITORA	302, 303, 304, 305, 306, 402, 403, 404, 405, 564, 565, 566, 567
PRATO DE OVOS	188		
PROTECTOR DE TOALHAS	214, 215	<b>W</b>	
PULVERIZADOR	234	WOK	37, 49, 77, 80, 82, 88, 92, 396, 547
<b>Q</b>			
QUEIJEIRA	238, 240, 364		
QUEIMADOR	473, 553		
QUEIMADORA A GÁS	472, 473		
<b>R</b>			
RACIONADOR DE GELADO	483, 484		
RALADOR	340, 341, 342, 343		
RASPADOR	135, 467, 470		
RASPADOR DE PEIXE	249		
RECLLETTE	550		
REFRIGERADOR	613		
RELÓGIO DE COZINHA	105, 183		
ROBÔ MULTIFUCIONAIS	533		
ROLO	468, 469		
<b>S</b>			
SACA-ROLHAS	296, 297, 609		
SACOS DE VÁCUO	602		
SALAMANDRA	549		
SEPARADOR DE GORDURAS	234		
SEPARADOR DE OVOS	141		
SERRÍN DE MADEIRA	174		
SERTÁ	33, 39, 47, 49, 53, 55, 57, 59, 62, 74, 75, 76, 77, 78, 79, 82, 85, 86, 87, 88, 89, 90, 91, 92, 93, 222		
SERVIDOR ESPARGUETE	117, 118, 120, 121, 122, 123, 128		
SHARKER	292		
SIFÃO	170, 476		
SIFÃO DE ÁGUA	294		
SOPEIRA	238		
SOUS VIDE	606, 607		
SUPORTE BALDE DE ARREFECEDOR	278		
SUPORTE DE BACIAS	147, 460		
SUPORTE DE BARRA	130, 289		
SUPORTE DE OVO	141		
SUPORTE DE ROLO	598		
SUPORTE DE TAPAS	288, 289		
SUPORTE MAGNÉTICO	357		
SUPORTE MENÚ	240		
SUPORTE PAELHERIA	111		
SUPORTE PARA BANDEJAS	187		
SUPORTE PARA BATEDEIRA BRISK	517, 520		
SUPORTE PRESUNTO	348		
SUPORTE TALHERES	369		
<b>T</b>			
TÁBUA DE CORTE	348, 360, 361, 362, 363, 364, 365, 366, 367		
TÁBUA DE SERVIR	204, 228, 232		
TÁBUA DE SERVIR	231		
TAÇA	483		

CGH-01/23

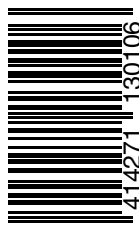

8 414271 130106

# Lacor

**Lacor Menaje Profesional, S.L.**

Bº San Juan, s/n -Apdo. 18

20570 Bergara (Gipuzkoa), Spain

Tel.: (Nacional) 943-76-90-30 / Fax: 943-76-53-87

Tel.: (Export) +34 943-76-91-74 / Fax: +34 943-76-92-22

comercial@lacor.es / export@lacor.es

Grupo Marcos Larrañaga y Cia



[www.lacor.es](http://www.lacor.es)